

OBSOLETE PRODUCT

Last time buy: 04 January 2013

Features:

- ✓ Small size, minimal footprint/low profile
- ✓ 10A Output Current (all voltages)
- ✓ High Efficiency: up to 95%
- ✓ High reliability
- ✓ RoHS Compliant
- ✓ Cost efficient open frame design
- ✓ Pre-bias monotonic start-up
- ✓ +ve Enable Logic and -ve Enable Logic models available

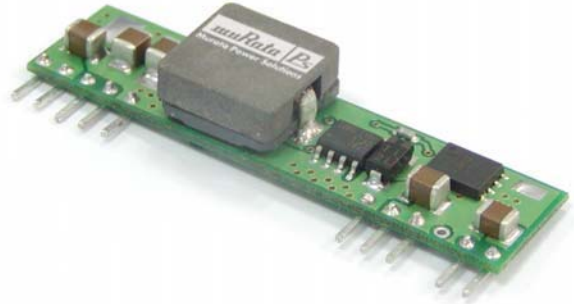

Output				Input				Efficiency	
Vout (V)	Iout (A)	PARD (mVp-p)		Regulation Max		Vin Nom. (V)	Range (V)	Iin TYP (A)	Full Load
		Typ.	Max.	Line	Load				Typ.
1.0	10	30	50	+/-0.2%	+/-0.5%	12	8.3 – 14	0.992	84%
1.2	10	30	50	+/-0.2%	+/-0.5%	12	8.3 – 14	1.163	86%
1.5	10	30	50	+/-0.2%	+/-0.5%	12	8.3 – 14	1.404	89%
1.8	10	30	50	+/-0.2%	+/-0.5%	12	8.3 – 14	1.666	90%
2.0	10	30	50	+/-0.2%	+/-0.5%	12	8.3 – 14	1.832	91%
2.5	10	30	50	+/-0.2%	+/-0.5%	12	8.3 – 14	2.264	92%
3.3	10	30	50	+/-0.2%	+/-0.5%	12	8.3 – 14	2.956	93%
5.0	10	30	50	+/-0.2%	+/-0.5%	12	8.3 – 14	4.385	95%





Murata Power Solutions Volant NEA/NEF010 Series

Non-Isolated 10A SIP DC/DC Converters

Input Characteristics	Notes & Conditions	Min	Typ.	Max	Units
Input Voltage Operating Range		8.3	12	14	Vdc
Input Reflected Ripple Current			200		mA p-p
Inrush Current Transient				0.2	A ² s
Input Filter Type (external)	Low ESR		100		μF
Input Turn ON Threshold			8.5		V
Input Turn OFF Threshold			8.0		V
ON Control	Open Circuit or =Vin				
OFF Control	<0.4VDC				

Output Characteristics	Notes & Conditions	Min	Typ.	Max	Units
Vout Accuracy	100% load	-1.5		+1.5	%
Output Loading		0		10	A
Output Ripple & Noise @ 20Mhz Bandwidth.				50	MVp-p
Maximum Capacitive Load	Low ESR			8000	μF
Vout Trim Range		-10		+10	%
Total Accuracy	Over line/load temperature		<2%		
Current Limit			17		A
Output Line Regulation		-0.2		+0.2	%
Output Load Regulation		+0.5		-0.5	%
Turn-on Overshoot				1	%
SC Protection Technique	Hiccup with auto recovery				
Pre-bias Start-up at output	Unit starts monotonically with pre-bias				

Dynamic Characteristics	Notes & Conditions	Min	Typ.	Max	Units
Load Transient	50% step, 0.1A/μs			100	mV
	Settling Time			200	μs
Frequency			300		KHz
Rise Time	10% Vo to 90% Vo		3.5		ms
Start-Up Time	Vin to Vout and On/Off to Vout Vout rise to monotonic		7		ms

General Specifications	Notes & Conditions	Min	Typ.	Max	Units
MTBF	Calculated (MIL-HDBK-217F)		1.0		x10 ⁶ Hrs
Thermal Protection	Hotspot		110		°C
Operating Temperature	Without derating 100LFM	-40		60	°C
Operating Ambient Temperature	See Power derating curve	-40		85	°C
Dimensions	2"Lx0.327"Wx0.512"H (50.8x8.3x13.0mm)				
Pin Dimensions	0.025" (0.64mm) SQUARE		0.64		mm
Pin Material	Matte Sn Finish on component Leads				
Weight			10		g
Flammability Rating	UL94V-0				

Standards Compliance
CSA C22.2, No.60950/UL 60950, Third Edition (2000), File UL E165113

Thermal Considerations

The power module operates in a variety of thermal environments; however, sufficient cooling should be provided to help ensure reliable operation of the unit. Heat is removed by conduction, convection, and radiation to the surrounding environment. The thermal data presented is based on measurements taken in a set-up as shown in fig 1. when the airflow is parallel to the long axis of the module. The de-rating applies accordingly. The temperature at either location should not exceed 110 °C. The output power of the module should not exceed the rated power for the module (VO, set x IO, max).

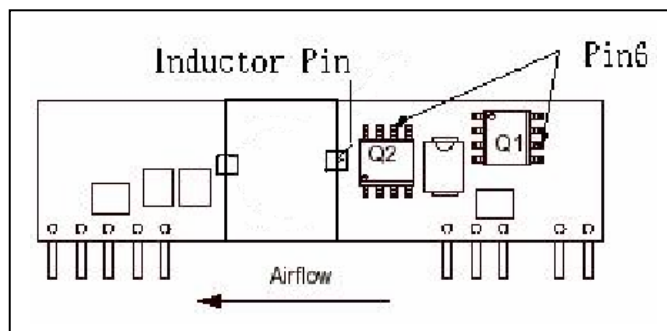

Figure 1: Thermal Measurement Setup

Convection Requirements for Cooling

To predict the approximate cooling needed for the module, refer to the Power Derating Curve in Figure 2 to Figure 9.

These derating curve are approximations of the ambient temperature and airflow required to keep the power module temperature below it's maximum rating. Once the module is assembled in the actual system, the module's temperature should be verified.

Proper cooling can be verified by measuring the power module's temperature at Q1-pin 6 and Q2-pin 6 as shown in Figure 1.

TYPICAL DERATING CURVES

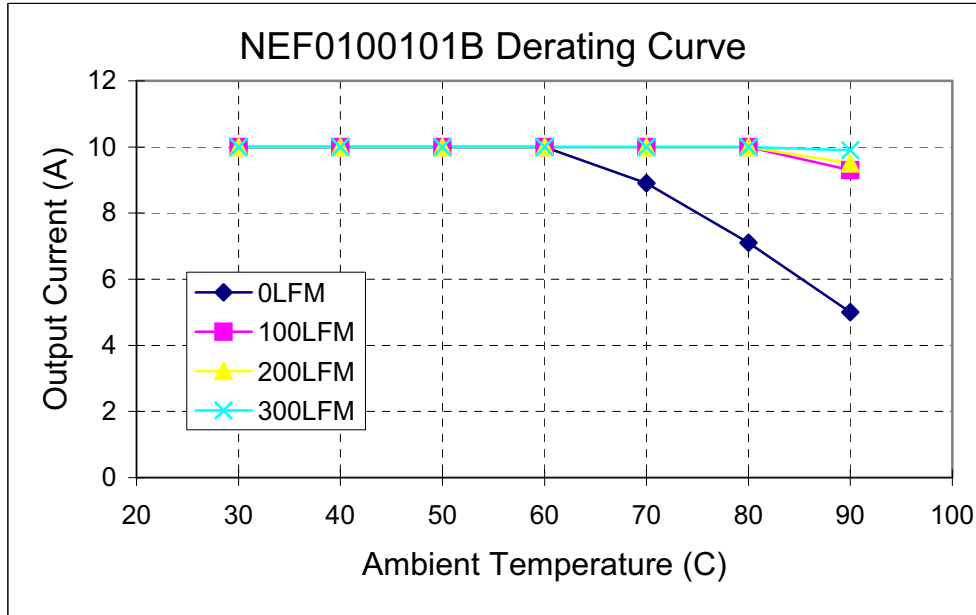

Figure 2. Typical Power Derating vs Output Current for 12Vi and 1.0Vo

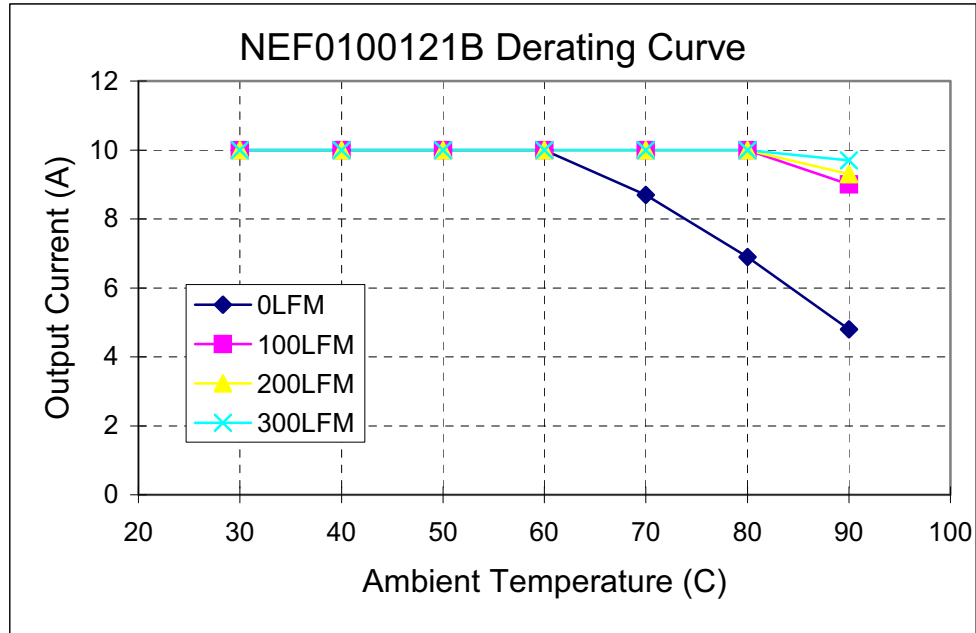

Figure 3. Typical Power Derating vs Output Current for 12Vi and 1.2Vo

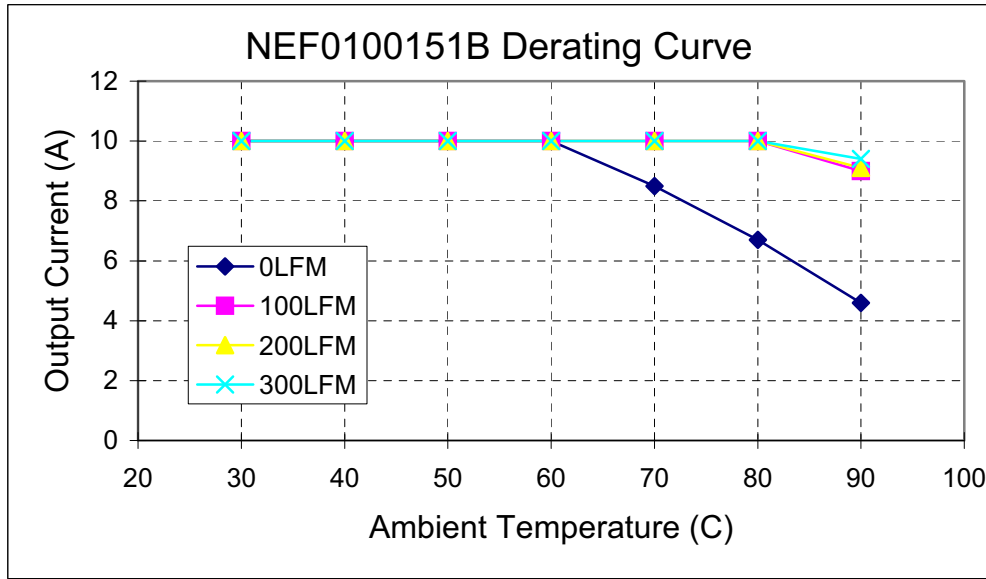

Figure 4. Typical Power Derating vs Output Current for 12Vi and 1.5Vo.

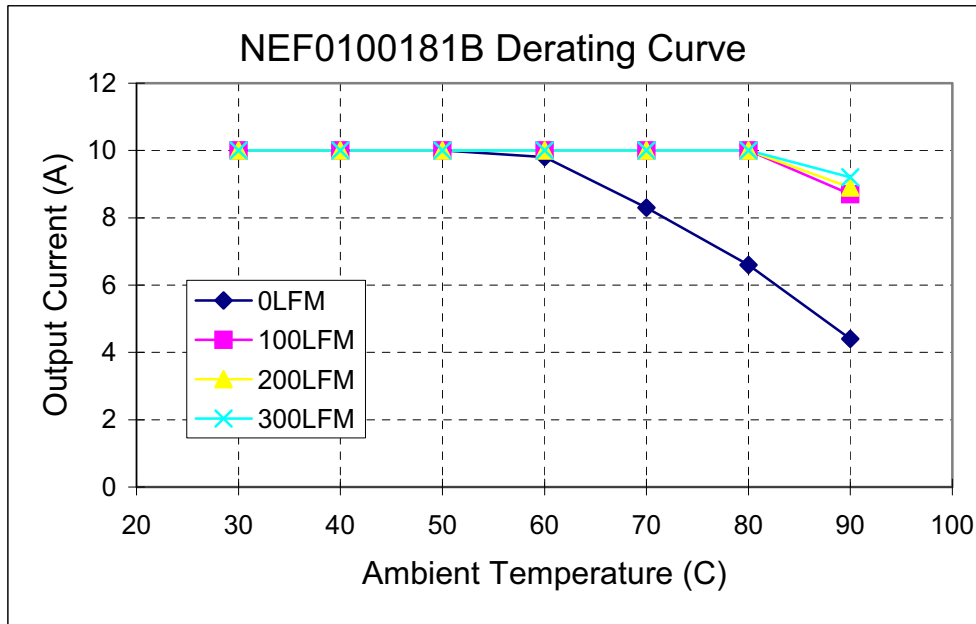

Figure 5. Typical Power Derating vs Output Current for 12Vi and 1.8Vo.

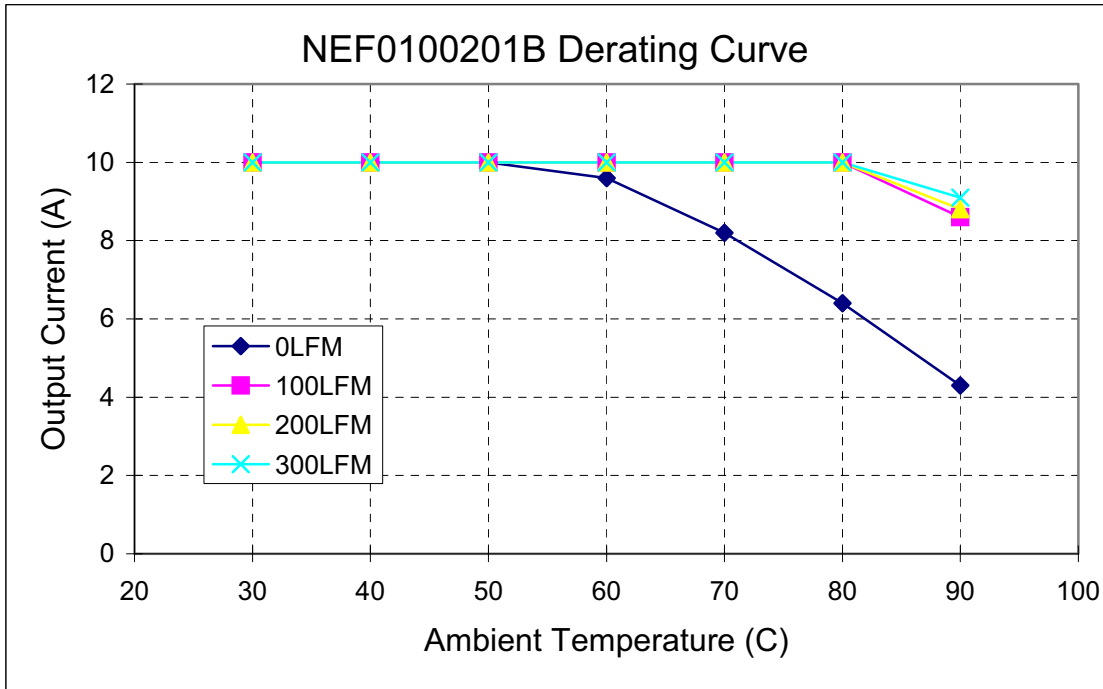

Figure 6. Typical Power Derating vs Output Current for 12Vi and 2.0Vo.

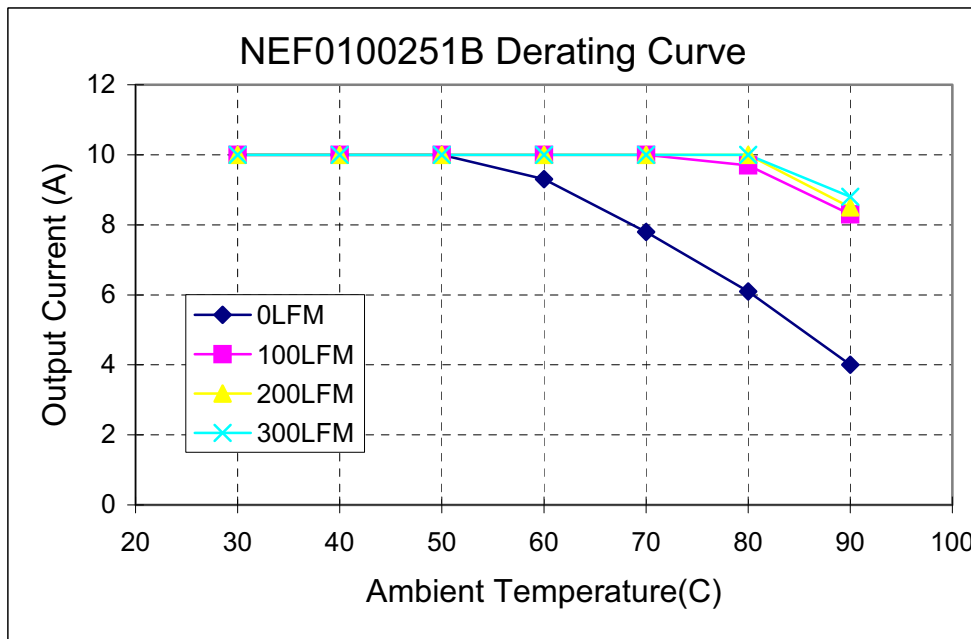

Figure 7. Typical Power Derating vs Output Current for 12Vi and 2.5Vo.

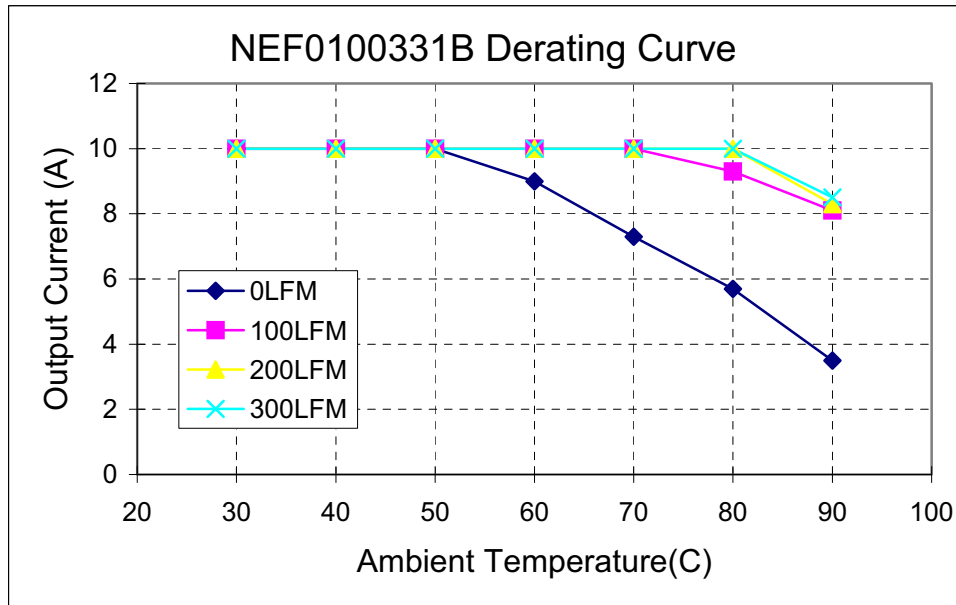

Figure 8. Typical Power Derating vs Output Current for 12Vi and 3.3Vo

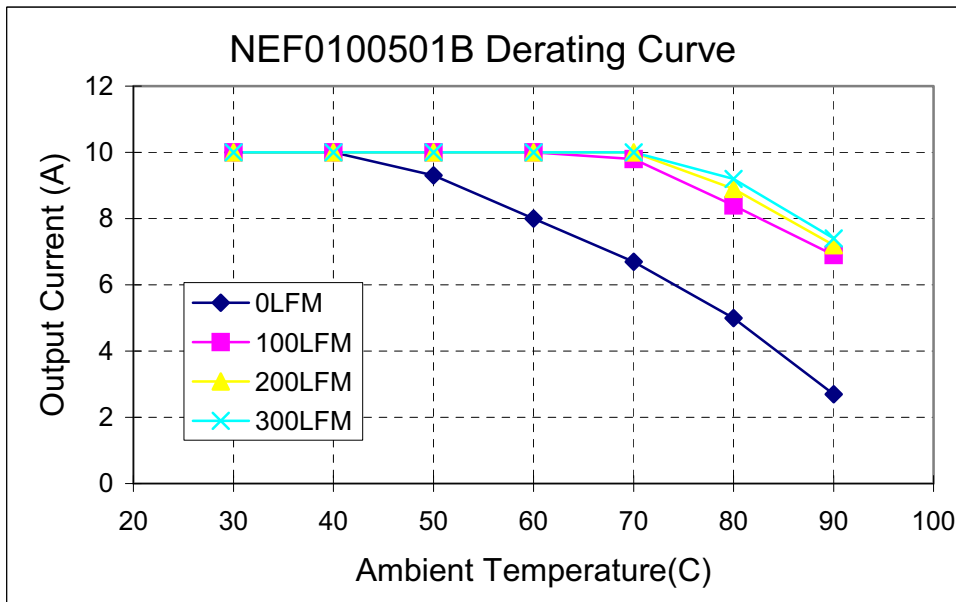

Figure 9. Typical Power Derating vs Output Current for 12Vi and 5.0Vo

TYPICAL EFFICIENCY CURVES

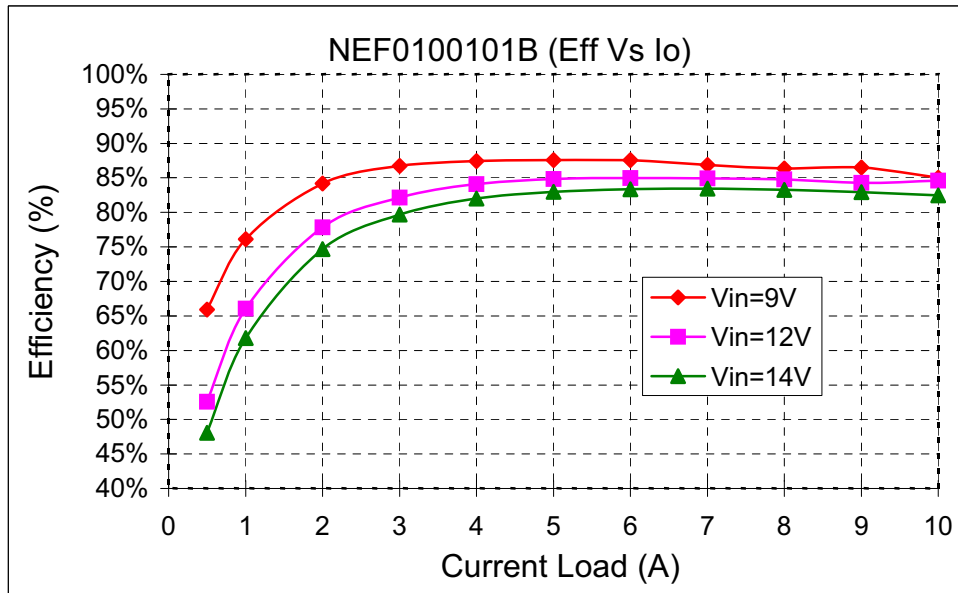

Figure 10. Efficiency Curves for Vout=1.0V (25C)

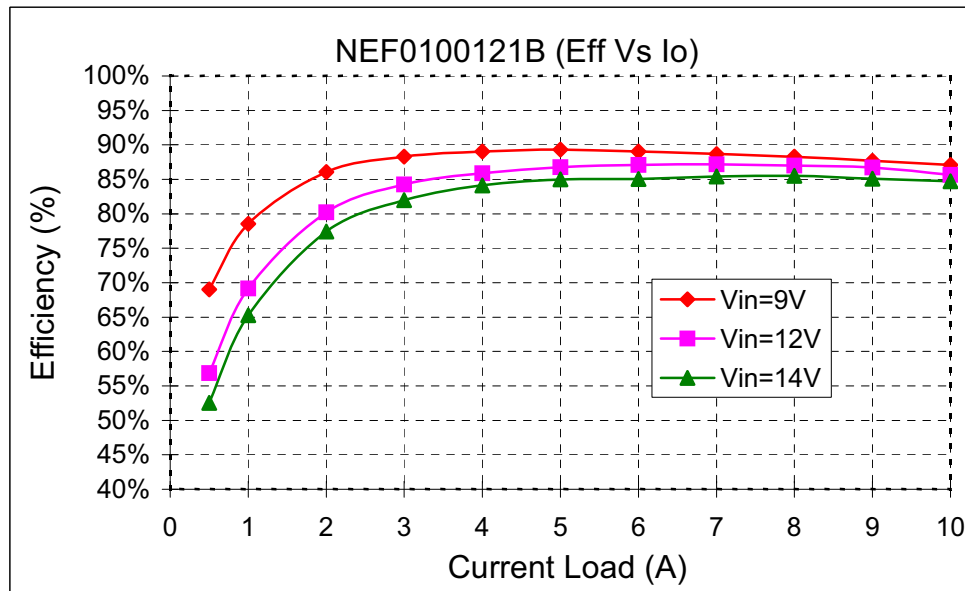

Figure 11. Efficiency Curves for Vout=1.2V (25C)

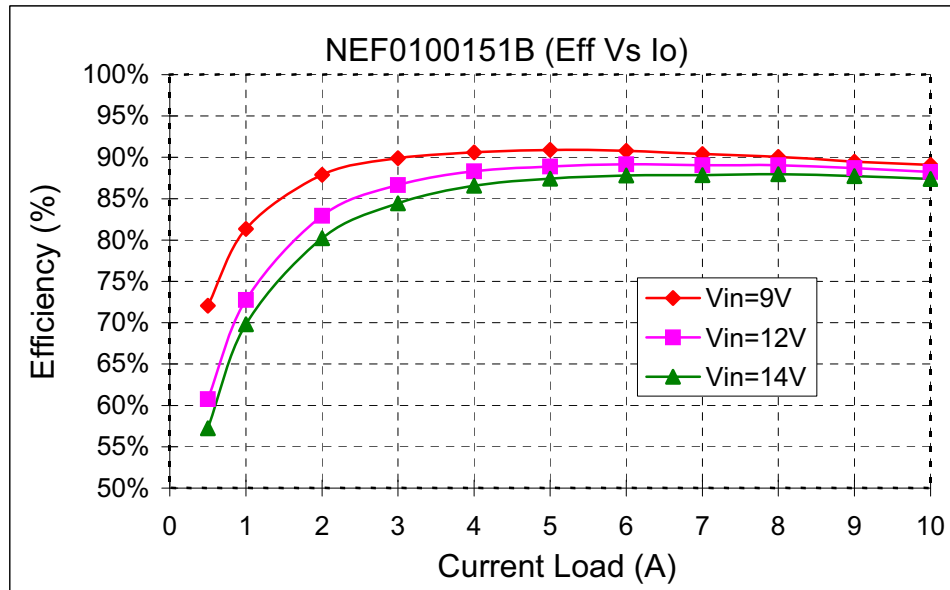

Figure 12. Efficiency Curves for Vout=1.5V (25C)

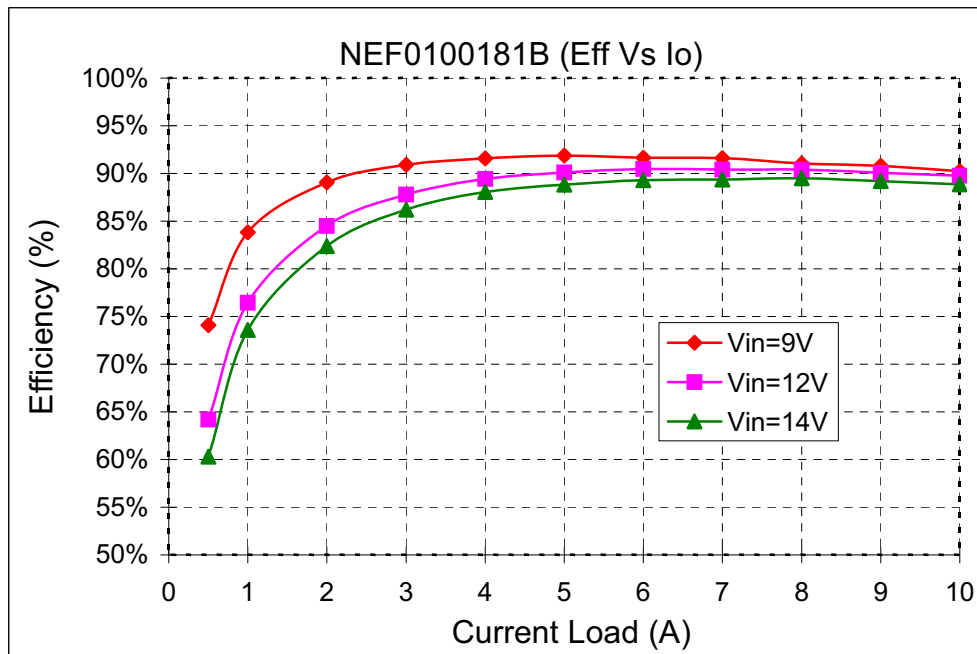

Figure 13. Efficiency Curves for Vout=1.8V (25C)

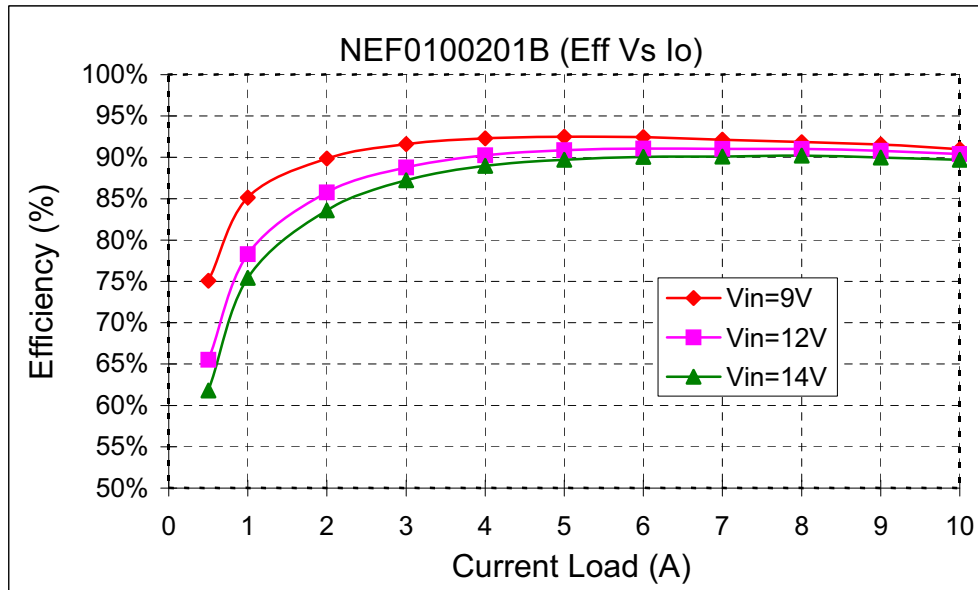

Figure 14. Efficiency Curves for Vout=2.0V (25C)

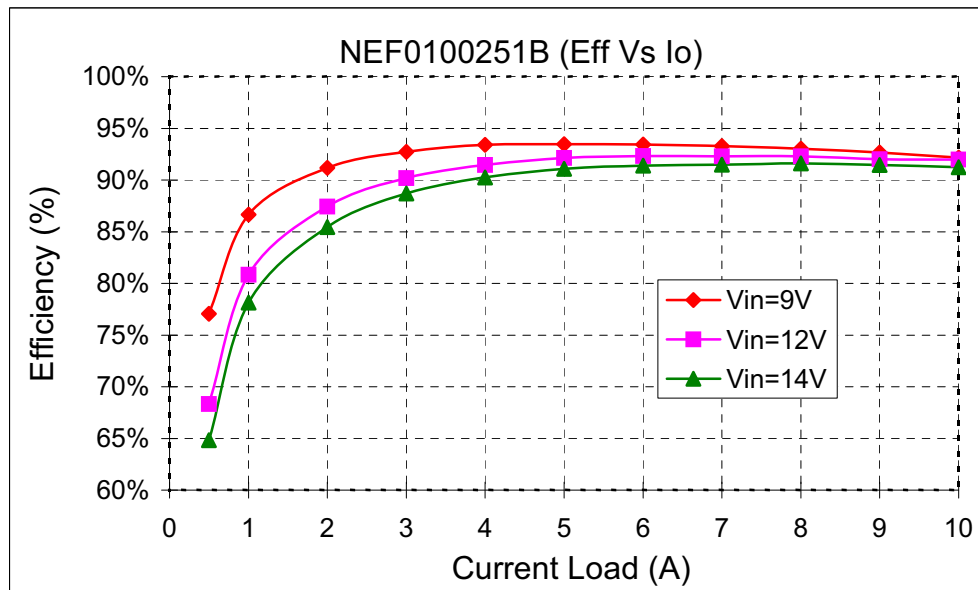

Figure 15. Efficiency Curves for Vout=2.5V (25C)

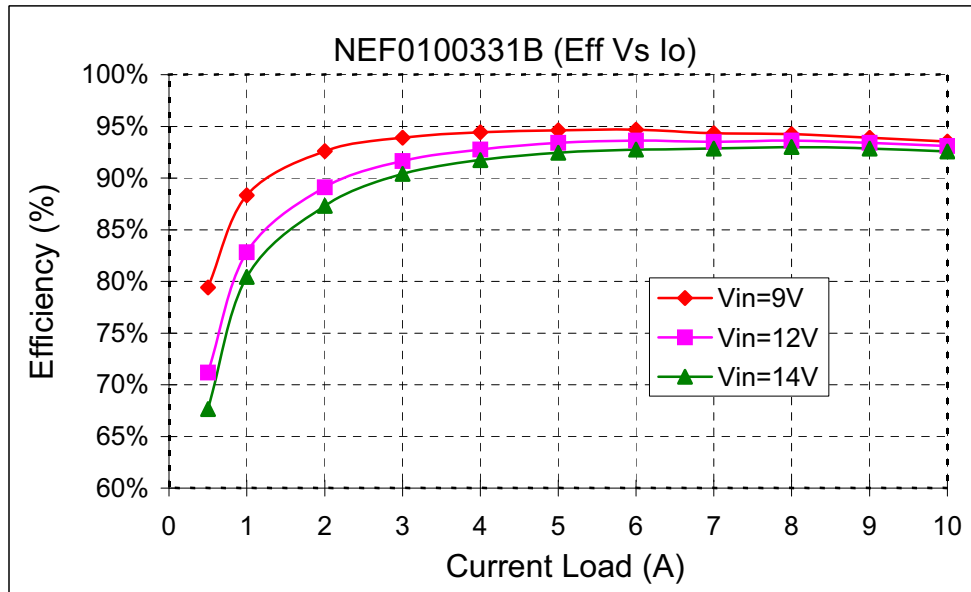

Figure 16. Efficiency Curves for Vout=3.3V (25C)

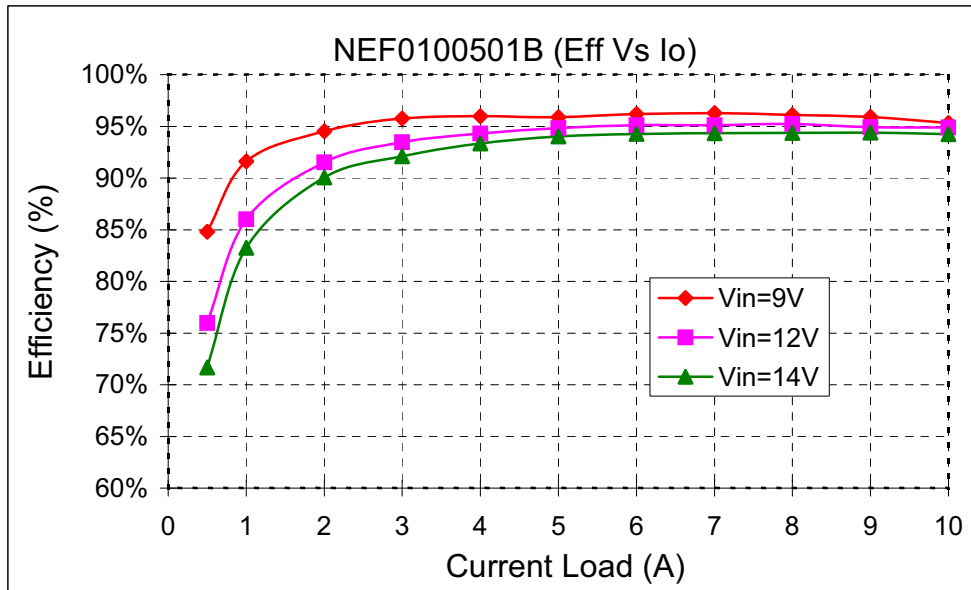
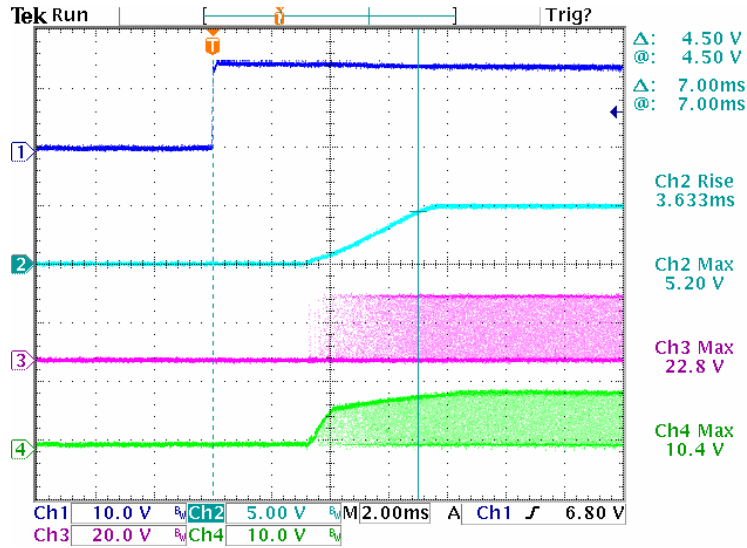

Figure 17. Efficiency Curves for Vout=5.0V (25C)

Typical Start Up

Ch1 : Vin
 Ch2 : Vout
 Ch3 : Top Fet Vg
 Ch4 : Bottom Fet Vg



Typical Start Up with pre-bias

Ch1 : Vin
 Ch2 : Vout
 Ch3 : Output Current

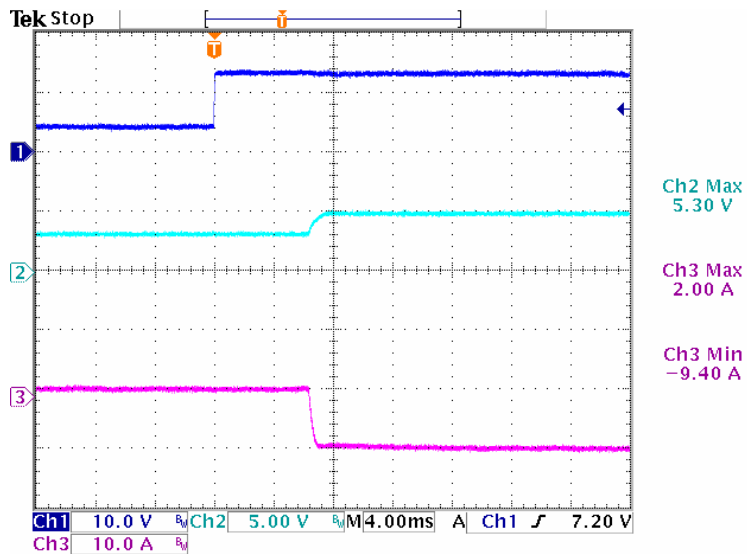

Typical Output Noise and Ripple

Vin = 12Vdc , Vo=5.0V/10A
 Output with 1uF ceramic and 10uF tantalum capacitor

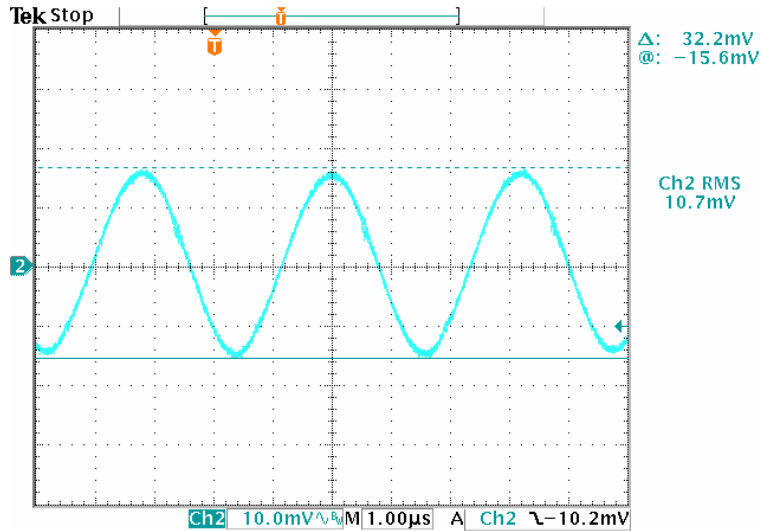

Typical Output Transient Response

Vin = 12Vdc , Vo=5.0V , 50% - 100% - 50% Load change , @0.1A/uS

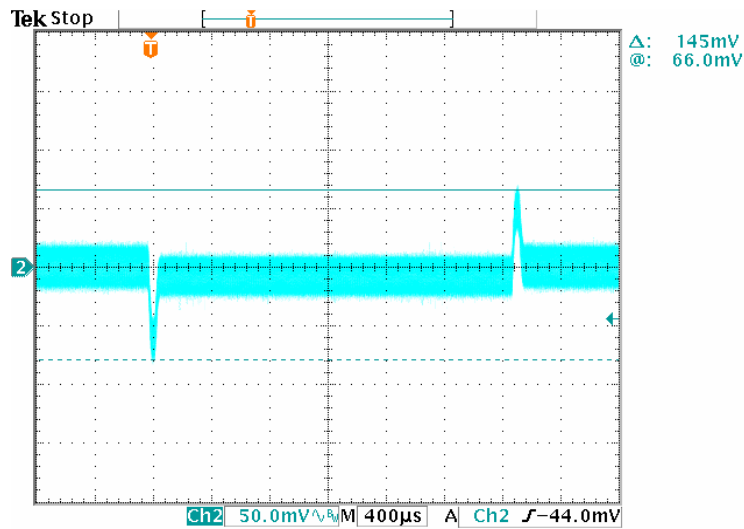

Output Voltage Set point adjustment.

The following relationship establish the calculation of external resistors for the NEF series:

Trim-Up

For trim_Up an external resistor is connected between the TRIM and Ground Pin.

$$R_{trim - up} = \left(\frac{R1 \times 0.7}{V_o - V_{o, nom}} \right) - R_t \text{ (K}\Omega\text{)}$$

Where,

- Rt = 1 KΩ
- R1 = 15 KΩ
- Vo,nom is the nominal output voltage
- Vo is the desired output voltage

Trim_Down

For trim down an external resistor is to be connected between TRIM and Vout pins of the module.

The value of Rtrim_Down is calculated from the following relationship.

$$R_{trim - down} = \frac{R1 \times (V_o - 0.7)}{V_{o, nom} - V_o} - R_t \text{ (K}\Omega\text{)}$$

The values of R1 , Rt , Vo,num , Vo are as defined above.

Examples:

Vout = 1.5V Trim_Up required 8% to 1.62V

$$V_o - V_{o,nom} = 1.62 - 1.5 = 0.12V$$

$$R_{trim - up} = \frac{15 \times 0.7}{0.12} - 1 = 86.5 \text{ (K}\Omega\text{)}$$

Vout = 1.5V Trim_Down required 8% to 1.38V

$$V_{o,nom} - V_o = 1.5 - 1.38 = 0.12V$$

$$R_{trim - down} = \frac{15 \times (1.38 - 0.7)}{0.12} - 1 = 84 \text{ (K}\Omega\text{)}$$

The following relationship establish the calculation of external resistors for the NEA series:

$$R_{adj} = \left(\frac{15 \times 0.7}{V_o - 0.7525} \right) - 1 \text{ (K}\Omega\text{)}$$

For Vout setting an external resistor is connected between the TRIM and Ground Pin.

Resistor values for different output voltages are calculated as given in the table:

Vo, set (Volts)	RAdj (KΩ)
0.75	Open
1.2	22.46
1.5	13.05
1.8	9.024
2.0	7.417
2.5	5.009
3.3	3.122
5.0	1.472

Remote Sense:

All Murata Power Solutions SIP power modules offer an option for remote sense. The remote sense compensates for any distribution drops to accurately control voltage at the point of load. The voltage between the sense pin to Vout pin should not exceed 0.5V.

SMT Lead free Reflow profile

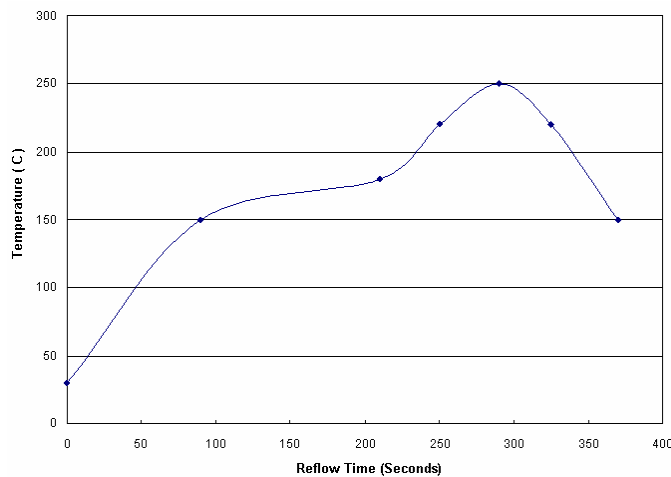

1. Ramp up rate during preheat : 1.33 °C/Sec (From 30°C to 150°C)
2. Soaking temperature : 0.29 °C/Sec (From 150°C to 180°C)
3. Ramp up rate during reflow : 0.8 °C/Sec (From 220°C to 250°C)
4. Peak temperature : 250°C, above 220°C 40 to 70 Seconds
5. Ramp up rate during cooling : -1.56 °C/Sec (From 220°C to 150°C)

Mechanical Information

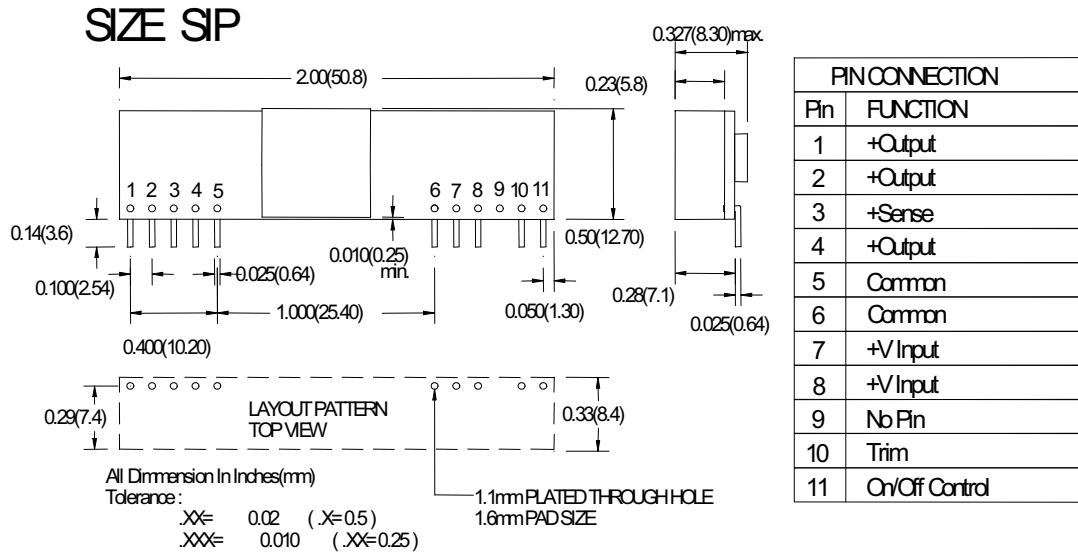

Safety Considerations

The NEA/NEF series of converters are certified to IEC/EN/CSA/UL 60950. If this product is built into information technology equipment, the installation must comply with the above standard. An external input fuse (no more than 20 Amps, recommended) must be used to meet the above requirements. The output of the converter [Vo(+)/Vo(-)] is considered to remain within SELV limits when the input to the converter meets SELV or TNV-2 requirements. The converters and materials meet UL 94V-0 flammability ratings.

Ordering Information

Note: SMT versions are also available. See applicable datasheet for details.

Part Number	Vin	Vout	Iout	Enable Logic	Pin Length
NEF0100101B0C	8.3V - 14.0V	1.0V	10A	Positive	0.139"
NEF0100121B0C	8.3V - 14.0V	1.2V	10A	Positive	0.139"
NEF0100151B0C	8.3V - 14.0V	1.5V	10A	Positive	0.139"
NEF0100181B0C	8.3V - 14.0V	1.8V	10A	Positive	0.139"
NEF0100201B0C	8.3V - 14.0V	2.0V	10A	Positive	0.139"
NEF0100251B0C	8.3V - 14.0V	2.5V	10A	Positive	0.139"
NEF0100331B0C	8.3V - 14.0V	3.3V	10A	Positive	0.139"
NEF0100501B0C	8.3V - 14.0V	5.0V	10A	Positive	0.139"
NEF0100101S0C	8.3V - 14.0V	1.0V	10A	Positive	SMT
NEF0100121S0C	8.3V - 14.0V	1.2V	10A	Positive	SMT
NEF0100151S0C	8.3V - 14.0V	1.5V	10A	Positive	SMT
NEF0100181S0C	8.3V - 14.0V	1.8V	10A	Positive	SMT
NEF0100201S0C	8.3V - 14.0V	2.0V	10A	Positive	SMT
NEF0100251S0C	8.3V - 14.0V	2.5V	10A	Positive	SMT
NEF0100331S0C	8.3V - 14.0V	3.3V	10A	Positive	SMT
NEF0100501S0C	8.3V - 14.0V	5.0V	10A	Positive	SMT
NEF0100100B0C	8.3V - 14.0V	1.0V	10A	Negative	0.139"
NEF0100120B0C	8.3V - 14.0V	1.2V	10A	Negative	0.139"
NEF0100150B0C	8.3V - 14.0V	1.5V	10A	Negative	0.139"
NEF0100180B0C	8.3V - 14.0V	1.8V	10A	Negative	0.139"
NEF0100200B0C	8.3V - 14.0V	2.0V	10A	Negative	0.139"
NEF0100250B0C	8.3V - 14.0V	2.5V	10A	Negative	0.139"
NEF0100330B0C	8.3V - 14.0V	3.3V	10A	Negative	0.139"
NEF0100500B0C	8.3V - 14.0V	5.0V	10A	Negative	0.139"
NEF0100100S0C	8.3V - 14.0V	1.0V	10A	Negative	SMT
NEF0100120S0C	8.3V - 14.0V	1.2V	10A	Negative	SMT
NEF0100150S0C	8.3V - 14.0V	1.5V	10A	Negative	SMT
NEF0100180S0C	8.3V - 14.0V	1.8V	10A	Negative	SMT
NEF0100200S0C	8.3V - 14.0V	2.0V	10A	Negative	SMT
NEF0100250S0C	8.3V - 14.0V	2.5V	10A	Negative	SMT
NEF0100330S0C	8.3V - 14.0V	3.3V	10A	Negative	SMT
NEF0100500S0C	8.3V - 14.0V	5.0V	10A	Negative	SMT
NEA0101500B0C	8.3V - 14.0V	0.75V – 5.0V	10A	Negative	0.139"
NEA0101500S0C	8.3V - 14.0V	0.75V – 5.0V	10A	Negative	SMT
NEA0101501B0C	8.3V - 14.0V	0.75V – 5.0V	10A	Positive	0.139"
NEA0101501S0C	8.3V - 14.0V	0.75V – 5.0V	10A	Positive	SMT

**NOT RECOMMENDED
FOR NEW DESIGNS**

Recommended Alternatives:
 NEA0101500B0C > OKX-T/10-D12N-C
 NEA0101500S0C > OKY-T/10-D12N-C
 NEA0101501B0C > OKX-T/10-D12P-C
 NEA0101501S0C > OKY-T/10-D12P-C



Label Information

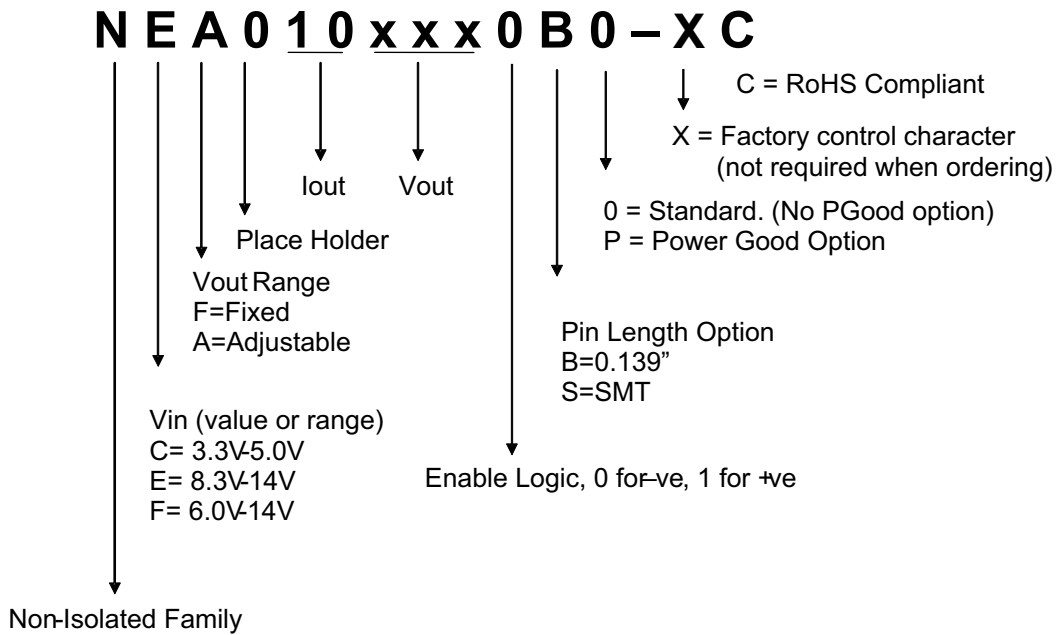

RoHS Compliant

The NEA/NEF010 series of converters is in compliance with the European Union Directive 2002/95/EC (RoHS) with respect to the following substances: lead (Pb), mercury (Hg), cadmium (Cd), hexavalent chromium, polybrominated biphenyls (PBB) or polybrominated diphenyl ethers (PBDE).



Компания «ЭлектроПласт» предлагает заключение долгосрочных отношений при поставках импортных электронных компонентов на взаимовыгодных условиях!

Наши преимущества:

- Оперативные поставки широкого спектра электронных компонентов отечественного и импортного производства напрямую от производителей и с крупнейших мировых складов;
- Поставка более 17-ти миллионов наименований электронных компонентов;
- Поставка сложных, дефицитных, либо снятых с производства позиций;
- Оперативные сроки поставки под заказ (от 5 рабочих дней);
- Экспресс доставка в любую точку России;
- Техническая поддержка проекта, помощь в подборе аналогов, поставка прототипов;
- Система менеджмента качества сертифицирована по Международному стандарту ISO 9001;
- Лицензия ФСБ на осуществление работ с использованием сведений, составляющих государственную тайну;
- Поставка специализированных компонентов (Xilinx, Altera, Analog Devices, Intersil, Interpoint, Microsemi, Aeroflex, Peregrine, Syfer, Eurofarad, Texas Instrument, Miteq, Cobham, E2V, MA-COM, Hittite, Mini-Circuits, General Dynamics и др.);

Помимо этого, одним из направлений компании «ЭлектроПласт» является направление «Источники питания». Мы предлагаем Вам помощь Конструкторского отдела:

- Подбор оптимального решения, техническое обоснование при выборе компонента;
- Подбор аналогов;
- Консультации по применению компонента;
- Поставка образцов и прототипов;
- Техническая поддержка проекта;
- Защита от снятия компонента с производства.



Как с нами связаться

Телефон: 8 (812) 309 58 32 (многоканальный)

Факс: 8 (812) 320-02-42

Электронная почта: org@eplast1.ru

Адрес: 198099, г. Санкт-Петербург, ул. Калинина, дом 2, корпус 4, литера А.