

AXL E IOL AI1 U M12 S

Axioline E IO-Link/analog converter for connecting an analog sensor, 0 V ... 10 V, straight version



Data sheet
8593_en_04

© PHOENIX CONTACT 2015-04-28

1 Description

The IO-Link/analog converter is an IO-Link slave that converts analog signals into the IO-Link protocol.

It therefore offers the option of acquiring the signals of analog sensors via an IO-Link master.

Features

- Straight version
- 1 IO-Link interface
- 1 analog input
- Connection of the sensor in 3-wire technology
- Voltage range: 0 V ... 10 V
- IO-Link and sensor connections via M12 connectors
- FE connection for local connection to functional earth ground
- Supply of the module electronics and the sensor via the IO-Link interface of the IO-Link master
- Diagnostic indicator



Make sure you always use the latest documentation.
It can be downloaded from the product at phoenixcontact.net/products.

2	Table of contents	
1	Description	1
2	Table of contents	2
3	Ordering data	3
4	Technical data	3
5	Additional tables	5
6	Internal circuit diagram	5
7	Pin assignment	6
	7.1 Connections on the device	6
	7.2 Pin assignment of the IO-Link interface	6
	7.3 Pin assignment of the analog input	6
8	Connection notes	6
9	Connection example	6
10	Assembly	7
11	Local status indicator	7
12	Process data	8
	12.1 IN process data	8
	12.2 OUT process data	8
	12.3 Parameterization via OUT process data	9
	12.4 Example for changing from S7-compatible (default) to IB IL and for forming 16-sample mean value	9
13	Significant values in various formats	10
	13.1 IB IL format	10
	13.2 S7-compatible format	10
14	IO-Link objects	11
	14.1 Overview of the objects	11
	14.2 Parameterization (80 _{hex} : ParaWord)	12

3 Ordering data

Description	Type	Order No.	Pcs. / Pkt.
Axioline E-IO-Link/analog converter for connecting an analog sensor, 0 V ... 10 V, M12 fast connection technology, straight version	AXL E IOL AI1 U M12 S	2700336	1

4 Technical data

Dimensions (nominal sizes in mm)

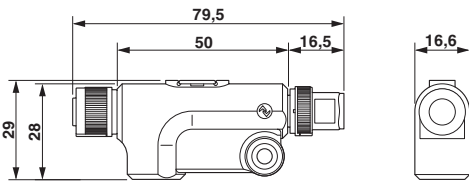

Width	16.6 mm
Height	29 mm
Depth	79.5 mm

General data

Weight	34 g
Ambient temperature (operation)	-25 °C ... 60 °C
Ambient temperature (storage/transport)	-25 °C ... 85 °C
Permissible humidity (operation)	5 % ... 95 %
Permissible humidity (storage/transport)	5 % ... 95 %
Air pressure (operation)	70 kPa ... 106 kPa (up to 3000 m above sea level)
Air pressure (storage/transport)	70 kPa ... 106 kPa (up to 3000 m above sea level)
Degree of protection	IP65/67
Protection class	III, IEC 61140, EN 61140, VDE 0140-1
Pollution degree	2

IO-Link

Specification	V1.1.1
Protection against polarity reversal	Yes
Transmission speed	230,4 kBit/s (COM3)
Frame type	1
Cycle Time	min. 2 ms
Process data update	2 ms
Amount of process data	16 Bit (Input data), 16 Bit (Output data)

IO-Link ports

Number of ports	1
Connection method	M12 connector, A-coded

IO-Link port supply

Typical current consumption	16.5 mA ±15% (at 24 V DC)
Current consumption	max. 120 mA
Protection against polarity reversal	Yes
Short-circuit protection	Yes
Overload protection	Yes
I/O supply voltage	24 V DC This supply voltage is provided via the IO-Link interface of the IO-Link master.
Sensor supply voltage	24 V DC (max. 100 mA) This supply voltage is provided via the I/O supply voltage.

Analog input

Number of inputs	1 (voltage)
Connection method	M12 connector, A-coded
Connection method	3-conductor
Voltage input signal	0 V ... 10 V
Input resistance of voltage input	min. 100 kΩ
Resolution A/D	12 bit
Data formats	IB IL, S7-compatible
Filtering	None or mean-value generation over 4, 16, or 32 measured values
Precision	< 0.25% (From the measuring range final value in the nominal range)
Permissible cable length	max. 30 m (shielded cable)

Error messages to the higher level control or computer system

Overrange or underrange	Message in the diagnostic code (in the IB IL format)
Measured value invalid/no valid measured value present	Message in the diagnostic code (in the IB IL format)
Module faulty	Message in the diagnostic code (in the IB IL format)

Mechanical tests

Vibration resistance in acc. with EN 60068-2-6/IEC 60068-2-6	Operation: 2g
Vibration resistance in acc. with EN 60068-2-6/IEC 60068-2-6	Storage/transport: 5g
Shock in acc. with EN 60068-2-27/IEC 60068-2-27	Operation: 30g, 11 ms, three shocks in each space direction
Shock in acc. with EN 60068-2-27/IEC 60068-2-27	Storage/transport: 50g, 11 ms, three shocks in each space direction
Continuous shock according to EN 60068-2-27/IEC 60068-2-27	10g, 16 ms, 1000 shocks, in all space directions

Approvals

For the latest approvals, please visit phoenixcontact.net/products.

5 Additional tables

The data is valid for nominal operation (supply voltage = 24 V) in the default configuration (measurement range 0 V ... 10 V).

Tolerance and temperature response at $T_A = -25^\circ\text{C}$ to $+60^\circ\text{C}$	
Drift	
Typical	Maximum
± 45 ppm/K	± 75 ppm/K

The tolerance values refer to the measuring range final value.

Tolerances influenced by electromagnetic interference			
Type of electromagnetic interference	Standard	Tolerance	Criterion
Electromagnetic fields	EN 61000-4-3/ IEC 61000-4-3	$< \pm 2.0\%$	A
Fast transients (burst)	EN 61000-4-4/ IEC 61000-4-4	$< \pm 1.0\%$	A
Conducted interference	EN 61000-4-6/ IEC 61000-4-6	$< \pm 0.5\%$	A

6 Internal circuit diagram

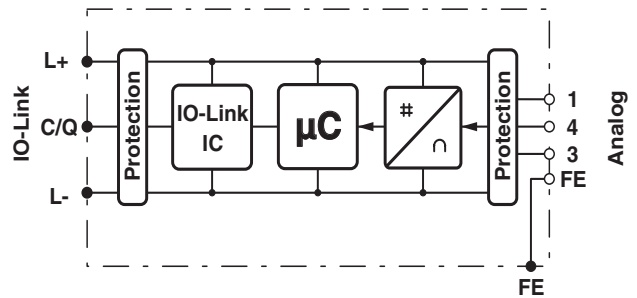
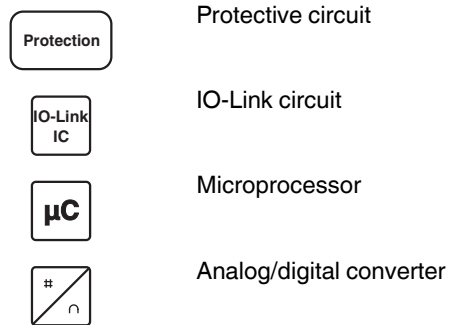

Figure 1 Internal wiring of connections

Key:



7 Pin assignment

7.1 Connections on the device

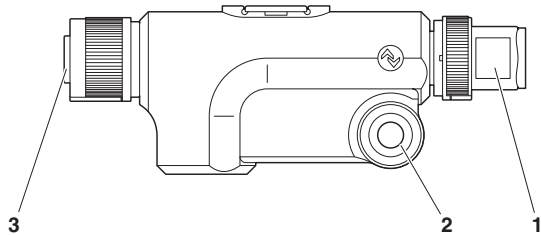

Figure 2 Connections on the converter

No.	Connection
1	IO-Link interface (indicated by IO-Link symbol)
2	Fixing options; options for connection to functional earth ground
3	Analog input

7.2 Pin assignment of the IO-Link interface

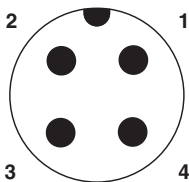

Figure 3 Pin assignment of the I/O link interface (M12 A-coded, pin)

Pin	Signal	Meaning
1	L+	+24 V supply voltage; from IO-Link master
2	-	Not used
3	L-	GND, reference potential for L+
4	C/Q	IO-Link data transmission channel

7.3 Pin assignment of the analog input

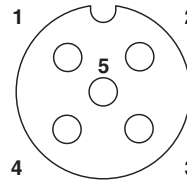

Figure 4 Pin assignment of the analog input (M12 A-coded, socket)

Pin	Assignment
1	+24 V, 100 mA sensor supply
2	Not used
3	GND
4	Voltage input 0 V ... 10 V
5	Not used

8 Connection notes

Always connect the analog sensors using shielded, twisted pair cables.

9 Connection example

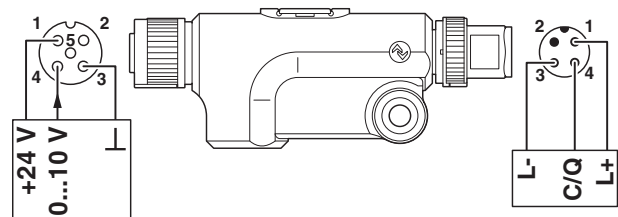

Figure 5 Connection example

10 Assembly

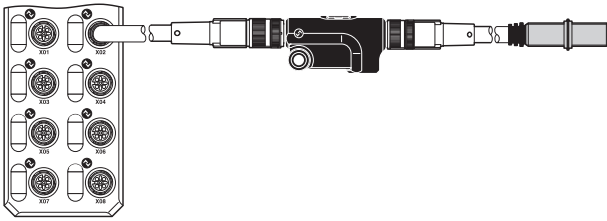

Figure 6 Connection of a sensor to an IO-Link master via the converter

- Connect the IO-Link interface of the converter to an IO-Link port of the higher-level IO-Link master using a standardized 3-pos. cable.
- Connect the analog sensor directly to the analog converter input or using a shielded 4-pos. cable.
- Fasten each connection using the M12 connectors.



In environments with high levels of interference, in particular, Phoenix Contact recommends connecting the converter to an appropriate functional earth ground point using an M4 screw.

11 Local status indicator

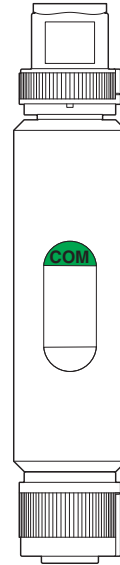

Figure 7 Local status indicator

Designation	Color	Meaning	State	Description
COM	Green	Status of IO-Link device	ON	Supply voltage OK
			Flashing	Supply voltage OK, SDCl communication active
			OFF	No supply voltage, no communication

12 Process data

The device occupies one word of IN process data and one word of OUT process data.

12.1 IN process data

The measured values are depicted in IB IL or S7-compatible format.

For both formats the measured value is represented in bits 14 to 3. Bit 15 is available as a sign bit. Bits 2 to 0 are not relevant for the measured value.

15	14	13	12	11	10	9	8	7	6	5	4	3	2	1	0
V	Analog value											x	x	x	

V Sign bit (= 0, not relevant)

x Not relevant for the measured value (are set to 0)

A diagnostic code is mapped to the input data in the event of an error.

IB IL format

The values $> 8000_{\text{hex}}$ and $< 8100_{\text{hex}}$ indicate an error.

Code (hex)	Cause
8001	Measuring range exceeded (overrange)
8002	Wire break
8004	Measured value invalid/no valid measured value available
8040	Device faulty

S7-compatible format

In the format S7-compatible exist two diagnostic codes, see the following table.

Code (hex)	Cause
7FFF	Overrange
8000	Wire break

12.2 OUT process data

The device can be configured via the process data output word.

The following configurations are possible:

- Selection of formats for representing measured values
- Setting mean-value generation

15	14	13	12	11	10	9	8	7	6	5	4	3	2	1	0
Reserved						Filter		Reserved		Format		Reserved			



For the exact meaning of the individual bits, please refer to "Parameterization (80_{hex}: ParaWord)".

12.3 Parameterization via OUT process data

Reparameterization can be carried out via the output process data, however this is not saved permanently on the device.



Please operate the reparameterization only by the startup of the device!

The following sequence applies regardless of the format (IB IL or S7-compatible):

- The master sends parameter data (OutputProcessData with bit 15 = 1)



In order to start configuration, bit 15 of the output word must be set to 1. If bit 15 = 0, the default configuration is active.

- The device interrupts the transmission of current process data and responds with the following diagnostic code in the process data:

Code (hex)	Cause
8800	Parameter OK
8801	Parameter ERROR

- If the diagnostic code is OK, the parameter data is accepted immediately. The master can end parameterization (OutputProcessData with bit 15 = 0). The device returns to normal operation with cyclic process data transmission.
- In the event of the ERROR diagnostic code, the master can abort parameterization without modified parameter data (OutputProcessData with bit 15 = 0) or transmit the modified parameterization (return to step 1).

12.4 Example for changing from S7-compatible (default) to IB IL and for forming 16-sample mean value

The example applies to the following changes:

- Selection of format S7-compatible (Default) to IB IL
- For forming 16-sample mean value

15	14	13	12	11	10	9	8	7	6	5	4	3	2	1	0
Configuration	Reserved					Filter		Reserved		Format		Reserved			
1	Reserved					1	0	Reserved		1	0	Reserved			

13 Significant values in various formats

13.1 IB IL format

Resolution: 1 bit (0000 -> 0008) accords 2.67 V

Input data		Range	0 V ... 10 V
hex	dec		V
8001	32769	Overrange	> 10.837
7EF8	32511	Overdrive range (End)	10.837
7538	30008	Overrange (Start)	10.000267
7530	30000	Nominal range (End)	10.0
3A98	15000	Nominal range	5.0
0008	8	Nominal range	0.00267
0000	0	Nominal range (Start)	0
8002	32770	Wire break	

13.2 S7-compatible format

Resolution: 1 bit (0000 -> 0008) accords 2.89 V

Input data		Range	0 V ... 10 V
hex	dec		V
7FFF	32767	Overrange	> 11.756
7EF0	32503	Overdrive range (End)	11.756
6C08	27656	Overrange (Start)	10.00289
6C00	27648	Nominal range (End)	10.0
3600	13824	Nominal range	5.0
0008	8	Nominal range	0.00289
0000	0	Nominal range (Start)	0
8000	32768	Wire break/short circuit	

The value 8000_{hex} is specified in S7-compatible format for all errors for which diagnostic codes 8001_{hex} to 8040_{hex} are output in IB IL format.

14 IO-Link objects

14.1 Overview of the objects

Index (hex)		Object name	Length in bytes	Access	Meaning	Contents
DPP	ISDU					
Identification						
07		Vendor ID	2	R	Manufacturer identification	00 _{hex}
08						B0 _{hex}
09		Device ID	3	R	Device ID	01 _{hex}
0A						00 _{hex}
0B						01 _{hex}
	10	VendorName	Max. 64	R	Manufacturer name	Phoenix Contact
	11	VendorText	Max. 64	R	Notes	www.phoenixcontact.com
	12	ProductName	Max. 64	R	Product designation	AXL E IOL AI1 U M12 S
	13	Product ID	Max. 64	R	Order No.	2700336
	14	ProductText	Max. 64	R	Product text	IO-Link/analog converter voltage input straight
	15	Serial number	Max. 16	R	Serial number	Stored in the production process.
	16	HardwareVersion	Max. 64	R	Hardware version	E.g., 01
	17	FirmwareVersion	Max. 64	R	Firmware version	E.g., 001
Diagnostics						
	20	Error count	2	R	Errors since power up	Number of errors
	28	InputProcessData	2	R	Input process data	Last current data
Parameter						
	80	ParaWord	2	R/W	Parameterization	0000 _{hex}

Abbreviation	Meaning
R	Read
W	Write

14.2 Parameterization (80_{hex}: ParaWord)

Parameterize the device using this object.

In the case of valid parameters, the parameterization is permanently stored on the device.

After a reset, the device operates with the last permanently stored data. Upon delivery, the device operates with the default data (default settings).



Saving data to the device leads to a communication failure of around 30 ms.

15	14	13	12	11	10	9	8	7	6	5	4	3	2	1	0
Reserved						Filter		Reserved		Format		Reserved			

In the following tables the values in **bold** are default settings.

Format	
Code (bin)	Meaning
00	S7-compatible
10	IB IL
Other	Reserved

Filter	
Code (bin)	Meaning
00	No filter
01	4-sample mean-value
10	16-sample mean-value
11	32-sample mean-value



Компания «ЭлектроПласт» предлагает заключение долгосрочных отношений при поставках импортных электронных компонентов на взаимовыгодных условиях!

Наши преимущества:

- Оперативные поставки широкого спектра электронных компонентов отечественного и импортного производства напрямую от производителей и с крупнейших мировых складов;
- Поставка более 17-ти миллионов наименований электронных компонентов;
- Поставка сложных, дефицитных, либо снятых с производства позиций;
- Оперативные сроки поставки под заказ (от 5 рабочих дней);
- Экспресс доставка в любую точку России;
- Техническая поддержка проекта, помощь в подборе аналогов, поставка прототипов;
- Система менеджмента качества сертифицирована по Международному стандарту ISO 9001;
- Лицензия ФСБ на осуществление работ с использованием сведений, составляющих государственную тайну;
- Поставка специализированных компонентов (Xilinx, Altera, Analog Devices, Intersil, Interpoint, Microsemi, Aeroflex, Peregrine, Syfer, Eurofarad, Texas Instrument, Miteq, Cobham, E2V, MA-COM, Hittite, Mini-Circuits, General Dynamics и др.);

Помимо этого, одним из направлений компании «ЭлектроПласт» является направление «Источники питания». Мы предлагаем Вам помощь Конструкторского отдела:

- Подбор оптимального решения, техническое обоснование при выборе компонента;
- Подбор аналогов;
- Консультации по применению компонента;
- Поставка образцов и прототипов;
- Техническая поддержка проекта;
- Защита от снятия компонента с производства.



Как с нами связаться

Телефон: 8 (812) 309 58 32 (многоканальный)

Факс: 8 (812) 320-02-42

Электронная почта: org@eplast1.ru

Адрес: 198099, г. Санкт-Петербург, ул. Калинина, дом 2, корпус 4, литера А.