



FCIconnect.com

Copyright FCI.

List of "SFW__R-1/2STE1LF" customer document

| DOCUMENT NO. | LIST |
|--------------|---|
| SC-SFW10 | SPEC. |
| JSA95854 | CAT.NO.TABLE FOR 1mm SPACING SMT CONNECTOR (SFW__R-1/2ST__LF) |
| JSA95855 | 1mm SPACING SMT CONNECTOR (SFW__R-1ST__LF) |
| JSA95856 | 1mm SPACING SMT CONNECTOR (SFW__R-2ST__LF) |
| JSA95857 | CAT.NO.TABLE FOR PLASTIC TAPE PACKAGED 1mm SPACING SMT CONNECTOR (SFW__R-1/2STE1LF) |
| JSA95858 | PLASTIC TAPE PACKAGED 1mm SPACING SMT CONNECTOR (SFW__R-1STE1LF) |
| JSA95859 | PLASTIC TAPE PACKAGED 1mm SPACING SMT CONNECTOR (SFW__R-2STE1LF) |
| JSA91605 | RECOMMENDED CABLE (FPC) (SFW__R-1/2ST__) |
| JSA91604 | RECOMMENDED CABLE (FFC) (SFW__R-1/2ST__) |
| GS-20-129 | HANDLING PROCEDURES |

| | | | | | | | | | | | |
|---------------------------|--|----------------|--|--|--|------------|--|---|--|-------------------|--|
| mat'l. code - | | | | surface ISO 1302 <input checked="" type="checkbox"/> 58 / tolerance ISO 406 ISO 1101 | | projection | | product family 58RF | | CODE JP | |
| ltr ecn no dr date | | | | tolerances unless otherwise specified | | mm | | title | | | |
| A J05-0055 H.T '05/2/4 | | | | angles linear | | scale X | | 1mm SPACING FPC/FFC CONNECTOR DOCUMENT LIST | | | |
| B J06-0398 H.T 9/26/'06 | | | | | | | | (Cat. No. : SFW__R-1/2STE1LF) | | | |
| C J09-0358 M.Y 2009-10-5 | | | | | | | | dwg no | | sheet 1 of 1 size | |
| D J09-0380 M.Y 2009-10-27 | | | | dr M. YAMASHITA 2009-10-27 | | | | JSA 96336 | | A4 | |
| | | | | enr M. YAMASHITA 2007-10-27 | | | | type Product Customer Drawing | | | |
| | | | | chr S. Waki 2009-10-27 | | | | | | | |
| | | | | appd J. D. ... 2009-10-27 | | | | | | | |
| sheet index | | revision sheet | | D 1 | | | | | | Rev. D | |



CAT. NO. & DIMENSIONS

| NO. OF CONTACTS (n) | CAT. NO. | DIMENSIONS (NOTE2) | | | |
|---------------------|------------------|--------------------|---------|---------|---------|
| | | A ± 0.2 | B ± 0.2 | C ± 0.2 | D ± 0.1 |
| 4 | SFW4R-1/2ST__LF | 9.8 | 8.6 | 3.0 | 5.3 |
| 5 | SFW5R-1/2ST__LF | 10.8 | 9.6 | 4.0 | 6.3 |
| 6 | SFW6R-1/2ST__LF | 11.8 | 10.6 | 5.0 | 7.3 |
| 7 | SFW7R-1/2ST__LF | 12.8 | 11.6 | 6.0 | 8.3 |
| 8 | SFW8R-1/2ST__LF | 13.8 | 12.6 | 7.0 | 9.3 |
| 9 | SFW9R-1/2ST__LF | 14.8 | 13.6 | 8.0 | 10.3 |
| 10 | SFW10R-1/2ST__LF | 15.8 | 14.6 | 9.0 | 11.3 |
| 11 | SFW11R-1/2ST__LF | 16.8 | 15.6 | 10.0 | 12.3 |
| 12 | SFW12R-1/2ST__LF | 17.8 | 16.6 | 11.0 | 13.3 |
| 13 | SFW13R-1/2ST__LF | 18.8 | 17.6 | 12.0 | 14.3 |
| 14 | SFW14R-1/2ST__LF | 19.8 | 18.6 | 13.0 | 15.3 |
| 15 | SFW15R-1/2ST__LF | 20.8 | 19.6 | 14.0 | 16.3 |
| 16 | SFW16R-1/2ST__LF | 21.8 | 20.6 | 15.0 | 17.3 |
| 17 | SFW17R-1/2ST__LF | 22.8 | 21.6 | 16.0 | 18.3 |
| 18 | SFW18R-1/2ST__LF | 23.8 | 22.6 | 17.0 | 19.3 |
| 19 | SFW19R-1/2ST__LF | 24.8 | 23.6 | 18.0 | 20.3 |
| 20 | SFW20R-1/2ST__LF | 25.8 | 24.6 | 19.0 | 21.3 |
| 21 | SFW21R-1/2ST__LF | 26.8 | 25.6 | 20.0 | 22.3 |
| 22 | SFW22R-1/2ST__LF | 27.8 | 26.6 | 21.0 | 23.3 |
| 23 | SFW23R-1/2ST__LF | 28.8 | 27.6 | 22.0 | 24.3 |
| 24 | SFW24R-1/2ST__LF | 29.8 | 28.6 | 23.0 | 25.3 |
| 25 | SFW25R-1/2ST__LF | 30.8 | 29.6 | 24.0 | 26.3 |
| 26 | SFW26R-1/2ST__LF | 31.8 | 30.6 | 25.0 | 27.3 |
| 27 | SFW27R-1/2ST__LF | 32.8 | 31.6 | 26.0 | 28.3 |
| 28 | SFW28R-1/2ST__LF | 33.8 | 32.6 | 27.0 | 29.3 |
| 29 | SFW29R-1/2ST__LF | 34.8 | 33.6 | 28.0 | 30.3 |
| 30 | SFW30R-1/2ST__LF | 35.8 | 34.6 | 29.0 | 31.3 |

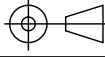
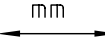

NOTES

1. THIS PRODUCT IS THE CONNECTOR USED FOR FPC/FFC AND COPEs WITH AUTOMATIC MOUNTING (SMT).
2. SEE PART DRAWINGS FOR DIMENSIONS A~D.
3. A  SYMBOL WILL BE NEXT TO ANY DIMENSION, VIEW, OR NOTE WHICH HAS BEEN MODIFIED WITH THE CURRENT DRAWING REVISION.

| | | | | | | | | | | | |
|---------------------------|--|--|--|--|--|--|--|--|--|----------------------|--|
| mat'l. code | | | | surface 58 / tolerance ISO 1302 ISO 406 ISO 1101 | | projection  | | product family 58RF | | CODE JP | |
| ltr ecn no dr date | | | | tolerances unless otherwise specified | | mm  | | title CAT. NO. TABLE FOR 1mm SPACING SMT CONNECTOR (Cat. No. SFW__R-1/2ST__LF) | | | |
| AA J05-0055 H.T 05-02-04 | | | | angles linear | | scale  | | dwg no JSA 95854 | | sheet 1 of 1 size A4 | |
| AB J06-0398 H.T 06-09-26 | | | | dr H. TAKAKURA 06-09-26 | |  | | type Product Customer Drawing | | | |
| AC S08-0276 DGOH 08-08-22 | | | | enr H. TAKAKURA 06-09-26 | | | | | | | |
| | | | | chr DENNIS GOH 08-08-22 | | | | | | | |
| sheet index | | | | revision AC | | appd JOEY NG 08-08-22 | | Rev. AC | | | |

This document is the property of and embodies CONFIDENTIAL and PROPRIETARY information of FCI. No part of the information shown on this document may be used in any way or disclosed to others without the written consent of FCI. Copyright FCI.



FCIconnect.com



A

A

B

B

C

C

D

D

This document is the property of and embodies CONFIDENTIAL and PROPRIETARY information of FCI. No part of the information shown on this document may be used in any way or disclosed to others without the written consent of FCI. Copyright FCI.



FCIconnect.com



| PT. NO. | PARTS NAME | MATERIAL | Q'TY | NOTE |
|---------|----------------|--------------------------------------|------|---------------|
| 1 | HOUSING | PPS RESIN GLASS REINFORCED (UL94V-0) | 1 | COLOR : BROWN |
| 2 | SLIDER | | 1 | COLOR : BLACK |
| 3 | CONTACT | PHOSPHOR BRONZE | n | PLATING : TIN |
| 4 | MOUNTING PLATE | | 2 | |

n : NO. OF CONTACTS

NOTES

1. THIS PRODUCT IS THE CONNECTOR USED FOR FPC/FFC AND COPES WITH AUTOMATIC MOUNTING (SMT).
 2. FLATNESS FOR CONTACT TERMINAL HOUSING MUST BE WITHIN TOLERANCE IN Z PORTION DETAILED DRAWING.
 3. THIS PRODUCT IS LOWER CONTACT TYPE CONNECTOR.
 4. THIS PRODUCT MEETS EUROPEAN UNION DIRECTIVES AND OTHER COUNTRY REGULATIONS AS DESCRIBED IN GS-22-008
 5. THE HOUSING WILL WITHSTAND EXPOSURE TO 260°C PEAK TEMPERATURE FOR 10 SECONDS IN A REFLOW SOLDERING OVEN.
3. A SYMBOL WILL BE NEXT TO ANY DIMENSION, VIEW, OR NOTE WHICH HAS BEEN MODIFIED WITH THE CURRENT DRAWING REVISION.

RECOMMENDED PC BOARD LAYOUT (COMPONENT SIDE)



| | | | | | | | | | | | |
|-------------|--|---------------------------------|--|------------------------------|--|------------|--|---------------------|--|---|--|
| mat'l. code | | surface 58 / tolerance ISO 1302 | | tolerance ISO 406 / ISO 1101 | | projection | | product family 58RF | | CODE JP | |
| ltr | | ecn no | | dr | | date | | title | | 1mm SPACING SMT CONNECTOR (Cat. No. SFW__R-1ST__LF) | |
| AA | | J04-0180 | | H.T | | 04-07-02 | | mm | | scale X | |
| AB | | J05-0055 | | H.T | | 05-02-04 | | dwg no | | sheet 1 of 1 size | |
| AC | | J05-0736 | | H.T | | 05-10-28 | | JSA 95855 | | A4 | |
| AD | | J06-0398 | | H.T | | 06-09-26 | | type | | Product Customer Drawing | |
| AE | | S08-0276 | | DGOH | | 08-08-22 | | Rev. | | AE | |
| sheet index | | revision sheet | | AE | | 1 | | | | | |

SC_SFW10 JSA95854 form: A4

This document is the property of and embodies CONFIDENTIAL and PROPRIETARY information of FCI. No part of the information shown on this document may be used in any way or disclosed to others without the written consent of FCI. Copyright FCI.



FCIconnect.com



| PT. NO. | PARTS NAME | MATERIAL | Q'TY | NOTE |
|---------|----------------|--------------------------------------|------|---------------|
| 1 | HOUSING | PPS RESIN GLASS REINFORCED (UL94V-0) | 1 | COLOR : BROWN |
| 2 | SLIDER | PPS RESIN GLASS REINFORCED (UL94V-0) | 1 | COLOR : BLACK |
| 3 | CONTACT | PHOSPHOR BRONZE | n | PLATING : TIN |
| 4 | MOUNTING PLATE | | 2 | |

n : NO. OF CONTACTS

NOTES

1. THIS PRODUCT IS THE CONNECTOR USED FOR FPC/FFC AND COPEs WITH AUTOMATIC MOUNTING (SMT).
2. FLATNESS FOR CONTACT TERMINAL HOUSING MUST BE WITHIN TOLERANCE IN Z PORTION DETAILED DRAWING.
3. THIS PRODUCT IS UPPER CONTACT TYPE CONNECTOR.
4. THIS PRODUCT MEETS EUROPEAN UNION DIRECTIVES AND OTHER?COUNTRY REGULATIONS AS DESCRIBED IN GS-22-008
5. THE HOUSING WILL WITHSTAND EXPOSURE TO 260°C PEAK TEMPERATURE FOR 10 SECONDS IN A REFLOW SOLDERING OVEN.
6. A \triangle AE SYMBOL WILL BE NEXT TO ANY DIMENSION, VIEW, OR NOTE WHICH HAS BEEN MODIFIED WITH THE CURRENT DRAWING REVISION.

RECOMMENDED PC BOARD LAYOUT (COMPONENT SIDE)



| | | | | | | | | | |
|---------------------------|--|--|--|------------|--|---|--|-------------------|--|
| mat'l. code | | surface 58 / tolerance ISO 1302 / ISO 406 / ISO 1101 | | projection | | product family 58RF | | CODE JP | |
| ltr ecn no dr date | | tolerances unless otherwise specified ±0.2 | | mm | | title | | | |
| AA J04-0180 H.T 04-07-02 | | angles linear | | mm | | 1mm SPACING SMT CONNECTOR (Cat. No. SFW__R-2ST__LF) | | | |
| AB J05-0055 H.T 05-02-04 | | | | scale X | | dwg no | | sheet 1 of 1 size | |
| AC J05-0736 H.T 05-10-28 | | | | FCI | | JSA 95856 | | A4 | |
| AD J06-0398 H.T 06-09-26 | | dr H. TAKAKURA 06-09-26 | | | | type Product Customer Drawing | | | |
| AE S08-0276 DGOH 08-08-22 | | enr H. TAKAKURA 06-09-26 | | | | | | Rev. AE | |
| | | chr DENNIS GOH 08-08-22 | | | | | | | |
| | | appd JOEY NG 08-08-22 | | | | | | | |
| sheet index | | revision sheet 1 | | | | | | | |

SC_SFW10 JSA95854 form: A4

CAT. NO. & DIMENSIONS

| NO. OF CONTACTS (n) | CAT. NO. (NOTE2) | DIMENSIONS (NOTE3) | | |
|---------------------|-------------------|--------------------|---------|---------|
| | | E ± 5 | F ± 0.3 | G ± 0.1 |
| 4 | SFW4R-1/2STE1 LF | 20.4 | 16 | — |
| 5 | SFW5R-1/2STE1 LF | 28.4 | 24 | — |
| 6 | SFW6R-1/2STE1 LF | 28.4 | 24 | — |
| 7 | SFW7R-1/2STE1 LF | 28.4 | 24 | — |
| 8 | SFW8R-1/2STE1 LF | 28.4 | 24 | — |
| 9 | SFW9R-1/2STE1 LF | 28.4 | 24 | — |
| 10 | SFW10R-1/2STE1 LF | 28.4 | 24 | — |
| 11 | SFW11R-1/2STE1 LF | 28.4 | 24 | — |
| 12 | SFW12R-1/2STE1 LF | 28.4 | 24 | — |
| 13 | SFW13R-1/2STE1 LF | 36.4 | 32 | 28.4 |
| 14 | SFW14R-1/2STE1 LF | 36.4 | 32 | 28.4 |
| 15 | SFW15R-1/2STE1 LF | 36.4 | 32 | 28.4 |
| 16 | SFW16R-1/2STE1 LF | 36.4 | 32 | 28.4 |
| 17 | SFW17R-1/2STE1 LF | 48.4 | 44 | 40.4 |
| 18 | SFW18R-1/2STE1 LF | 48.4 | 44 | 40.4 |
| 19 | SFW19R-1/2STE1 LF | 48.4 | 44 | 40.4 |
| 20 | SFW20R-1/2STE1 LF | 48.4 | 44 | 40.4 |
| 21 | SFW21R-1/2STE1 LF | 48.4 | 44 | 40.4 |
| 22 | SFW22R-1/2STE1 LF | 48.4 | 44 | 40.4 |
| 23 | SFW23R-1/2STE1 LF | 48.4 | 44 | 40.4 |
| 24 | SFW24R-1/2STE1 LF | 48.4 | 44 | 40.4 |
| 25 | SFW25R-1/2STE1 LF | 48.4 | 44 | 40.4 |
| 26 | SFW26R-1/2STE1 LF | 48.4 | 44 | 40.4 |
| 27 | SFW27R-1/2STE1 LF | 48.4 | 44 | 40.4 |
| 28 | SFW28R-1/2STE1 LF | 60.4 | 56 | 52.4 |
| 29 | SFW29R-1/2STE1 LF | 60.4 | 56 | 52.4 |
| 30 | SFW30R-1/2STE1 LF | 60.4 | 56 | 52.4 |



NOTES

1. THIS PRODUCT IS THE CONNECTOR USED FOR FPC/FFC AND COPE WITH AUTOMATIC MOUNTING (SMT).
2. THIS CATALOG NO. INDICATES PLASTIC TAPE PACKAGED CONNECTOR.
3. SEE PART DRAWINGS FOR DIMENSIONS E~G.
4. A SYMBOL WILL BE NEXT TO ANY DIMENSION, VIEW, OR NOTE WHICH HAS BEEN MODIFIED WITH THE CURRENT DRAWING REVISION.

| | | | | | | | | | | | |
|---------------------------|--|------------------|--|--|--|----------------|--|---|--|----------------------|--|
| mat'l. code | | | | surface 58 / tolerance ISO 1302 / ISO 406 / ISO 1101 | | projection | | product family 58RF | | CODE JP | |
| ltr ecn no dr date | | | | tolerances unless otherwise specified | | mm | | title CAT. NO. TABLE FOR PLASTIC TAPE PACKAGED 1mm SPACING SMT CONNECTOR (Cat. No. SFW__R-1/2STE1 LF) | | | |
| AA J05-0055 H.T 05-02-04 | | | | angles linear | | scale \times | | dwg no JSA 95857 | | sheet 1 of 1 size A4 | |
| AB J06-0398 H.T 06-09-26 | | | | dr H. TAKAKURA 06-09-26 | | | | type Product Customer Drawing | | | |
| AC S08-0276 DGOH 08-08-22 | | | | enr H. TAKAKURA 06-09-26 | | | | | | | |
| | | | | chr DENNIS GOH 08-08-22 | | | | | | | |
| | | | | appd JOEY NG 08-08-22 | | | | | | | |
| sheet index | | revision sheet 1 | | AC | | | | | | Rev. AC | |

SC_SFW10 JSA95854 95858 95859

form: A4

This document is the property of and embodies CONFIDENTIAL and PROPRIETARY information of FCI. No part of the information shown on this document may be used in any way or disclosed to others without the written consent of FCI. Copyright FCI.



FCIconnect.com



This document is the property of and embodies CONFIDENTIAL and PROPRIETARY information of FCI. No part of the information shown on this document may be used in any way or disclosed to others without the written consent of FCI. Copyright FCI.



FCIconnect.com



| PT. NO. | PARTS NAME | CAT. NO. | MATERIAL | Q'TY | NOTE |
|---------|-----------------------|----------------|-------------------|-------|--------------------|
| 1 | REEL | _____ | CARDBOARD | 1 | COLOR:WHITE/GREY |
| 2 | PLASTIC (EMBOSS) TAPE | _____ | PET | _____ | COLOR:TRANSPARENCY |
| 3 | COVER | _____ | POLYESTER | _____ | COLOR:TRANSPARENCY |
| 4 | CONNECTOR | SFW__R-1ST__LF | SEE ATTACHED DWG. | 2000 | LOWER CONTACT TYPE |

NOTES

- THIS IS PLASTIC TAPE PACKAGED CONNECTOR USED FOR FPC/FFC AND COPEs WITH AUTOMATIC MOUNTING (SMT).
- SEE JIS C 0806 (PACKING OF ELECTRONIC COMPONENTS ON CONTINUOUS TAPES (SURFACE MOUNTING DEVICES)) FOR SHAPE AND DIMENSIONS OF PLASTIC (EMBOSS) TAPE AND REEL.
- E DIMENSION IS PORTION OF THE CORE.
- A SYMBOL WILL BE NEXT TO ANY DIMENSION, VIEW, OR NOTE WHICH HAS BEEN MODIFIED WITH THE CURRENT DRAWING REVISION.

| | | | | | | | | | |
|---------------------------|--|--|--|------------|--|--|--|-------------------|--|
| mat'l. code | | surface 58 / tolerance ISO 1302 / ISO 406 / ISO 1101 | | projection | | product family 58RF | | CODE JP | |
| ltr ecn no dr date | | tolerances unless otherwise specified | | mm | | title | | | |
| AA J05-0055 H.T 05/02/04 | | angles linear ±5 | | mm | | PLASTIC TAPE PACKAGED 1mm SPACING SMT CONNECTOR (Cat. No. SFW__R-1STE1 LF) | | | |
| AB J06-0398 H.T 06/09/26 | | ±5' | | scale X | | dwg no | | sheet 1 of 1 size | |
| AC S08-0276 DGOH 08-08-22 | | dr H. TAKAKURA 06-09-26 | | | | JSA 95858 | | A4 | |
| | | enr H. TAKAKURA 06-09-26 | | | | type Product Customer Drawing | | | |
| | | chr DENNIS GOH 08-08-22 | | | | | | | |
| | | appd JOEY NG 08-08-22 | | | | | | | |
| sheet index | | revision AC | | | | | | Rev. AC | |
| 1 | | 1 | | | | | | | |

SC_SFW10 JSA95857 form: A4

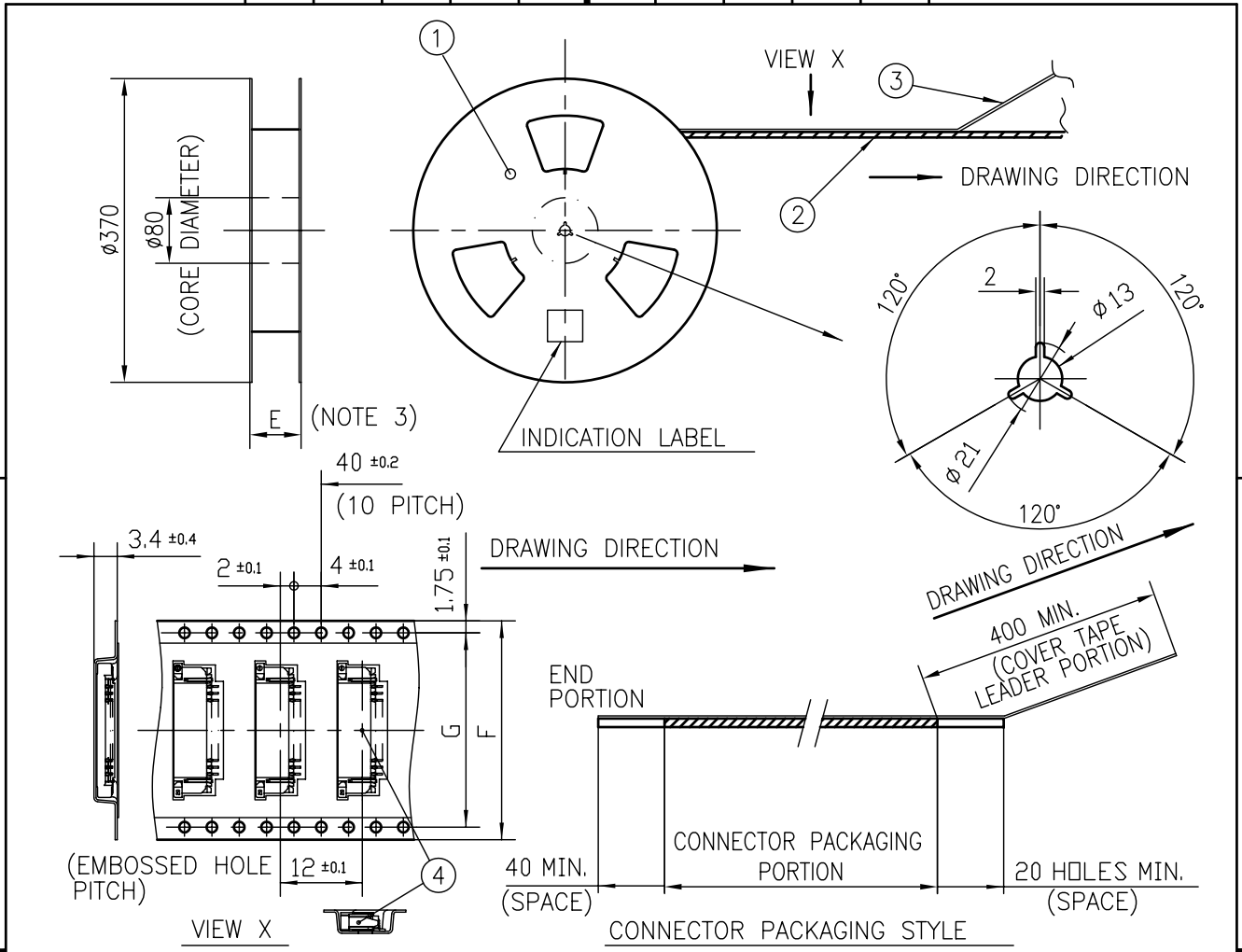

| PT. NO. | PARTS NAME | CAT. NO. | MATERIAL | Q'TY | NOTE |
|---------|-----------------------|----------------|-------------------|-------|--------------------|
| 1 | REEL | _____ | CARDBOARD | 1 | COLOR:WHITE/GREY |
| 2 | PLASTIC (EMBOSS) TAPE | _____ | PET | _____ | COLOR:TRANSPARENCY |
| 3 | COVER | _____ | POLYESTER | _____ | COLOR:TRANSPARENCY |
| 4 | CONNECTOR | SFW__R-2ST__LF | SEE ATTACHED DWG. | 2000 | UPPER CONTACT TYPE |

NOTES

- THIS IS PLASTIC TAPE PACKAGED CONNECTOR USED FOR FPC/FFC AND COPER WITH AUTOMATIC MOUNTING (SMT).
- SEE JIS C 0806 (PACKING OF ELECTRONIC COMPONENTS ON CONTINUOUS TAPES (SURFACE MOUNTING DEVICES)) FOR SHAPE AND DIMENSIONS OF PLASTIC (EMBOSS) TAPE AND REEL.
- E DIMENSION IS PORTION OF THE CORE.
- A SYMBOL WILL BE NEXT TO ANY DIMENSION, VIEW, OR NOTE WHICH HAS BEEN MODIFIED WITH THE CURRENT DRAWING REVISION.

| | | | | | | | | | | | |
|-------------|--|---------------------------------|--|------------------------------|--|----------------------|--|---------------------|--|--|--|
| mat'l. code | | surface 58 / tolerance ISO 1302 | | tolerance ISO 406 / ISO 1101 | | projection | | product family 58RF | | CODE JP | |
| ltr | | ecn no | | dr | | date | | title | | PLASTIC TAPE PACKAGED 1mm SPACING SMT CONNECTOR (Cat. No. SFW__R-2STE1 LF) | |
| AA | | J05-0055 | | H.T | | 05-02-04 | | mm | | dwg no | |
| AB | | J06-0398 | | H.T | | 06-09-26 | | scale | | sheet 1 of 1 | |
| AC | | S08-0276 | | DGOH | | 08-08-22 | | mm | | size | |
| | | | | dr | | H. TAKAKURA 06-09-26 | | FCJ | | JSA 95859 | |
| | | | | enr | | H. TAKAKURA 06-09-26 | | | | A4 | |
| | | | | chr | | DENNIS GOH 08-08-22 | | | | | |
| | | | | appd | | JOEY NG 08-08-22 | | | | | |
| sheet index | | revision | | AC | | | | type | | Product Customer Drawing | |
| 1 | | 1 | | | | | | | | Rev. AC | |

This document is the property of and embodies CONFIDENTIAL and PROPRIETARY information of FCI. No part of the information shown on this document may be used in any way or disclosed to others without the written consent of FCI. Copyright FCI.



FCIconnect.com

RECOMMENDED CABLE (FPC)



n : NO. OF CONDUCTOR



| PT. NO. | PARTS NAME | MATERIAL | THICKNESS (um) |
|---------|-----------------|--------------------------------------|----------------|
| 1 | BASE FILM | POLYIMIDE OR POLYESTER OR EQUAL | 25 |
| 2 | CONDUCTOR | COPPER FOIL(PLATING:SOLDER 1um MIN.) | 35 |
| 3 | OVERLAY | POLYIMIDE OR POLYESTER OR EQUAL | — |
| 4 | SUPPORTING TAPE | POLYESTER OR POLYIMIDE OR EQUAL | 188 |

NOTES

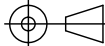
1. NO BURR AT EACH PORTION.
2. NO PEELING IN COMMON USE.
3. TOTAL THICKNESS LIMIT OF EACH MATERIAL (INCLUDING ADHESIVE AGENT) IS SPECIFIED.
4. A  SYMBOL WILL BE NEXT TO ANY DIMENSION, VIEW, OR NOTE WHICH HAS BEEN MODIFIED WITH THE CURRENT DRAWING REVISION.

| | | | | | | | | | | | |
|---------------------------|--|----------------|--|--|--|--|--|-------------------------------|--|---------|--|
| mat'l. code | | | | surface 58 / tolerance ISO 1302 ISO 406 ISO 1101 | | projection  | | product family 58RF | | CODE JP | |
| ltr ecn no dr date | | | | tolerances unless otherwise specified | | mm | | title | | | |
| AA J05-0055 H.T 05-02-04 | | | | angles linear | | mm | | RECOMMENDED CABLE | | | |
| AB J06-0398 H.T 06-09-26 | | | | | | | | (Cat. No. SFW__R-1/2__) | | | |
| AC S08-0276 DGOH 08-08-22 | | | | | | scale X | | dwg no sheet 1 of 1 size | | | |
| | | | | dr H. TAKAKURA 06-09-26 | |  | | JSA 91605 A4 | | | |
| | | | | enr H. TAKAKURA 06-09-26 | | | | type Product Customer Drawing | | | |
| | | | | chr DENNIS GOH 08-08-22 | | | | | | | |
| | | | | appd JOEY NG 08-08-22 | | | | | | | |
| sheet index | | revision sheet | | AC 1 | | | | | | Rev. AC | |

This document is the property of and embodies CONFIDENTIAL and PROPRIETARY information of FCI. No part of the information shown on this document may be used in any way or disclosed to others without the written consent of FCI. Copyright FCI.



FCIconnect.com

RECOMMENDED CABLE (FFC)



n : NO. OF CONDUCTOR



| PT. NO. | PARTS NAME | MATERIAL | NOTE |
|---------|-----------------|------------------------------------|-----------------------------------|
| 1 | INSULATOR | FLAME RESISTING POLYESTER OR EQUAL | _____ |
| 2 | CONDUCTOR | COPPER FOIL | PLATING:TIN OR SOLDER 1um MIN. |
| 3 | SUPPORTING TAPE | FLAME RESISTING POLYESTER OR EQUAL | _____ |

NOTES

1. NO BURR AT EACH PORTION.
2. NO PEELING IN COMMON USE.
3. A  SYMBOL WILL BE NEXT TO ANY DIMENSION, VIEW, OR NOTE WHICH HAS BEEN MODIFIED WITH THE CURRENT DRAWING REVISION.

| | | | | | | | |
|-------------|----------------|------|--|---------------------------------------|--|--|--|
| mat'l. code | | | surface 58 / tolerance ISO 1302 ISO 406 ISO 1101 | | projection  | product family 58RF | CODE JP |
| ltr | ecn no | dr | date | tolerances unless otherwise specified | | title | |
| AA | J05-0055 | H.T | 05-02-04 | angles | linear | RECOMMENDED CABLE (Cat. No. SFW__R-1/2__) | |
| AB | J06-0398 | H.T | 06-09-26 | | | mm | |
| AC | S08-0276 | DGOH | 08-08-22 | | | scale |  |
| | | | dr | H. TAKAKURA | 06-09-26 | dwg no | sheet 1 of 1 |
| | | | enr | H. TAKAKURA | 06-09-26 | JSA 91604 | size  |
| | | | chr | DENNIS GOH | 08-08-22 | type Product Customer Drawing | |
| | | | appd | JOEY NG | 08-08-22 | | |
| sheet index | revision sheet | AC | 1 | | | | Rev. AC |

This document is the property of and embodies CONFIDENTIAL and PROPRIETARY information of FCI. No part of the information shown on this document may be used in any way or disclosed to others without the written consent of FCI. Copyright FCI.



FCIconnect.com





Компания «ЭлектроПласт» предлагает заключение долгосрочных отношений при поставках импортных электронных компонентов на взаимовыгодных условиях!

Наши преимущества:

- Оперативные поставки широкого спектра электронных компонентов отечественного и импортного производства напрямую от производителей и с крупнейших мировых складов;
- Поставка более 17-ти миллионов наименований электронных компонентов;
- Поставка сложных, дефицитных, либо снятых с производства позиций;
- Оперативные сроки поставки под заказ (от 5 рабочих дней);
- Экспресс доставка в любую точку России;
- Техническая поддержка проекта, помощь в подборе аналогов, поставка прототипов;
- Система менеджмента качества сертифицирована по Международному стандарту ISO 9001;
- Лицензия ФСБ на осуществление работ с использованием сведений, составляющих государственную тайну;
- Поставка специализированных компонентов (Xilinx, Altera, Analog Devices, Intersil, Interpoint, Microsemi, Aeroflex, Peregrine, Syfer, Eurofarad, Texas Instrument, Miteq, Cobham, E2V, MA-COM, Hittite, Mini-Circuits, General Dynamics и др.);

Помимо этого, одним из направлений компании «ЭлектроПласт» является направление «Источники питания». Мы предлагаем Вам помощь Конструкторского отдела:

- Подбор оптимального решения, техническое обоснование при выборе компонента;
- Подбор аналогов;
- Консультации по применению компонента;
- Поставка образцов и прототипов;
- Техническая поддержка проекта;
- Защита от снятия компонента с производства.



Как с нами связаться

Телефон: 8 (812) 309 58 32 (многоканальный)

Факс: 8 (812) 320-02-42

Электронная почта: org@eplast1.ru

Адрес: 198099, г. Санкт-Петербург, ул. Калинина, дом 2, корпус 4, литера А.