

# Motor Contactor J7KN

- Range from 4 to 500 kW (AC 3, 380/415 V)
- AC and DC operated
- Integrated auxiliary contacts; integrated aux. contact of J7KN contactors up to 11kW suitable for electronic circuits
- Screw fixing and snap fitting (35 mm DIN rail) up to 37 kW
- Compliant to the global standards
- Finger proof (BGV A2)
- System contactors for Fuseless Load Feeders with integrated link modules
- All needed approvals like CE, UL, GOST & CCC. The J7KN fulfills the following standards; IEC 947-4-1, VDE 0660 and EN 60947-4-1.
- Accessories like auxiliary contacts front or/and side mounted, mechanical interlock and suppressor units.
- Mirror Contacts (NC) according to IEC 60947-4-1 for safety applications



## Model Number Legend

### 1. Motor Contactors

J7KN-□-□-□-□-□ □  
1 2 3 4 5 6

- 1) Motor Contactor
- 2) G for low DC control power consumption
- 3) Rated Motor Current.  
D for integrated aux. contact for electronic circuits (except for 4-pole versions)
- 4) Integrated auxiliary contact configuration
- 5) Coil voltage
- 6) D for DC coil supply

### 2. Aux. Contact Modules for Motor Contactors

J73KN-□-□-□ □  
1 2 3 4

- 1) Auxiliary Contact Modules
- 2) Motor contactors size
- 3) Combination of NO / NC contacts
- 4) Place of mounting

### 3. Accessories for Motor Contactors (Pneumatic Timers)

J74KN-□-□-□-□ □  
1 2 3 4 5

- 1) Accessories for Motor Contactor
- 2) Motor contactors size
- 3) Pneumatic Timer
- 4) Time range
- 5) Function

### 4. Accessories for Motor Contactors (Mechanical Interlock)

J74KN-□-□ □  
1 2 3

- 1) Accessories for Motor Contactor
- 2) Motor contactors size
- 3) Mechanical Interlock

### 5. Accessories for Motor Contactors (RS Suppressor units)

J74KN-□-□-□ □  
1 2 3 4

- 1) Accessories for Motor Contactor
- 2) Motor contactors size
- 3) RS-surge suppressors
- 4) Voltage

### 6. Accessories for Motor Contactors (RC Suppressor units)

J74KN-□-□-□ □  
1 2 3 4

- 1) Accessories for Motor Contactor
- 2) C2 = J7KN
- 3) RC = RC suppressor unit
- 4) Voltage

### 7. Accessories for Motor Contactors (Additional Terminals and Terminal Covers)

J74KN-□-□ □  
1 2







- 1) Accessories for Motor Contactor
- 2) Version



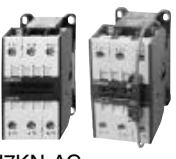

### 8. Insulated wiring systems for Motor Contactors

J74-WK□-□ □  
1 2 3

- 1) Additional reference for LVSG
- 2) WKR = Wiring Kit Reverser;  
WKSD = Wiring Kit Star Delta
- 3) Version

■ Contactors

|  | Ratings  |             |                      |            | Rated current<br>AC1 | No. of Poles | Control circuit<br>Power consum. |         | Aux. Contacts |    |                 |       | Partnumber        |                 |                 |                       |
|--|--|-------------|----------------------|------------|----------------------|--------------|----------------------------------|---------|---------------|----|-----------------|-------|-------------------|-----------------|-----------------|-----------------------|
|  | AC2, AC3   |             |                      |            |                      |              | Inrush                           | Hold    | Built-in      |    | Additional      |       | Type <sup>1</sup> | Add. suffix for |                 |                       |
|  | 380 V<br>400 V<br>415 V<br>kW  | 500 V<br>kW | 660 V<br>690 V<br>kW | 690 V<br>A |                      |              |                                  |         | DC type W     | NO | NC <sup>2</sup> | front |                   |                 | side            | Voltage specification |
| <br>J7KN-AC   | 4  | 5,5         | 5,5                  | 25         | 3                    | 33-45        | 7-10                             | 1       | –             | 4  | –               | –     | J7KN-10D-10 □□□   | –               |                 |                       |
|  |  |             |                      |            | 4                    |              |                                  | –       | 1             |    |                 |       | J7KN-10D-01 □□□   |                 |                 |                       |
|  |  |             |                      |            | 3                    | 3            | 3                                | 1       | –             |    |                 |       | 3                 |                 | J7KN-10D-4 □□□  |                       |
|  |  |             |                      |            | 4                    |              |                                  | –       | 1             |    |                 |       |                   |                 | J7KNG-10-10 □□□ |                       |
|  |  |             |                      |            | 3                    | 75           | 2                                | –       | –             |    |                 |       | 3                 |                 | J7KNG-10-01 □□□ |                       |
|  |  |             |                      |            | 3                    |              |                                  | 1       | –             |    |                 |       |                   |                 | J7KNG-10-4 □□□  |                       |
|  | –  | –           | –                    | 1          | –                    | –            | J7KN-10D-10 □□□                  |         |               |    |                 |       |                   |                 |                 |                       |
|  | –  | –           | –                    | –          | 1                    | –            | J7KN-10D-01 □□□                  |         |               |    |                 |       |                   |                 |                 |                       |
|  | <br>J7KNG     | 5,5         | 7,5                  | 7,5        | 25                   | 3            | 33-45                            | 7-10    | 1             | –  | 4               | –     | –                 | J7KN-14D-10 □□□ | –               |                       |
|  |  |             |                      |            |                      | 4            |                                  |         | –             | 1  |                 |       |                   | J7KN-14D-01 □□□ |                 |                       |
|  |  |             |                      |            |                      | 3            | 3                                | 3       | 1             | –  |                 |       |                   | 3               |                 | J7KN-14D-4 □□□        |
|  |  |             |                      |            |                      | 4            |                                  |         | –             | 1  |                 |       |                   |                 |                 | J7KNG-14-10 □□□       |
| 3  |  |             |                      |            |                      | 75           | 2                                | –       | –             | 3  |                 |       |                   | J7KNG-14-01 □□□ |                 |                       |
| 3  |  |             |                      |            |                      |              |                                  | 1       | –             |    |                 |       |                   | J7KNG-14-4 □□□  |                 |                       |
| –  |  | –           | –                    | 1          | –                    | –            | J7KN-14D-10 □□□                  |         |               |    |                 |       |                   |                 |                 |                       |
| –  |  | –           | –                    | –          | 1                    | –            | J7KN-14D-01 □□□                  |         |               |    |                 |       |                   |                 |                 |                       |
| <br>J7KN-DC |  | 7,5         | 10                   | 10         | 32                   | 3            | 33-45                            | 7-10    | 1             | –  | 4               | –     | –                 | J7KN-18D-10 □□□ | –               |                       |
|  |  |             |                      |            |                      | 4            |                                  |         | –             | 1  |                 |       |                   | J7KN-18D-01 □□□ |                 |                       |
|  |  |             |                      |            |                      | 3            | 3                                | 3       | 1             | –  |                 |       |                   | 3               |                 | J7KN-18D-4 □□□        |
|  |  |             |                      |            |                      | 4            |                                  |         | –             | 1  |                 |       |                   |                 |                 | J7KNG-18-10 □□□       |
|  | 3  |             |                      |            |                      | 75           | 2                                | –       | –             | 3  |                 |       |                   | J7KNG-18-01 □□□ |                 |                       |
|  | 3  |             |                      |            |                      |              |                                  | 1       | –             |    |                 |       |                   | J7KNG-18-4 □□□  |                 |                       |
|  | –  | –           | –                    | 1          | –                    | –            | J7KN-18D-10 □□□                  |         |               |    |                 |       |                   |                 |                 |                       |
|  | –  | –           | –                    | –          | 1                    | –            | J7KN-18D-01 □□□                  |         |               |    |                 |       |                   |                 |                 |                       |
|  | <br>J7KN-22 | 11          | 10                   | 10         | 32                   | 3            | 33-45                            | 7-10    | 1             | –  | 4               | –     | –                 | J7KN-22D-10 □□□ | –               |                       |
|  |  |             |                      |            |                      | 4            |                                  |         | –             | 1  |                 |       |                   | J7KN-22D-01 □□□ |                 |                       |
|  |  |             |                      |            |                      | 3            | 3                                | 3       | 1             | –  |                 |       |                   | 3               |                 | J7KN-22D-4 □□□        |
|  |  |             |                      |            |                      | 4            |                                  |         | –             | 1  |                 |       |                   |                 |                 | J7KNG-22-10 □□□       |
| 3  |  |             |                      |            |                      | 75           | 2                                | –       | –             | 3  |                 |       |                   | J7KNG-22-01 □□□ |                 |                       |
| 3  |  |             |                      |            |                      |              |                                  | 1       | –             |    |                 |       |                   | J7KNG-22-4 □□□  |                 |                       |
| –  |  | –           | –                    | 1          | –                    | –            | J7KN-22D-10 □□□                  |         |               |    |                 |       |                   |                 |                 |                       |
| –  |  | –           | –                    | –          | 1                    | –            | J7KN-22D-01 □□□                  |         |               |    |                 |       |                   |                 |                 |                       |
| <br>J7KN-24 |  | 11          | 15                   | 15         | 50                   | 3            | 90-115                           | 9-13    | –             | –  | 4               | –     | –                 | J7KN-24 □□□     | –               |                       |
|  |  |             |                      |            |                      |              | 4                                | 4       |               |    |                 |       |                   | J7KNG-24 □□□    |                 |                       |
|  |  |             |                      |            |                      |              | 140                              | 2       |               |    |                 |       |                   | J7KN-24 □□□     |                 |                       |
|  |  | 15          | 18,5                 | 18,5       | 65                   | 3            | 3                                | 90-115  | 9-13          | –  | –               | 4     | –                 | –               | J7KN-32 □□□     | –                     |
|  | 4  |             |                      |            |                      |              |                                  | 4       | J7KNG-32 □□□  |    |                 |       |                   |                 |                 |                       |
|  | 140  |             |                      |            |                      |              |                                  | 2       | J7KN-32 □□□   |    |                 |       |                   |                 |                 |                       |
|  | 18,5   | 18,5        | 18,5                 | 80         | 3                    | 3            | 90-115                           | 9-13    | –             | –  | 4               | –     | –                 | J7KN-40 □□□     | –               |                       |
|  |  |             |                      |            |                      |              | 4                                | 4       |               |    |                 |       |                   | J7KNG-40 □□□    |                 |                       |
|  |  |             |                      |            |                      |              | 140                              | 2       |               |    |                 |       |                   | J7KN-40 □□□     |                 |                       |
|  | <br>J7KN-50 | 22          | 30                   | 30         | 110                  | 3            | 140-185                          | 13-18   | –             | –  | 4               | –     | –                 | J7KN-50 □□□     | –               |                       |
|  |  |             |                      |            |                      |              | 200                              | 6       |               |    |                 |       |                   | J7KN-50 □□□     |                 |                       |
|  |  | 30          | 37                   | 37         | 120                  | 3            | 3                                | 140-185 | 13-18         | –  | –               | 4     | –                 | –               | J7KN-62 □□□     | –                     |
| 200  |  |             |                      |            |                      |              |                                  | 6       | J7KN-62 □□□   |    |                 |       |                   |                 |                 |                       |
| 37   |  | 45          | 45                   | 130        | 3                    | 3            | 140-185                          | 13-18   | –             | –  | 4               | –     | –                 | J7KN-74 □□□     | –               |                       |
|  |  |             |                      |            |                      |              | 200                              | 6       |               |    |                 |       |                   | J7KN-74 □□□     |                 |                       |

|   | Ratings                       |     |                         |       | Rated current<br>AC1 | No. of Poles | Control circuit Power consum. |      | Aux. Contacts |                 |            |      | Partnumber         |  |
|---|-------------------------------|-----|-------------------------|-------|----------------------|--------------|-------------------------------|------|---------------|-----------------|------------|------|--------------------|--|
|   | AC2, AC3                      |     | 500 V<br>660 V<br>690 V | 690 V |                      |              | AC type VA<br>DC type W       |      | Built-in      |                 | Additional |      |                    | Type <sup>1</sup><br>Voltage specification<br>24<br>48<br>110<br>230 |
|   | 380 V<br>400 V<br>415 V<br>kW | kW  |                         |       | kW                   | A            | Inrush                        | Hold | NO            | NC <sup>2</sup> | front      | side | Number of contacts |  |
| <br>J7KN-90/115      | 45                            | 55  | 55                      | 160   | 3                    | 190-280 VA   | 2.5-5 VA                      |      |               |                 |            |      |                    | J7KN-90 □□□□ <sup>*3</sup>   |
|   | 55                            | 55  | 55                      | 200   |                      | 280 W        | 5 W                           |      |               | 7               | 4          |      |                    | J7KN-115 □□□□ <sup>*3</sup>  |
| <br>J7KN-151/176     | 75                            | 75  | 75                      | 230   | 3                    | 350          | 5                             | -    | -             | 4               | 2          |      |                    | J7KN-151 □□□□ <sup>*3</sup>  |
|   |                               |     |                         |       | 4                    |              |                               |      |               |                 |            |      |                    | J7KN-151-4 □□□□ <sup>*3</sup>  |
|   | 90                            | 90  | 90                      | 250   | 3                    |              |                               |      |               |                 |            |      |                    | J7KN-176 □□□□ <sup>*3</sup>  |
|   |                               |     |                         |       | 4                    |              |                               |      |               |                 |            |      |                    | J7KN-176-4 □□□□ <sup>*3</sup>  |
| <br>J7KN-210 to 316  | 110                           | 160 | 160                     | 350   | 3                    | 360          | 5                             | -    | -             | 4               | 4          |      |                    | J7KN-210 □□□□ <sup>*3</sup>  |
|   | 132                           | 210 | 210                     | 450   |                      |              |                               |      |               |                 |            |      |                    | J7KN-260 □□□□ <sup>*3</sup>  |
|   | 160                           | 250 | 250                     | 500   |                      |              |                               |      |               |                 |            |      |                    | J7KN-316 □□□□ <sup>*3</sup>  |
| <br>J7KN-450 to 860 | 250                           | 375 | 375                     | 600   | 3                    | 800-950 VA   | 9-11 VA                       | 2    | 2             | 4               | -          |      |                    | J7KN-450-22 □□□□ <sup>*3</sup>                                       |
|   | 300                           | 475 | 475                     | 760   |                      | 750-850 W    | 8-10 W                        |      |               |                 |            |      |                    | J7KN-550-22 □□□□ <sup>*3</sup>                                       |
|   | 400                           | 630 | 630                     | 1000  |                      | 1350-1600 VA | 21-25 VA                      |      |               |                 |            |      |                    | J7KN-700-22 □□□□ <sup>*3</sup>                                       |
|   | 500                           | 700 | 700                     | 1100  |                      | 1300-1550 W  | 18-22 W                       |      |               |                 |            |      |                    | J7KN-860-22 □□□□ <sup>*3</sup>                                       |







<sup>1</sup> For more coil voltages refer to Appendix.

<sup>2</sup> Mirror Contact (NC) according to IEC 60947-4-1 for safety applications

<sup>3</sup> Universal Current models (AC and DC operated)

## Additional products





### Auxiliary Contacts Blocks

|   | Rated Operational Current |              |             | Mounting + comments                        | Contacts  |  | Suitable for Contactors    | Partnumber               |
|---|---------------------------|--------------|-------------|--|---|--|----------------------------|--------------------------|
|   | AC15<br>230V              | AC15<br>400V | AC1<br>690V |  |  |  |                            |                          |
|    | 3                         | 2            | 10          | Front, standard version                    | 1   | –  | J7KN-10D up to<br>J7KN-115 | J73KN-B-10 <sup>2</sup>  |
|   | 3                         | 2            | 10          |  | –   | 1  |                            | J73KN-B-01 <sup>2</sup>  |
|   | 3                         | 2            | 10          | EM/LB version<br>(early make/late break)   | 1   | –  |                            | J73KN-B-10U <sup>2</sup> |
|   | 3                         | 2            | 10          |  | –   | 1  |                            | J73KN-B-01U <sup>2</sup> |
|   | 6                         | 4            | 25          | High current version                       | 1   | –  |                            | J73KN-B-10A <sup>2</sup> |
|   | 6                         | 4            | 25          |  | –   | 1  |                            | J73KN-B-01A <sup>2</sup> |
|    | 3                         | 2            | 10          | Side version, max.<br>2 pcs per contactor  | 1   | 1  | J7KN-24 up to<br>J7KN-115  | J73KN-C-11S <sup>2</sup> |
|    | 3                         | 2            | 10          | Front version, max.<br>1 pcs per contactor | 1   | 1  | J7KN-151 up to<br>J7KN-316 | J73KN-D-11F              |
|   | 3                         | 2            | 10          |  | 2   | 2  |                            | J73KN-D-22F              |
|   | 3                         | 2            | 10          | Side version, max.<br>2 pcs per contactor  | 1   | 1  | J7KN-151 up to<br>J7KN-316 | J73KN-D-11S              |
|  | 3                         | 2            | 10          | Front version, max.<br>1 pcs per contactor | 2   | 2  | J7KN-450 up to<br>J7KN-860 | J73KN-E-22F              |

<sup>1</sup> Mirror Contact (NC) according to IEC 60947-4-1 for safety applications.

<sup>2</sup> Contacts suitable for electronic circuits, according to IEC60947-5-4 for rated voltage 24 VDC (test ratings 17 VDC, 5 mA). Positively guided contacts. Technical data see page 24.

### Pneumatic Timer

|   | Function  | Time range<br>s | Mounting +<br>comments | Contacts  |   |   |   | Suitable for Contactors                        | Partnumber      |
|---|-----------|-----------------|------------------------|---|---|---|---|--|-----------------|
|   |           |                 |                        |  |  |  |  |  |                 |
|  | On-delay  | 0.1 - 40        | Front                  | 1   | 1   | –   | –   | Front for contactors<br>J7KN-10D up to J7KN-40 | J74KN-B-TP40DA  |
|   | On-delay  | 10 - 180        |                        | 1   | 1   | –   | –   |  | J74KN-B-TP180DA |
|   | Off-delay | 0.1 - 40        |                        | –   | –   | 1   | 1   |  | J74KN-B-TP40IA  |
|   | Off-delay | 10 - 180        |                        | –   | –   | 1   | 1   |  | J74KN-B-TP180IA |



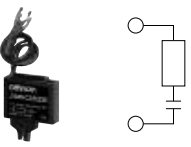

### Mechanical Interlocks

|   | Interlocks contactors with contactors (dimensions need to be the same) | Partnumber                   |             |
|---|--|------------------------------|-------------|
| Type  | Type   | Type                         |             |
|  | J7KN(G)-10(D) - J7KN(G)-40   | + J7KN(G)-10(D) - J7KN(G)-40 | J74KN-B-ML  |
|   | J7KN-24 - J7KN-74  | + J7KN-24 - J7KN-74          | J74KN-C-ML  |
|   | J7KN-90 - J7KN-115   | + J7KN-90 - J7KN-115         | J74KN-D2-ML |
|   | J7KN-151 - J7KN-316  | + J7KN-151 - J7KN-316        | J74KN-E-ML  |



**Suppressor units**

|   | Function                  | For Contactors     | Voltages  |                                  | Partnumber<br>Type  |
|---|---------------------------|--------------------|---|----------------------------------|---|
|  | RC-Unit snap on contactor | J7KN-10D - J7KN-74 | 12 - 48 V<br>48 - 127 V<br>110 - 230 V<br>230 - 415 V | AC/DC<br>AC/DC<br>AC/DC<br>AC/DC | <b>J74KN-C2-RC24</b><br><b>J74KN-C2-RC110</b><br><b>J74KN-C2-RC230</b><br><b>J74KN-C2-RC400</b> |

**Additional products**

|  | Function   | For Contactors                | Specification<br>Cable Cross-section to clamp mm <sup>2</sup> |          |                                      | Partnumber                         |
|--|--|-------------------------------|---|----------|--------------------------------------|------------------------------------|
|  |  |                               | solid or<br>stranded  | flexible | flex. with<br>multicore<br>cable end | Type                               |
|   | Terminals single pole  | J7KN-50 - J7KN-74             | 4 - 35  | 6 - 25   | 4 - 25                               | <b>J74KN-LG-9030</b><br>(3pcs set) |
|   |  | J7KN-151 - J7KN-176           | 16 - 120  | –        | 16 - 95                              | <b>J74KN-LG-11224</b>              |
|   | Terminal cover for terminal protection according DIN 57106, BVG-A2 | J7KN-151 - J7KN-176<br>3-pole | for 3 terminals; 2 units for one contactor                    |          |                                      | <b>J74KN-LG-10404</b>              |
|  |  | J7KN-210 - J7KN-316           |   |          |                                      | <b>J74KN-LG-11457</b>              |
|  | Marking system for contactors and aux. contactblocks               | J7KN-10 to J7KN-74 & J73KN-B  | 2-section without marking, divisible                          |          |                                      | <b>J74KN-P487-1</b>                |
|  |  |                               | 4-section without marking, divisible                          |          |                                      | <b>J74KN-P245-1</b>                |

**Insulated wiring systems for motor contactors**

|   | Function                             | For Contactors      | Specification<br>Maximum current | Partnumber<br>Type |
|---|--------------------------------------|---------------------|----------------------------------|--------------------|
|  | For reversing contactors (2 parts)   | J7KN-10D - J7KN-22D | 22                               | <b>J74-WKR-B2</b>  |
|   |                                      | J7KN-24 - J7KN-40   | 40                               | <b>J74-WKR-C</b>   |
|  | For star-delta combination (4 parts) | J7KN-10D - J7KN-22D | 22                               | <b>J74-WKSD-B2</b> |
|   |                                      | J7KN-24 - J7KN-40   | 40                               | <b>J74-WKSD-C</b>  |

**Wiring Diagrams Coil Circuit / Terminal marking Contactors**

| Range                                   | Supply                     | Wiring coil circuit | Terminal marking |
|---|----------------------------|---------------------|------------------|
| J7KN-10D/14D/18D/22D-10                 | AC                         |                     |                  |
| J7KN-10D/14D/18D/22D-01                 | AC                         |                     |                  |
| J7KNG-10/14/18/22-10                    | DC                         |                     |                  |
| J7KNG-10/14/18/22-01                    | DC                         |                     |                  |
| J7KN-10D/14D/18D/22D-10...D             | DC with double wiring coil |                     |                  |
| J7KN-10D/14D/18D/22D-01...D             | DC with double wiring coil |                     |                  |
| J7KN-10D/14D/18D/22D-4                  | AC                         |                     |                  |
| J7KNG-10/14/18/22-4                     | DC                         |                     |                  |
| J7KN-24/32/40/50/62/74                  | AC                         |                     |                  |
| J7KNG-24/32/40                          | DC                         |                     |                  |
| J7KN-24/32/40/50/62/74D                 | DC with double wiring coil |                     |                  |
| J7KN-90/115/151/176<br>J7KN-210/260/316 | AC/DC                      |                     |                  |
| J7KN- 151/176-4                         | AC/DC                      |                     |                  |
| J7KN- 450/550/700/860                   | AC/DC                      |                     |                  |

**Auxiliary Contacts**

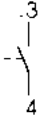
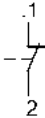
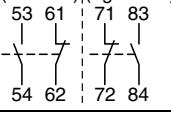
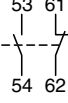
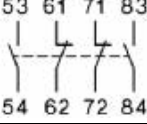
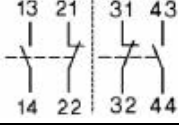
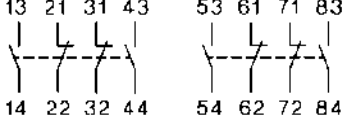
| Range            | Contactors  | Terminal marking  |
|------------------|---|---|
| J73KN-B-10       | J7KN-10D/14D/18D/22D/24/32/40/50/62/74/90/115<br>J7KNG-10/14/18/22/24/32/40 |                              |
| J73KN-B-01 (U/A) | J7KN-24/32/40/50/62/74/90/115<br>J7KNG-24/32/40                             |                              |
| J73KN-C-11S      | J7KN-10D/14D/18D/22D/24/32/40/50/62/74/90/115<br>J7KNG-10/14/18/22/24/32/40 | (left side) (right side)<br> |
| J73KN-D-11F      | J7KN-151 up to J7KN-316   |                              |
| J73KN-D-22F      | J7KN-151 up to J7KN-316   |                              |
| J73KN-D-11S      | J7KN-151 up to J7KN-316   |                             |
| J73KN-E-22F      | J7KN-450 up to J7KN-860   |                            |

**Pneumatic timer**

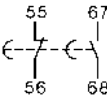
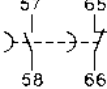
| Range                        | Contactors  | Terminal marking  |
|------------------------------|---|---|
| J73KN-B-TP...DA<br>ON-delay  | J7KN-10D/14D/18D/22D/24/32/40<br>J7KNG-10/14/18/22/24/32/40 |  |
| J73KN-B-TP...IA<br>OFF-delay | J7KN-10D/14D/18D/22D/24/32/40<br>J7KNG-10/14/18/22/24/32/40 |  |

**Coil voltage**

**Type-suffix for Contactors**

| Contactor range     | Suffix | Marking at coil |           | Rated Control Voltage $U_s$ |       |               |       |
|---------------------|--------|-----------------|-----------|-----------------------------|-------|---------------|-------|
|                     |        | 50Hz<br>V       | 60Hz<br>V | 50Hz<br>min V               | max V | 60Hz<br>min V | max V |
| J7KN-10D to J7KN-74 | 24     | 24              | 24        | 22                          | 24    | 24            | 27    |
|                     | 48     | 48              | 48        | 44                          | 48    | 48            | 52    |
|                     | 110    | 110             | 110-120   | 100                         | 110   | 110           | 122   |
|                     | 180    | 180-210         | 200-240   | 180                         | 210   | 200           | 240   |
|                     | 230    | 220-240         | 230-264   | 220                         | 240   | 230           | 264   |
|                     | 400    | 380-415         | 400-440   | 380                         | 415   | 400           | 460   |
| J7KN-90 to J7KN-860 | 500    | 500-550         | 550-600   | 500                         | 550   | 550           | 600   |
|                     | 24     | 24              | 24        | 24                          | 24    | 24            | 24    |
|                     | 48     | 48              | 48        | 48                          | 48    | 48            | 48    |
|                     | 110    | 110-120         | 110-120   | 110                         | 120   | 110           | 120   |
|                     | 230    | 220-240         | 220-240   | 220                         | 240   | 220           | 240   |
|                     | 400    | 380-415         | 380-415   | 380                         | 415   | 380           | 415   |

Operating range of magnet-coils:

AC:  $0.85 \times U_s$  (min. value of rated control voltage) up to  $1.1 \times U_s$  (max. value of rated control voltage).

DC:  $0.8 \times U_s$  (min. value of rated control voltage) up to  $1.1 \times U_s$  (max. value of rated control voltage).

## ■ Engineering data and characteristics

### Approximate Values for three-phase Motors

#### Motor Full Load Currents

Approximate values of motor F.L.C. and minimum „slow blow“ respectively „gL“ short-circuit fuse

| Motor rating<br>Range according to BS for 415V |       |     |      |    | 220-230V Motor<br>Value of fusing at motor start |             |         | 240V Motor<br>Value of fusing at motor start |             |         | 380-400V Motor<br>Value of fusing at motor start |             |         | 415V Motor<br>Value of fusing at motor start |             |         | 500V Motor<br>Value of fusing at motor start |             |         | 660-690V Motor<br>Value of fusing at motor start |             |         |
|--|-------|-----|------|----|--|-------------|---------|--|-------------|---------|--|-------------|---------|--|-------------|---------|--|-------------|---------|--|-------------|---------|
| kW   | PS-hp | hp  | cos  | %  | F.L.C.<br>A                                      | D.O.L.<br>A | YD<br>A | F.L.C.<br>A                                  | D.O.L.<br>A | YD<br>A | F.L.C.<br>A                                      | D.O.L.<br>A | YD<br>A | F.L.C.<br>A                                  | D.O.L.<br>A | YD<br>A | F.L.C.<br>A                                  | D.O.L.<br>A | YD<br>A | F.L.C.<br>A                                      | D.O.L.<br>A | YD<br>A |
| 0.06   | 0.08  | -   | 0.7  | 59 | 0.38   | 1           | 1       | 0.35   | 1           | 1       | 0.22   | 1           | 1       | -  | -           | -       | 0.16   | 1           | 1       | -  | -           | -       |
| 0.09   | 0.12  | -   | 0.7  | 60 | 0.55   | 2           | 2       | 0.5  | 2           | 2       | 0.33   | 1           | 1       | -  | -           | -       | 0.24   | 1           | 1       | -  | -           | -       |
| 0.12   | 0.16  | -   | 0.7  | 61 | 0.76   | 2           | 2       | 0.68   | 2           | 2       | 0.42   | 2           | 2       | -  | -           | -       | 0.33   | 1           | 1       | -  | -           | -       |
| 0.18   | 0.24  | -   | 0.7  | 61 | 1.1  | 2           | 2       | 1  | 2           | 2       | 0.64   | 2           | 2       | -  | -           | -       | 0.46   | 1           | 1       | -  | -           | -       |
| 0.25   | 0.34  | -   | 0.7  | 62 | 1.4  | 4           | 2       | 1.38   | 4           | 2       | 0.88   | 2           | 2       | -  | -           | -       | 0.59   | 2           | 2       | -  | -           | -       |
| 0.37   | 0.5   | -   | 0.72 | 64 | 2.1  | 4           | 4       | 1.93   | 4           | 4       | 1.22   | 4           | 2       | -  | -           | -       | 0.85   | 2           | 2       | 0.7  | 2           | 2       |
| 0.55   | 0.75  | -   | 0.75 | 69 | 2.7  | 4           | 4       | 2.3  | 4           | 4       | 1.5  | 4           | 2       | -  | -           | -       | 1.2  | 4           | 2       | 0.9  | 2           | 2       |
| 0.75   | 1     | 1   | 0.8  | 74 | 3.3  | 6           | 4       | 3.1  | 6           | 4       | 2  | 4           | 4       | 2  | 4           | 4       | 1.48   | 4           | 2       | 1.1  | 2           | 2       |
| 1.1  | 1.5   | 1.5 | 0.83 | 77 | 4.9  | 10          | 6       | 4.1  | 6           | 6       | 2.6  | 4           | 4       | 2.5  | 4           | 4       | 2.1  | 4           | 4       | 1.5  | 4           | 2       |
| 1.5  | 2     | 2   | 0.83 | 78 | 6.2  | 10          | 10      | 5.6  | 10          | 10      | 3.5  | 6           | 4       | 3.5  | 6           | 4       | 2.6  | 4           | 4       | 2  | 4           | 4       |
| 2.2  | 3     | 3   | 0.83 | 81 | 8.7  | 16          | 10      | 7.9  | 16          | 10      | 5  | 10          | 6       | 5  | 10          | 6       | 3.8  | 6           | 6       | 2.9  | 6           | 4       |
| 2.5  | 3.4   | -   | 0.83 | 81 | 9.8  | 16          | 16      | 8.9  | 16          | 10      | 5.7  | 10          | 10      | -  | -           | -       | 4.3  | 6           | 6       | -  | -           | -       |
| 3  | 4     | 4   | 0.84 | 81 | 11.6   | 20          | 16      | 10.6   | 20          | 16      | 6.6  | 16          | 10      | 6.5  | 16          | 10      | 5.1  | 10          | 10      | 3.5  | 6           | 4       |
| 3.7  | 5     | 5   | 0.84 | 82 | 14.2   | 25          | 20      | 13   | 25          | 16      | 8.2  | 16          | 10      | 7.5  | 16          | 10      | 6.2  | 16          | 10      | -  | -           | -       |
| 4  | 5.5   | -   | 0.84 | 82 | 15.3   | 25          | 20      | 14   | 25          | 20      | 8.5  | 16          | 10      | -  | -           | -       | 6.5  | 16          | 10      | 4.9  | 10          | 6       |
| 5.5  | 7.5   | 7.5 | 0.85 | 83 | 20.6   | 35          | 25      | 18.9   | 35          | 25      | 11.5   | 20          | 16      | 11   | 20          | 16      | 8.9  | 16          | 10      | 6.7  | 16          | 10      |
| 7.5  | 10    | 10  | 0.86 | 85 | 27.4   | 35          | 35      | 24.8   | 35          | 35      | 15.5   | 25          | 20      | 14   | 25          | 16      | 11.9   | 20          | 16      | 9  | 16          | 10      |
| 8  | 11    | -   | 0.86 | 85 | 28.8   | 50          | 35      | 26.4   | 35          | 35      | 16.7   | 25          | 20      | -  | -           | -       | 12.7   | 20          | 16      | -  | -           | -       |
| 11   | 15    | 15  | 0.86 | 87 | 39.2   | 63          | 50      | 35.3   | 50          | 50      | 22   | 35          | 25      | 21   | 35          | 25      | 16.7   | 25          | 20      | 13   | 25          | 16      |
| 12.5   | 17    | -   | 0.86 | 87 | 43.8   | 63          | 50      | 40.2   | 63          | 50      | 25   | 35          | 35      | -  | -           | -       | 19   | 35          | 25      | -  | -           | -       |
| 15   | 20    | 20  | 0.86 | 87 | 52.6   | 80          | 63      | 48.2   | 80          | 63      | 30   | 50          | 35      | 28   | 35          | 35      | 22.5   | 35          | 25      | 17.5   | 25          | 20      |
| 18.5   | 25    | 25  | 0.86 | 88 | 64.9   | 100         | 80      | 58.7   | 80          | 63      | 37   | 63          | 50      | 35   | 50          | 50      | 28.5   | 50          | 35      | 21   | 35          | 25      |
| 20   | 27    | -   | 0.86 | 88 | 69.3   | 100         | 80      | 63.4   | 80          | 80      | 40   | 63          | 50      | -  | -           | -       | 30.6   | 50          | 35      | -  | -           | -       |
| 22   | 30    | 30  | 0.87 | 89 | 75.2   | 100         | 80      | 68   | 100         | 80      | 44   | 63          | 50      | 40   | 63          | 50      | 33   | 50          | 50      | 25   | 35          | 35      |
| 25   | 34    | -   | 0.87 | 89 | 84.4   | 125         | 100     | 77.2   | 100         | 100     | 50   | 80          | 63      | -  | -           | -       | 38   | 63          | 50      | -  | -           | -       |
| 30   | 40    | 40  | 0.87 | 90 | 101  | 125         | 125     | 92.7   | 125         | 100     | 60   | 80          | 63      | 55   | 80          | 63      | 44   | 63          | 50      | 33   | 50          | 35      |
| 37   | 50    | 50  | 0.87 | 90 | 124  | 160         | 160     | 114  | 160         | 125     | 72   | 100         | 80      | 66   | 100         | 80      | 54   | 80          | 63      | 42   | 63          | 50      |
| 40   | 54    | -   | 0.87 | 90 | 134  | 160         | 160     | 123  | 160         | 160     | 79   | 100         | 100     | -  | -           | -       | 60   | 80          | 63      | -  | -           | -       |
| 45   | 60    | 60  | 0.88 | 91 | 150  | 200         | 160     | 136  | 200         | 160     | 85   | 125         | 100     | 80   | 100         | 100     | 64.5   | 100         | 80      | 49   | 63          | 63      |
| 51   | 70    | -   | 0.88 | 91 | 168  | 200         | 200     | 154  | 200         | 200     | 97   | 125         | 100     | -  | -           | -       | 73.7   | 100         | 80      | -  | -           | -       |
| 55   | 75    | -   | 0.88 | 91 | 181  | 250         | 200     | 166  | 200         | 200     | 105  | 160         | 125     | -  | -           | -       | 79   | 125         | 100     | 60   | 80          | 63      |
| 59   | 80    | 80  | 0.88 | 91 | 194  | 250         | 250     | 178  | 250         | 200     | 112  | 160         | 125     | 105  | 160         | 125     | 85.3   | 125         | 100     | -  | -           | -       |
| 75   | 100   | 100 | 0.88 | 91 | 245  | 315         | 250     | 226  | 315         | 250     | 140  | 200         | 160     | 135  | 200         | 160     | 106  | 160         | 125     | 82   | 125         | 100     |
| 90   | 125   | 125 | 0.88 | 92 | 292  | 400         | 315     | 268  | 315         | 315     | 170  | 250         | 200     | 165  | 200         | 200     | 128  | 160         | 160     | 98   | 125         | 125     |
| 110  | 150   | 150 | 0.88 | 92 | 358  | 500         | 400     | 327  | 400         | 400     | 205  | 250         | 250     | 200  | 250         | 250     | 156  | 200         | 200     | 118  | 160         | 125     |
| 129  | 175   | 175 | 0.88 | 92 | 420  | 500         | 500     | 384  | 500         | 400     | 242  | 315         | 250     | 230  | 315         | 250     | 184  | 250         | 200     | -  | -           | -       |
| 132  | 180   | -   | 0.88 | 92 | 425  | 500         | 500     | 393  | 500         | 500     | 245  | 315         | 250     | -  | -           | -       | 186  | 250         | 200     | 140  | 200         | 160     |
| 147  | 200   | 200 | 0.88 | 93 | 472  | 630         | 630     | 432  | 630         | 500     | 273  | 315         | 315     | 260  | 315         | 315     | 207  | 250         | 250     | -  | -           | -       |
| 160  | 220   | -   | 0.88 | 93 | 502  | 630         | 630     | 471  | 630         | 630     | 295  | 400         | 315     | -  | -           | -       | 220  | 315         | 250     | 170  | 200         | 200     |
| 184  | 250   | 250 | 0.88 | 93 | 590  | 800         | 630     | 541  | 630         | 630     | 340  | 400         | 400     | 325  | 400         | 400     | 259  | 315         | 315     | -  | -           | -       |
| 200  | 270   | -   | 0.88 | 93 | 626  | 800         | 800     | 589  | 800         | 630     | 370  | 500         | 400     | -  | -           | -       | 278  | 315         | 315     | 215  | 250         | 250     |
| 220  | 300   | 300 | 0.88 | 93 | 700  | 1000        | 800     | 647  | 800         | 800     | 408  | 500         | 500     | 385  | 500         | 400     | 310  | 400         | 400     | -  | -           | -       |
| 250  | 340   | -   | 0.88 | 93 | 803  | 1000        | 1000    | 736  | 1000        | 800     | 460  | 630         | 500     | -  | -           | -       | 353  | 500         | 400     | 268  | 315         | 315     |
| 257  | 350   | 350 | 0.88 | 93 | 826  | 1000        | 1000    | 756  | 1000        | 800     | 475  | 630         | 630     | 450  | 630         | 500     | 363  | 500         | 400     | -  | -           | -       |
| 295  | 400   | 400 | 0.88 | 93 | 948  | 1250        | 1000    | 868  | 1000        | 1000    | 546  | 800         | 630     | 500  | 630         | 630     | 416  | 500         | 500     | -  | -           | -       |
| 315  | 430   | -   | 0.88 | 93 | 990  | 1250        | 1250    | 927  | 1250        | 1000    | 580  | 800         | 630     | -  | -           | -       | 445  | 630         | 500     | 337  | 400         | 400     |
| 355  | 483   | -   | 0.89 | 95 | -  | -           | -       | -  | -           | -       | 636  | 800         | 800     | -  | -           | -       | 483  | 630         | 630     | 366  | 500         | 400     |
| 400  | 545   | -   | 0.89 | 96 | -  | -           | -       | -  | -           | -       | 710  | 1000        | 800     | -  | -           | -       | 538  | 630         | 630     | 410  | 500         | 500     |

The motor F.L.C. be valid for standard internal and surface cooled three-pole motors with 1500 min<sup>-1</sup>. The fuses values be valid for the motor F.L.C. shown in the table and D.O.L.-start: starting current max. 6x motor F.L.C., starting time max. 5s; star-delta-start: starting current max. 2x motor F.L.C., starting time max. 15s. For motors with higher F.L.C., higher starting current and / or longer starting time, larger short-circuit fuses are required.

The maximum admissible value is dependent on the switchgear respectively thermal overload relay.



Approximate values of motor F.L.C. according to CSA and UL

| Motor rating<br>hp | Motor F.L.C. at 110-120V |              |              | Motor F.L.C. at 220-240V <sup>*1</sup> |              |              | Motor F.L.C. at 440-480V |              |              | Motor F.L.C. at 550-600V |              |              |
|--------------------|--------------------------|--------------|--------------|--|--------------|--------------|--------------------------|--------------|--------------|--------------------------|--------------|--------------|
|                    | 1-phase<br>A             | 2-phase<br>A | 3-phase<br>A | 1-phase<br>A                           | 2-phase<br>A | 3-phase<br>A | 1-phase<br>A             | 2-phase<br>A | 3-phase<br>A | 1-phase<br>A             | 2-phase<br>A | 3-phase<br>A |
| 1/2                | 9.8                      | 4.0          | 4.4          | 4.9                                    | 2.0          | 2.2          | 2.5                      | 1.0          | 1.1          | 2.0                      | 0.8          | 0.9          |
| 3/4                | 13.8                     | 4.8          | 6.4          | 6.9                                    | 2.4          | 3.2          | 3.5                      | 1.2          | 1.6          | 2.8                      | 1.0          | 1.3          |
| 1                  | 16.0                     | 6.4          | 8.4          | 8.0                                    | 3.2          | 4.2          | 4.0                      | 1.6          | 2.1          | 3.2                      | 1.3          | 1.7          |
| 1 1/2              | 20.0                     | 9.0          | 12.0         | 10.0                                   | 4.5          | 6.0          | 5.0                      | 2.3          | 3.0          | 4.0                      | 1.8          | 2.4          |
| 2                  | 24.0                     | 11.8         | 13.6         | 12.0                                   | 5.9          | 6.8          | 6.0                      | 3.0          | 3.4          | 4.8                      | 2.4          | 2.7          |
| 3                  | 34.0                     | 16.6         | 19.2         | 17.0                                   | 8.3          | 9.6          | 8.5                      | 4.2          | 4.8          | 6.8                      | 3.3          | 3.9          |
| 5                  | 56.0                     | 26.4         | 30.4         | 28.0                                   | 13.2         | 15.2         | 14.0                     | 6.6          | 7.6          | 11.2                     | 5.3          | 6.1          |
| 7 1/2              | 80.0                     | 38.0         | 44.0         | 40.0                                   | 19.0         | 22.0         | 21.0                     | 9.0          | 11.0         | 16.0                     | 8.0          | 9.0          |
| 10                 | 100.0                    | 48.0         | 56.0         | 50.0                                   | 24.0         | 28.0         | 26.0                     | 12.0         | 14.0         | 20.0                     | 10.0         | 11.0         |
| 15                 | 135.0                    | 72.0         | 84.0         | 68.0                                   | 36.0         | 42.0         | 34.0                     | 18.0         | 21.0         | 27.0                     | 14.0         | 17.0         |
| 20                 | -                        | 94.0         | 108.0        | 88.0                                   | 47.0         | 54.0         | 44.0                     | 23.0         | 27.0         | 35.0                     | 19.0         | 22.0         |
| 25                 | -                        | 118.0        | 136.0        | 110.0                                  | 59.0         | 68.0         | 55.0                     | 29.0         | 34.0         | 44.0                     | 24.0         | 27.0         |
| 30                 | -                        | 138.0        | 160.0        | 136.0                                  | 69.0         | 80.0         | 68.0                     | 35.0         | 40.0         | 54.0                     | 28.0         | 32.0         |
| 40                 | -                        | 180.0        | 208.0        | 176.0                                  | 90.0         | 104.0        | 88.0                     | 45.0         | 52.0         | 70.0                     | 36.0         | 41.0         |
| 50                 | -                        | 226.0        | 260.0        | 216.0                                  | 113.0        | 130.0        | 108.0                    | 56.0         | 65.0         | 86.0                     | 45.0         | 52.0         |
| 60                 | -                        | -            | -            | -                                      | 133.0        | 145.0        | -                        | 67.0         | 77.0         | -                        | 53.0         | 62.0         |
| 75                 | -                        | -            | -            | -                                      | 166.0        | 192.0        | -                        | 83.0         | 96.0         | -                        | 66.0         | 77.0         |
| 100                | -                        | -            | -            | -                                      | 218.0        | 248.0        | -                        | 109.0        | 124.0        | -                        | 87.0         | 99.0         |
| 125                | -                        | -            | -            | -                                      | -            | 312.0        | -                        | 135.0        | 156.0        | -                        | 108.0        | 125.0        |
| 150                | -                        | -            | -            | -                                      | -            | 360.0        | -                        | 156.0        | 180.0        | -                        | 125.0        | 144.0        |
| 200                | -                        | -            | -            | -                                      | -            | 480.0        | -                        | 208.0        | 240.0        | -                        | 167.0        | 192.0        |
| 250                | -                        | -            | -            | -                                      | -            | 602.0        | -                        | -            | 302.0        | -                        | -            | 242.0        |
| 300                | -                        | -            | -            | -                                      | -            | -            | -                        | -            | 361.0        | -                        | -            | 289.0        |
| 350                | -                        | -            | -            | -                                      | -            | -            | -                        | -            | 414.0        | -                        | -            | 336.0        |
| 400                | -                        | -            | -            | -                                      | -            | -            | -                        | -            | 477.0        | -                        | -            | 382.0        |
| 500                | -                        | -            | -            | -                                      | -            | -            | -                        | -            | 590.0        | -                        | -            | 472.0        |

\*1 Determine the motor current for 200V and 208V by increasing the values for 220-240V at 200V about 15% and for 208V about 10%.

**Contactors**

**Data according to IEC 60947-4-1, EN 60947-4-1, VDE 0660**

| Main Contacts   | Type                    | J7KN(G)-10(D) | J7KN(G)-14(D) | J7KN(G)-18(D) | J7KN(G)-22(D) | J7KN(G)-24 | J7KN(G)-32 | J7KN(G)-40  | J7KN-50    |
|---|-------------------------|---------------|---------------|---------------|---------------|------------|------------|-------------|------------|
| Rated insulation voltage $U_i^{*1}$                             | V AC                    | 690           | 690           | 690           | 690           | 690        | 690        | 690         | 690        |
| Making capacity $I_{eff}$                                       | at $U_e = A$<br>690V AC | 200           | 200           | 200           | 200           | 400        | 500        | 500         | 700        |
| Breaking capacity $I_{eff}$                                     | 400V AC A               | 180           | 180           | 200           | 200           | 380        | 400        | 400         | 600        |
| J7KN-09 to J7KN-22  | 500V AC A               | 150           | 150           | 180           | 180           | 300        | 370        | 370         | 500        |
| J7KN-24 to J7KN-860   | 690V AC A               | 100           | 100           | 150           | 150           | 260        | 340        | 340         | 400        |
|   | 1000V AC A              | –             | –             | –             | –             | –          | –          | –           | –          |
| <b>Utilization category AC1</b>                                 |                         |               |               |               |               |            |            |             |            |
| <b>Switching of resistive load</b>                              |                         |               |               |               |               |            |            |             |            |
| Rated operational current $I_e (=I_{th})$ at 40°C, open         | 690V A                  | <b>25</b>     | <b>25</b>     | <b>32</b>     | <b>32</b>     | <b>50</b>  | <b>65</b>  | <b>80</b>   | <b>110</b> |
| Rated operational power of three-phase resistive loads          | 220V kW                 | 9,5           | 9,5           | 12,2          | 12,2          | 19,0       | 24,7       | 30,4        | 41,9       |
|   | 230V kW                 | 9,9           | 9,9           | 12,7          | 12,7          | 19,9       | 25,9       | 31,8        | 43,8       |
|   | 240V kW                 | 10,4          | 10,4          | 13,3          | 13,3          | 20,8       | 27,0       | 33,2        | 45,7       |
|   | 380V kW                 | 16,4          | 16,4          | 21,0          | 21,0          | 32,9       | 42,7       | 52,6        | 72,3       |
|   | 400V kW                 | 17,3          | 17,3          | 22,1          | 22,1          | 34,6       | 45,0       | 55,4        | 76,1       |
|   | 415V kW                 | 17,9          | 17,9          | 23,0          | 23,0          | 35,9       | 46,7       | 57,4        | 79,0       |
|   | 440V kW                 | 19,0          | 19,0          | 24,4          | 24,4          | 38,1       | 49,5       | 60,9        | 83,7       |
|   | 500V kW                 | 21,6          | 21,6          | 27,7          | 27,7          | 43,3       | 56,2       | 69,2        | 95,2       |
|   | 660V kW                 | 28,5          | 28,5          | 36,5          | 36,5          | 57,1       | 74,2       | 91,3        | 125,6      |
|   | 690V kW                 | 29,8          | 29,8          | 38,2          | 38,2          | 59,7       | 77,6       | 95,5        | 131,3      |
|   | 1000V kW                | –             | –             | –             | –             | –          | –          | –           | –          |
| Rated operational current $I_e (=I_{the})$ at 60°C, enclosed    | 690V A                  | 25            | 25            | 32            | 32            | 40         | 55         | 65          | 90         |
| Rated operational power of three-phase resistive loads          | 220V kW                 | 9,5           | 9,5           | 12,2          | 12,2          | 15,2       | 20,9       | 24,7        | 34,3       |
|   | 230V kW                 | 9,9           | 9,9           | 12,7          | 12,7          | 15,9       | 21,9       | 25,9        | 35,8       |
|   | 240V kW                 | 10,4          | 10,4          | 13,3          | 13,3          | 16,6       | 22,8       | 27,0        | 37,4       |
|   | 380V kW                 | 16,4          | 16,4          | 21,0          | 21,0          | 26,3       | 36,2       | 42,7        | 59,2       |
|   | 400V kW                 | 17,3          | 17,3          | 22,1          | 22,1          | 27,7       | 38,1       | 45,0        | 62,3       |
|   | 415V kW                 | 17,9          | 17,9          | 23,0          | 23,0          | 28,7       | 39,5       | 46,7        | 64,6       |
|   | 440V kW                 | 19,0          | 19,0          | 24,4          | 24,4          | 30,4       | 41,9       | 49,5        | 68,5       |
|   | 500V kW                 | 21,6          | 21,6          | 27,7          | 27,7          | 34,6       | 47,6       | 56,2        | 77,9       |
|   | 660V kW                 | 28,5          | 28,5          | 36,5          | 36,5          | 45,7       | 62,8       | 74,2        | 102,8      |
|   | 690V kW                 | 29,8          | 29,8          | 38,2          | 38,2          | 47,7       | 65,7       | 77,6        | 107,4      |
|   | 1000V kW                | –             | –             | –             | –             | –          | –          | –           | –          |
| Minimum cross-section of conductor at load with $I_e (=I_{th})$ | mm <sup>2</sup>         | 4             | 4             | 6             | 6             | 10         | 16         | 25          | 35         |
| <b>Utilization category AC2 and AC3</b>                         |                         |               |               |               |               |            |            |             |            |
| <b>Switching of three-phase motors</b>                          |                         |               |               |               |               |            |            |             |            |
| Rated operational current $I_e$ open and enclosed               | 220V A                  | 12            | 15            | 18            | 22            | 24         | 30         | 40          | 50         |
|   | 230V A                  | 11,5          | 14,5          | 18            | 22            | 24         | 30         | 40          | 50         |
|   | 240V A                  | 11            | 14            | 18            | 22            | 24         | 32         | 40          | 50         |
|   | <b>380-400V A</b>       | <b>10</b>     | <b>14</b>     | <b>18</b>     | <b>22</b>     | <b>24</b>  | <b>32</b>  | <b>40</b>   | <b>50</b>  |
|   | 415V A                  | 9             | 14            | 18            | 22            | 23         | 30         | 40          | 50         |
|   | 440V A                  | 9             | 14            | 18            | 22            | 23         | 30         | 40          | 50         |
|   | 500V A                  | 7             | 9             | 9             | 9             | 17,5       | 21         | 21          | 33         |
|   | 660-690V A              | 6,5           | 8,5           | 8,5           | 8,5           | 17         | 20         | 20          | 31         |
|   | 1000V A                 | –             | –             | –             | –             | –          | –          | –           | –          |
| Rated operational power of three-phase motors                   | 220-230V kW             | 3             | 4             | 5             | 6             | 6          | 8,5        | 11          | 12,5       |
|   | 240V kW                 | 3             | 4             | 5             | 7             | 7          | 9          | 11,5        | 13,5       |
|   | <b>380-400V kW</b>      | <b>4</b>      | <b>5,5</b>    | <b>7,5</b>    | <b>11</b>     | <b>11</b>  | <b>15</b>  | <b>18,5</b> | <b>22</b>  |
|   | 415V kW                 | 4,5           | 6             | 8,5           | 12            | 12         | 16         | 20          | 24         |
|   | 440V kW                 | 4,5           | 6             | 8,5           | 12            | 12         | 16         | 20          | 24         |
|   | 500V kW                 | 5,5           | 7,5           | 10            | 10            | 15         | 18,5       | 18,5        | 30         |
|   | 660-690V kW             | 5,5           | 7,5           | 10            | 10            | 15         | 18,5       | 18,5        | 30         |
|   | 1000V kW                | –             | –             | –             | –             | –          | –          | –           | –          |

\*1 Suitable at 690V for: earthed-neutral systems, overvoltage I to IV, pollution degree 3 (standard-industry):  $U_{imp} = 8kV$ .  
Data for other conditions on request.

**Contactors**

Data according to IEC 60947-4-1, EN 60947-4-1, VDE 0660

| Type            | J7KN-62    | J7KN-74    | J7KN-90    | J7KN-115   | J7KN-151   | J7KN-176   | J7KN-210   | J7KN-260   | J7KN-316   | J7KN-450   | J7KN-550   | J7KN-700    | J7KN-860    |
|-----------------|------------|------------|------------|------------|------------|------------|------------|------------|------------|------------|------------|-------------|-------------|
| V~              | 690        | 690        | 1000       | 1000       | 1000       | 1000       | 1000       | 1000       | 1000       | 1000       | 1000       | 690         | 690         |
| A               | 900        | 900        | 1100       | 1200       | 1500       | 2000       | 2100       | 2600       | 3200       | 4500       | 5500       | 7000        | 8600        |
| A               | 800        | 800        | 950        | 1100       | 1200       | 1500       | 1600       | 2100       | 2600       | 4500       | 5500       | 7000        | 8000        |
| A               | 700        | 700        | 850        | 1000       | 1200       | 1500       | 1600       | 2100       | 2600       | 4500       | 5500       | 7000        | 8000        |
| A               | 500        | 500        | 600        | 600        | 1000       | 800        | 1200       | 1900       | 2300       | 3200       | 4400       | 5600        | 6900        |
| A               | –          | –          | –          | –          | 500        | 600        | 700        | 850        | 1000       | –          | –          | –           | –           |
| <b>A</b>        | <b>120</b> | <b>130</b> | <b>160</b> | <b>200</b> | <b>230</b> | <b>250</b> | <b>350</b> | <b>450</b> | <b>500</b> | <b>700</b> | <b>760</b> | <b>1000</b> | <b>1100</b> |
| kW              | 45,7       | 49,5       | 60         | 76         | 87         | 95         | 133        | 171        | 190        | 266        | 289        | 381         | 419         |
| kW              | 47,7       | 51,7       | 63         | 79         | 91         | 99         | 139        | 179        | 199        | 279        | 302        | 398         | 438         |
| kW              | 49,8       | 54,0       | 66         | 83         | 95         | 103        | 145        | 187        | 207        | 291        | 315        | 415         | 457         |
| kW              | 78,9       | 85,5       | 105        | 131        | 151        | 164        | 230        | 296        | 329        | 460        | 500        | 658         | 724         |
| kW              | 83,0       | 90,0       | 110        | 138        | 159        | 173        | 242        | 311        | 346        | 485        | 426        | 692         | 762         |
| kW              | 86,2       | 93,3       | 115        | 143        | 165        | 179        | 251        | 323        | 359        | 503        | 546        | 718         | 790         |
| kW              | 91,3       | 99,0       | 121        | 152        | 175        | 190        | 266        | 342        | 381        | 533        | 579        | 762         | 838         |
| kW              | 103,8      | 112,5      | 138        | 173        | 199        | 216        | 303        | 389        | 453        | 606        | 658        | 866         | 952         |
| kW              | 137,0      | 148,4      | 182        | 228        | 262        | 285        | 400        | 514        | 571        | 800        | 868        | 1143        | 1257        |
| kW              | 143,2      | 155,2      | 191        | 239        | 274        | 298        | 418        | 537        | 597        | 836        | 908        | 1195        | 1314        |
| kW              | –          | –          | 221        | 277        | 318        | 346        | 433        | 546        | 606        | 692        | 866        | –           | –           |
| A               | 100        | 110        | 120        | 135        | 180        | 200        | 280        | 360        | 400        | 550        | 600        | 800         | 875         |
| kW              | 38,1       | 41,9       | 45         | 51         | 68         | 76         | 106        | 137        | 152        | 209        | 228        | 304         | 333         |
| kW              | 39,8       | 43,8       | 47         | 53         | 71         | 79         | 111        | 143        | 159        | 219        | 239        | 318         | 348         |
| kW              | 41,5       | 45,7       | 49         | 56         | 74         | 83         | 116        | 150        | 166        | 228        | 249        | 332         | 363         |
| kW              | 65,7       | 72,3       | 78         | 88         | 118        | 131        | 184        | 237        | 263        | 362        | 395        | 526         | 575         |
| kW              | 69,2       | 76,1       | 83         | 93         | 124        | 138        | 193        | 249        | 277        | 381        | 415        | 554         | 606         |
| kW              | 71,8       | 79,0       | 86         | 97         | 129        | 143        | 201        | 259        | 287        | 395        | 431        | 575         | 628         |
| kW              | 76,1       | 83,7       | 91         | 102        | 137        | 152        | 213        | 274        | 304        | 419        | 457        | 609         | 666         |
| kW              | 86,5       | 95,2       | 103        | 116        | 155        | 173        | 242        | 312        | 346        | 476        | 519        | 692         | 757         |
| kW              | 114,2      | 125,6      | 137        | 154        | 205        | 228        | 320        | 412        | 457        | 628        | 685        | 914         | 1000        |
| kW              | 119,4      | 131,3      | 143        | 161        | 215        | 239        | 334        | 430        | 478        | 657        | 717        | 956         | 1045        |
| kW              | –          | –          | 166        | 187        | 277        | 346        | 388        | 499        | 554        | 692        | 866        | –           | –           |
| mm <sup>2</sup> | 50         | 50         | 70         | 95         | 95         | 120        | 240        | 2x150      | 2x(30x6)   | 2x(40x5)   | 2x(50x5)   | 2x(60x5)    | 2x(60x6)    |
| A               | 63         | 74         | 90         | 115        | 150        | 175        | 210        | 260        | 315        | 450        | 550        | 700         | 860         |
| A               | 62         | 74         | 90         | 115        | 150        | 175        | 210        | 260        | 315        | 450        | 550        | 700         | 860         |
| A               | 62         | 74         | 90         | 115        | 150        | 175        | 210        | 260        | 315        | 450        | 550        | 700         | 860         |
| <b>A</b>        | <b>62</b>  | <b>74</b>  | <b>90</b>  | <b>115</b> | <b>150</b> | <b>175</b> | <b>210</b> | <b>260</b> | <b>315</b> | <b>450</b> | <b>550</b> | <b>700</b>  | <b>860</b>  |
| A               | 62         | 74         | 90         | 115        | 150        | 175        | 210        | 260        | 315        | 450        | 550        | 700         | 860         |
| A               | 62         | 74         | 90         | 115        | 150        | 175        | 210        | 260        | 315        | 450        | 550        | 700         | 860         |
| A               | 42         | 42         | 60         | 60         | 150        | 175        | 210        | 260        | 315        | 450        | 550        | 700         | 860         |
| A               | 40         | 40         | 58         | 58         | 120        | 140        | 150        | 180        | 240        | 400        | 500        | 630         | 700         |
| A               | –          | –          | 58         | 58         | 60         | 70         | 85         | 100        | 125        | 200        | 250        | –           | –           |
| kW              | 18,5       | 22         | 25         | 33         | 40         | 50         | 60         | 75         | 90         | 132        | 175        | 225         | 280         |
| kW              | 19         | 23         | 27         | 35         | 45         | 55         | 65         | 80         | 100        | 140        | 185        | 235         | 290         |
| <b>kW</b>       | <b>30</b>  | <b>37</b>  | <b>45</b>  | <b>55</b>  | <b>75</b>  | <b>90</b>  | <b>110</b> | <b>132</b> | <b>160</b> | <b>250</b> | <b>300</b> | <b>400</b>  | <b>500</b>  |
| kW              | 33         | 40         | 49         | 63         | 80         | 95         | 115        | 140        | 180        | 257        | 315        | 415         | 515         |
| kW              | 33         | 40         | 49         | 63         | 85         | 100        | 125        | 150        | 190        | 270        | 335        | 450         | 530         |
| kW              | 37         | 45         | 55         | 55         | 90         | 100        | 132        | 160        | 210        | 300        | 375        | 500         | 600         |
| kW              | 37         | 45         | 55         | 55         | 110        | 132        | 132        | 160        | 210        | 375        | 500        | 630         | 700         |
| kW              | –          | –          | 55         | 55         | 75         | 90         | 110        | 132        | 160        | 280        | 355        | –           | –           |

**Contactors**

**Data according to IEC 60947-4-1, EN 60947-4-1, VDE 0660**

| Main Contacts   | Type  | J7KN(G)-10(D) | J7KN(G)-14(D) | J7KN(G)-18(D) | J7KN(G)-22(D) | J7KN(G)-24 | J7KN(G)-32 | J7KN(G)-40  | J7KN-50   |      |
|---|---|---------------|---------------|---------------|---------------|------------|------------|-------------|-----------|------|
| <b>Utilization category AC4</b>                         | 220V A  | 12            | 15            | 18            | 18            | 24         | 30         | 40          | 50        |      |
| <b>Switching of squirrel cage motors, inching</b>       | 230V A  | 11,5          | 14,5          | 18            | 18            | 24         | 30         | 40          | 50        |      |
| Rated operational current $I_e$ open and enclosed       | 240V A  | 11            | 14            | 18            | 18            | 24         | 32         | 40          | 50        |      |
|   | <b>380-400V A</b>                                     | <b>10</b>     | <b>14</b>     | <b>18</b>     | <b>18</b>     | <b>24</b>  | <b>32</b>  | <b>40</b>   | <b>50</b> |      |
|   | 415V A  | 9             | 14            | 18            | 18            | 23         | 30         | 37          | 45        |      |
|   | 440V A  | 9             | 14            | 18            | 18            | 23         | 30         | 37          | 45        |      |
|   | 500V A  | 9             | 12            | 16            | 16            | 17,5       | 21         | 21          | 33        |      |
|   | 660-V A   | 7             | 9             | 9             | 9             | 17         | 20         | 20          | 31        |      |
|   | 690V A  | 6,5           | 8,5           | 8,5           | 8,5           | 17         | 20         | 20          | 31        |      |
|   | 1000V A   | —             | —             | —             | —             | —          | —          | —           | —         |      |
|   | Rated operational power of three-phase motors 50-60Hz | 220-230V kW   | 3             | 4             | 5             | 5          | 6          | 8,5         | 11        | 12,5 |
|   |   | 240V kW       | 3             | 4             | 5             | 5          | 7          | 9           | 11,5      | 13,5 |
| <b>380-400V kW</b>                                      |   | <b>4</b>      | <b>5,5</b>    | <b>7,5</b>    | <b>7,5</b>    | <b>11</b>  | <b>15</b>  | <b>18,5</b> | <b>22</b> |      |
| 415V kW   |   | 4,5           | 6             | 8,5           | 8,5           | 12         | 16         | 20          | 24        |      |
| 440V kW   |   | 4,5           | 6             | 8,5           | 8,5           | 12         | 16         | 20          | 24        |      |
| 500V kW   |   | 5,5           | 7,5           | 10            | 10            | 15         | 18,5       | 18,5        | 30        |      |
| 660-690V kW   |   | 5,5           | 7,5           | 10            | 10            | 15         | 18,5       | 18,5        | 30        |      |
| 1000V kW  | —   | —             | —             | —             | —             | —          | —          | —           |           |      |
| <b>Utilization category AC5a</b>                        |   |               |               |               |               |            |            |             |           |      |
| <b>Switching of gas discharge lamps</b>                 |   |               |               |               |               |            |            |             |           |      |
| Rated operational current $I_e$ per pole at 220/230V    |   |               |               |               |               |            |            |             |           |      |
| Fluorescent lamps, uncompensated and serial compensated | A 20  | 20            | 25            | 25            | 40            | 52         | 64         | 88          | 96        |      |
| parallel compensated                                    | A   | 7             | 9             | 9             | 9             | 18         | 22         | 22          | 30        |      |
| dual-connection   | A   | 22,5          | 22,5          | 28            | 28            | 45         | 58         | 72          | 98        |      |
| Metal halide lamps <sup>1</sup> , uncompensated         | A   | 12            | 15            | 19            | 19            | 30         | 39         | 48          | 66        |      |
| parallel compensated                                    | A   | 7             | 9             | 9             | 9             | 18         | 22         | 22          | 30        |      |
| Mercury-vapour lamps <sup>2</sup> , uncompensated       | A   | 22,5          | 25            | 28            | 28            | 45         | 58         | 72          | 99        |      |
| parallel compensated                                    | A   | 7             | 9             | 9             | 9             | 18         | 22         | 22          | 30        |      |
| Mixed light lamps <sup>3</sup>                          | A   | 20            | 20            | 25            | 25            | 40         | 52         | 64          | 88        |      |
| <b>Utilization category AC5b</b>                        |   |               |               |               |               |            |            |             |           |      |
| <b>Switching of incandescent lamps<sup>4</sup></b>      |   |               |               |               |               |            |            |             |           |      |
| Rated operational current $I_e$ per pole at 220/230V    | A   | 12,5          | 12,5          | 12,5          | 12,5          | 25         | 31         | 31          | 43        |      |

<sup>1</sup> Metal halide lamps and sodium-vapour lamps (high- and low-pressure lamps)

<sup>2</sup> High-pressure lamps

<sup>3</sup> Blended lamps, containing a mercury high-pressure unit and a tungsten helix in a fluorescent glass bulb (daylight lamps)

<sup>4</sup> Current inrush approx.  $16 \times I_e$

**Contactors**

Data according to IEC 60947-4-1, EN 60947-4-1, VDE 0660

| Type      | J7KN-62   | J7KN-74   | J7KN-90   | J7KN-115  | J7KN-151  | J7KN-176  | J7KN-210  | J7KN-260   | J7KN-316   | J7KN-450   | J7KN-550   | J7KN-700   | J7KN-860   |
|-----------|-----------|-----------|-----------|-----------|-----------|-----------|-----------|------------|------------|------------|------------|------------|------------|
| A         | 63        | 63        | 85        | 98        | 55        | 63        | 85        | 100        | 120        | 150        | 180        | 230        | 280        |
| A         | 62        | 62        | 85        | 98        | 55        | 63        | 85        | 100        | 120        | 150        | 180        | 230        | 280        |
| A         | 62        | 62        | 85        | 98        | 55        | 63        | 85        | 100        | 120        | 150        | 180        | 230        | 280        |
| <b>A</b>  | <b>62</b> | <b>62</b> | <b>85</b> | <b>85</b> | <b>55</b> | <b>63</b> | <b>85</b> | <b>100</b> | <b>120</b> | <b>150</b> | <b>180</b> | <b>230</b> | <b>280</b> |
| A         | 60        | 60        | 85        | 85        | 55        | 63        | 85        | 100        | 120        | 150        | 180        | 230        | 280        |
| A         | 55        | 55        | 85        | 85        | 55        | 63        | 85        | 100        | 120        | 150        | 180        | 230        | 280        |
| A         | 42        | 42        | 85        | 85        | —         | —         | —         | —          | —          | —          | —          | —          | —          |
| A         | 40        | 40        | 60        | 60        | —         | —         | —         | —          | —          | —          | —          | —          | —          |
| A         | 40        | 40        | 57,5      | 57,5      | —         | —         | —         | —          | —          | —          | —          | —          | —          |
| A         | —         | —         | —         | —         | —         | —         | —         | —          | —          | —          | —          | —          | —          |
| kW        | 18,5      | 18,5      | 25        | 30        | 15        | 18,5      | 25        | 30         | 37         | 45         | 51         | 68         | 80         |
| kW        | 19        | 19        | 27        | 32        | 15,5      | 19        | 26        | 31         | 38         | 47         | 53         | 71         | 83         |
| <b>kW</b> | <b>30</b> | <b>30</b> | <b>45</b> | <b>45</b> | <b>25</b> | <b>30</b> | <b>45</b> | <b>55</b>  | <b>63</b>  | <b>75</b>  | <b>90</b>  | <b>120</b> | <b>150</b> |
| kW        | 33        | 33        | 49        | 49        | 25        | 33        | 45        | 55         | 65         | 80         | 100        | 132        | 160        |
| kW        | 33        | 33        | 49        | 49        | 30        | 34        | 48        | 55         | 67         | 85         | 100        | 132        | 160        |
| kW        | 37        | 37        | 55        | 55        | 25        | 30        | 55        | 65         | 75         | 100        | 110        | 150        | 185        |
| kW        | 37        | 37        | 55        | 55        | 25        | 30        | 55        | 65         | 75         | 100        | 110        | 150        | 185        |
| kW        | —         | —         | —         | —         | —         | —         | —         | —          | —          | —          | —          | —          | —          |
| A         | 104       | —         | 100       | 120       | 120       | 140       | 180       | 220        | 280        | 360        | 450        | 570        | 700        |
| A         | 40        | 45        | 55        | 70        | 85        | 100       | 130       | 160        | 200        | 300        | 360        | 460        | 550        |
| A         | 108       | 117       | 112       | 144       | 120       | 140       | 180       | 220        | 280        | 360        | 450        | 570        | 700        |
| A         | 72        | 78        | 85        | 90        | 95        | 110       | 140       | 180        | 230        | 300        | 380        | 490        | 610        |
| A         | 40        | 45        | 55        | 70        | 75        | 85        | 110       | 140        | 170        | 260        | 300        | 400        | 480        |
| A         | 108       | 117       | 112       | 144       | 120       | 140       | 180       | 220        | 280        | 360        | 450        | 570        | 700        |
| A         | 40        | 45        | 55        | 70        | 75        | 85        | 110       | 140        | 170        | 260        | 300        | 400        | 480        |
| A         | 96        | 104       | 100       | 120       | 100       | 120       | 160       | 200        | 250        | 320        | 400        | 500        | 600        |
| A         | 56        | 56        | 69        | 75        | 100       | 120       | 160       | 190        | 220        | 260        | 315        | 440        | 500        |

**Contactors**

**Data according to IEC 60947-4-1, EN 60947-4-1, VDE 0660**

| Main Contacts                                      | Type                    | J7KN(G)-10(D) | J7KN(G)-14(D) | J7KN(G)-18(D) | J7KN(G)-22(D) | J7KN(G)-24 | J7KN(G)-32 | J7KN(G)-40 | J7KN-50 |
|--|-------------------------|---------------|---------------|---------------|---------------|------------|------------|------------|---------|
| <b>Utilization category AC6a</b>                   |                         |               |               |               |               |            |            |            |         |
| <b>Transformer primary switching</b>               |                         |               |               |               |               |            |            |            |         |
| at inrush  | n                       | 30            | 30            | 30            | 30            | 30         | 30         | 30         | 30      |
| Rated operational current I <sub>e</sub>           | 400V A                  | 4,5           | 5,5           | 7,5           | 7,5           | 10,5       | 13,5       | 13,5       | 20      |
| Rated operational power                            | 220-230V kVA            | 138           | 2,2           | 3             | 3             | 4,2        | 5,4        | 5,4        | 8       |
| dependent on inrush n                              | 200V kVA                | 1,9           | 2,3           | 3,1           | 3,1           | 4,3        | 5,6        | 5,6        | 8,3     |
|  | 380-400V kVA            | 3,1           | 3,8           | 5,2           | 5,2           | 7,3        | 9,3        | 9,3        | 13,5    |
| For different inrush-factors x                     | 415-440V- kVA           | 3,4           | 4,2           | 5,7           | 5,7           | 8          | 10,2       | 10,2       | 15      |
| use the following formula:                         | 500V kVA                | 3,9           | 4,8           | 6,5           | 6,5           | 9          | 11,5       | 11,5       | 17      |
| P <sub>x</sub> =P <sub>n</sub> <sup>n/x</sup>      | 660-690V kVA            | 5,4           | 6,5           | 9             | 9             | 12,5       | 16         | 16         | 24      |
| <b>Utilization category AC6b</b>                   |                         |               |               |               |               |            |            |            |         |
| <b>Switching of three-phase capacitors</b>         |                         |               |               |               |               |            |            |            |         |
| Maximum inrush current (peak value)                |                         | 35            | 25            | 20            | 20            | 25         | 25         | 25         | 25      |
| as multiple k of the capacitor rated current       | k                       |               |               |               |               |            |            |            |         |
| Rated operational I <sub>e</sub>                   | 500V A                  | 8             | 12            | 15,5          | 15,5          | 23         | 32         | 32         | 45      |
| Rated operational power                            | 220-230V kVAr           | 3             | 4,5           | 6             | 6             | 8,5        | 12         | 12         | 17      |
| (sinφ→1)   | 240V kVAr               | 3,5           | 5             | 6,5           | 6,5           | 9,5        | 13         | 13         | 18,5    |
|  | 380-400V kVAr           | 5             | 7,5           | 10            | 10            | 15         | 20         | 20         | 29      |
| For different multiples x                          | 415-440V kVAr           | 5,5           | 8             | 11            | 11            | 16         | 22         | 22         | 32      |
| use the following formula:                         | 500V kVAr               | 7             | 10            | 13            | 13            | 20         | 26         | 26         | 39      |
| P <sub>x</sub> =P <sub>k</sub> <sup>k/x</sup>      | 660-690V kVAr           | 7             | 10            | 13            | 13            | 20         | 26         | 26         | 40      |
| <b>Switching of reactive capacitor banks</b>       |                         |               |               |               |               |            |            |            |         |
| Rated operational current I <sub>e</sub>           | 690V A                  | 8             | 13            | 18            | 20            | 28         | 36         | 42         | 48      |
| Rated operational power                            | 220-230V kVAr           | 2,9           | 5             | 7             | 7,5           | 11         | 14         | 16         | 20      |
|  | 240V kVAr               | 3,1           | 5,4           | 7             | 8             | 11         | 14         | 17         | 20      |
|  | 380-400V kVAr           | 5             | 9             | 12,5          | 13            | 20         | 25         | 27,5       | 33,3    |
|  | 415-440V kVAr           | 5,5           | 9,5           | 13            | 14            | 22         | 27         | 30         | 36      |
|  | 500V kVAr               | 6             | 11            | 15            | 17            | 25         | 30         | 36         | 40      |
|  | 660-690V kVAr           | 8             | 15            | 20            | 22            | 33         | 41         | 48         | 55      |
|  | 750(850)V kVAr          | –             | –             | –             | –             | –          | –          | –          | –       |
| <b>Utilization category DC1</b>                    |                         |               |               |               |               |            |            |            |         |
| <b>Switching of resistive load</b>                 |                         |               |               |               |               |            |            |            |         |
| Time constant L/R≤1ms                              |                         | 20            | 25            | 32            | 32            | 50         | 65         | 80         | 110     |
| Rated operational current I <sub>e</sub>           | 1 pole 24V A            |               |               |               |               |            |            |            |         |
|  | 60V A                   | 20            | 25            | 32            | 32            | 50         | 65         | 80         | 110     |
|  | 110V A                  | 6             | 6             | 6             | 6             | 10         | 10         | 10         | 12      |
|  | 220V A                  | 0,8           | 0,8           | 0,8           | 0,8           | 1,4        | 1,4        | 1,4        | 1,4     |
|  | 3 poles in series 24V A | 20            | 25            | 32            | 32            | 50         | 65         | 8/0        | 110     |
|  | 60V A                   | 20            | 25            | 32            | 32            | 50         | 65         | 80         | 110     |
|  | 110V A                  | 20            | 25            | 32            | 32            | 50         | 65         | 80         | 110     |
|  | 220V A                  | 16            | 20            | 20            | 20            | 30         | 35         | 35         | 63      |
| <b>Utilization category DC3 and DC5</b>            |                         |               |               |               |               |            |            |            |         |
| <b>Switching of shunt motors and series motors</b> |                         |               |               |               |               |            |            |            |         |
| Time constant L/R≤15ms                             |                         | 20            | 25            | 32            | 32            | 50         | 65         | 80         | 110     |
| Rated operational current I <sub>e</sub>           | 1 pole 24V A            |               |               |               |               |            |            |            |         |
|  | 60V A                   | 6             | 6             | 6             | 6             | 30         | 30         | 30         | 60      |
|  | 110V A                  | 1,2           | 1,2           | 1,2           | 1,2           | 1,8        | 1,8        | 1,8        | 1,8     |
|  | 220V A                  | 0,2           | 0,2           | 0,2           | 0,2           | 0,2        | 0,2        | 0,2        | 0,25    |
|  | 3 poles in series 24V A | 20            | 25            | 32            | 32            | 50         | 65         | 80         | 110     |
|  | 60V A                   | 20            | 25            | 32            | 32            | 40         | 40         | 40         | 80      |
|  | 110V A                  | 20            | 20            | 20            | 20            | 40         | 40         | 40         | 80      |
|  | 220V A                  | 2,5           | 2,5           | 2,5           | 2,5           | 4          | 4          | 4          | 5       |

**Contactors**



Data according to IEC 60947-4-1, EN 60947-4-1, VDE 0660

| Type | J7KN-62 | J7KN-74          | J7KN-90 | J7KN-115 | J7KN-151 | J7KN-176 | J7KN-210 | J7KN-260 | J7KN-316 | J7KN-450 | J7KN-550 | J7KN-700 | J7KN-860 |
|------|---------|------------------|---------|----------|----------|----------|----------|----------|----------|----------|----------|----------|----------|
| n    | 30      | 30               | 30      | 30       | 30       | 30       | 30       | 30       | 30       | 30       | 30       | 30       | 30       |
| A    | 27      | 33               | 38      | 50       | 65       | 80       | 90       | 120      | 142      | 203      | 248      | 315      | 390      |
| kVA  | 10,7    | 13               | 15      | 20       | 25       | 30       | 34       | 45       | 54       | 77       | 95       | 120      | 148      |
| kVA  | 11,2    | 13,5             | 15,5    | 20,5     | 27       | 33       | 37       | 50       | 59       | 80       | 100      | 130      | 160      |
| kVA  | 18,5    | 22,5             | 26      | 34       | 45       | 55       | 60       | 80       | 95       | 140      | 170      | 210      | 270      |
| kVA  | 20,5    | 25               | 29      | 38       | 46       | 57       | 63       | 85       | 100      | 145      | 175      | 220      | 280      |
| kVA  | 23      | 28               | 33      | 43       | 55       | 69       | 75       | 100      | 120      | 170      | 210      | 270      | 330      |
| kVA  | 32      | 39               | 45      | 60       | 56       | 69       | 100      | 135      | 160      | 200      | 250      | 320      | 350      |
| k    | 25      | 20               | 20      | 20       | 20       | 20       | 25       | 20       | 20       | 20       | 20       | 20       | 20       |
| A    | 60      | 70               | 87      | 100      | 120      | 155      | 195      | 225      | 255      | 300      | 370      | 440      | 520      |
| kVAr | 24      | 28               | 33      | 38       | 45       | 60       | 75       | 90       | 100      | 115      | 145      | 170      | 200      |
| kVAr | 25      | 29               | 36      | 42       | 52       | 62       | 78       | 94       | 104      | 120      | 150      | 175      | 205      |
| kVAr | 39      | 46               | 57      | 65       | 80       | 100      | 130      | 155      | 170      | 200      | 250      | 300      | 350      |
| kVAr | 43      | 50               | 60      | 70       | 95       | 110      | 135      | 165      | 175      | 210      | 260      | 310      | 360      |
| kVAr | 50      | 58               | 70      | 80       | 100      | 130      | 170      | 194      | 220      | 260      | 320      | 380      | 450      |
| kVAr | 50      | 58               | 70      | 80       | 100      | 130      | 170      | 194      | 220      | 260      | 320      | 380      | 450      |
| A    | 72      | 108 <sup>1</sup> | 98      | 105      | 115      | 140      | 200      | 225      | 250      | 330      | 420      | 550      | 600      |
| kVAr | 28      | 33               | 35      | 40       | 43       | 53       | 76       | 85       | 95       | 125      | 160      | 209      | 228      |
| kVAr | 28      | 36               | 39      | 43       | 45       | 55       | 80       | 90       | 100      | 130      | 170      | 220      | 240      |
| kVAr | 50      | 75 <sup>1</sup>  | 68      | 75       | 75       | 90       | 130      | 145      | 160      | 210      | 270      | 350      | 390      |
| kVAr | 53      | 75 <sup>1</sup>  | 71      | 77       | 80       | 100      | 140      | 160      | 170      | 230      | 290      | 380      | 420      |
| kVAr | 60      | 75               | 85      | 90       | 95       | 120      | 170      | 190      | 210      | 280      | 350      | 450      | 500      |
| kVAr | 82      | 100              | 110     | 120      | 125      | 150      | 200      | 230      | 260      | 350      | 450      | 600      | 650      |
| kVAr | -       | -                | 115     | 125      | -        | -        | -        | -        | -        | -        | -        | -        | -        |
| A    | 120     | 130              | 160     | 200      | -        | -        | -        | -        | -        | -        | -        | -        | -        |
| A    | 120     | 130              | 160     | 200      | -        | -        | -        | -        | -        | -        | -        | -        | -        |
| A    | 12      | 12               | 20      | 25       | -        | -        | -        | -        | -        | -        | -        | -        | -        |
| A    | 1,4     | 1,4              | 2       | 2,5      | -        | -        | -        | -        | -        | -        | -        | -        | -        |
| A    | 120     | 130              | 160     | 200      | 200      | 250      | 350      | 400      | 450      | 600      | 760      | 1000     | 1100     |
| A    | 120     | 130              | 160     | 200      | 200      | 250      | 350      | 400      | 450      | 600      | 760      | 1000     | 1100     |
| A    | 120     | 130              | 160     | 200      | 150      | 170      | 250      | 280      | 315      | 400      | 480      | 560      | 630      |
| A    | 80      | 80               | 100     | 160      | 80       | 100      | 150      | 180      | 200      | 250      | 315      | 400      | 450      |
| A    | 120     | 130              | 160     | 200      | -        | -        | -        | -        | -        | -        | -        | -        | -        |
| A    | 60      | 60               | 85      | 100      | -        | -        | -        | -        | -        | -        | -        | -        | -        |
| A    | 1,8     | 1,8              | 2       | 2,5      | -        | -        | -        | -        | -        | -        | -        | -        | -        |
| A    | 0,25    | 0,25             | 0,5     | 0,5      | -        | -        | -        | -        | -        | -        | -        | -        | -        |
| A    | 120     | 130              | 160     | 200      | -        | -        | -        | -        | -        | -        | -        | -        | -        |
| A    | 80      | 80               | 100     | 110      | -        | -        | -        | -        | -        | -        | -        | -        | -        |
| A    | 80      | 80               | 100     | 110      | -        | -        | -        | -        | -        | -        | -        | -        | -        |
| A    | 5       | 5                | 7       | 8        | -        | -        | -        | -        | -        | -        | -        | -        | -        |

<sup>1</sup> Consider resistive load (I<sub>th</sub>). See page 10.

## Contactors

### Data according to IEC 60947-4-1, EN 60947-4-1, VDE 0660

| Main Contacts   | Type  | J7KN(G)-10(D)   | J7KN(G)-14(D) | J7KN(G)-18(D) | J7KN(G)-22(D) | J7KN(G)-24  | J7KN(G)-32 | J7KN(G)-40 | J7KN-50  | J7KN-62 | J7KN-74 |
|---|---|---|---------------|---------------|---------------|---|------------|------------|--|---------|---------|
| <b>Maximum ambient temperature</b>  |   |   |               |               |               |   |            |            |  |         |         |
| Operation   | open °C   | -40 to +60 (+90)* <sup>1</sup>  |               |               |               |   |            |            |  |         |         |
|   | enclosed °C                                       | -40 to +40  |               |               |               |   |            |            |  |         |         |
| with thermal overload relay   | open °C   | -25 to +60  |               |               |               |   |            |            |  |         |         |
|   | enclosed °C                                       | -25 to +40  |               |               |               |   |            |            |  |         |         |
| Storage   | °C  | -50 to +90  |               |               |               |   |            |            |  |         |         |
| <b>Short circuit protection</b>   |   |   |               |               |               |   |            |            |  |         |         |
| for contactors without thermal overload relay   |   |   |               |               |               |   |            |            |  |         |         |
| Coordination-type "1" according to IEC 60947-4-1  |   |   |               |               |               |   |            |            |  |         |         |
| Contact welding without hazard of persons   |   |   |               |               |               |   |            |            |  |         |         |
| max. fuse size  | gL (gG) A   | 63  | 63            | 63            | 63            | 80  | 80         | 80         | 160  | 160     | 160     |
| Coordination-type "2" according to IEC 60947-4-1  |   |   |               |               |               |   |            |            |  |         |         |
| Light contact welding accepted  |   |   |               |               |               |   |            |            |  |         |         |
| max. fuse size  | gL (gG) A   | 25  | 35            | 35            | 35            | 50  | 50         | 50         | 100  | 125     | 125     |
| Contact welding not accepted  |   |   |               |               |               |   |            |            |  |         |         |
| max. fuse size  | gL (gG) A   | 16  | 16            | 16            | 16            | 25  | 35         | 35         | 50   | 63      | 63      |
| For contactors with thermal overload relay the device with the smaller admissible backup fuse (contactor or thermal overload relay) determines the fuse size. |   |   |               |               |               |   |            |            |  |         |         |
| <b>Cable cross-sections</b>   |   |   |               |               |               |   |            |            |  |         |         |
| for contactors without thermal overload relay   |   |   |               |               |               |   |            |            |  |         |         |
| 1 cable per clamp   |   |   |               |               |               |   |            |            |  |         |         |
| main connector  |   |   |               |               |               |   |            |            |  |         |         |
|   | solid or stranded mm <sup>2</sup>                 |  0,75-6  |               |               |               |  1,5-25            |            |            |  4-50 |         |         |
|   | flexible mm <sup>2</sup>                          | 1-4   |               |               |               | 2,5-16  |            |            | 10-35  |         |         |
|   | flexible with multicore cable end mm <sup>2</sup> | 0,75-4  |               |               |               | 1,5-16  |            |            | 6-35   |         |         |
| 2 cables per clamp solid or stranded mm <sup>2</sup>  |   | 6+(1-6) / 4+(0,75-4)<br>2,5+(0,75-2,5) / 1,5+(0,75-1,5)   |               |               |               | 16+(2,5-16) / 10+(4-16)<br>6+(4-16) / 4+(2,5-16)  |            |            | 50+4 / 35+6 / 25+(6-16)<br>16+(6-16) / 10+(6-16)   |         |         |
| flexible mm <sup>2</sup>  |   | 6+(1,5-4) / 4+(1-4)<br>2,5+(0,75-2,5) / 1,5+(0,75-1,5)  |               |               |               | 16+(2,5-6) / 10+(4-10)<br>6+(4-16) / 4+(2,5-16)   |            |            | 50+(4-10) / 35+(4-16)<br>25+(4-25) / 16+(4-16)   |         |         |
| 1 cable per clamp main connector  |   | solid AWG 18-10<br>flexible AWG 18-10   |               |               |               | 16-10<br>14-4   |            |            | 12-10<br>10-0  |         |         |
| 2 cables per clamp  |   | solid AWG 10+(16-10) / 12+(18-12)<br>14+(18-14) / 16+(18-16)<br>flexible AWG 10+(14-10) / 12+(18-12)<br>14+(18-14) / 16+(18-16) |               |               |               | 10+(16-10) / 12+(18-12)<br>14+(18-14) / 16+(18-16)<br>4+(18-12) / 6+(18-8)<br>8+(18-8) / 10+(18-12) |            |            | 10+(12-10) / 12+12<br>1+(12-10) / 2+(8-12)<br>3+(12-8) / 4+(10-6)                        |         |         |
| <b>Frequency of operations z</b>  |   |   |               |               |               |   |            |            |  |         |         |
| Contactors without thermal overload relay   |   |   |               |               |               |   |            |            |  |         |         |
|   | without load 1/h                                  | 10000   |               |               |               | 7000  |            |            | 7000   |         |         |
|   | AC3, I <sub>e</sub> 1/h                           | 600   |               |               |               | 600   |            |            | 400  |         |         |
|   | AC4, I <sub>e</sub> 1/h                           | 120   |               |               |               | 120   |            |            | 120  |         |         |
|   | DC3, I <sub>e</sub> 1/h                           | 600   |               |               |               | 600   |            |            | 400  |         |         |
| <b>Mechanical life</b>  |   |   |               |               |               |   |            |            |  |         |         |
| AC operated   | S x 10 <sup>6</sup>                               | 10  |               |               |               | 10  |            |            | 10   |         |         |
| DC operated   | S x 10 <sup>6</sup>                               | 10  |               |               |               | 10  |            |            | 10   |         |         |
| DC solenoid operated (J7KNG)  | S x 10 <sup>6</sup>                               | 50  |               |               |               | 50  |            |            | -  |         |         |
| <b>Short time current</b>   |   |   |               |               |               |   |            |            |  |         |         |
|   | 10s-current A                                     | 96  | 120           | 144           | 176           | 184   | 240        | 296        | 450  | 504     | 592     |
|   | 120s-current A                                    | 42  | 52            | 58            | 66            | 80  | 97         | 110        | 195  | 203     | 222     |
| <b>Power loss per pole</b> at I <sub>e</sub> /AC3 400V W  |   |   |               |               |               |   |            |            |  |         |         |
| contact resistance  | mW  | 0,21  | 0,35          | 0,5           | 0,75          | 0,7   | 1,3        | 2          | 2,2  | 3,9     | 5,5     |
| <b>Resistance to shock acc. to IED 68-2-27</b>  |   |   |               |               |               |   |            |            |  |         |         |
| Shock time 20ms sine-wave   | NO g  | 10  | 10            | 10            | 10            | 8   | 8          | 8          | 8  | 8       | 8       |
|   | NC g  | 6   | 6             | 6             | 6             | -   | -          | -          | -  | -       | -       |

\*<sup>1</sup> With reduced control voltage range 0,9 up to 1,0 x U<sub>s</sub> and with reduced rated current I<sub>e</sub>/AC1 according to I<sub>e</sub>/AC3



**Contactors**

Data according to IEC 60947-4-1, EN 60947-4-1, VDE 0660

| Type                | J7KN-90                       | J7KN-115 | J7KN-151                            | J7KN-176 | J7KN-210 | J7KN-260                             | J7KN-316 | J7KN-450                             | J7KN-550                             | J7KN-700                             | J7KN-860                             |
|---------------------|-------------------------------|----------|-------------------------------------|----------|----------|--------------------------------------|----------|--------------------------------------|--------------------------------------|--------------------------------------|--------------------------------------|
| °C                  | -10 to +60(+90) <sup>*1</sup> |          | -25 to +55(+70) <sup>*2</sup>       |          |          |                                      |          |                                      |                                      |                                      |                                      |
| °C                  | -40 to +40                    |          | -25 to +40                          |          |          |                                      |          |                                      |                                      |                                      |                                      |
| °C                  | -25 to +60                    |          | -25 to +55                          |          |          |                                      |          |                                      |                                      |                                      |                                      |
| °C                  | -25 to +40                    |          | -25 to +40                          |          |          |                                      |          |                                      |                                      |                                      |                                      |
| °C                  | -50 to +90                    |          | -55 to +80                          |          |          |                                      |          |                                      |                                      |                                      |                                      |
| A                   | 250                           | 250      | 250                                 | 315      | 400      | 450                                  | 500      | 630                                  | 630                                  | 800                                  | 1000                                 |
| A                   | 160                           | 200      | 200                                 | 250      | 315      | 400                                  | 400      | 500                                  | 560                                  | —                                    | —                                    |
| A                   | 100                           | 125      | 160                                 | 200      | 250      | 315                                  | —        | —                                    | —                                    | —                                    | —                                    |
| mm <sup>2</sup>     |                               |          | <br>busbar<br>18 x 4<br>screw<br>M8 |          |          | <br>busbar<br>25 x 6<br>screw<br>M10 |          | <br>busbar<br>30 x 5<br>screw<br>M12 | <br>busbar<br>40 x 6<br>screw<br>M12 | <br>busbar<br>50 x 8<br>screw<br>M12 | <br>busbar<br>50 x 8<br>screw<br>M14 |
| mm <sup>2</sup>     | top below<br>0,5-95 + 10-120  |          |                                     |          |          |                                      |          |                                      |                                      |                                      |                                      |
| mm <sup>2</sup>     | 0,5-70 + 10-95                |          |                                     |          |          |                                      |          |                                      |                                      |                                      |                                      |
| AWG                 | top below<br>20-10 —          |          |                                     |          |          |                                      |          |                                      |                                      |                                      |                                      |
| AWG                 | 20-2/0 8-2/0                  |          |                                     |          |          |                                      |          |                                      |                                      |                                      |                                      |
| 1/h                 | 3000                          |          | 1200                                |          |          | 1200                                 |          | 1200                                 |                                      |                                      |                                      |
| 1/h                 | 300                           |          | —                                   |          |          |                                      |          |                                      |                                      |                                      |                                      |
| 1/h                 | 120                           |          | —                                   |          |          |                                      |          |                                      |                                      |                                      |                                      |
| 1/h                 | 300                           |          | —                                   |          |          |                                      |          |                                      |                                      |                                      |                                      |
| S x 10 <sup>6</sup> | 5                             |          | 10                                  |          |          | 5                                    |          | 5                                    |                                      |                                      |                                      |
| S x 10 <sup>6</sup> | 5                             |          | 10                                  |          |          | 5                                    |          | 5                                    |                                      |                                      |                                      |
| S x 10 <sup>6</sup> | —                             |          | —                                   |          |          |                                      |          |                                      |                                      |                                      |                                      |
| A                   | 680                           | 880      | 1200                                | 1400     | 1800     | 2200                                 | 2600     | 3600                                 | 4400                                 | 5600                                 | 6900                                 |
| A                   | 275                           | 330      | 500                                 | 575      | 800      | 900                                  | 1000     | 1400                                 | 1750                                 | 2200                                 | 2600                                 |
| W                   | 4,8                           | 7,9      | 9                                   | 11       | 88       | 11                                   | 14,9     | 26,3                                 | 33,3                                 | 49                                   | 59,2                                 |
| mW                  | 0,6                           | 0,5      | 0,4                                 | 0,35     | 0,18     | 0,16                                 | 0,15     | —                                    | —                                    | —                                    | —                                    |
| g                   | 7                             | 7        | —                                   | —        | —        | —                                    | —        | —                                    | —                                    | —                                    | —                                    |
| g                   | 5                             | 5        | —                                   | —        | —        | —                                    | —        | —                                    | —                                    | —                                    | —                                    |

\*1 With reduced control voltage range 0,9 up to 1,0 x U<sub>s</sub> and with reduced rated current I<sub>e</sub>/AC1 according to I<sub>e</sub>/AC3

\*2 With reduced control voltage range 1,0 x U<sub>s</sub> and with reduced rated current I<sub>e</sub>/AC1 according to I<sub>e</sub>/AC3

**Contactors**

**Data according to IEC 60947-4-1, EN 60947-4-1, VDE 0660**

| Auxiliary Contacts   | Type  | J7KN-10D/14D/18D/22D  | J7KNG-10/14/18/22 | J7KN(G)-24/32/40    | J7KN-50/62/74 |
|--|---|---|-------------------|---------------------|---------------|
| <b>Rated insulation voltage</b> $U_i$ <sup>*1</sup>                                  | V~  | 690   |                   | —                   | —             |
| <b>Thermal rated current</b> $I_{th}$ to 690V  |   |   |                   |                     |               |
| Ambient temperature  | 40°C A  | 10  | 16                | —                   | —             |
|  | 60°C A  | 6   | 12                | —                   | —             |
| <b>Utilization category AC15</b>   |   |   |                   |                     |               |
| Rated operational current $I_e$  | 220-240V A  | 3   | 12                | —                   | —             |
|  | 380-415V A  | 2   | 4                 | —                   | —             |
|  | 440V A  | 1,6   | 4                 | —                   | —             |
|  | 500V A  | 1,2   | 3                 | —                   | —             |
|  | 660-690V A  | 0,6   | 1                 | —                   | —             |
| <b>Utilization category DC13</b>   |   |   |                   |                     |               |
| Rated operational current $I_e$  | 60V A   | 3,5   | 8                 | —                   | —             |
|  | 110V A  | 0,5   | 1                 | —                   | —             |
|  | 220V A  | 0,1   | 0,1               | —                   | —             |
| <b>Short circuit protection</b>  |   | For contactors with thermal overload relay the device with the smaller admissible control fuse (contactor or thermal overload relay) determines the fuse. |                   |                     |               |
| Short-circuit current 1kA, contact welding not accepted                              |   |   |                   |                     |               |
| max. fuse size   | gL (gG) A   | 25  |                   | —                   | —             |
| <b>Control Circuit</b>   |   |   |                   |                     |               |
| <b>Power consumption of coils</b>  |   |   |                   |                     |               |
| AC operated  | inrush VA   | 33-45   |                   | 90-115              | 140-165       |
|  | sealed VA   | 7-10  |                   | 9-13                | 13-18         |
|  | W   | 2,6-3   |                   | 2,7-4               | 5,4-7         |
| DC operated  | inrush W  | 75  |                   | 140                 | 200           |
| double winding coil  | sealed W  | 2   |                   | 2                   | 6             |
| DC solenoid operated (J7KNG)   | inrush W  | 3   |                   | 4                   | —             |
|  | sealed W  | 3   |                   | 4                   | —             |
| <b>Operation range of coils</b>  |   |   |                   |                     |               |
| in multiples of control voltage $U_s$  |   |   |                   |                     |               |
|  | AC operated                                       | 0,85-1,1  |                   | 0,85-1,1            | 0,85-1,1      |
|  | DC operated                                       | 0,8-1,1   |                   | 0,8-1,1             | 0,8-1,1       |
| <b>Switching time at control voltage <math>U_s \pm 10\%</math> <sup>*2, *3</sup></b> |   |   |                   |                     |               |
| AC operated  | make time ms                                      | 8-16  |                   | 10-25               | 12-28         |
|  | release time ms                                   | 5-13  |                   | 8-15                | 8-15          |
|  | arc duration ms                                   | 10-15   |                   | 10-15               | 10-15         |
| DC operated  | make time ms                                      | 8-12  |                   | 10-20               | 12-23         |
|  | release time ms                                   | 8-13  |                   | 10-15               | 10-18         |
|  | arc duration ms                                   | 10-15   |                   | 10-15               | 10-15         |
| DC solenoid operated (J7KNG)   | make time ms                                      | 65-85   |                   | 65-85               | —             |
|  | release time ms                                   | 20-30 <sup>*4</sup>   |                   | 20-30 <sup>*4</sup> | —             |
|  | arc duration ms                                   | 10-15   |                   | 10-15               | —             |
| <b>Cable cross-section</b>   |   |   |                   |                     |               |
| Auxiliary connector  | solid mm <sup>2</sup>                             | 0,75-6  |                   | —                   | —             |
|  | flexible mm <sup>2</sup>                          | 1-4   |                   | —                   | —             |
|  | flexible with multicore cable end mm <sup>2</sup> | 0,75-4  |                   | —                   | —             |
| Magnet coil  | solid mm <sup>2</sup>                             | 0,75-2,5  |                   | 0,75-2,5            | 0,75-2,5      |
|  | flexible mm <sup>2</sup>                          | 0,5-2,5   |                   | 0,5-2,5             | 0,5-2,5       |
|  | flexible with multicore end mm <sup>2</sup>       | 0,5-1,5   |                   | 0,5-1,5             | 0,5-1,5       |
| Clamps per pole  |   | 2   |                   | 2                   | 2             |
| Auxiliary connector  | solid AWG   | 18-10   |                   | —                   | —             |
|  | flexible AWG                                      | 18-10   |                   | —                   | —             |
| Magnet coil  | solid AWG   | 14-12   |                   | 14-12               | 14-12         |
|  | flexible AWG                                      | 18-12   |                   | 18-12               | 18-12         |
| Clamps per pole  |   | 2   |                   | 2                   | 2             |

<sup>\*1</sup> Suitable for: earthed-neutral systems, overvoltage category I to IV, pollution degree 3 (standard-industry):  $U_{imp} = 8kV$ .  
Data for other conditions on request.

<sup>\*2</sup> Total breaking time = release time + arc duration

**Contactors**

Data according to IEC 60947-4-1, EN 60947-4-1, VDE 0660

| Type            | J7KN-90             | J7KN-115             | J7KN-151             | J7KN-176 | J7KN-210                         | J7KN-260  | J7KN-316 | J7KN-450             | J7KN-550 | J7KN-700 | J7KN-860 |
|-----------------|---------------------|----------------------|----------------------|----------|----------------------------------|-----------|----------|----------------------|----------|----------|----------|
| V~              | —                   | —                    | —                    | —        | —                                | —         | —        | 690                  | —        | 690      | —        |
| A               | —                   | —                    | —                    | —        | —                                | —         | —        | 10                   | —        | 10       | —        |
| A               | —                   | —                    | —                    | —        | —                                | —         | —        | —                    | —        | —        | —        |
| A               | —                   | —                    | —                    | —        | —                                | —         | —        | 3                    | —        | 3        | —        |
| A               | —                   | —                    | —                    | —        | —                                | —         | —        | 2                    | —        | 2        | —        |
| A               | —                   | —                    | —                    | —        | —                                | —         | —        | 1,5                  | —        | 1,5      | —        |
| A               | —                   | —                    | —                    | —        | —                                | —         | —        | 1,5                  | —        | 1,5      | —        |
| A               | —                   | —                    | —                    | —        | —                                | —         | —        | 1                    | —        | 1        | —        |
| A               | —                   | —                    | —                    | —        | —                                | —         | —        | —                    | —        | —        | —        |
| A               | —                   | —                    | —                    | —        | —                                | —         | —        | 1                    | —        | 1        | —        |
| A               | —                   | —                    | —                    | —        | —                                | —         | —        | 0,5                  | —        | 0,5      | —        |
| A               | —                   | —                    | —                    | —        | —                                | —         | —        | 10                   | —        | 10       | —        |
| VA              | 190-280             | 350                  | 360                  | —        | 800-950                          | 1350-1600 | —        | —                    | —        | —        | —        |
| VA              | —                   | 5                    | 5                    | —        | 9-11                             | 21-25     | —        | —                    | —        | —        | —        |
| W               | 2,5-5               | —                    | —                    | —        | —                                | —         | —        | —                    | —        | —        | —        |
| W               | 280                 | 350                  | 360                  | —        | 700-850                          | 1300-1550 | —        | —                    | —        | —        | —        |
| W               | 5                   | 5                    | 5                    | —        | 8-10                             | 18-22     | —        | —                    | —        | —        | —        |
| W               | —                   | —                    | —                    | —        | —                                | —         | —        | —                    | —        | —        | —        |
| W               | —                   | —                    | —                    | —        | —                                | —         | —        | —                    | —        | —        | —        |
| ms              | 0,85-1,1<br>0,8-1,1 | 0,85-1,1<br>0,85-1,1 | 0,85-1,1<br>0,85-1,1 | —        | 0,85-1,1<br>0,85-1,1             | —         | —        | 0,85-1,1<br>0,85-1,1 | —        | —        | —        |
| ms              | 20-35               | 30-60                | 40-60                | —        | 50-10                            | —         | —        | —                    | —        | —        | —        |
| ms              | 35-50               | 30-80                | 15-45                | —        | 150-200 / 500-1000 <sup>*1</sup> | —         | —        | —                    | —        | —        | —        |
| ms              | 10-15               | —                    | —                    | —        | —                                | —         | —        | —                    | —        | —        | —        |
| ms              | 20-35               | 30-60                | 40-60                | —        | —                                | —         | —        | —                    | —        | —        | —        |
| ms              | 35-50               | 30-80                | 15-45                | —        | —                                | —         | —        | —                    | —        | —        | —        |
| ms              | 10-15               | —                    | —                    | —        | —                                | —         | —        | —                    | —        | —        | —        |
| ms              | —                   | —                    | —                    | —        | —                                | —         | —        | —                    | —        | —        | —        |
| ms              | —                   | —                    | —                    | —        | —                                | —         | —        | —                    | —        | —        | —        |
| ms              | —                   | —                    | —                    | —        | —                                | —         | —        | —                    | —        | —        | —        |
| mm <sup>2</sup> | 0,75-2,5            | —                    | —                    | —        | 0,75-2,5                         | —         | —        | 0,75-2,5             | —        | —        | —        |
| mm <sup>2</sup> | 0,75-2,5            | —                    | —                    | —        | 0,75-2,5                         | —         | —        | 0,75-2,5             | —        | —        | —        |
| mm <sup>2</sup> | 0,5-1,5             | —                    | —                    | —        | —                                | —         | —        | —                    | —        | —        | —        |
| mm <sup>2</sup> | 0,75-2,5            | 1-2,5                | 1-2,5                | —        | 1-2,5                            | —         | —        | 1-2,5                | —        | —        | —        |
| mm <sup>2</sup> | 0,5-2,5             | 1-2,5                | 1-2,5                | —        | 1-2,5                            | —         | —        | 1-2,5                | —        | —        | —        |
| mm <sup>2</sup> | 0,5-1,5             | —                    | —                    | —        | —                                | —         | —        | —                    | —        | —        | —        |
|                 | 2                   | 2                    | 2                    | —        | 2                                | —         | —        | 2                    | —        | —        | —        |
| AWG             | 14-12               | —                    | —                    | —        | 16-12                            | —         | —        | 16-12                | —        | —        | —        |
| AWG             | 18-12               | —                    | —                    | —        | 16-12                            | —         | —        | 16-12                | —        | —        | —        |
| AWG             | 14-12               | 16-12                | 16-12                | —        | 16-12                            | —         | —        | 16-12                | —        | —        | —        |
| AWG             | 18-12               | 16-12                | 16-12                | —        | 16-12                            | —         | —        | 16-12                | —        | —        | —        |
|                 | 2                   | 2                    | 2                    | —        | 2                                | —         | —        | 2                    | —        | —        | —        |

<sup>\*3</sup> Values for delay of the release time of the make contact and the make time of the break contact will be increased, if magnet coils are protected against voltage peaks (varistor, RC-unit, diode-unit)

<sup>\*4</sup> with built-in coil suppressor

## Contactors for North America

### Data according to UL508

| Main Contacts (cULus)  | Type        | J7KN(G)-10(D) | J7KN(G)-14(D) | J7KN(G)-18(D) | J7KN(G)-22(D) | J7KN(G)-24 | J7KN(G)-32 | J7KN(G)-40 | J7KN-50 | J7KN-62 |
|--|-------------|---------------|---------------|---------------|---------------|------------|------------|------------|---------|---------|
| Rated operational current "General Use"                                      | A           | 25            | 25            | 30            | 30            | 50         | 65         | 80         | 110     | 120     |
| <b>Motor DOL 3-pase at 60Hz</b>  |             |               |               |               |               |            |            |            |         |         |
| Rated operational current  | 600V A      | 10            | 14            | 18            | 22            | 22         | 27         | 34         | 44      | 52      |
| Rated operational power  | 110-120V hp | 1½            | 2             | 2             | 3             | 5          | 5          | 7½         | 10      | 10      |
|  | 200V hp     | 3             | 3             | 5             | 5             | 7½         | 10         | 10         | 15      | 20      |
|  | 220-240V hp | 3             | 3             | 7½            | 7½            | 10         | 10         | 15         | 20      | 25      |
|  | 277V hp     | 3             | 5             | 7½            | 7½            | 7½         | 10         | 15         | 20      | 25      |
|  | 380-415V hp | 5             | 5             | 10            | 10            | 10         | 15         | 20         | 25      | 30      |
|  | 440-480V hp | 5             | 7½            | 10            | 15            | 15         | 20         | 25         | 30      | 40      |
|  | 550-600V hp | 7½            | 10            | 15            | 20            | 20         | 25         | 30         | 40      | 50      |
| <b>Motor DOL 1-pase at 60Hz</b>  |             |               |               |               |               |            |            |            |         |         |
| Rated operational current  | 600V A      | 10            | 14            | 18            | 22            | 22         | 27         | 34         | 44      | 52      |
| Rated operational power of AC motors at 60Hz (1ph)                           | 110-120V hp | ½             | ¾             | 1             | 1½            | 1½         | 2          | 3          | 3       | 5       |
|  | 200V hp     | 1             | 1,5           | 2             | 3             | 3          | 5          | 7½         | 7½      | 10      |
|  | 220-240V hp | 1½            | 2             | 3             | 3             | 5          | 5          | 7½         | 10      | 15      |
|  | 277V hp     | 2             | 3             | 3             | 5             | 5          | 7½         | 10         | 10      | 15      |
|  | 380-415V hp | 3             | 3             | 5             | 5             | 5          | 7½         | 10         | 15      | 20      |
|  | 440-480V hp | 3             | 5             | 5             | 7½            | 7½         | 10         | 15         | 20      | 25      |
|  | 550-600V hp | 3             | 5             | 7½            | 10            | 10         | 15         | 20         | 25      | 30      |
| <b>Motor DOL 3-pase according ANSI A17.5</b>                                 |             |               |               |               |               |            |            |            |         |         |
| Rated operational current  | 600V A      | —             | —             | —             | —             | 15         | 22         | —          | 27      | 37      |
| Rated operational power of 3-phase motors for elevators (500.000 operations) | 110-120V hp | —             | —             | —             | —             | 2          | 3          | —          | 3       | 5       |
|  | 200V hp     | —             | —             | —             | —             | 3          | 5          | —          | 7½      | 10      |
|  | 220-240V hp | —             | —             | —             | —             | 5          | 7½         | —          | 7½      | 10      |
|  | 440-480V hp | —             | —             | —             | —             | 10         | 15         | —          | 20      | 25      |
|  | 550-600V hp | —             | —             | —             | —             | 10         | 20         | —          | 25      | 30      |
| Rated current 2 series contacts  | 600V A      | —             | —             | —             | —             | 22         | 27         | —          | 44      | 52      |
| Fuse Class RK5/Short-circuit current   | A/kA        | 45/5          | 50/5          | 70/5          | 90/5          | 90/5       | 125/5      | 175/5      | 200/5   | 250/5   |
| Fuse Class T/Short-circuit current   | A/kA        | 45/100        | 50/100        | 70/100        | 90/100        | 110/100    | 150/100    | 150/100    | 175/100 | 175/100 |
| Rated voltage  | V           | 600           | 600           | 600           | 600           | 600        | 600        | 600        | 600     | 600     |
| <b>Auxiliary Contacts (cULus)</b>  |             | A600          | A600          | A600          | A600          | —          | —          | —          | —       | —       |

**Contactors for North America**

**Data according to UL508**

| Type | J7KN-74 | J7KN-90               | J7KN-115              | J7KN-151 | J7KN-176 | J7KN-210 | J7KN-260 | J7KN-316 | J7KN-450 | J7KN-550 | J7KN-700 | J7KN-860 |
|------|---------|-----------------------|-----------------------|----------|----------|----------|----------|----------|----------|----------|----------|----------|
| A    | 130     | 160                   | 200                   | 180      | 220      | 250      | 300      | 350      | 420      | 520      | 700      | 810      |
| A    | 66      | 85                    | 99                    | 125      | 150      |          |          |          | 300      | 400      | 550      | 700      |
| hp   | 10      | 15                    | 30                    | —        | —        | —        | —        | —        | —        | —        | —        | —        |
| hp   | 25      | 25                    | 35                    | 40       | 50       | 60       | 75       | 100      | 125      | 150      | 200      | 250      |
| hp   | 30      | 35                    | 40                    | 50       | 60       | 75       | 100      | 125      | 125      | 150      | 250      | 300      |
| hp   | 30      | —                     | —                     | —        | —        | —        | —        | —        | —        | —        | —        | —        |
| hp   | 40      | 50                    | 60                    | —        | —        | —        | —        | —        | —        | —        | —        | —        |
| hp   | 50      | 65                    | 75                    | 100      | 125      | 150      | 200      | 250      | 250      | 350      | 500      | 600      |
| hp   | 50      | 85                    | 100                   | 125      | 150      | 200      | 250      | 300      | 250      | 350      | 500      | 600      |
| A    | 66      | 86                    | 103                   | 125      | 150      | —        | —        | —        | —        | —        | —        | —        |
| hp   | 7½      | 8                     | 10                    | 15       | 25       | —        | —        | —        | —        | —        | —        | —        |
| hp   | 15      | 15                    | 20                    | —        | —        | —        | —        | —        | —        | —        | —        | —        |
| hp   | 15      | 20                    | 25                    | 25       | 30       | 40       | 50       | 50       | —        | —        | —        | —        |
| hp   | 15      | 20                    | 25                    | —        | —        | —        | —        | —        | —        | —        | —        | —        |
| hp   | 20      | 30                    | 40                    | —        | —        | —        | —        | —        | —        | —        | —        | —        |
| hp   | 25      | 40                    | 50                    | —        | —        | —        | —        | —        | —        | —        | —        | —        |
| hp   | 30      | 50                    | 60                    | —        | —        | —        | —        | —        | —        | —        | —        | —        |
| A    | —       | —                     | —                     | —        | —        | —        | —        | —        | —        | —        | —        | —        |
| hp   | —       | —                     | —                     | —        | —        | —        | —        | —        | —        | —        | —        | —        |
| hp   | —       | —                     | —                     | —        | —        | —        | —        | —        | —        | —        | —        | —        |
| hp   | —       | —                     | —                     | —        | —        | —        | —        | —        | —        | —        | —        | —        |
| hp   | —       | —                     | —                     | —        | —        | —        | —        | —        | —        | —        | —        | —        |
| hp   | —       | —                     | —                     | —        | —        | —        | —        | —        | —        | —        | —        | —        |
| A    | 66      | —                     | —                     | —        | —        | —        | —        | —        | —        | —        | —        | —        |
| A/kA | 300/5   | 300/10                | 300/10                | 300/10   | 350/10   | 400/18   | 500/18   | 500/18   | 1200/18  | 1200/18  | 2000/30  | 2000/30  |
| A/kA | 175/100 | 300/100 <sup>*1</sup> | 300/100 <sup>*1</sup> | —        | —        | —        | —        | —        | —        | —        | —        | —        |
| V    | 600     | 600                   | 600                   | 600      | 600      | 600      | 600      | 600      | 600      | 600      | 600      | 600      |
| —    | —       | —                     | —                     | —        | —        | —        | —        | —        | A600     | A600     | A600     | A600     |

<sup>\*1</sup> Class T and Class RK1

# Contactors

## Data according to IEC 60947-4-1, EN 60947-4-1, VDE 0660

### Contact Life

For selection of the suitable contactor-type according to supply voltage, power rating and application (utilization category AC1, AC3 or AC4) use contact life characteristic diagram.

For the most common supply voltages four scales of power ratings  $P_n$  are provided for each utilization category.

Select contactor-type according to utilization category **AC3** (breaking current  $I_a = I_e$ ) using the **motor rating** scales to the right, according to utilization category **AC4** (breaking current  $I_a = 6 \times I_e$ ) using the **motor rating** scales to the left.\*1

Select contactor-type according to utilization category **AC1** (breaking current  $I_a = I_e/AC1$ ) using the **breaking current** scale.\*1

For contactors frequently used under AC3/AC4-mixed service conditions calculate contact life with the formula:

$$M = \frac{AC3}{1 + \frac{\%AC4}{100} \times \left(\frac{AC3}{AC4} - 1\right)}$$

M = Contact life (switching cycles) for AC3/AC4-mixed operations

AC3 = Contact life (switching cycles) for AC3 operations (normal switching conditions). Breaking current  $I_a$  = rated motor current  $I_n$ .

AC4 = Contact life (switching cycles) for AC4 operations (inching).

Breaking current  $I_a$  = multiples of rated motor current  $I_n$ .

%AC4 = Percents of AC4-operations related to the total cycles.

1. Pay attention to the approved rated values of the selected contactor according to the national approvals

#### Motor Rating $P_n/AC4$

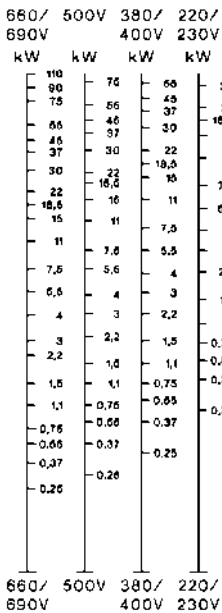

#### Motor Rating $P_n/AC3$

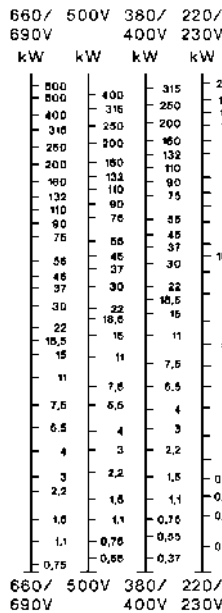

#### Breaking Current $I_a (=I_e/AC1)$

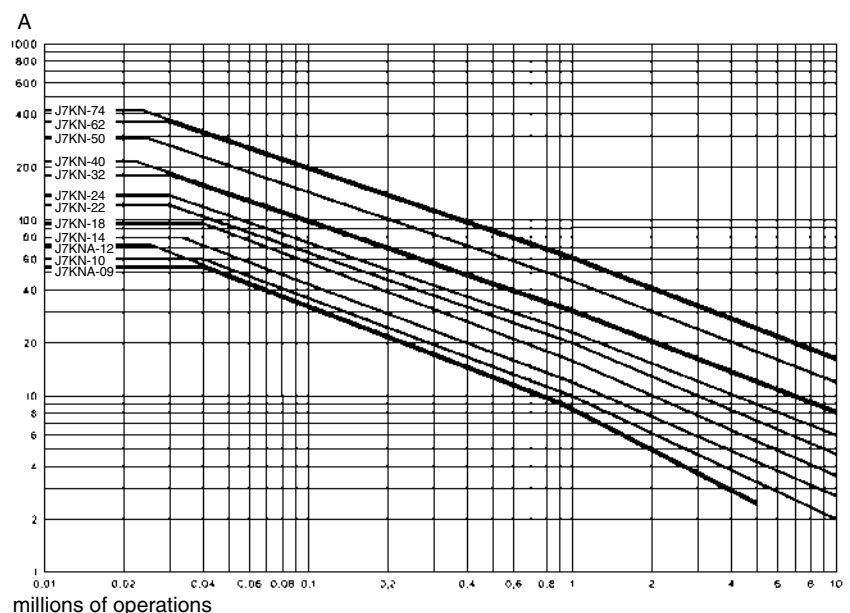

#### Motor Rating $P_n/AC4$

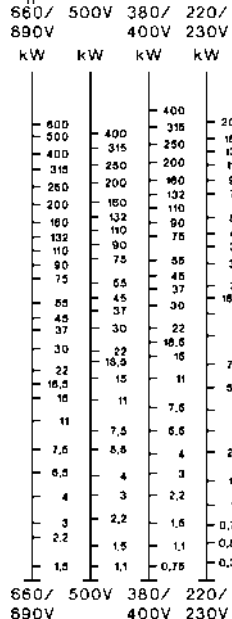

#### Motor Rating $P_n/AC3$

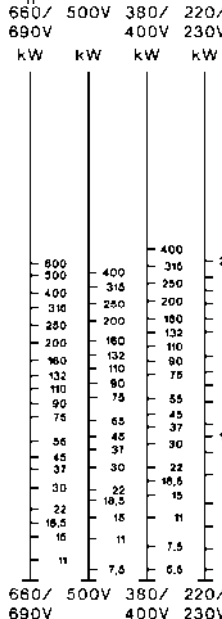

#### Breaking Current $I_a (=I_e/AC1)$

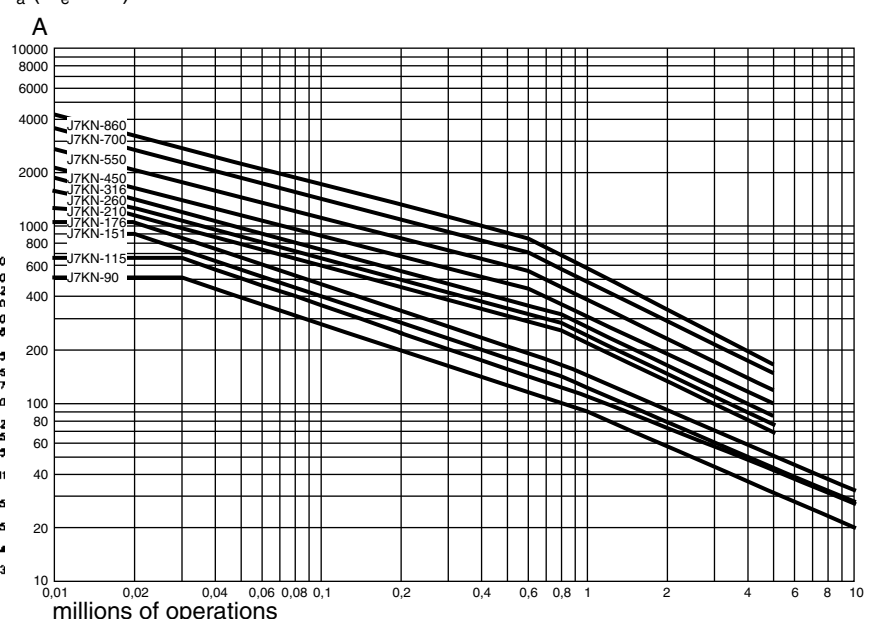

# Contactors

## Utilization Categories

For easier choice of devices and in order to make the comparison of different products simpler are utilization categories for contactors and motor-starters according to IEC 947-4-1 and VDE 0660 Part 102, for

control circuit devices and switching elements according to IEC 947-5-1 and VDE 0660 Part 200 determined. The table offers different utilization categories, typical applications and assorted test conditions.

| Type of current     | Category  | Typical applications   | Rated operational current | Test conditions for the number of on-load operating cycles |      |          |             |       |          | Test conditions for making and breaking capacities |      |          |             |       |          |
|---------------------|---|--|---------------------------|--|------|----------|-------------|-------|----------|--|------|----------|-------------|-------|----------|
|                     |   |  |                           | Make I/le  | U/Ur | cos      | Break Ic/le | Ur/Ur | cos      | Make I/le  | U/Ur | cos      | Break Ic/le | Ur/Ur | cos      |
| Alternating Current | AC1   | Non-inductive or slightly inductive loads-resistance furnaces                    | all values                | 1  | 1    | 0.95     | 1           | 1     | 0.95     | 1.5  | 1.05 | 0.8      | 1.5         | 1.05  | 0.8      |
|                     | AC2   | Slip-ring motors: starting, switching off  | all values                | 2.5  | 1    | 0.65     | 2.5         | 1     | 0.65     | 4  | 1.05 | 0.65     | 4           | 1.05  | 0.65     |
|                     | AC3   | Squirrel-cage motors: starting, switching off motors during running              | 17A< le 17A               | 6  | 1    | 0.65     | 1           | 0.17  | 0.65     | 10   | 1.05 | 0.45     | 8           | 1.05  | 0.45     |
|                     |   |  | le 100A                   | 6  | 1    | 0.35     | 1           | 0.17  | 0.35     | 10   | 1.05 | 0.45     | 8           | 1.05  | 0.45     |
|                     |   |  | le> 100A                  | 6  | 1    | 0.35     | 1           | 0.17  | 0.35     | 10   | 1.05 | 0.35     | 8           | 1.05  | 0.35     |
|                     | AC4   | Squirrel-cage motors: starting, plugging, inching                                | 17A< le 17A               | 6  | 1    | 0.65     | 6           | 1     | 0.65     | 12   | 1.05 | 0.45     | 10          | 1.05  | 0.45     |
|                     |   |  | le 100A                   | 6  | 1    | 0.35     | 6           | 1     | 0.35     | 12   | 1.05 | 0.45     | 10          | 1.05  | 0.45     |
|                     |   |  | le> 100A                  | 6  | 1    | 0.35     | 6           | 1     | 0.35     | 12   | 1.05 | 0.35     | 10          | 1.05  | 0.35     |
|                     | AC5a  | Switching of electric discharge lamp controls                                    | all values                | -  | -    | -        | -           | -     | -        | 3  | 1.05 | 0.45     | 3           | 1.05  | 0.45     |
|                     | AC5b  | Switching of incandescent lamps  | all values                | -  | -    | -        | -           | -     | -        | 1.5  | 1.05 | 1)       | 4           | 1.05  | 1)       |
|                     | AC6a  | Switching of transformers  | le 100A                   | -  | -    | -        | -           | -     | -        | 4.5  | 1.05 | 0.45     | 3.6         | 1.05  | 0.45     |
|                     |   |  | le> 100A                  | -  | -    | -        | -           | -     | -        | 4.5  | 1.05 | 0.35     | 3.6         | 1.05  | 0.35     |
|                     | AC6b  | Switching of capacitor banks   | -                         | -  | -    | -        | -           | -     | -        | 2)   |      |          | 2)          |       |          |
|                     | AC7a  | Slightly inductive loads in household appliances and similar applications        | all values                | -  | -    | -        | -           | -     | -        | 1.5  | 1.05 | 0.8      | 1.5         | 1.05  | 0.8      |
|                     | AC7b  | Motor loads for household applications   | le 100A                   | -  | -    | -        | -           | -     | -        | 8  | 1.05 | 0.45     | 6           | 1.05  | 0.45     |
| le> 100A            |   |  | -                         | -  | -    | -        | -           | -     | 8        | 1.05   | 0.35 | 6        | 1.05        | 0.35  |          |
| AC8a                | Hermetic refrigerant compressor motor control with manual resetting of overload releases    | le 100A  | -                         | -  | -    | -        | -           | -     | 6        | 1.05   | 0.45 | 6        | 1.05        | 0.45  |          |
|                     |   | le> 100A   | -                         | -  | -    | -        | -           | -     | 6        | 1.05   | 0.35 | 6        | 1.05        | 0.35  |          |
| AC8b                | Hermetic refrigerant compressor motor control with automatic resetting of overload releases | le 100A  | -                         | -  | -    | -        | -           | -     | 6        | 1.05   | 0.45 | 6        | 1.05        | 0.45  |          |
|                     |   | le> 100A   | -                         | -  | -    | -        | -           | -     | 6        | 1.05   | 0.35 | 6        | 1.05        | 0.35  |          |
| AC12                | Control of resistive loads and solid state loads with isolation by opto couplers            | all values   | -                         | -  | -    | -        | -           | -     | 1        | 1  | 0.9  | 1        | 1           | 0.9   |          |
| AC13                | Control of solid state loads with transformer isolation                                     | all values   | -                         | -  | -    | -        | -           | -     | 10       | 1.1  | 0.65 | 1.1      | 1.1         | 0.65  |          |
| AC14                | Control of small electromagnetic loads (<=72VA)   | -  | -                         | -  | -    | -        | -           | -     | 6        | 1.1  | 0.7  | 6        | 1.1         | 0.7   |          |
| AC15                | Control of electromagnetic load (>72VA)   | -  | 10                        | 1  | 0.7  | 1        | 1           | 0.4   | 10       | 1.1  | 0.3  | 10       | 1.1         | 0.3   |          |
|                     |   |  |                           | Make I/le  | U/Ur | L/R [ms] | Break Ic/le | Ur/Ur | L/R [ms] | Make I/le  | U/Ur | L/R [ms] | Break Ic/le | Ur/Ur | L/R [ms] |
| Direct Current      | DC1   | Non-inductive or slightly inductive loads resistance furnaces                    | all values                | 1  | 1    | 1        | 1           | 1     | 1        | 1.5  | 1.05 | 1        | 1.5         | 1.05  | 1        |
|                     | DC3   | Shunt-motors: starting, plugging, inching dynamic braking of d.c. motors         | all values                | 2.5  | 1    | 2        | 2.5         | 1     | 2        | 4  | 1.05 | 2.5      | 4           | 1.05  | 2.5      |
|                     | DC5   | Series-motors: starting, plugging, inching dynamic braking of d.c. motors        | all values                | 2.5  | 1    | 7.5      | 2.5         | 1     | 7.5      | 4  | 1.05 | 15       | 4           | 1.05  | 15       |
|                     | DC6   | Switching of incandescent lamps  | all values                | -  | -    | -        | -           | -     | -        | 1.5  | 1.05 | 1)       | 4           | 1.05  | 1)       |
|                     | DC12  | Control of resistive loads and solid state loads with isolation by opto couplers | all values                | -  | -    | -        | -           | -     | -        | 1  | 1    | 1        | 1           | 1     | 1        |
|                     | DC13  | Control of electromagnets  | all values                | 1  | 1    | 300      | 1           | 1     | 300      | 1.1  | 1.1  | 300      | 1.1         | 1.1   | 300      |
|                     | DC14  | Control of electromagnetic loads having economy resistors in circuit             | all values                | -  | -    | -        | -           | -     | -        | 10   | 1.1  | 15       | 10          | 1.1   | 15       |

U<sub>r</sub> Rated operational voltage, U Voltage before make, U<sub>r</sub> Recovery voltage, I<sub>r</sub> Rated operational current, I<sub>m</sub> Current make, I<sub>b</sub> Current broken

- 1) Test with incandescent lamps
- 2) Test conditions according to standard

## Accessories

### Data according to IEC 60947-4-1, EN 60947-5-1, VDE 0660

| Auxiliary Contacts   | Type  | J73KN-B  | J73KN-B...A | J73KN-C  | J73KN-D  | J74KN-B-TP... |
|--|---|----------|-------------|----------|----------|---------------|
| Rated insulation voltage $U_i^{*1}$  | V~  | 690      | 690         | 690      | 690      | 690           |
| Thermal rated current $I_{th}$ to 690V   |   |          |             |          |          |               |
| Ambient temperature  | 40°C A  | 10       | 25          | 10       | 10       | 10            |
|  | 60°C A  | 6        | 20          | 6        |          | -             |
| Frequency of operations z  | 1/h   | 3000     | 3000        | 3000     | 3000     | 1200          |
| Mechanical life  | $S \times 10^6$                                   | 10       | 10          | 10       | 10       | 1             |
| Power loss per pole at $I_g/AC1$   | W   | 0,5      | 1,5         | 0,5      | -        | -             |
| Utilization category AC15  |   |          |             |          |          |               |
| Rated operational current $I_g$  |   |          |             |          |          |               |
|  | 220-240V A  | 3        | 6           | 3        | 3        | 4             |
|  | 380-400V A  | 2        | 3           | 2        | 2        | 3             |
|  | 440V A  | 1,6      | 2           | 1,6      | 1,5      | 2             |
|  | 500V A  | 1,2      | 2           | 1,2      | 1,5      | 2             |
|  | 660-690V A  | 0,6      | 1           | 0,6      | 1        | 2             |
| Utilization category DC13  |   |          |             |          |          |               |
| Rated operational current $I_g$  |   |          |             |          |          |               |
|  | 60V A   | 2        | 8           | 2        | -        | 2,5           |
|  | 110V A  | 0,4      | 1           | 0,4      | 1        | 1,5           |
|  | 220V A  | 0,1      | 0,1         | 0,1      | 0,5      | 0,2           |
| Short circuit protection   |   |          |             |          |          |               |
| short-circuit current 1kA, contact welding not accepted max. fuse size   | gL (gG) A   | 20       | 25          | 20       | 10       | 10            |
| For contactors with thermal overload relay or auxiliary contacts the device with the smaller admissible control fuse (contactor or thermal overload relay) determines the fuse size. |   |          |             |          |          |               |
| Cable cross-sections   |   |          |             |          |          |               |
|  | solid or stranded mm <sup>2</sup>                 | 0,75-2,5 | 0,75-2,5    | 0,75-2,5 | 0,75-2,5 | 1-2,5         |
|  | flexible mm <sup>2</sup>                          | 0,75-2,5 | 0,75-2,5    | 0,75-2,5 | 0,75-2,5 | 0,75-2,5      |
|  | flexible with multicore cable end mm <sup>2</sup> | 0,5-1,5  | 0,5-1,5     | 0,5-1,5  | -        | 0,75-2,5      |
| Cables per clamp   |   | 2        | 2           | 2        | 2        | 2             |

\*1 Suitable for: earthed-neutral systems, overvoltage category I to IV, pollution degree 3 (standard-industry):  $U_{imp} = 8kV$ . Data for other conditions on request









### Data according to CSA, UL and CUL

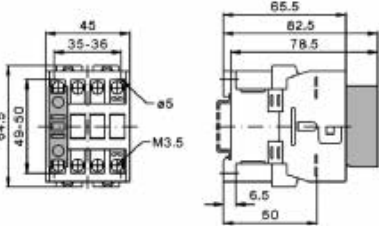
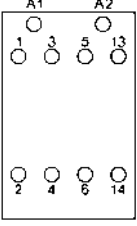
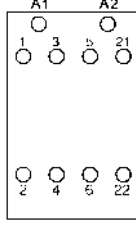
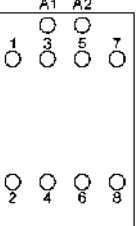

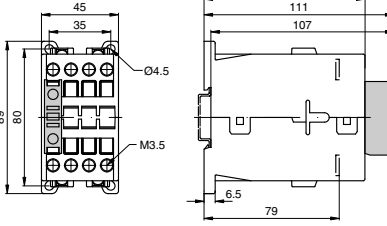
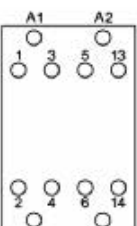
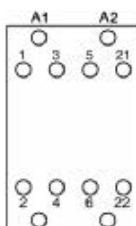
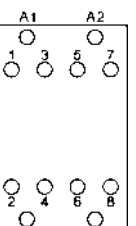

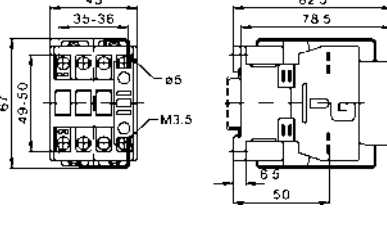
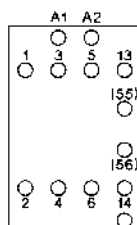
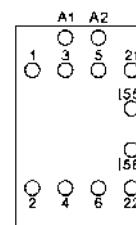
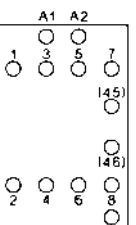

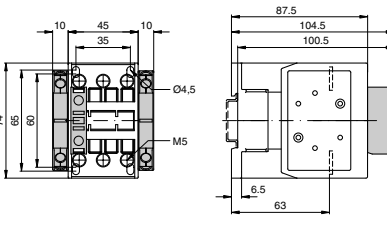
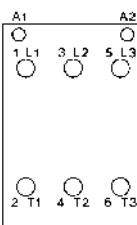
| Auxiliary Contacts                      | Type      | J73KN-B | J73KN-B...A | J73KN-C | J73KN-D | J74KN-B-TP... |
|---|-----------|---------|-------------|---------|---------|---------------|
| Rated operational current „General Use“ | A         | 10      | 16          | 10      | 10      | 10            |
| Rated operational voltage               | max. V AC | 600     | 600         | 600     | 600     | 600           |
| Auxiliary Contacts                      |           | A600    | A600        | A600    | A600    | A600          |

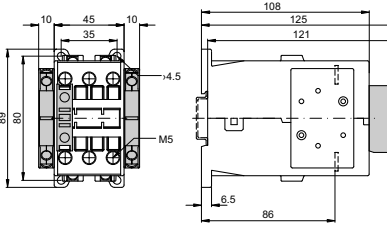
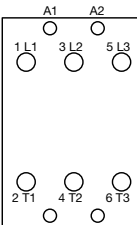

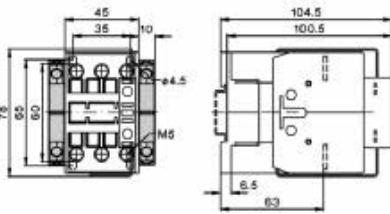
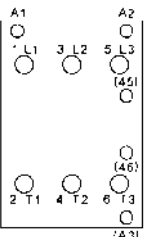

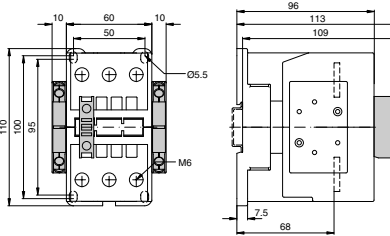
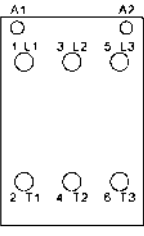

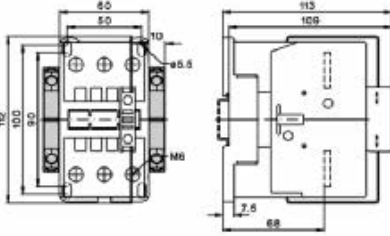
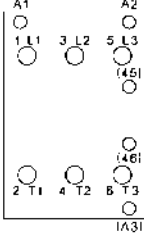
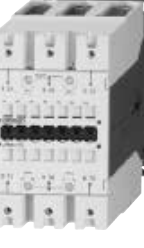
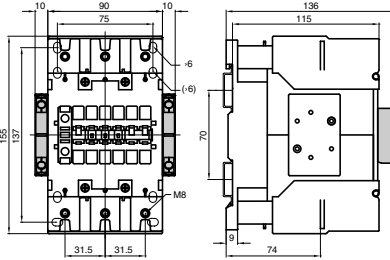
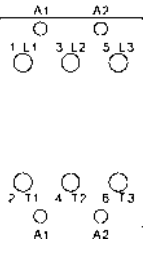
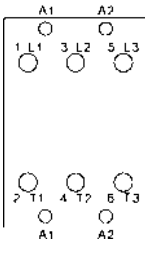
■ Dimensions / Position of Terminals

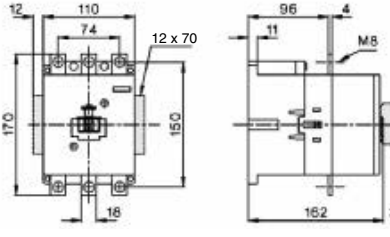
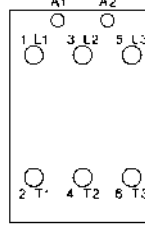
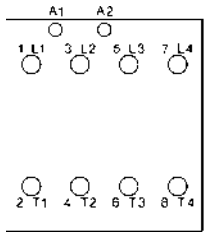
Contactors

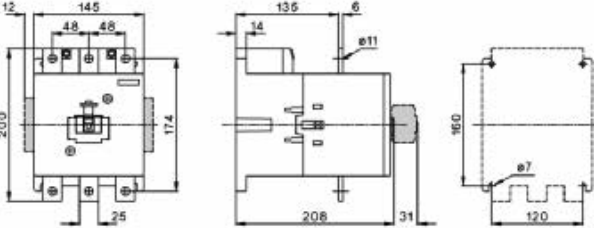
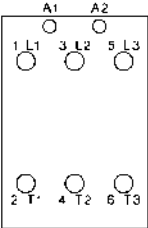
|   |   |   |   |   |
|---|---|---|---|---|
|    | <p><b>J7KN-10D/14D/18D/22D(-4)...</b></p>  | <p><b>J7KN-10D-10 to J7KN-22D-10</b></p>   | <p><b>J7KN-10D-01 to J7KN-22D-01</b></p>   | <p><b>J7KN-10D-4_ to J7KN-22D-4_</b></p>   |
|    | <p><b>J7KNG-10/14/18/22(-4)...D</b></p>    | <p><b>J7KNG-10-10...D<br/>J7KNG-14-10...D<br/>J7KNG-18-10...D<br/>J7KNG-22-10...D</b></p>    | <p><b>J7KNG-10-01...D<br/>J7KNG-14-01...D<br/>J7KNG-18-01...D<br/>J7KNG-22-01...D</b></p>    | <p><b>J7KNG-10-4_...D<br/>J7KNG-14-4_...D<br/>J7KNG-18-4_...D<br/>J7KNG-22-4_...D</b></p>    |
|   | <p><b>J7KN-10D/14D/18D/22D...D</b></p>    | <p><b>J7KN-10D-10...D<br/>J7KN-14D-10...D<br/>J7KN-18D-10...D<br/>J7KN-22D-10...D</b></p>  | <p><b>J7KN-10D-01...D<br/>J7KN-14D-01...D<br/>J7KN-18D-01...D<br/>J7KN-22D-01...D</b></p>  | <p><b>J7KN-10D-4_...D<br/>J7KN-14D-4_...D<br/>J7KN-18D-4_...D<br/>J7KN-22D-4_...D</b></p>  |
|  | <p><b>J7KN-24/32/40...</b></p>           | <p><b>J7KN-24<br/>J7KN-32<br/>J7KN-40</b></p>    |   |   |
|  | <p><b>J7KNG-24/32/40...D</b></p>         | <p><b>J7KNG-24...D<br/>J7KNG-32...D<br/>J7KNG-40...D</b></p>                               |   |   |

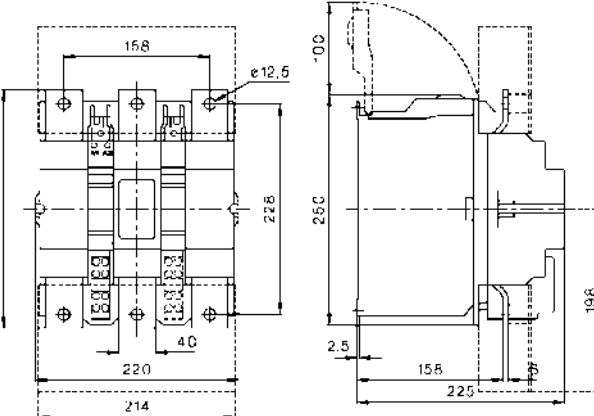
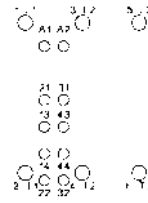
|   |   |  |  |   |
|---|---|--|--|---|
|    | <p><b>J7KN-24/32/40...D</b></p>              | <p><b>J7KN-24...D<br/>J7KN-32...D<br/>J7KN-40...D</b></p>   |  |   |
|    | <p><b>J7KN-50/62/74</b></p>                  | <p><b>J7KN-50<br/>J7KN-62<br/>J7KN-74</b></p>               |  |   |
|   | <p><b>J7KN-50/62/74...D</b></p>             | <p><b>J7KN-50...D<br/>J7KN-62...D<br/>J7KN-74...D</b></p>  |  |   |
|  | <p><b>J7KN-90...<br/>J7KN-115...</b></p>   | <p><b>J7KN-90<br/>J7KN-115</b></p>                        | <p><b>J7KN-90...D<br/>J7KN-115...D</b></p>  |   |
|  | <p><b>J7KN-151...<br/>J7KN-176...</b></p>  | <p><b>J7KN-151<br/>J7KN-176</b></p>                     |  | <p><b>J7KN-151<br/>J7KN-176</b></p>  |

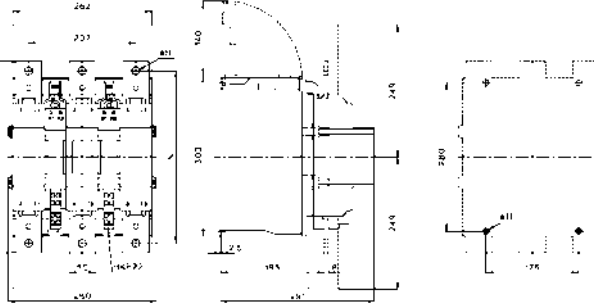
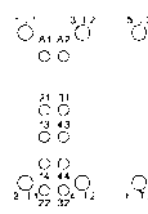
|   |  |   |  |
|---|--|---|--|
|    | <p><b>J7KN-210...</b><br/><b>J7KN-260...</b><br/><b>J7KN-316...</b></p>  | <p><b>J7KN-210...</b><br/><b>J7KN-260...</b><br/><b>J7KN-316...</b></p>  |  |
|   | <p><b>J7KN-450...</b><br/><b>J7KN-550...</b></p>                         | <p><b>J7KN-450...</b><br/><b>J7KN-550...</b></p>                         |  |
|  | <p><b>J7KN-700...</b><br/><b>J7KN-860...</b></p>                       | <p><b>J7KN-700...</b><br/><b>J7KN-860...</b></p>                       |  |

**Auxiliary contacts blocks**

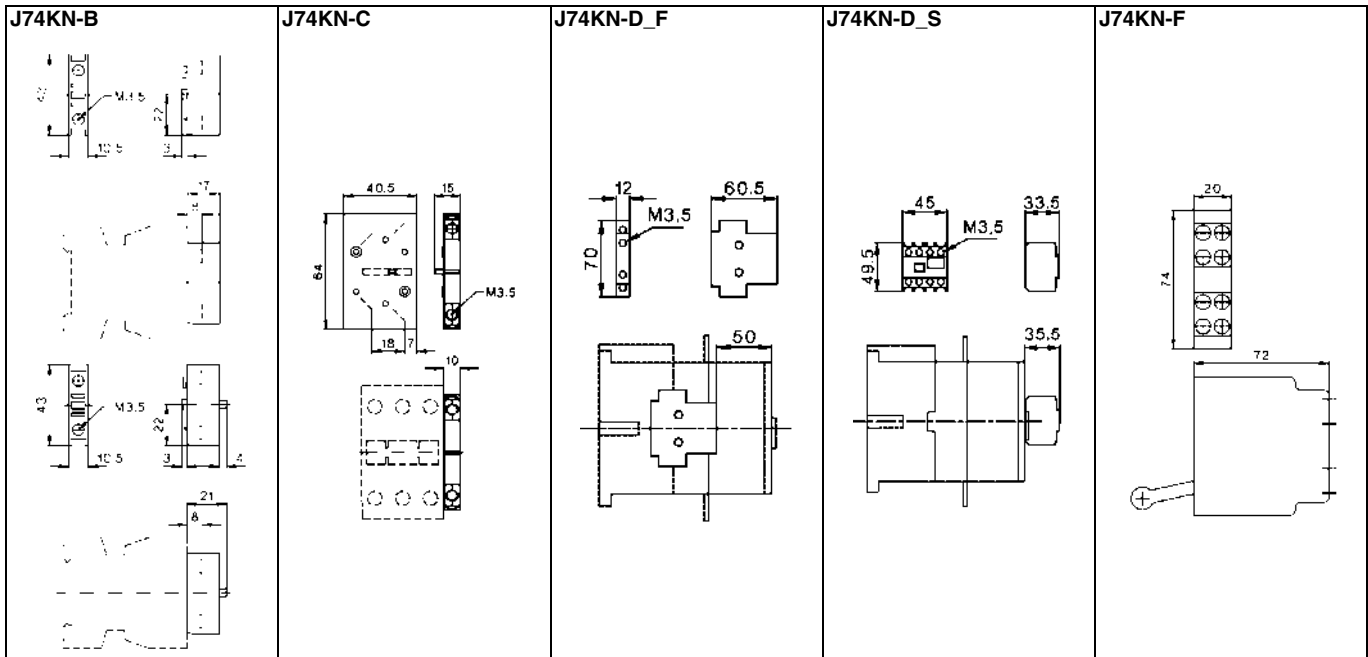

**Pneumatic Timer**

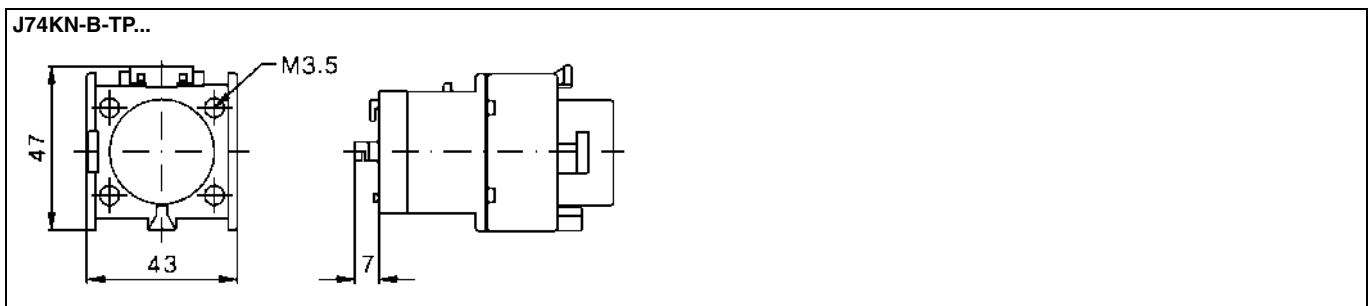

**Mechanical Interlocks**

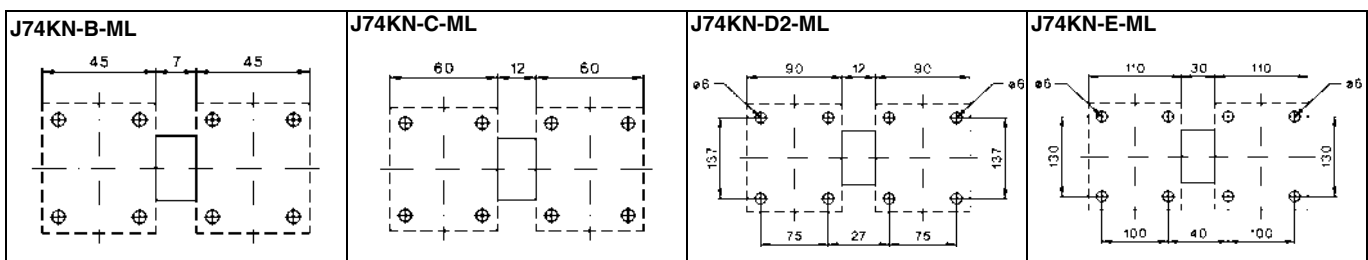

**Suppressor Units**

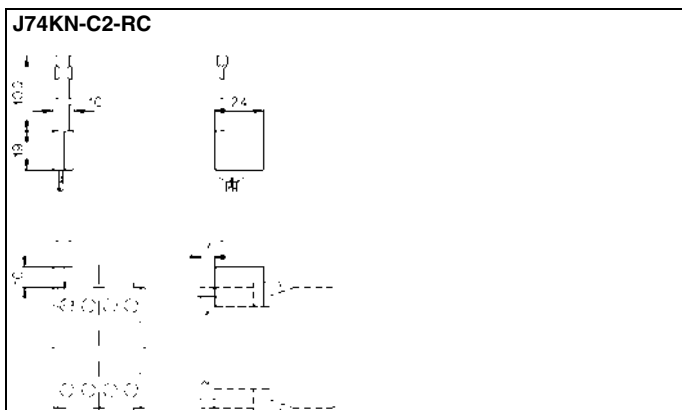

**Additional Terminals**

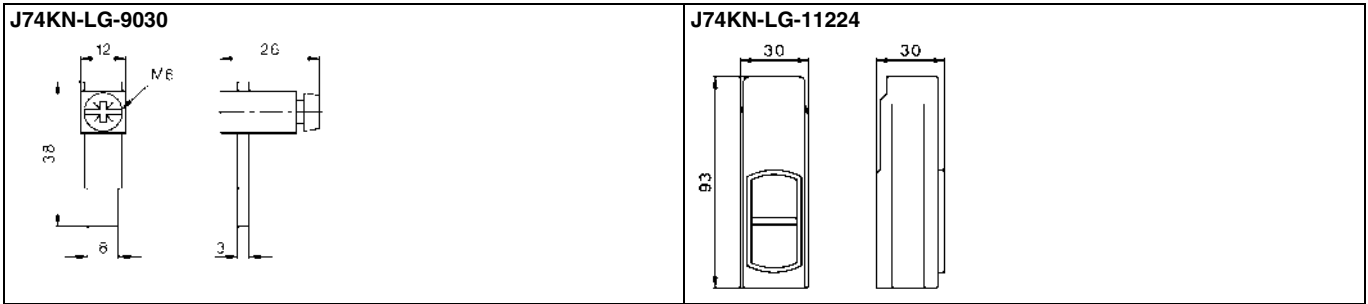

**Terminals Cover**

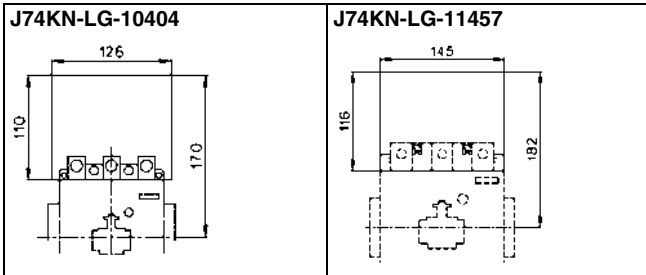

**Marking Systems**

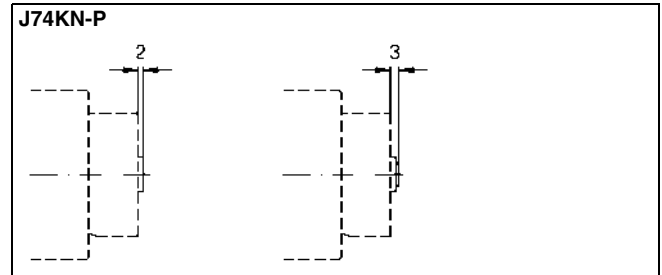

**Wiring Systems**

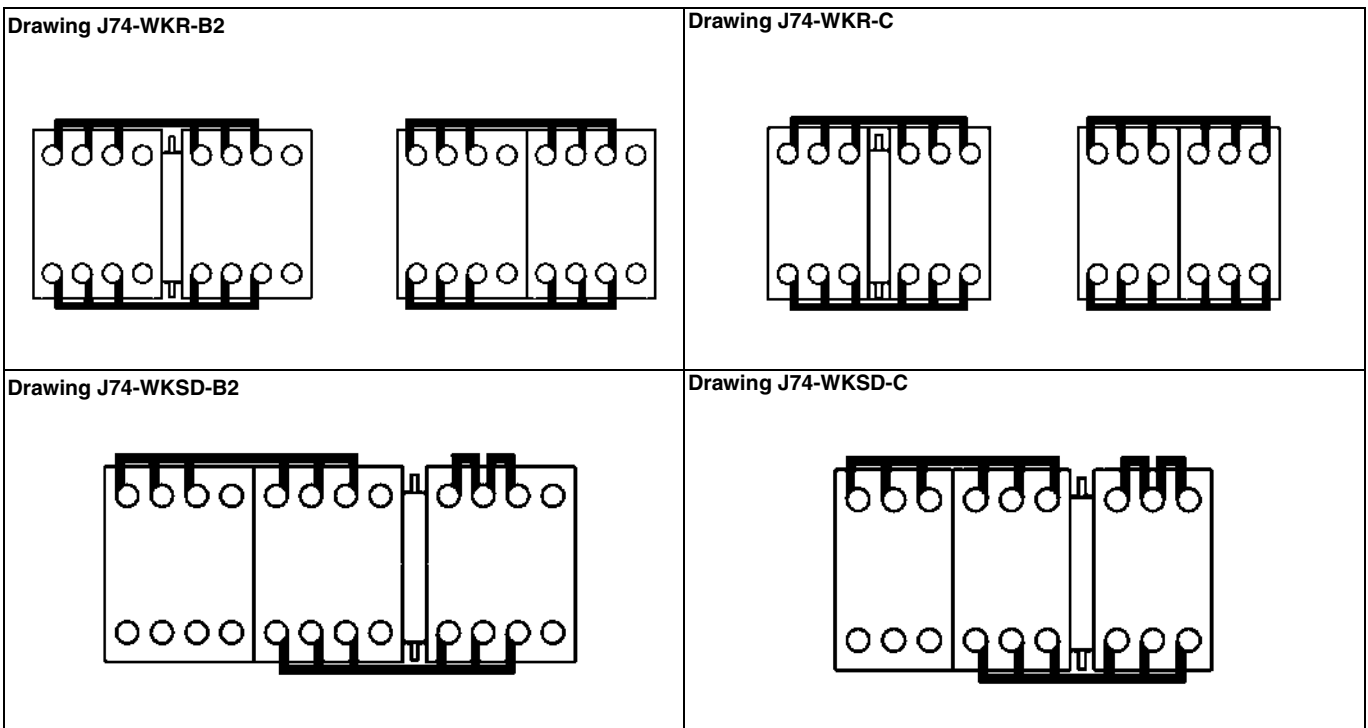

Do not use/install these products before having read the applicable precautions as listed in Cat. No. J09-EN-01 available from [www.europe.omron.com](http://www.europe.omron.com) or on request from OMRON local sales office.

ALL DIMENSIONS SHOWN ARE IN MILLIMETERS.



Компания «ЭлектроПласт» предлагает заключение долгосрочных отношений при поставках импортных электронных компонентов на взаимовыгодных условиях!

Наши преимущества:

- Оперативные поставки широкого спектра электронных компонентов отечественного и импортного производства напрямую от производителей и с крупнейших мировых складов;
- Поставка более 17-ти миллионов наименований электронных компонентов;
- Поставка сложных, дефицитных, либо снятых с производства позиций;
- Оперативные сроки поставки под заказ (от 5 рабочих дней);
- Экспресс доставка в любую точку России;
- Техническая поддержка проекта, помощь в подборе аналогов, поставка прототипов;
- Система менеджмента качества сертифицирована по Международному стандарту ISO 9001;
- Лицензия ФСБ на осуществление работ с использованием сведений, составляющих государственную тайну;
- Поставка специализированных компонентов (Xilinx, Altera, Analog Devices, Intersil, Interpoint, Microsemi, Aeroflex, Peregrine, Syfer, Eurofarad, Texas Instrument, Miteq, Cobham, E2V, MA-COM, Hittite, Mini-Circuits, General Dynamics и др.);

Помимо этого, одним из направлений компании «ЭлектроПласт» является направление «Источники питания». Мы предлагаем Вам помощь Конструкторского отдела:

- Подбор оптимального решения, техническое обоснование при выборе компонента;
- Подбор аналогов;
- Консультации по применению компонента;
- Поставка образцов и прототипов;
- Техническая поддержка проекта;
- Защита от снятия компонента с производства.



#### Как с нами связаться

**Телефон:** 8 (812) 309 58 32 (многоканальный)

**Факс:** 8 (812) 320-02-42

**Электронная почта:** [org@eplast1.ru](mailto:org@eplast1.ru)

**Адрес:** 198099, г. Санкт-Петербург, ул. Калинина, дом 2, корпус 4, литера А.