

ZXTN19020DFF

20V, SOT23F, NPN high gain power transistor

Summary

$BV_{CEX} > 70V$

$BV_{CEO} > 20V$

$BV_{ECO} > 4.5V$

$I_{C(cont)} = 6.5A$

$V_{CE(sat)} = < 30mV @ 1A$

$R_{CE(sat)} = 18m\Omega$

$P_D = 1.5W$

Complementary part number ZXTP19020DFF

Description

Advanced process capability has been used to maximize the performance of this transistor. The SOT23F package is compatible with the industry standard SOT23 footprint but offers lower profile and higher dissipation for applications where power density is of utmost importance.

Features

- Very low saturation voltage
- High gain
- High forward blocking voltage
- Low profile high dissipation package

Applications

- MOSFET and IGBT gate driving
- LED driving
- Strobe flash
- Motor drive
- Micro buffers

Ordering information

| Device | Reel size (inches) | Tape width (mm) | Quantity per reel |
|----------------|--------------------|-----------------|-------------------|
| ZXTN19020DFFTA | 7 | 8 | 3000 |

Device marking

1E3

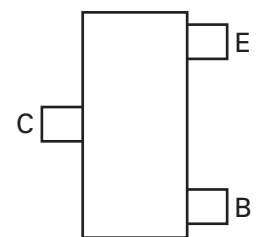
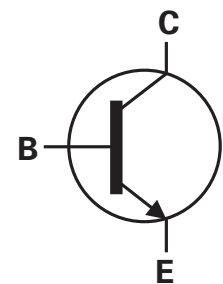

Pinout - top view

ZXTN19020DFF

Absolute maximum ratings

| Parameter | Symbol | Limit | Unit |
|--|----------------|-------------|-------|
| Collector-base voltage | V_{CBO} | 70 | V |
| Collector-emitter voltage (forward blocking) | V_{CEX} | 70 | V |
| Collector-emitter voltage (base open) | V_{CEO} | 20 | V |
| Emitter-collector voltage (reverse blocking) | V_{ECO} | 4.5 | V |
| Emitter-base voltage | V_{EBO} | 7 | V |
| Continuous collector current ^(c) | I_C | 6.5 | A |
| Base current | I_B | 1 | A |
| Peak pulse current | I_{CM} | 20 | A |
| Power dissipation at $T_{amb} = 25^{\circ}C^{(a)}$ | P_D | 0.84 | W |
| Linear derating factor | | 6.72 | mW/°C |
| Power dissipation at $T_{amb} = 25^{\circ}C^{(b)}$ | P_D | 1.34 | W |
| Linear derating factor | | 10.72 | mW/°C |
| Power dissipation at $T_{amb} = 25^{\circ}C^{(c)}$ | P_D | 1.5 | W |
| Linear derating factor | | 12.0 | mW/°C |
| Power dissipation at $T_{amb} = 25^{\circ}C^{(d)}$ | P_D | 2.0 | W |
| Linear derating factor | | 16.0 | mW/°C |
| Operating and storage temperature range | T_j, T_{stg} | - 55 to 150 | °C |

Thermal resistance

| Parameter | Symbol | Value | Unit |
|------------------------------------|-----------------|-------|------|
| Junction to ambient ^(a) | $R_{\theta JA}$ | 149.3 | °C/W |
| Junction to ambient ^(b) | $R_{\theta JA}$ | 93.4 | °C/W |
| Junction to ambient ^(c) | $R_{\theta JA}$ | 83.3 | °C/W |
| Junction to ambient ^(d) | $R_{\theta JA}$ | 60 | °C/W |

NOTES:

- (a) For a device surface mounted on 15mm x 15mm x 1.6mm FR4 PCB with high coverage of single sided 1oz copper, in still air conditions.
- (b) Mounted on 25mm x 25mm x 1.6mm FR4 PCB with a high coverage of single sided 2 oz copper in still air conditions.
- (c) Mounted on 50mm x 50mm x 1.6mm FR4 PCB with a high coverage of single sided 2 oz copper in still air conditions.
- (d) As (c) above measured at $t < 5$ secs.

Characteristics

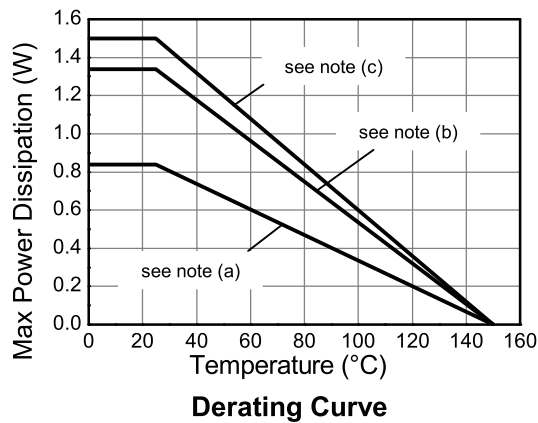
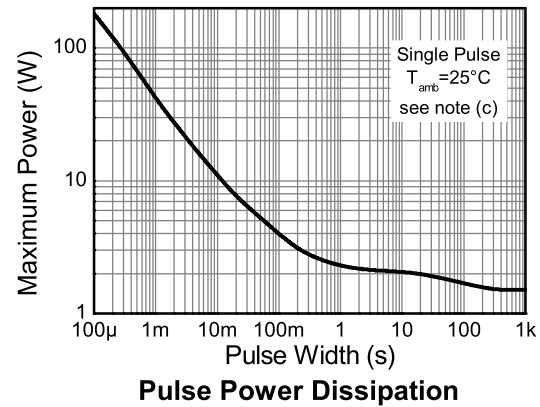
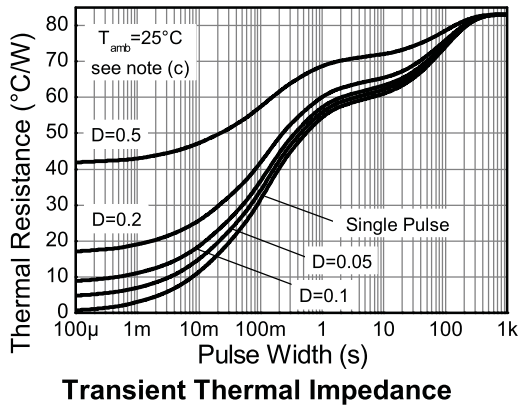
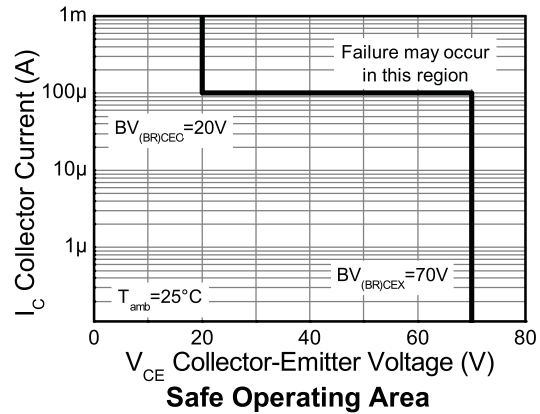
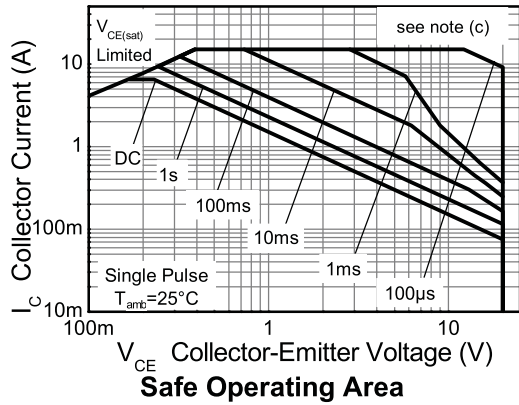

ZXTN19020DFF

Electrical characteristics (at $T_{amb} = 25^{\circ}\text{C}$ unless otherwise stated)

| Parameter | Symbol | Min. | Typ. | Max. | Unit | Conditions |
|--|---------------|-------------------------|-----------------------------|-----------------------------|----------------------------|---|
| Collector-base breakdown voltage | BV_{CBO} | 70 | 100 | | V | $I_C = 100\mu\text{A}$ |
| Collector-emitter breakdown voltage (forward blocking) | BV_{CEX} | 70 | 100 | | V | $I_C = 100\mu\text{A}$, $R_{BE} \leq 1\text{k}\Omega$ or $-1\text{V} < V_{BE} < 0.25\text{V}$ |
| Collector-emitter breakdown voltage (base open) | BV_{CEO} | 20 | 30 | | V | $I_C = 10\text{mA}^{(*)}$ |
| Emitter-base breakdown voltage | BV_{EBO} | 7 | 8.4 | | V | $I_E = 100\mu\text{A}$ |
| Emitter-collector breakdown voltage (reverse blocking) | BV_{ECX} | 6 | 8.4 | | V | $I_E = 100\mu\text{A}$, $R_{BC} \leq 1\text{k}\Omega$ or $0.25\text{V} > V_{BC} > -0.25\text{V}$ |
| Emitter-collector breakdown voltage (base open) | BV_{ECO} | 4.5 | 5.7 | | V | $I_E = 100\mu\text{A}$, |
| Collector-base cut-off current | I_{CBO} | | <1 | 50 20 | nA μA | $V_{CB} = 56\text{V}$ $V_{CB} = 56\text{V}$, $T_{amb} = 100^{\circ}\text{C}$ |
| Collector-emitter cut-off current | I_{CEX} | | - | 100 | nA | $V_{CE} = 56\text{V}$, $R_{BE} \leq 1\text{k}\Omega$ or $-1\text{V} < V_{BE} < 0.25\text{V}$ |
| Emitter-base cut-off current | I_{EBO} | | <1 | 50 | nA | $V_{EB} = 5.6\text{V}$ |
| Collector-emitter saturation voltage | $V_{CE(sat)}$ | | 25 45 70 55 140 | 30 65 95 75 190 | mV mV mV mV mV | $I_C = 1\text{A}$, $I_B = 100\text{mA}^{(*)}$ $I_C = 1\text{A}$, $I_B = 10\text{mA}^{(*)}$ $I_C = 2\text{A}$, $I_B = 20\text{mA}^{(*)}$ $I_C = 2\text{A}$, $I_B = 40\text{mA}^{(*)}$ $I_C = 6.5\text{A}$, $I_B = 180\text{mA}^{(*)}$ |
| Base-emitter saturation voltage | $V_{BE(sat)}$ | | 940 | 1050 | mV | $I_C = 6.5\text{A}$, $I_B = 180\text{mA}^{(*)}$ |
| Base-emitter turn-on voltage | $V_{BE(on)}$ | | 830 | 950 | mV | $I_C = 6.5\text{A}$, $V_{CE} = 2\text{V}^{(*)}$ |
| Static forward current transfer ratio | h_{FE} | 300 260 160 50 | 450 420 270 80 | 900 | | $I_C = 0.1\text{A}$, $V_{CE} = 2\text{V}^{(*)}$ $I_C = 2\text{A}$, $V_{CE} = 2\text{V}^{(*)}$ $I_C = 6.5\text{A}$, $V_{CE} = 2\text{V}^{(*)}$ $I_C = 15\text{A}$, $V_{CE} = 2\text{V}^{(*)}$ |
| Transition frequency | f_T | | 160 | | MHz | $I_C = 50\text{mA}$, $V_{CE} = 10\text{V}$ $f = 50\text{MHz}$ |
| Input capacitance | C_{ibo} | | 297 | | pF | $V_{EB} = 0.5\text{V}$, $f = 1\text{MHz}^{(*)}$ |
| Output capacitance | C_{obo} | | 32.6 | 40 | pF | $V_{CB} = 10\text{V}$, $f = 1\text{MHz}^{(*)}$ |
| Delay time | t_d | | 129 | | ns | $V_{CC} = 10\text{V}$. |
| Rise time | t_r | | 96 | | ns | $I_C = 1\text{A}$, |
| Storage time | t_s | | 398 | | ns | $I_{B1} = -I_{B2} = 10\text{mA}$. |
| Fall time | t_f | | 90 | | ns | |

NOTES:

(*) Measured under pulsed conditions. Pulse width $\leq 300\mu\text{s}$; duty cycle $\leq 2\%$.

Typical characteristics

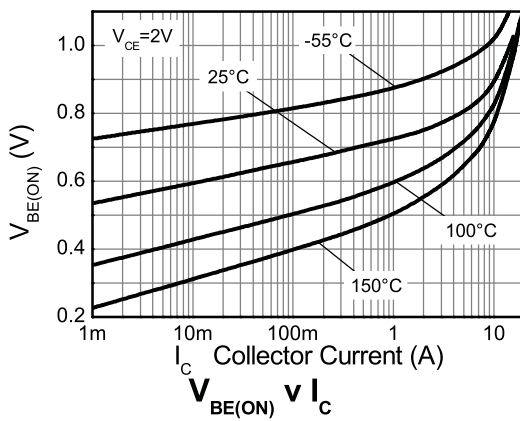
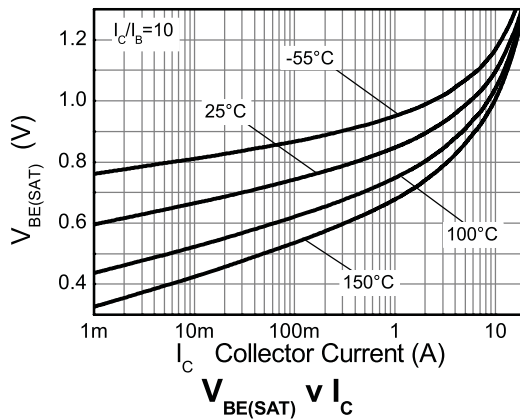
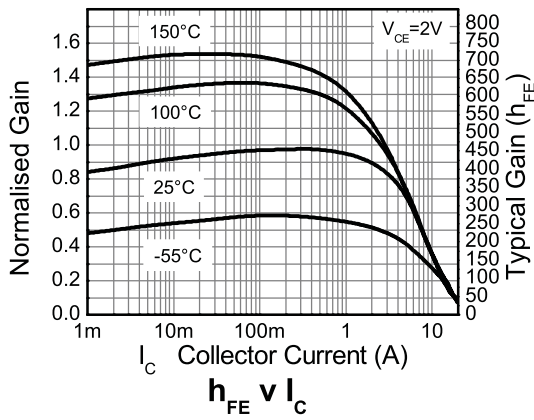
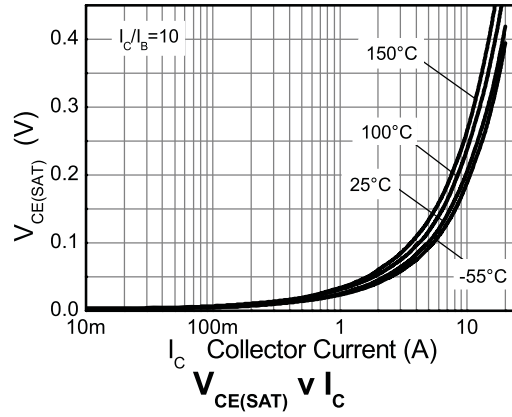
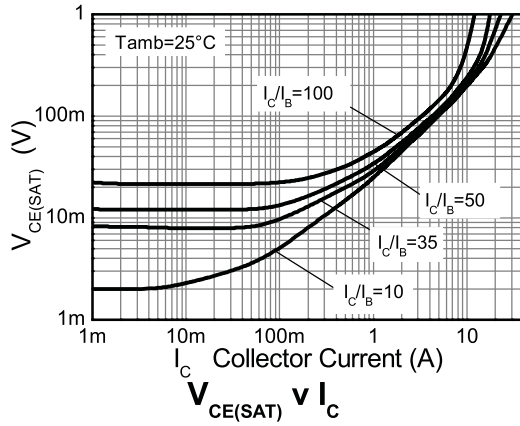

Intentionally left blank

ZXTN19020DFF

Package outline - SOT23F

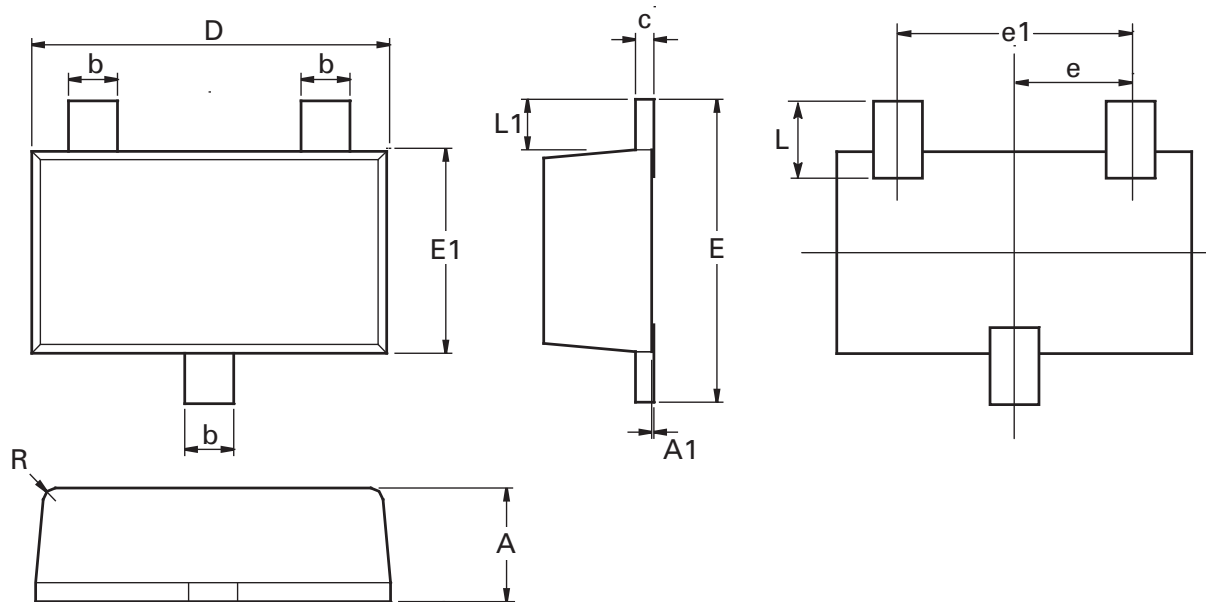

| Dim. | Millimeters | | Inches | | Dim. | Millimeters | | Inches | |
|------|-------------|------|------------|--------|------|-------------|------|--------|--------|
| | Min. | Max. | Min. | Max. | | Min. | Max. | Max. | Max. |
| A | 0.80 | 1.00 | 0.0315 | 0.0394 | E | 2.30 | 2.50 | 0.0906 | 0.0984 |
| A1 | 0.00 | 0.10 | 0.00 | 0.0043 | E1 | 1.50 | 1.70 | 0.0590 | 0.0669 |
| b | 0.35 | 0.45 | 0.0153 | 0.0161 | E2 | 1.10 | 1.26 | 0.0433 | 0.0496 |
| c | 0.10 | 0.20 | 0.0043 | 0.0079 | L | 0.48 | 0.68 | 0.0189 | 0.0268 |
| D | 2.80 | 3.00 | 0.1102 | 0.1181 | L1 | 0.30 | 0.50 | 0.0153 | 0.0161 |
| e | 0.95 ref | | 0.0374 ref | | R | 0.05 | 0.15 | 0.0019 | 0.0059 |
| e1 | 1.80 | 2.00 | 0.0709 | 0.0787 | O | 0° | 12° | 0° | 12° |

Note: Controlling dimensions are in millimeters. Approximate dimensions are provided in inches

Definitions

Product change

Zetex Semiconductors reserves the right to alter, without notice, specifications, design, price or conditions of supply of any product or service. Customers are solely responsible for obtaining the latest relevant information before placing orders.

Applications disclaimer

The circuits in this design/application note are offered as design ideas. It is the responsibility of the user to ensure that the circuit is fit for the user's application and meets with the user's requirements. No representation or warranty is given and no liability whatsoever is assumed by Zetex with respect to the accuracy or use of such information, or infringement of patents or other intellectual property rights arising from such use or otherwise. Zetex does not assume any legal responsibility or will not be held legally liable (whether in contract, tort (including negligence), breach of statutory duty, restriction or otherwise) for any damages, loss of profit, business, contract, opportunity or consequential loss in the use of these circuit applications, under any circumstances.

Life support

Zetex products are specifically not authorized for use as critical components in life support devices or systems without the express written approval of the Chief Executive Officer of Zetex Semiconductors plc. As used herein:

A. Life support devices or systems are devices or systems which:

1. are intended to implant into the body

or

2. support or sustain life and whose failure to perform when properly used in accordance with instructions for use provided in the labeling can be reasonably expected to result in significant injury to the user.

B. A critical component is any component in a life support device or system whose failure to perform can be reasonably expected to cause the failure of the life support device or to affect its safety or effectiveness.

Reproduction

The product specifications contained in this publication are issued to provide outline information only which (unless agreed by the company in writing) may not be used, applied or reproduced for any purpose or form part of any order or contract or be regarded as a representation relating to the products or services concerned.

Terms and Conditions

All products are sold subjects to Zetex' terms and conditions of sale, and this disclaimer (save in the event of a conflict between the two when the terms of the contract shall prevail) according to region, supplied at the time of order acknowledgement.

For the latest information on technology, delivery terms and conditions and prices, please contact your nearest Zetex sales office.

Quality of product

Zetex is an ISO 9001 and TS16949 certified semiconductor manufacturer.

To ensure quality of service and products we strongly advise the purchase of parts directly from Zetex Semiconductors or one of our regionally authorized distributors. For a complete listing of authorized distributors please visit: www.zetex.com/salesnetwork

Zetex Semiconductors does not warrant or accept any liability whatsoever in respect of any parts purchased through unauthorized sales channels.

ESD (Electrostatic discharge)

Semiconductor devices are susceptible to damage by ESD. Suitable precautions should be taken when handling and transporting devices. The possible damage to devices depends on the circumstances of the handling and transporting, and the nature of the device. The extent of damage can vary from immediate functional or parametric malfunction to degradation of function or performance in use over time. Devices suspected of being affected should be replaced.

Green compliance

Zetex Semiconductors is committed to environmental excellence in all aspects of its operations which includes meeting or exceeding regulatory requirements with respect to the use of hazardous substances. Numerous successful programs have been implemented to reduce the use of hazardous substances and/or emissions.

All Zetex components are compliant with the RoHS directive, and through this it is supporting its customers in their compliance with WEEE and ELV directives.

Product status key:

| | |
|-----------------------------------|--|
| "Preview" | Future device intended for production at some point. Samples may be available |
| "Active" | Product status recommended for new designs |
| "Last time buy (LTB)" | Device will be discontinued and last time buy period and delivery is in effect |
| "Not recommended for new designs" | Device is still in production to support existing designs and production |
| "Obsolete" | Production has been discontinued |

Datasheet status key:

| | |
|-----------------------|---|
| "Draft version" | This term denotes a very early datasheet version and contains highly provisional information, which may change in any manner without notice. |
| "Provisional version" | This term denotes a pre-release datasheet. It provides a clear indication of anticipated performance. However, changes to the test conditions and specifications may occur, at any time and without notice. |
| "Issue" | This term denotes an issued datasheet containing finalized specifications. However, changes to specifications may occur, at any time and without notice. |

Zetex sales offices

| Europe | Americas | Asia Pacific | Corporate Headquarters |
|--|---|--|--|
| Zetex GmbH Kustermann-park Balanstraße 59 D-81541 München Germany Telephone: (49) 89 45 49 49 0 Fax: (49) 89 45 49 49 49 europe.sales@zetex.com | Zetex Inc 700 Veterans Memorial Highway Hauppauge, NY 11788 USA Telephone: (1) 631 360 2222 Fax: (1) 631 360 8222 usa.sales@zetex.com | Zetex (Asia Ltd) 3701-04 Metroplaza Tower 1 Hing Fong Road, Kwai Fong Hong Kong Telephone: (852) 26100 611 Fax: (852) 24250 494 asia.sales@zetex.com | Zetex Semiconductors plc Zetex Technology Park, Chadderton Oldham, OL9 9LL United Kingdom Telephone: (44) 161 622 4444 Fax: (44) 161 622 4446 hq@zetex.com |

© 2007 Published by Zetex Semiconductors plc



Компания «ЭлектроПласт» предлагает заключение долгосрочных отношений при поставках импортных электронных компонентов на взаимовыгодных условиях!

Наши преимущества:

- Оперативные поставки широкого спектра электронных компонентов отечественного и импортного производства напрямую от производителей и с крупнейших мировых складов;
- Поставка более 17-ти миллионов наименований электронных компонентов;
- Поставка сложных, дефицитных, либо снятых с производства позиций;
- Оперативные сроки поставки под заказ (от 5 рабочих дней);
- Экспресс доставка в любую точку России;
- Техническая поддержка проекта, помощь в подборе аналогов, поставка прототипов;
- Система менеджмента качества сертифицирована по Международному стандарту ISO 9001;
- Лицензия ФСБ на осуществление работ с использованием сведений, составляющих государственную тайну;
- Поставка специализированных компонентов (Xilinx, Altera, Analog Devices, Intersil, Interpoint, Microsemi, Aeroflex, Peregrine, Syfer, Eurofarad, Texas Instrument, Miteq, Cobham, E2V, MA-COM, Hittite, Mini-Circuits, General Dynamics и др.);

Помимо этого, одним из направлений компании «ЭлектроПласт» является направление «Источники питания». Мы предлагаем Вам помощь Конструкторского отдела:

- Подбор оптимального решения, техническое обоснование при выборе компонента;
- Подбор аналогов;
- Консультации по применению компонента;
- Поставка образцов и прототипов;
- Техническая поддержка проекта;
- Защита от снятия компонента с производства.



Как с нами связаться

Телефон: 8 (812) 309 58 32 (многоканальный)

Факс: 8 (812) 320-02-42

Электронная почта: org@eplast1.ru

Адрес: 198099, г. Санкт-Петербург, ул. Калинина, дом 2, корпус 4, литера А.