

Powerpole® Connectors

- PP15 to PP45 :

up to 55 Amps

PP15-45 series are the smallest Powerpole® housings. They can be used for wire-to-wire or wire-to-board applications. Wire sizes from #20 AWG (0.75 mm²) to #10 (6 mm²) offer power capabilities up to 55 amps per pole. Finger proof housings and the ability to incorporate first-mate last-break ground connectors enhance the capabilities of this Powerpole® series.

High Power Density

- Up to 55 amps in a compact footprint

Wire-to Wire & Wire-to-Board Configurations

- Wire & PCB contacts can be used in the same housings

Finger Proof Housings Available

- Protects against accidental contact with live circuits

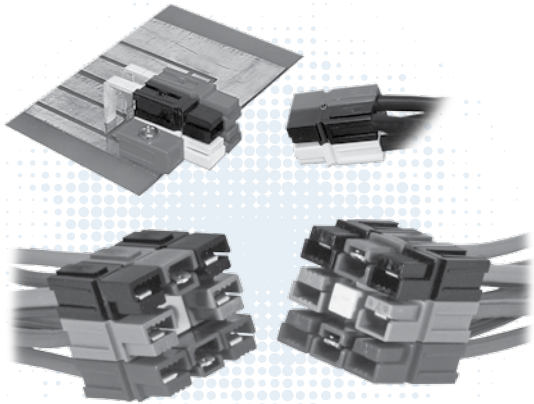

SECTION 2
Powerpole® PP15 to 45

PP15-45 ORDERING INFORMATION

PP15-45 Finger Proof Housings

Improved on the original APP® design by adding ribs to mating interface to protect against accidental contact with live circuits. Meets the requirements of UL1977 section 10.2 and is rated IP20. Will not mate with standard housings.

Description	Part Numbers	
Minimum Quantity ...	2,500	200
Red	1327FP-BK	1327FP
Green	1327G5FP-BK	1327G5FP
Black	1327G6FP-BK	1327G6FP
White	1327G7FP-BK	1327G7FP
Blue	1327G8FP-BK	1327G8FP
Yellow	1327G16FP-BK	1327G16FP

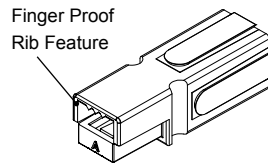

PP15-45 Finger Proof & Standard & Ground Housing Dimensions

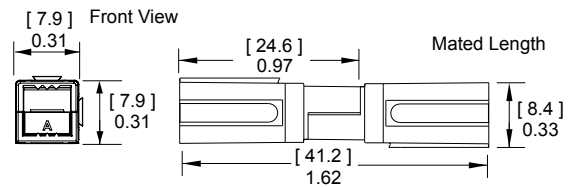

PP15-45 Standard Housings

The original housing design has an open interface and is available in a wide array of colors. Will not mate with finger proof housings.

Description	Part Numbers	
Minimum Quantity ...	2,500	200
Red	1327-BK	1327
Green	1327G5-BK	1327G5
Black	1327G6-BK	1327G6
White	1327G7-BK	1327G7
Blue	1327G8-BK	1327G8
Yellow	1327G16-BK	1327G16
Orange	1327G17-BK	1327G17
Gray	1327G18-BK	1327G18
Brown	1327G21-BK	1327G21
Pink	1327G22-BK	1327G22
Purple	1327G23-BK	1327G23

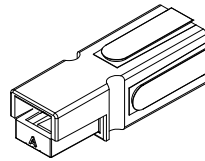

45A Premate Ground Housings

Green housings are keyed to prevent accidental mating with standard or finger proof Powerpole® housings.

Description	Part Number	
Minimum Quantity ...	2,500	200
Green	1827G1-BK	1827G1

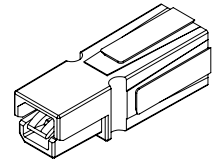

PP15-45 Tin Plated Power Contacts

Offer cost effective performance up to 1,500 mating cycles. See specifications and temperature charts for amperage ratings by wire size.

Barrel	AWG	mm ²	Mating Force	Loose Piece Part Numbers	Reeled Part Numbers	Dimensions - A -	
						inches	mm
Minimum Quantity				200	5,000		
Open	14 to 10 K*	2.1 to 5.3	High	269G3-LPBK	269G3	0.21	5.33
Open	14 to 10 K*	2.1 to 5.3	Low	261G2-LPBK	261G2	0.20	5.08
Open	14 to 10 SF*	2.1 to 6.0	High	201G1H-LPBK	201G1H	0.24	6.10
Open	14 to 10 SF*	2.1 to 6.0	Low	200G1L-LPBK	200G1L	0.24	6.10
Open	16 to 12	1.3 to 3.3	High	269G1-LPBK	269G1	0.18	4.57
Open	16 to 12	1.3 to 3.3	Low	261G1-LPBK	261G1	0.18	4.57
Open	20 to 16	0.52 to 1.3	High	269G2-LPBK	269G2	0.16	4.06
Open	20 to 16	0.52 to 1.3	Low	262G1-LPBK	262G1	0.16	4.06
Open	20 to 16 SF*	0.52 to 1.5	Low	200G2L-LPBK	200G2L	0.20	5.08

Open Barrel Contact

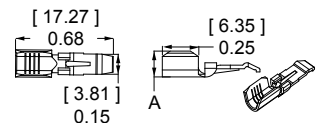

K* - For #10 AWG class K stranded wire or smaller. For larger wires use superflex contacts.
SF*- Indicates wires with high stranding such as Super Flex.

PP15-45 Silver Plated Power Contacts

Maximize performance by offering up to 10,000 mating cycles and are recommended for circuit interrupt or hot plug applications. See specifications and temperature charts for amperage ratings by wire size. Only closed barrel contacts are suitable for soldering.

Barrel	AWG	mm ²	Mating Force	Loose Piece		Reeled Part Number	Dimensions						
				Part Number	Part Number		- A -		- B -				
Minimum Quantity				5,000	200	5,000							
Open	14 to 10 K*	2.1 to 5.3	Low	-	261G3-LPBK	261G3	0.20	5.08	-	-			
Open	14 to 10 SF*	2.1 to 6.0	High	-	-	201G3H	0.24	6.10	-	-			
Open	14 to 10 SF*	2.1 to 6.0	Low	-	200G3L-LPBK	200G3L	0.24	6.10	-	-			
Open	16 to 12	1.3 to 3.3	Low	-	261G4-LPBK	261G4	0.18	4.57	-	-			
Open	20 to 16	0.52 to 1.3	Low	-	262G2-LPBK	262G2	0.16	4.06	-	-			
Open	20 to 16 SF*	0.52 to 1.5	Low	-	-	200G4L	0.20	5.08	-	-			
Closed	16 to 12	1.3 to 3.3	Low	1331-BK	1331	-	0.15	3.81	0.10	2.54			
Closed	20 to 16	0.52 to 1.3	Low	1332-BK	1332	-	0.12	3.05	0.07	1.78			

K* - For #10 AWG class K stranded wire or smaller. For larger wires use superflex contacts.

SF* - Indicates wires with high stranding such as Super Flex.

Open Barrel Contact

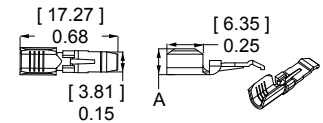

Closed Barrel Contact

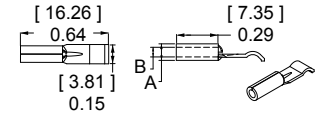

45A Premate Ground Wire Contacts

Tin or silver plated contacts are rated for ground or power. Hand tools are available for loose piece contacts. Reeled contacts can be used with high volume press and applicator tooling. Tin contacts are rated for up to 1,500 mating cycles. Silver contacts are rated up to 10,000 mating cycles.

Type	AWG	mm ²	Mating Force	Loose Piece Part Numbers	Reeled Part Numbers
Minimum Quantity				200	5,000
Open, Tin	14 to 10	2.1 to 6.0	Low	1830G1-LPBK	1830G1
Open, Silver	14 to 10	2.1 to 6.0	Low	1830G2-LPBK	1830G2

Open Barrel Premate Contact

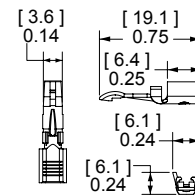

25A Right Angle PCB Contacts Tin Plated

Suitable for right angle applications up to 25A per pole. Tin plating enhances solderability. Cannot be mixed with 45A PCB contacts. For mating with wire contacts only.

Row	Mating Force	Loose Piece		Dimensions			
		Part Numbers	Part Numbers	- A -		- B -	
Minimum Quantity		1,000	100				
Top	Low	1377G1-BK	1377G1	0.59	14.80	1.52	38.60
	High	1317G1-BK	1317G1				
Bottom	Low	1377G2-BK	1377G2	0.29	7.20	1.36	34.50
	High	1317G2-BK	1317G2				
Top	Low	1377G11-BK	1377G11	0.59	14.80	1.21	30.70
	High	1317G11-BK	1317G11				
Bottom	Low	1377G12-BK	1377G12	0.29	7.20	1.01	25.70
	High	1317G12-BK	1317G12				

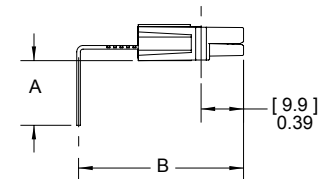
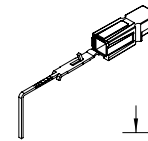

Use mounting staples with right angle contacts (see accessories).

See website for PCB layout drawing.

25A Vertical PCB Contacts Tin Plated

For mating with wire contacts only. Suitable for vertical applications up to 25A per pole, tin plating enhances solderability.

Mating Force	Loose Piece		Dimensions - A -	
	Part Numbers	Part Numbers	inches	mm
Minimum Quantity	1,000	100		
Low	1377G3-BK	1377G3	2.22	56.40
High	1317G3-BK	1317G3	2.22	56.40
Low	1377G4-BK	1377G4	1.76	44.70
High	1317G4-BK	1317G4	1.76	44.70
Low	1377G13-BK	1377G13	1.17	29.70
High	1317G13-BK	1317G13	1.17	29.70

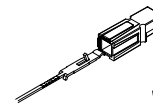

45A Right Angle and Vertical PCB Contacts Tin Plated

Suitable for right angle or vertical applications up to 45A per pole. Tin plating enhances solderability. Right angle contacts cannot be mixed with 25A PCB contacts. For mating with wire contacts only.

Description	Loose Piece	
	Part Numbers	Part Numbers
Minimum Quantity	1,000	100
Vertical	3-5911P1	1335G1
Right Angle Bottom Row	3-5912P1	1336G1
Right Angle Top Row	3-5913P1	1337G1

Vertical

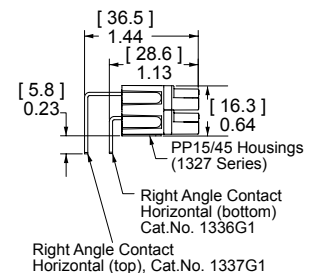
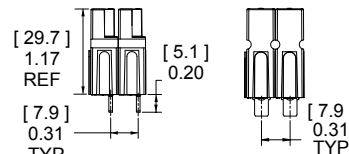

Use mounting staples with right angle contacts (see accessories).

45A Premate Ground PCB Contacts

Right angle contacts are suitable for power or ground. Use to mate with 45A ground wire contacts. Tin plated contacts are rated up to 1,500 mating cycles. Can be used with other 45A PCB connectors in the bottom row.

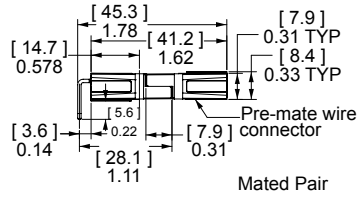

	Mating Force	Loose Piece	
		Part Numbers	
Minimum Quantity		1000	100
PCB, Bottom Row	Low	3-5952P1	1836G1

| PP15-45 ULTRASONICALLY BONDED ASSEMBLIES |

Assemblies feature housings that are ultrasonically welded to create a one piece connector unit using an APP® special process. After welding, retaining pins are no longer required to secure the stacked housings to each other. This allows Powerpole® 15-45 connectors to be used as a durable one piece connector header. Contact customer service for configurations not shown below.

Single Row 1x2 Assemblies

Circuit Description	Housings Only	Housings with 45A Vertical PCB Contacts	Housings with 45A Right Angle PCB Contacts	Color & Type Position Matrix	
Minimum Quantity	500	500	500	1	2
DC 2 Wire Standard Housings	ASMPP30-1X2-RK	ASMPV45-1X2-RK	ASMPR45-1X2-RK	RED / STD	BLK / STD
DC 2 Wire Reverse Standard Housings	ASMPP30-1X2-KR	ASMPV45-1X2-KR	ASMPR45-1X2-KR	BLK / STD	RED / STD
DC 2 Wire Finger Proof	ASMFP30-1X2-RK	ASMPV45-1X2-RK	ASMPR45-1X2-RK	RED / FP	BLK / FP
DC 2 Wire Finger Proof Reverse	ASMFP30-1X2-KR	ASMPV45-1X2-KR	ASMPR45-1X2-KR	BLK / FP	RED / FP

Single Row 1x3 Assemblies

Circuit Description	Housings Only	Housings with 45A Vertical PCB Contacts	Housings with 45A Right Angle PCB Contacts	Color & Type Position Matrix		
Minimum Quantity	500	500	500	1	2	3
DC 2 Wire Finger Proof with Ground	ASMFP30-1X3-KER	N/A	ASMPR45-1X3-KER	BLK / FP	GRN / GND	RED / FP
AC Single Phase Finger Proof	ASMFP30-1X3-KEW	ASMPV45-1X3-KEW	ASMPR45-1X3-KEW	BLK / FP	GRN / GND	WHT / FP

Two Row 2x1 Assemblies

Circuit Description	Housings Only	Housings with 45A Vertical PCB Contacts	Housings with 45A Right Angle PCB Contacts	Color & Type Position Matrix	
Minimum Quantity	500	500	500	1	2
DC 2 Wire Finger Proof	ASMFP30-2X1-KR	ASMPV45-2X1-KR	ASMPR45-2X1-KR	BLK / FP	RED / FP
DC 2 Wire Finger Proof Mate	ASMFP30-2X1-RK	ASMPV45-2X1-RK	ASMPR45-2X1-RK	RED / FP	BLK / FP

Two Row 2x2 Assemblies

Circuit Description	Housings Only	Housings with 45A Vertical PCB Contacts	Housings with 45A Right Angle PCB Contacts	Color & Type Position Matrix			
Minimum Quantity	500	500	500	1	2	3	4
AC 3 Phase, 3 Wire Finger Proof	ASMFP30-2X2-KRWE	N/A	N/A	BLK / FP	RED / FP	WHT / FP	GRN / GND
AC 3 Phase, 3 Wire Finger Proof Mate	ASMFP30-2X2-WEKR	N/A	ASMPR45-2X2-WEKR	WHT / FP	GRN / GND	BLK / FP	RED / FP



Single Row 1x2 Assembly



Single Row 1x3 Assembly

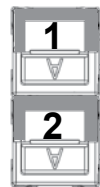

Two Row 2x1 Assembly

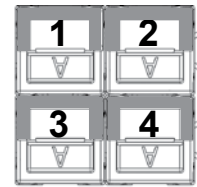

Two Row 2x2 Assembly

Type

STD = Standard Housing
FP = Finger Proof Housing
GND = Ground Housing

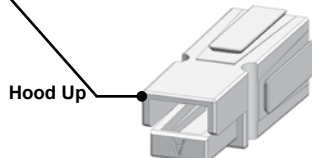

Powerpole® Pak Connectors - PP15 to PP45

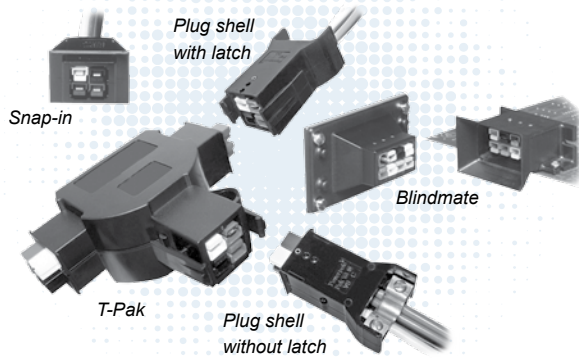

Powerpole® Pak connector shells enclose stacked groupings of PP15-45 sized housings in a durable black shell for a finished connector appearance and additional features. Inline, panel mount, and blindmate configurations are available. Plug shells offer the option of integral latches and strain relief to help secure your connection.

- **Package Groupings of PP15-45 Connectors**
Provides a finished appearance while protecting the individual connectors with an outer shell
- **Inline, Panel Mount, “T” or Blindmate Configurations**
Allows one connection system to meet multiple needs
- **Optional Latching and Strain Relief**
Secures your connection and wires

For environmentally sealed connector shells to hold Powerpole® 15-180 connectors, see APP®’s SPEC Pak® product series on our website, www.andersonpower.com



Powerpole® Pak ORDERING INFORMATION

Powerpole® housings and contacts are sold separately. See page 20 for ordering information.

Plug Shell without Latch

Can mate inline with other plug shells with or without latches, or mate to a panel mount receptacle. For use with Powerpole® wire connectors only. Cable Clamp and Hardware Pak or Retaining Pins must be ordered separately.

Description	Part Numbers			Dimensions - A -	
	1,000	500	25	inches	mm
Minimum Quantity	1,000	500	25		
Black, 2-4 Poles	1461G1-BK	-	1461G1	1.24	31.50
Black, 5-6 Poles	-	1461G2-BK	1461G2	1.56	39.62
Black, 7-8 Poles	-	1461G3-BK	1461G3	1.87	47.50

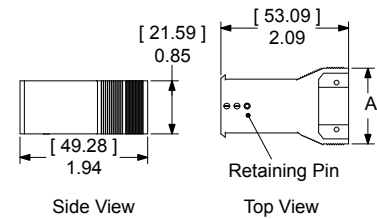

NOTE: Retaining pins are used to secure and position Powerpoles® in one of three positions in plug shells.

Max wire O.D. for 2-4 pole plug shells is 0.60 inches [15.2mm²].
For all other plug shells is 0.63 inches [16.0 mm²].

Plug Shell with Latch

Can mate inline with other plug shells without latches, or mate to a panel mount receptacle. For use with Powerpole® wire connectors only. Cable Clamp and Hardware Pak or Retaining Pins must be ordered separately.

Description	Part Numbers			Dimensions					
	1,000	500	25	- B -		- C -		- D -	
				inches	mm	inches	mm	inches	mm
Minimum Quantity	1,000	500	25						
Black, 2-4 Poles	1460G1-BK	-	1460G1	1.94	49.28	2.25	57.15	1.24	31.50
Black, 5-6 Poles	-	1460G2-BK	1460G2	1.94	49.28	2.25	57.15	1.56	39.62
Black, 7-8 Poles	-	1460G3-BK	1460G3	1.94	49.28	2.25	57.15	1.87	47.50
Black, 9-10 Poles	-	1460G4-BK	1460G4	2.51	63.75	2.82	71.63	1.84	46.74

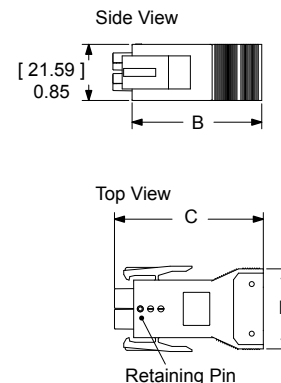



Plug Shell with Latch & Non-Conductive Strain Relief

New 2X3 Powerpole Pak offers an improved ergonomic shell for easier latch operation as well as a plastic, non-conductive strain relief. The new strain relief can accommodate up to a 6 conductor #10 AWG cable. Can mate to a panel mount receptacle. For use with Powerpole® wire connectors only. Cable Clamp and Hardware Pak or Retaining Pins must be ordered separately. To be used with 115G23 cable clamp only.

Description	----- Part Numbers -----		
Minimum Quantity	1,000	25	...
Black, 5-6 Poles	1460G23-BK	1460G23	

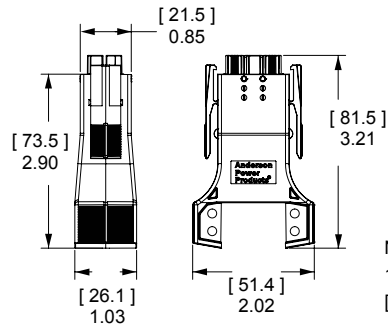

NOTE: Max wire O.D. for 1460G23 is 0.80 inches [20.3 mm²].

Snap-in Receptacle Shell

Mate to plug shells with or without latches, or mate to another panel mount receptacle to create a bulkhead to bulkhead connection. For use with Powerpole® wire or PCB connectors. Order the number of retaining pins for each receptacle as shown below separately.

Description	----- Part Numbers -----			Number of Retaining Pins to Order	Dimensions - E -		Knock Out Size - Width -	
	1,000	500	25		inches	mm	inches	mm
Black, 2-4 Poles	1470G1-BK	-	1470G1	1	1.50	38.10	1.25	31.75
Black, 5-6 Poles	-	1470G2-BK	1470G2	2	1.88	47.75	1.62	41.15
Black, 7-8 Poles	-	1470G3-BK	1470G3	3	2.13	54.10	1.88	47.75
Black, 9-10 Poles	-	1470G4-BK	1470G4	4	2.44	61.98	2.19	55.63

* Height = [25.4 mm] 1.0 in.

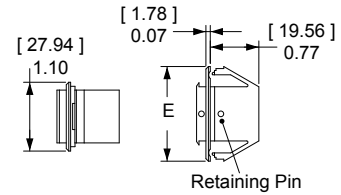

NOTE: Retaining pins are used to secure and position Powerpoles® in one of two positions in receptacle shells.

Cable Clamp & Hardware Pak

Includes cable clamp, 2 screws, and required amount of retaining pins for each configuration.

Description	Screw Head Type	Cable Type	----- Part Numbers -----		
Minimum Quantity			1,000	500	25 ...
2-4 Poles	Straight Slot	Bundled	115G1-BK	-	115G1
5-6 Poles	Straight Slot	Bundled	115G2-BK	-	115G2
7-8 Poles	Straight Slot	Bundled	115G3-BK	-	115G3
9-10 Poles	Straight Slot	Bundled	-	115G4-BK	115G4
2-4 Poles	Philips	Bundled	115G7-BK	-	115G7
5-6 Poles	Philips	Bundled	115G8-BK	-	115G8

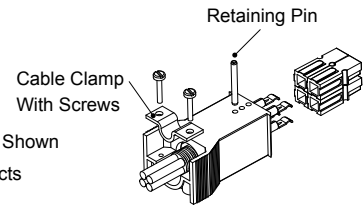

Plug Shell Without Latch Shown
Shell, housing and contacts are sold separately.



Cable Clamp & Hardware Pak

Includes 2 cable clamp halves, 2 screws and 2 retaining pins. To be used with 1460G23 Plug Shell only.

Description	Screw Head Type	Cable Type	----- Part Numbers -----	
Minimum Quantity			1,000	25
5-6 Poles	Philips	Bundled	115G23-BK	115G23

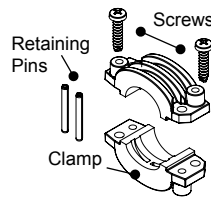

Flexible Conduit Clamp & Hardware Pak

Includes cable clamp, 2 screws, and need amount of retaining pins for each configuration.

Description	- Part Number -
Minimum Quantity 100
2-4 Poles	110G10

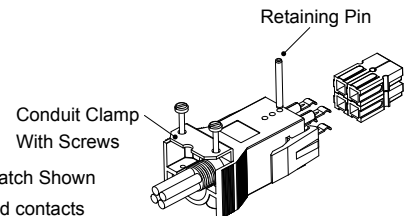

Plug Shell With Latch Shown
Shell, housing and contacts are sold separately.

Retaining Pin for Snap-in Receptacle

Order the number of retaining pins for each receptacle shown in the Snap-in Receptacle Shell ordering information. Pins are also required for the plug side when the Cable Clamp & Hardware Pak is not ordered.

Description	----- Part Number -----	
Minimum Quantity 1,000	100 ...
Retaining Pin	110G9-BK	110G9

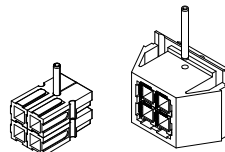

Shell and housing are sold separately.

Blindmate Pak Connector

Ideal for panel to panel, bulkhead to bulkhead, or rack mount applications that require the power connector to compensate for up to 0.45 in. [11.43 mm] of misalignment in either axis. Eight positions can be filled with Powerpole® 10-45 connectors. The receptacle side can be used with wire or PCB contacts. Hardware bag includes retaining pins.

Description	----- Part Numbers -----	
Minimum Quantity	50	25
2x4 Blindmate Plug Shell, Hardware & Pins	-	BMPP10-45P
2x4 Blindmate Receptacle Shell, Hardware & Pins	-	BMPP10-45R
2x4 Blindmate Plug Shell	BMHSG-P	-
2x4 Blindmate Receptacle Shell	BMHSG-R	-
Hardware Bag Plug Side	-	110G50
Hardware Bag Receptacle Side	-	110G51

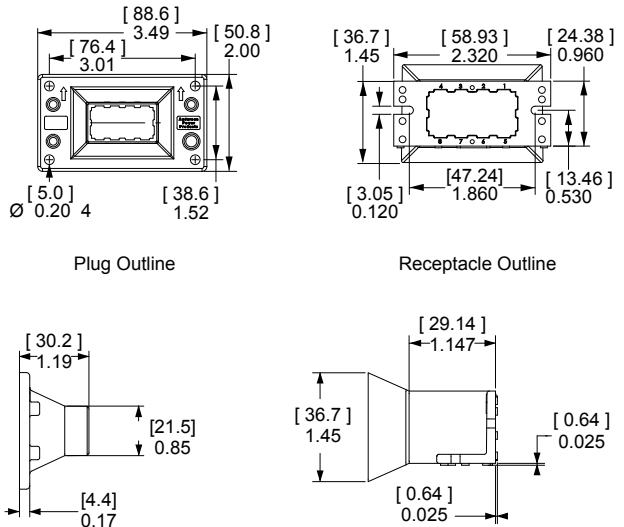

See APP's innovative MARC Connector that offers straight-on or rotational blindmate capability. MARC holds 6 PP15/45 power contacts and 2 PP15/45 premate ground contacts in a high temperature housing. Visit our website, www.andersonpower.com to learn more.



"T" Pak 2 Way Splitter

The Powerpole® "T" Pak connector is a 2 way electrical splitter that splits electrical current from one incoming circuit into two outgoing circuits. The standard configuration is pre-wired for AC 3 phase, 3 wire plus ground configurations. The "T" Pak can also be used for AC single phase plus ground or DC 2 wire plus ground applications by not using either the red or white power positions. "T" Pak is pre-wired from the factory allowing plug and play field installation of modular office and industrial equipment. UL recognition up to 20 amps and 600 volts is achieved when mating Powerpole® Pak plugs are used with #12 AWG wire.

For OEM manufacturing scale applications, the "T" Pak can be loaded with custom configurations of any of APP's finger proof, standard, or ground housings and contacts in the PP15-45 series. Contact APP's sales or customer service for additional information.

Description	- Part Numbers -
Minimum Quantity	80
Assembled "T" Pak	20-01
Mating Plug Shell with Latch 2x2	26-01
Mating Plug Shell without Latch 2x2	27-01

Standard configuration for each side of the T includes (1) each Red, Black, and White Standard PP 15-45 Housings & 261G2-LPBK contacts with (1) 45A Green Premate Ground Housing and 1830G1-LPBK contact.

Mating plug shells include (1) each Red, Black, and White Standard PP 15-45 Housings & (3) 261G2-LPBK contacts with (1) 45A Green Premate Ground Housing and 1830G1-LPBK contact. Cable clamp & hardware pak also included.

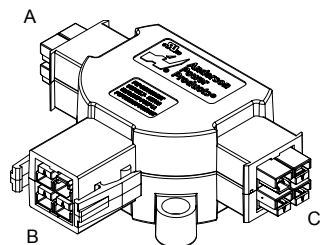
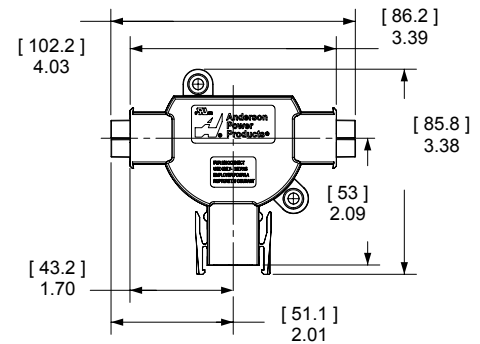

PP15-45 & POWERPOLE® PAK SPECIFICATIONS |

SECTION 2
Powerpole® PP15 to 45

Electrical		
Current Rating Amperes¹	UL 1977	CSA/TUV
Singlepole Wire to Wire (10 AWG)	55	40
Singlepole Ground Wire to Wire or PCB (10 AWG)	45	35
3x3 Block Wire to Wire (10 AWG)	40	27
Singlepole 25A PCB to Wire (12 AWG)	25	-
2x3 Block 25A PCB to Wire (12 AWG)	25	22 *
Singlepole 45A PCB to Wire (10 AWG)	45	40 *
2x3 Block 45A PCB to Wire (10 AWG)	45	25 *
Voltage Rating AC/DC		
UL 1977	600	
PCB Connector Recommended Voltage³		
per IEC 60950-1 Table 2L Pollution Degree²		
25A Contacts Adjacent Poles	495	
25A Contacts Separated by Spacer	1,000	
45A Contacts Adjacent Poles	160	
45A Contacts Separated by Spacer	970	
Dielectric Withstanding Voltage		
Volts AC	2,200	
Avg. Mated Contact Resistance Milliohms¹		
15A Wire Contact with 5/8" of #16 AWG	0.875	
30A Wire Contact with 5/8" of #12 AWG	0.600	
45A Wire Contact with 5/8" of #10 AWG	0.525	
45A PCB Contact to Contact	0.500	
25A PCB Contact to Contact	0.600	
UL Hot Plug Current Rating Amperes		
250 cycles at 72V DC	45A	
250 cycles at 120V DC	30A	
UL Ground Short Time Current Test - 45A Premate Ground		
750 Amps, #10 AWG Wire	4 Seconds	
470 Amps, #12 AWG Wire	4 Seconds	

Materials	
Housing	
Plastic Resin	Polycarbonate
Contact Retention Spring	Stainless Steel
Housing Flammability Rating	
UL94	V-0
Contact	
Base	Copper Alloy
Plating	Tin or Silver
Contact Termination Methods	
Crimp ³	Wire Contacts
Hand Solder	1331, 1332 & PCB Contacts
Solder Dip	PCB Contacts
Wave Solder	PCB Contacts

Mechanical		
Wire Size Range	AWG	mm²
	20 to 10	0.75 to 6.0
Max. Wire Insulation Diameter	in.	mm
	0.175	4.450
Operating Temperature²	°F	°C
Powerpole® Housings & Powerpole® Pak Shells	-4° to 221°	-20° to 105°
Mating Cycles No Load by Plating	Silver (Ag)	Tin (Sn)
PCB to Wire	-	1,500
Wire to Wire	10,000	1,500
Avg. Mating / Unmating Force	Lbf.	N
Low Force Wire, High Force PCB, & Ground	3	13
High Force Wire	5	22
Low Force PCB	2	9
Min. Contact / Spring Retention Force	Lbf.	N
	20	90
Powerpole® Pak Latch Avg. Defeat Force	Lbf.	N
	150	667
PCB Specifications		
Mounting Style	Plated Through Hole	
PCB Thickness- in. [mm]	0.090 - 0.150	(2.3-3.8)
25A PCB Recommended Traces	#12 AWG Cross Section	
45A PCB Recommended Traces	#10 AWG Cross Section	
Min. Creepage / Clearance Distance PCB	in.	mm
25A Creepage & Clearance Adjacent Poles	0.201	5.1
45A Creepage & Clearance Adjacent Poles	0.067	1.7
Mechanical Shock ⁴		
MIL-STD-202	213 Condition A	50g's
Vibration High Frequency ⁴		
MIL-STD-202	204 Condition A	10g's

Protection	
Touch Safety with Finger Proof Housings & Wire Contacts or PCB Mating Interface	
UL1977 Sec. 10.2	Pass
IEC 60950	Pass
IEC 60529	IP20
Touch Safety Standard Housings	
IEC 60529	IP10

* No TUV Recognition
¹ Based on: 105°C rated or better cable of the largest size, Properly calibrated APP® recommended tooling, and a 25°C ambient temperature. UL rating not to exceed the maximum operating temperature. CSA rating below a 30°C temperature rise.
² Limited by the thermal properties of the connector plastic housing.
³ Use APP® recommended tooling only. Alternate tools may adversely affect the performance of our connectors along with UL and CSA recognition.
⁴ Tested with contact part number 261G2.

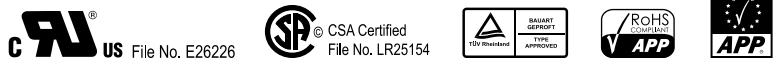

PP15-45 TEMPERATURE CHARTS |

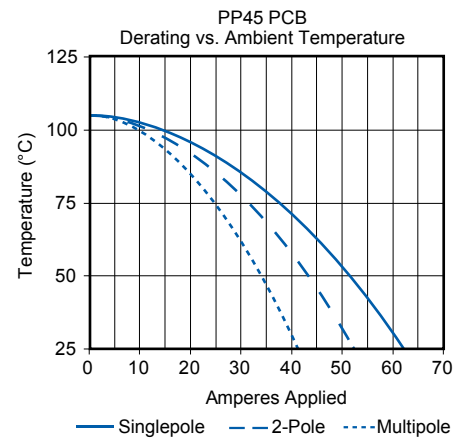
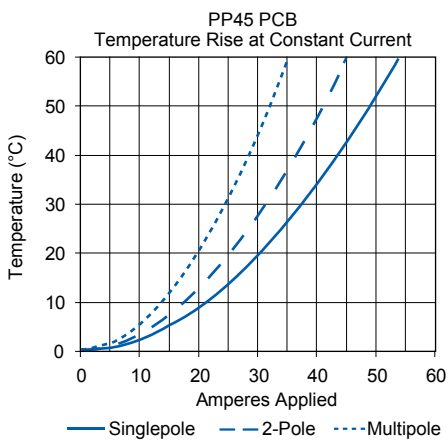
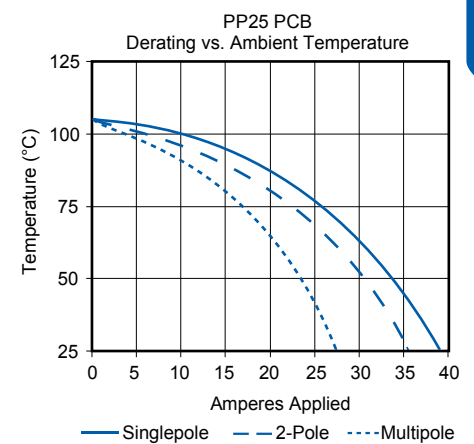
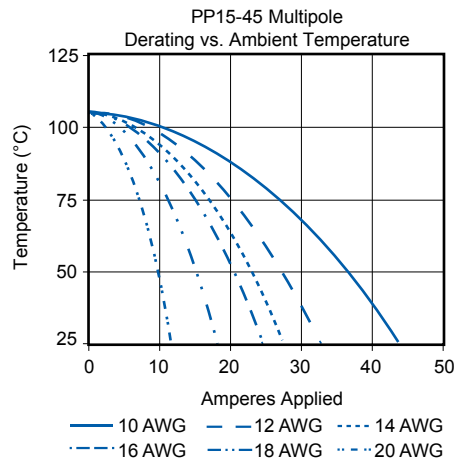
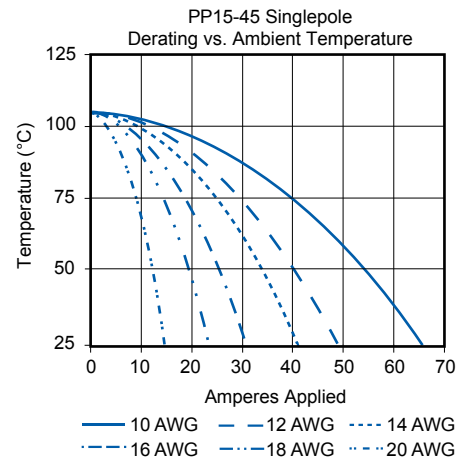
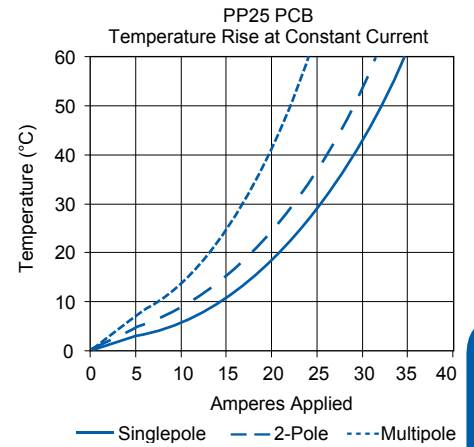
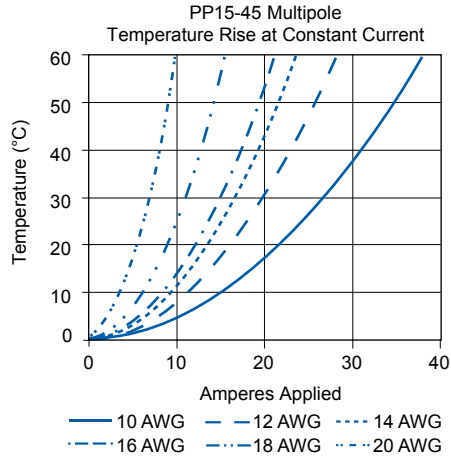
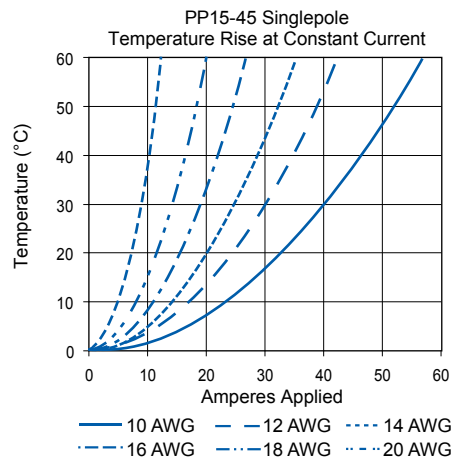

NOTE: Temperature rise charts are based on a 25°C ambient temperature. PP25 PCB charts based on 0.002 in² foil on board side, mated to #12 AWG conductor on wire side. PP45 PCB charts based on #10 AWG equivalent copper foil on board side, mated to #10 AWG conductor on wire side.

| Powerpole® 15-45 Accessories |

Mounting Wing

Secure dovetailed Powerpole® 15-45 series housings by passing fasteners through the wings in either a horizontal or vertical orientation. Useful for sheet metal panels, printed circuit boards, and many other mounting surfaces. Fasteners not included.

Description	----- Part Numbers -----	
Minimum Quantity ...	2,500	100
Red	1399G9-BK	1399G9
Blue	1399G8-BK	1399G8

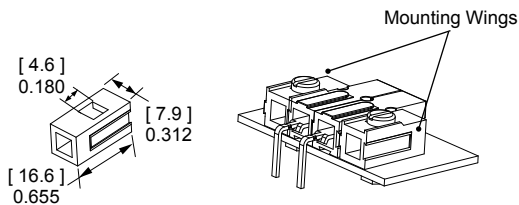

Spacer

Used to separate housings under high power to minimize derating. They are recommended for squaring off a block of Powerpole® 15-45 housings for use in connector shells and mounting clamps. Use a combination of long and short spacers opposite each other in a mated block to add keying features or use two short spacers to avoid interference. Spacers with holes can also be used to fasten the blocked housings to a surface with a fastener.

Description	----- Part Numbers -----	
Minimum Quantity	2,500	100
Red, Short w/ Hole	1399G1-BK	1399G1
Red, Long	1399G2-BK	1399G2
Red, Short	1399G6-BK	1399G6
Black, Long	1399G10-BK	1399G10
Blue, Short	1399G13-BK	1399G13
White, Short w/ Hole	1399G14-BK	1399G14
White, Long	1399G17-BK	1399G17

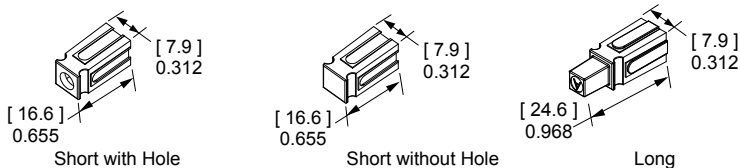

Retaining Pins

Keep stacked Powerpole® 15-45 series housings from separating. Retaining pins are inserted in the circular opening between two housings stacked side by side.

Description	----- Part Numbers -----		Dimensions			
			- A -		- B -	
Minimum Quantity ...	1,000	100			
1 Block High	H1507P38	110G16	0.094	2.390	0.250	6.350
2 Block High	111812P5	110G17	0.099 / 0.106	0.251 / 2.69	0.440	11.180

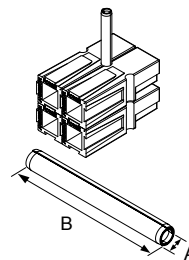

Mounting Clamp

Mounting clamps can be used for fastening a block of Powerpole® 15-45 series housings to a panel. Connector blocks must be a complete square for the clamps to work properly. Fastening hardware not included.

Description	-- Part Numbers --
Minimum Quantity ...	100 sets of 2
2 or 4 Pole	1462G1
3 or 6 Pole	1462G2
4 or 8 Pole	1462G3

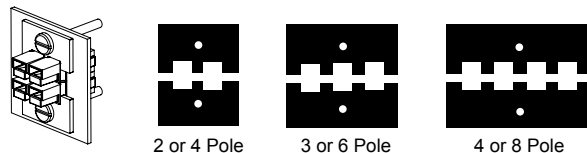

PCB Mounting Staples

PCB staples are soldered into place to secure Powerpole® 15-45 series housings in a horizontal configuration to the board. Reduce strain on soldering joints during mating and unmating.

Part Numbers	H x W	Length	Dimensions			
			- A -		- B -	
			inches	mm	inches	mm
Minimum Quantity 100						
114555P1	1 x 1	Short	0.47	12.0	0.28	7.0
114555P2	1 x 2	Short	0.47	12.0	0.57	14.5
114555P3	1 x 3	Short	0.47	12.0	0.89	22.5
114555P7	1 x 4	Short	0.47	12.0	1.20	30.5
114555P12	1 x 4	Long	0.67	17.0	1.20	30.5
114555P8	1 x 6	Short	0.47	12.0	1.83	46.5
114555P10	2 x 1	Short	0.79	20.0	0.28	7.0
114555P6	2 x 2	Short	0.79	20.0	0.57	14.5
114555P9	2 x 2	Long	0.91	23.0	0.57	14.5
114555P14	2 x 5	Long	0.91	23.0	1.52	38.5
114555P4	3 x 2	Short	1.10	28.0	0.57	14.5

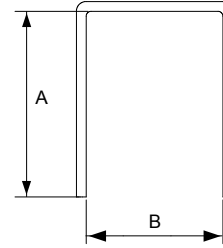

Retention Clip

Retention clips prevent Powerpole® 15-45 blocks from unintended disconnects. They feature a tab for easy insertion and removal.

Description	-- Part Number --
Minimum Quantity 100	
1 Block High	110G68

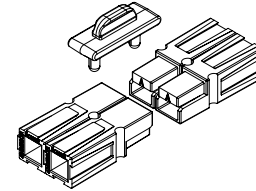

Block Lok

Block locks secure mated Powerpole® 15-45 series housings together. For use in high vibration or shock applications where connectors are unmated infrequently.

Description	- Part Numbers -
Minimum Quantity 100	
2 Pole, Black	110G21
4 Pole, Black	110G12

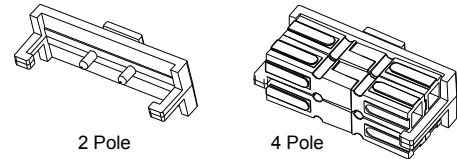

2 Pole 4 Pole
Shown without Powerpoles® Shown with Powerpoles®

Splash Boot

Splash boots protect a 2x2 block of any combination of Powerpole® 15-45 series housings and feature snip off sealed ends for flexibility in wire O.D. Designed for through panel or inline applications. Not a hermetic seal.

Description	- Part Numbers -
Minimum Quantity 25	
Female, Black	1441G1
Male, Black	1442G1

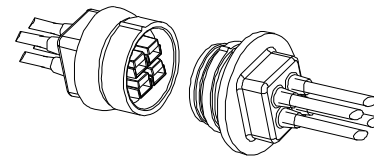

For environmentally sealed connector shells to hold Powerpole® 15-180 connectors, see APP's SPEC Pak® product series on our website, www.andersonpower.com



Powerpole® - Tooling Information

Wire Size		Reeled Part Numbers		Reeled Contact Crimp Tool				
AWG	mm ²	Tin Plating	Silver Plating	APP Applicator	APP Press	ATS Applicator	ATS Press	Air Feed Kit *
PP15 / 45 Flat Wiping Power & Ground								
#16 / 20	1.3 / 0.52	262G1	262G2	TD0101	115V= TE0101 230V = TE0102	1385519-1	1725900-2 or [354500-1]	1424266-1 or [354578-1]
#16 / 20	1.3 / 0.52	269G2	N/A			1385519-1		
#12 / 16	3.3 / 1.3	261G1	261G4			1385520-1		
#10 / 14	5.3 / 2.1	261G2	261G3			1385458-1		
#12 / 16	3.3 / 1.3	269G1	N/A			1385520-1		
#10 / 14	5.3 / 2.1	269G3	N/A			1385458-1		
#10 / 14	5.3 / 2.1	200G1L	200G3L	TD0102		1385460-1		
#10 / 14	5.3 / 2.1	201G1H	201G3H			1385460-1		
#10 / 14	5.3 / 2.1	1830G1	1830G2			1385460-1		

NOTE: Insertion / Extraction tool for PP15/45 contacts = 111038G2

* All ATS applicators for APP® contacts are air feed style, (except 1385870) and require the press to have an air feed kit installed. APP applicators are mechanical feed style and do not require an air feed kit.

Wire Size		Loose Piece Part Numbers		Loose Piece Contact Crimp Tool				
AWG	mm ²	Tin Plating	Silver Plating	Hand Tool	Pneumatic Bench Tool	Die	Locator	Number of Crimps
PP15 / 45 Flat Wiping Power & Ground								
#16 / 20	1.3 / 0.52	N/A	1332	1309G2 or 1309G8	1367G1			
#12 / 16	3.3 / 1.3	N/A	1331					
#16 / 20	1.3 / 0.52	262G1-LPBK	262G2-LPBK	1309G3 or 1309G8	N/A	N/A	N/A	Single
#16 / 20	1.3 / 0.52	269G2-LPBK	N/A					
#12 / 16	3.3 / 1.3	261G1-LPBK	261G4-LPBK					
#10 / 14	5.3 / 2.1	261G2-LPBK	261G3-LPBK					
#12 / 16	3.3 / 1.3	269G1-LPBK	N/A					
#10 / 14	5.3 / 2.1	269G3-LPBK	N/A					
#10 / 14	5.3 / 2.1	200G1L-LPBK	200G3L-LPBK	1309G6 or 1309G8				
#10 / 14	5.3 / 2.1	201G1H-LPBK	201G3H-LPBK					
310 / 14	5.3 / 2.1	1830G1-LPBK	1830G2-LPBK					
PP75								
#6	13.3	N/A	1307	1309G4	1387G1	1388G6	1389G6	Single
			5900					
#8	8.4		5952					
#10 / 12	5.3 / 3.3		5953					
			5915			1388G7		
PP120								
1/0	53.5	N/A	1323G2	1368 Series	1387G1	1388G3	1389G4	Single
#1	42.4		1323G1					
#2	33.6		1319					
#4	21.2		1319G4					
#6	13.3		1319G6					
PP180								
3/0	85	N/A	1328G2	1368 Series	1387G2	1303G12	1304G32	Double
2/0	53.5		1328G1					
1/0	53.5		1382					
#1	42.4		1347					
#2	33.6		1383					
#4	21.1		1384					
#6	13.3	1348		1387G1	1388G4	1389G3	Single	

- NOTE: See website for the most current information.
- NOTE: Insertion / Extraction tool for PP15/45 contacts = 111038G2



Компания «ЭлектроПласт» предлагает заключение долгосрочных отношений при поставках импортных электронных компонентов на взаимовыгодных условиях!

Наши преимущества:

- Оперативные поставки широкого спектра электронных компонентов отечественного и импортного производства напрямую от производителей и с крупнейших мировых складов;
- Поставка более 17-ти миллионов наименований электронных компонентов;
- Поставка сложных, дефицитных, либо снятых с производства позиций;
- Оперативные сроки поставки под заказ (от 5 рабочих дней);
- Экспресс доставка в любую точку России;
- Техническая поддержка проекта, помощь в подборе аналогов, поставка прототипов;
- Система менеджмента качества сертифицирована по Международному стандарту ISO 9001;
- Лицензия ФСБ на осуществление работ с использованием сведений, составляющих государственную тайну;
- Поставка специализированных компонентов (Xilinx, Altera, Analog Devices, Intersil, Interpoint, Microsemi, Aeroflex, Peregrine, Syfer, Eurofarad, Texas Instrument, Miteq, Cobham, E2V, MA-COM, Hittite, Mini-Circuits, General Dynamics и др.);

Помимо этого, одним из направлений компании «ЭлектроПласт» является направление «Источники питания». Мы предлагаем Вам помощь Конструкторского отдела:

- Подбор оптимального решения, техническое обоснование при выборе компонента;
- Подбор аналогов;
- Консультации по применению компонента;
- Поставка образцов и прототипов;
- Техническая поддержка проекта;
- Защита от снятия компонента с производства.



Как с нами связаться

Телефон: 8 (812) 309 58 32 (многоканальный)

Факс: 8 (812) 320-02-42

Электронная почта: org@eplast1.ru

Адрес: 198099, г. Санкт-Петербург, ул. Калинина, дом 2, корпус 4, литера А.