

# Honeywell Sensing and Control AML/MML Selection Guide

# Honeywell Sensing and Control AML/MML Selection Guide

## AML11 Solid state pushbutton switches

### AML11 INCANDESCENT OR NON-LIGHTED DISPLAY ORDER GUIDE

| <b>AML11B</b>  |  | <b>B</b>           | <b>A</b>   | <b>2</b>   | <b>EA</b>              |                        |                        |
|--|--|--------------------|--|--|------------------------|------------------------|------------------------|
| <b>Housing Type</b>  |  | <b>Bezel Color</b> | <b>Incandescent Lamp Type</b>                              | <b>Terminal Type</b>   | <b>Circuitry Codes</b> |                        |                        |
| <b>Standard Bezel</b><br><b>AML11B</b> Square non-lighted<br><b>AML11C</b> Square 1 lamp ckt.<br><b>AML11E</b> Rect. non-lighted<br><b>AML11F</b> Rect. 1 lamp ckt.<br><b>AML11G</b> Rect. 2 lamp ckts.<br><br><b>Full Guard Bezel</b><br><b>AML11H</b> Square non-lighted<br><b>AML11J</b> Square 1 lamp ckt.<br><b>AML11K</b> Rect. non-lighted<br><b>AML11L</b> Rect. 1 lamp ckt.<br><b>AML11M</b> Rect. 2 lamp ckts. |  | <b>B</b><br>Black  | <b>A</b><br>No lamp installed<br><br><b>E</b><br>28 V lamp | <b>2</b><br>.110 x .020<br>(solder or quick-connect)<br><br><b>3</b><br>.025 x .025<br>(printed, circuit or push-on) | 4.5-24 VDC Sinking     | <b>EA</b><br>Momentary | <b>EE</b><br>Alternate |

Discount **BE**  
 Schedule Qty.: 25 pieces/listing  
 Unclass.

Example: **AML11BBA2EA**  
 Square, pushbutton switch housing, non-lighted; black bezel; .110 x .020 termination; momentary action; current-sinking output for use with 5-volt supply.

## AML12 Solid state pushbutton switches

### AML12 LED DISPLAY ORDER GUIDE

| <b>AML12C</b>  |  | <b>B</b>           | <b>B</b>  | <b>2</b>   | <b>EA</b>              |                        |                        |
|--|--|--------------------|---|--|------------------------|------------------------|------------------------|
| <b>Housing Type</b>  |  | <b>Bezel Color</b> | <b>LED Color/ Voltage</b>   | <b>Terminal Type/ Diode Protection</b>   | <b>Circuitry Codes</b> |                        |                        |
| <b>Standard Bezel</b><br><b>AML12C</b> Square 1 LED<br><br><b>Full Guard Bezel</b><br><b>AML12J</b> Square 1 LED |  | <b>B</b><br>Black  | <b>Red</b><br><b>B</b> 5V<br><b>C</b> 5V<br><br><b>Yellow</b><br><b>J</b> 5V<br><b>M</b> 24V<br><br><b>Green</b><br><b>S</b> 5V<br><b>X</b> 24V | <b>2</b><br>.110 x .020<br>(solder or quick-connect)<br><br><b>3</b><br>.025 x .025<br>(printed, circuit or push-on)<br><br><b>8</b><br>.110 x .020<br>with diode protection | 4.5 - 24 VDC Sinking   | <b>EA</b><br>Momentary | <b>EE</b><br>Alternate |

Discount **BE**  
 Schedule Qty.: 25 pieces/listing  
 Unclass.

Example: **AML12CBB2EA**  
 Square, pushbutton switch housing; black bezel; red LED; .110 x .020 termination; current-sinking output for use with 5-volt supply; momentary action.

# Honeywell Sensing and Control AML/MML Selection Guide

## AML21 Electronic control pushbutton switches

### AML21 INCANDESCENT OR NON-LIGHTED DISPLAY ORDER GUIDE

| <u>AML21B</u>  | <u>B</u>  | <u>A</u>  | <u>2</u>   | <u>AA</u>  |                 |   |               |  |                             |  |
|--|---|---|--|--|-----------------|---|---------------|--|-----------------------------|--|
| <b>Housing Type</b>  | <b>Bezel Color</b>  | <b>Incandescent Lamp Type</b>   | <b>Terminal Type</b>   | <b>Circuitry Codes (Each pole has double-throw)</b>  |                 |   |               |  |                             |  |
| <b>Standard Bezel</b><br><b>AML21B</b> Square non-lighted<br><b>AML21C</b> Square 1 lamp ckt.<br><b>AML21E</b> Rect. non-lighted<br><b>AML21F</b> Rect. 1 lamp ckt.<br><b>AML21G</b> Rect. 2 lamp ckts.<br><br><b>Full Guard Bezel</b><br><b>AML21H</b> Square non-lighted<br><b>AML21J</b> Square 1 lamp ckt.<br><b>AML21K</b> Rect. non-lighted<br><b>AML21L</b> Rect. 1 lamp ckt.<br><b>AML21M</b> Rect. 2 lamp ckts. | <b>B</b><br>Black   | <b>A</b><br>No lamp installed<br><br><b>B</b><br>6 V lamp<br><br><b>C</b><br>14 V lamp<br><br><b>E</b><br>28 V lamp | <b>2</b><br>.110 x .020 (solder or quick-connect)<br><br><b>3</b><br>.025 x .025 (printed ckt. or push-on) | <table border="1"> <tr> <td style="text-align: center;">Silver Contacts</td> <td> <b>Mom. Action.</b><br/> <b>AA</b> 1-pole<br/> <b>AC</b> 2-pole<br/> <b>CC</b> 4-pole<br/><br/> <b>Alt. Action</b><br/> <b>AB</b> 1-pole<br/> <b>AD</b> 2-pole<br/> <b>CD</b> 4-pole                 </td> </tr> <tr> <td style="text-align: center;">Gold Contacts</td> <td> <b>Mom. Action</b><br/> <b>BA</b> 1-pole<br/> <b>BC</b> 2-pole<br/> <b>DC</b> 4-pole<br/><br/> <b>Alt. Action</b><br/> <b>BB</b> 1-pole<br/> <b>BD</b> 2-pole<br/> <b>DD</b> 4-pole                 </td> </tr> <tr> <td style="text-align: center;">Gold-plated Silver Contacts</td> <td> <b>Mom. Action</b><br/> <b>EA</b> 1-pole<br/> <b>EC</b> 2-pole                 </td> </tr> </table> | Silver Contacts | <b>Mom. Action.</b><br><b>AA</b> 1-pole<br><b>AC</b> 2-pole<br><b>CC</b> 4-pole<br><br><b>Alt. Action</b><br><b>AB</b> 1-pole<br><b>AD</b> 2-pole<br><b>CD</b> 4-pole | Gold Contacts | <b>Mom. Action</b><br><b>BA</b> 1-pole<br><b>BC</b> 2-pole<br><b>DC</b> 4-pole<br><br><b>Alt. Action</b><br><b>BB</b> 1-pole<br><b>BD</b> 2-pole<br><b>DD</b> 4-pole | Gold-plated Silver Contacts | <b>Mom. Action</b><br><b>EA</b> 1-pole<br><b>EC</b> 2-pole |
| Silver Contacts  | <b>Mom. Action.</b><br><b>AA</b> 1-pole<br><b>AC</b> 2-pole<br><b>CC</b> 4-pole<br><br><b>Alt. Action</b><br><b>AB</b> 1-pole<br><b>AD</b> 2-pole<br><b>CD</b> 4-pole |   |  |  |                 |   |               |  |                             |  |
| Gold Contacts  | <b>Mom. Action</b><br><b>BA</b> 1-pole<br><b>BC</b> 2-pole<br><b>DC</b> 4-pole<br><br><b>Alt. Action</b><br><b>BB</b> 1-pole<br><b>BD</b> 2-pole<br><b>DD</b> 4-pole  |   |  |  |                 |   |               |  |                             |  |
| Gold-plated Silver Contacts  | <b>Mom. Action</b><br><b>EA</b> 1-pole<br><b>EC</b> 2-pole  |   |  |  |                 |   |               |  |                             |  |

Discount **BE**  
 Schedule Qty.: 25 pieces/listing  
 Unclass.

Example: **AML21BBA2AA**  
 Square, pushbutton switch housing, non-lighted; black bezel; .110 x .020 termination; 1-pole, double throw; silver contacts.

## AML22 Electronic control pushbutton switches

### AML22 LED DISPLAY ORDER GUIDE

| <u>AML22C</u>  | <u>B</u>  | <u>B</u>   | <u>2</u>  | <u>AA</u>  |                 |   |               |  |
|--|---|--|---|--|-----------------|---|---------------|--|
| <b>Housing Type</b>  | <b>Bezel Color</b>  | <b>LED Color/Voltage</b>   | <b>Terminal Type</b>  | <b>Circuitry Codes (Each pole has double-throw)</b>  |                 |   |               |  |
| <b>Standard Bezel</b><br><b>AML22C</b> Square 1 LED<br><b>AML22H</b> Square 1 high profile LED (for use with AML-52A buttons)<br><br><b>Full Guard Bezel</b><br><b>AML22J</b> Square 1 LED | <b>B</b><br>Black   | <b>Red</b><br><b>B</b> V<br><b>C</b> 5V<br><b>D</b> 10V<br><b>E</b> 15V<br><b>F</b> 24V<br><br><b>Yellow</b><br><b>H</b> V<br><b>J</b> 5V<br><b>K</b> 10V<br><b>L</b> 15V<br><b>M</b> 24V<br><br><b>Green</b><br><b>R</b> V<br><b>S</b> 5V<br><b>T</b> 10V<br><b>W</b> 15V<br><b>X</b> 24V | <b>2</b><br>.110 x .020 (solder or quick-connect)<br><br><b>3</b><br>.025 x .025 (printed ckt. or push-on)<br><br><b>8</b><br>.110 x .020 with diode protection | <table border="1"> <tr> <td style="text-align: center;">Silver Contacts</td> <td> <b>Mom. Action.</b><br/> <b>AA</b> 1-pole<br/> <b>AC</b> 2-pole<br/><br/> <b>Alt. Action</b><br/> <b>AB</b> 1-pole<br/> <b>AD</b> 2-pole<br/> <b>CD</b> 4-pole                 </td> </tr> <tr> <td style="text-align: center;">Gold Contacts</td> <td> <b>Mom. Action</b><br/> <b>BA</b> 1-pole<br/> <b>BC</b> 2-pole<br/><br/> <b>Alt. Action</b><br/> <b>BB</b> 1-pole<br/> <b>BD</b> 2-pole<br/> <b>DD</b> 4-pole                 </td> </tr> </table> | Silver Contacts | <b>Mom. Action.</b><br><b>AA</b> 1-pole<br><b>AC</b> 2-pole<br><br><b>Alt. Action</b><br><b>AB</b> 1-pole<br><b>AD</b> 2-pole<br><b>CD</b> 4-pole | Gold Contacts | <b>Mom. Action</b><br><b>BA</b> 1-pole<br><b>BC</b> 2-pole<br><br><b>Alt. Action</b><br><b>BB</b> 1-pole<br><b>BD</b> 2-pole<br><b>DD</b> 4-pole |
| Silver Contacts  | <b>Mom. Action.</b><br><b>AA</b> 1-pole<br><b>AC</b> 2-pole<br><br><b>Alt. Action</b><br><b>AB</b> 1-pole<br><b>AD</b> 2-pole<br><b>CD</b> 4-pole |  |   |  |                 |   |               |  |
| Gold Contacts  | <b>Mom. Action</b><br><b>BA</b> 1-pole<br><b>BC</b> 2-pole<br><br><b>Alt. Action</b><br><b>BB</b> 1-pole<br><b>BD</b> 2-pole<br><b>DD</b> 4-pole  |  |   |  |                 |   |               |  |

Discount **BE**  
 Schedule Qty.: 25 pieces/listing  
 Unclass.

Example: **AML22CBB2AA**  
 Square, pushbutton switch housing with one LED, black bezel; red LED (without resistor); .110 x .020 termination; momentary action; 1-pole, double throw; silver contacts.

# Honeywell Sensing and Control AML/MML Selection Guide

## AML23 Solid state pushbutton switches

### AML23 INCANDESCENT OR NON-LIGHTED DISPLAY ORDER GUIDE

| AML23E  | B                       | A  | 2   | AA   | 01   |
|---|-------------------------|--|---|--|--|
| Housing Type  | Operator/ Bezel Color   | Incandescent Lamp Type   | Terminal Type   | Circuitry Codes  | Operating Action   |
| <b>AML23E</b><br>Rectangular<br>non-lighted<br><br><b>AML23F</b><br>Rectangular<br>1 lamp ckt. (A)<br><br><b>AML23G</b><br>Rectangular<br>2 lamp ckts.(A & B) | <b>B</b><br>Black/Black | <b>A</b><br>No lamp<br>installed<br><br><b>B</b><br>6 V lamp<br><br><b>C</b><br>14 V lamp<br><br><b>E</b><br>28 V lamp | <b>2</b><br>.110 x .020<br>(solder or<br>quick-connect)<br><br><b>3</b><br>.025 x .025<br>(printed, ckt.<br>or push-on) | <b>Silver Contacts</b><br><b>AA</b> 1-pole①<br><b>AC</b> 2-pole①<br><b>CA</b> 2-pole<br><b>CC</b> 4-pole①<br><br><b>Gold Contacts</b><br><b>BA</b> 1-pole<br><br>Insert code<br>letters as shown<br>in Circuitry Chart | No<br>charge<br><br>Insert Code<br>numbers from<br>Operating<br>Action Chart |

Discount **BE**  
Schedule Qty.: **25** pieces/listing  
Unclass.

Example: **AML23EBA2AA01**  
Rectangular, non-lighted paddle switch housing; black paddle and bezel;  
.110 x .020 terminals; with one circuit ON and one circuit OFF in each extreme  
operator position (maintained).

① for non-illuminated switches only.

### CIRCUITRY

| Silver Contacts | Gold Contacts | 2-Position |  | 3-Position |  |  |  |
|-----------------|---------------|------------|--|------------|--|--|--|
| <b>AA</b>       | <b>BA</b>     |            |  |            |  |  |  |
| <b>AC</b>       | <b>BC</b>     |            |  |            |  |  |  |
| <b>CA</b>       | <b>DA</b>     |            |  |            |  |  |  |
| <b>CC</b>       | <b>CC</b>     |            |  |            |  |  |  |

### OPERATING ACTION

| 2-Position |                     |        |
|------------|---------------------|--------|
| Maint.     | <b>01</b><br>None   | Maint. |
| Mom.       | <b>02</b><br>None   | Maint. |
| Maint.     | <b>03</b><br>None   | Mom.   |
| 3-Position |                     |        |
| Maint.     | <b>04</b><br>Maint. | Maint. |
| Mom.       | <b>05</b><br>Maint. | Mom.   |
| Maint.     | <b>06</b><br>Maint. | Mom.   |
| Mom.       | <b>07</b><br>Maint. | Maint. |

# Honeywell Sensing and Control AML/MML Selection Guide

## AML25 Electronic control paddle switches

### AML25 LED DISPLAY ORDER GUIDE

| AML25F  | B                       | B  | 2   | AA  | 01   | R  | X  |
|---|-------------------------|--|---|---|--|--|--|
| Housing Type  | Operator/ Bezel Color   | LED Voltage  | Terminal Type/ Diode Protection   | Circuitry Codes   | Operating Code   | LED Color (LED A)  | LED Color (LED B)  |
| <b>AML25F</b><br>Rectangular<br>1 LED<br><br><b>AML25G</b><br>Rectangular<br>2 LEDs | <b>B</b><br>Black/Black | <b>B</b><br>V<br><br><b>C</b><br>5 V<br><br><b>D</b><br>10 V<br><br><b>E</b><br>15 V<br><br><b>F</b><br>24 V | <b>2</b><br>.110 x .020<br>(solder or<br>quick-connect)<br><br><b>3</b><br>.025 x .025<br>(printed ckt.<br>or push-on)<br><br><b>8</b><br>.110 x .020<br>with diode<br>protection | <b>Silver Contacts</b><br><b>AA</b><br>1-pole<br><br><b>CA</b><br>2-pole<br><br><b>Gold Contacts</b><br><b>BA</b><br>1-pole<br><br><b>DA</b><br>2-pole<br><br>Insert code letters<br>as shown in<br>Circuitry Chart | No charge<br><br>Insert code numbers from Operating Action Chart | <b>R</b><br>Red<br><br><b>Y</b><br>Yellow<br><br><b>G</b><br>Green<br><br><b>X</b><br>No LED | <b>R</b><br>Red<br><br><b>Y</b><br>Yellow<br><br><b>G</b><br>Green<br><br><b>X</b><br>No LED |

Discount **BE**  
 Schedule Qty.: 25 pieces/listing  
 Unclass.

Example: **AML25FBB2AA01RX**  
 Rectangular paddle switch; illuminated with one red LED, this device has a black paddle and bezel, and .110 x .020 terminals; with one circuit ON and one circuit OFF in each extreme operator position (maintained).

### CIRCUITRY

| Silver Contacts |           | Gold Contacts                   |  | 2-Position |  | 3-Position |  |  |
|-----------------|-----------|---------------------------------|--|------------|--|------------|--|--|
| <b>AA</b>       | <b>BA</b> |                                 |  |            |  |            |  |  |
| <b>AC</b>       | <b>BC</b> | (Non-illuminated switches only) |  |            |  |            |  |  |
| <b>CA</b>       | <b>DA</b> |                                 |  |            |  |            |  |  |
| <b>CC</b>       | <b>CC</b> | (Non-illuminated switches only) |  |            |  |            |  |  |

### OPERATING ACTION

| 2-Position |                     |        |
|------------|---------------------|--------|
| Maint.     | <b>01</b><br>None   | Maint. |
| Mom.       | <b>02</b><br>None   | Maint. |
| Maint.     | <b>03</b><br>None   | Mom.   |
| 3-Position |                     |        |
| Maint.     | <b>04</b><br>Maint. | Maint. |
| Mom.       | <b>05</b><br>Maint. | Mom.   |
| Maint.     | <b>06</b><br>Maint. | Mom.   |
| Mom.       | <b>07</b><br>Maint. | Maint. |

# Honeywell Sensing and Control AML/MML Selection Guide

## AML24 Electronic control rocker switches

### AML24 INCANDESCENT OR NON-LIGHTED DISPLAY ORDER GUIDE

| AML24E   | B                  | A  | 2  | AA  | 01   |
|--|--------------------|--|--|---|--|
| <b>Housing Type</b>  | <b>Bezel Color</b> | <b>Incandescent Lamp Type</b>  | <b>Terminal Type</b>   | <b>Circuitry Codes</b>  | <b>Operating Action</b>  |
| <b>AML24E</b><br>Rectangular<br>non-lighted<br><br><b>AML24F</b><br>Rectangular<br>1 lamp ckt. (A)<br><br><b>AML24G</b><br>Rectangular<br>2 lamp ckts. | <b>B</b><br>Black  | <b>A</b><br>No lamp<br>installed<br><br><b>B</b><br>6 V lamp<br><br><b>C</b><br>14 V lamp<br><br><b>E</b><br>28 V lamp | <b>2</b><br>.110 x .020<br>(solder or<br>quick-connect)<br><br><b>3</b><br>.025 x .025<br>(printed ckt.<br>or push-on) | <b>Silver Contacts</b><br><b>AA</b> 1-pole<br><b>AC</b> 2-poleⓁ<br><b>CA</b> 2-pole<br><b>CC</b> 4-poleⓁ<br><br><b>Gold Contacts</b><br><b>BA</b> 1-pole<br><b>BC</b> 2-poleⓁ<br><b>DA</b> 2-pole<br><b>DC</b> 4-poleⓁ<br><br>Insert Code letters<br>as shown in<br>Circuitry Chart | No<br>charge<br><br>Insert Code<br>numbers from<br>Operating<br>Action Chart |

Discount **BE**  
 Schedule Qty.: **25** pieces/listing  
 Unclass.

Example: **AML24EBA2AA01**  
 Rectangular, non-lighted rocker switch housing; black bezel; 110 x .020 terminals;  
 .with one circuit ON and one circuit OFF in each extreme operator position (maintained).

Ⓛ for non-illuminated switches only.

### CIRCUITRY

| Silver Contacts |           | Gold Contacts |  | 2-Position |  | 3-Position |  |  |  |
|-----------------|-----------|---------------|--|------------|--|------------|--|--|--|
| <b>AA</b>       | <b>BA</b> |               |  |            |  |            |  |  |  |
| <b>AC</b>       | <b>BC</b> |               |  |            |  |            |  |  |  |
| <b>CA</b>       | <b>DA</b> |               |  |            |  |            |  |  |  |
| <b>CC</b>       | <b>DC</b> |               |  |            |  |            |  |  |  |

### OPERATING ACTION

| 2-Position |                     |        |
|------------|---------------------|--------|
| Maint.     | <b>01</b><br>None   | Maint. |
| Mom.       | <b>02</b><br>None   | Maint. |
| Maint.     | <b>03</b><br>None   | Mom.   |
| 3-Position |                     |        |
| Maint.     | <b>04</b><br>Maint. | Maint. |
| Mom.       | <b>05</b><br>Maint. | Mom.   |
| Maint.     | <b>06</b><br>Maint. | Mom.   |
| Mom.       | <b>07</b><br>Maint. | Maint. |

# Honeywell Sensing and Control AML/MML Selection Guide

## AML26 Electronic control rocker switches\*\*

### AML26 LED DISPLAY ORDER GUIDE

| AML26F           | B           | B           | 2   | AA   | 01  | R                 | X                 |
|------------------|-------------|-------------|---|--|---|-------------------|-------------------|
| Housing Type     | Bezel Color | LED Voltage | Terminal Type/<br>Diode Protection            | Circuitry Codes  | Operating Action                                | LED Color (LED A) | LED Color (LED B) |
| AML26F<br>1 LED  | B<br>Black  | B<br>V      | 2<br>.110 x .020<br>(solder or quick-connect) | <b>Silver Contacts</b><br>AA<br>1-pole<br>CA<br>2-pole | Insert code numbers from Operating Action Chart | R<br>Red          | R<br>Red          |
| AML26G<br>2 LEDs |             | C<br>5 V    | 3<br>.025 x .025<br>(printed ckt. or push-on) | <b>Gold Contacts</b><br>BA<br>1-pole<br>DA<br>2-pole   |   | Y<br>Yellow       | Y<br>Yellow       |
|                  |             | D<br>10 V   | 8<br>.110 x .020<br>with diode protection     | Insert Code letters as shown in Circuitry Chart        |   | G<br>Green        | G<br>Green        |
|                  |             | E<br>15 V   |   |  |   | X<br>No LED       | X<br>No LED       |
|                  |             | F<br>24 V   |   |  |   |                   |                   |

Discount **BE**

Schedule Qty.: 25 pieces/listing  
Unclass.

Example: **AML26FBB2AA01RX**

Rectangular rocker switch; illuminated with one LED, this device has a black bezel, .110 x .020 terminals; with one circuit ON and one circuit OFF in each extreme operator position (maintained).

\*\* NOTE: Contact Customer Service for minimum quantity required to establish or reinstate a catalog listing.

### CIRCUITRY

| Silver Contacts                       | Gold Contacts | 2-Position |  | 3-Position |  |  |  |
|---------------------------------------|---------------|------------|--|------------|--|--|--|
| AA                                    | BA            |            |  |            |  |  |  |
| AC<br>(Non-illuminated switches only) | BC            |            |  |            |  |  |  |
| CA                                    | DA            |            |  |            |  |  |  |
| CC<br>(Non-illuminated switches only) | DC            |            |  |            |  |  |  |

### OPERATING ACTION

| <b>2-Position</b> |              |        |        |
|-------------------|--------------|--------|--------|
| Maint.            | 01<br>None   | Maint. | Maint. |
| Mom.              | 02<br>None   | Maint. | Mom.   |
| Maint.            | 03<br>None   | Mom.   | Mom.   |
| <b>3-Position</b> |              |        |        |
| Maint.            | 04<br>Maint. | Maint. | Maint. |
| Mom.              | 05<br>Maint. | Mom.   | Mom.   |
| Maint.            | 06<br>Maint. | Mom.   | Mom.   |
| Mom.              | 07<br>Maint. | Maint. | Maint. |

# Honeywell Sensing and Control AML/MML Selection Guide

## AML27 Electronic control keylock switches \*\*\*\*

### AML27 NON-LIGHTED ORDER GUIDE

| AML27A                                  | B                  | K                   | 2   | AA   | 21   | BA              |  |  |
|---|--------------------|---------------------|---|--|--|-----------------|--|--|
| <b>Housing Type</b>                     | <b>Bezel Color</b> | <b>Button Color</b> | <b>Terminal Type</b>  | <b>Circuitry Codes (each pole has double throw)</b>  | <b>Operation Action (key out in center position, except where noted)</b> |                 | <b>Key Combinations</b><br><br>(Two keys furnished) |  |
| AML27A<br>Square housing<br>non-lighted | B<br>Black         | K<br>Black          | 2<br>.110 x .020<br>(solder or quick-connect)<br><br>3<br>.025 x .025<br>(printed circuit or push-on) | <b>Silver Contacts</b><br>AA<br>1-pole<br><br>AC<br>2-pole<br><br><b>Gold Contacts</b><br>BA<br>1-pole<br><br>BC<br>2-pole | <b>CCW</b>   | <b>Center</b>   |  | <b>CW</b>  |
|   |                    |                     |   |  | None   | 21<br>Maint.    | Maint.   | <b>BA BB</b><br><b>BK BC</b><br><b>BL BD</b><br><b>BE BS</b><br><b>BF BW</b> |
|   |                    |                     |   |  | None   | 22*<br>Maint.   | Maint.   |  |
|   |                    |                     |   |  | None   | 23<br>Maint.    | Mom.   |  |
|   |                    |                     |   |  | Maint.   | 24<br>Maint.    | Maint.   |  |
|   |                    |                     |   |  | Mom.   | 25<br>Maint.    | Mom.   |  |
|   |                    |                     |   |  | Maint.   | 26**<br>Maint.  | Maint.   |  |
|   |                    |                     |   |  | Mom.   | 27***<br>Maint. | Maint.   |  |
|   |                    |                     |   |  | Maint.   | 28***<br>Maint. | Maint.   |  |
|   |                    |                     |   |  | Maint.   | 29†<br>Maint.   | Maint.   |  |
|   |                    |                     |   |  | Maint.   | 30†<br>Maint.   | Mom.   |  |
|   |                    |                     |   |  | Maint.   | 31††<br>Maint.  | Mom.   |  |

Discount **BE**  
 Schedule Qty: 25 pieces/listing  
 Unclass.

#### REPLACEMENT KEYS

One key per listing  
 Five piece minimum order quantity for keys

| Key Combination | Key Code | Catalog Listing |
|-----------------|----------|-----------------|
| BA              | 110      | 30PA101-AML     |
| BB              | 109      | 30PA102-AML     |
| BD              | 107      | 30PA104-AML     |
| BE              | 106      | 30PA105-AML     |
| BS              | 117      | 30PA117-AML     |
| BT              | 118      | 30PA118-AML     |
| BV              | 119      | 30PA119-AML     |
| BW              | 120      | 30PA120-AML     |

Note: These keys fit the 5-bit keylocks in the Order Guide



Specify different key combinations to acquire different keys, i.e.:

AML27ABK2AA21**BB** and AML27ABK2AA21**BE** have different keys.  
 AML27ABK2AA21**BB** and AML27ABK3BC25**BB** have identical interchangeable keys.

**28** and **29** operating actions should be used with key combinations BA or BB.

Example: **AML27ABK2AA21BA** Square housing; black bezel and button; .110 x .020 terminals; 2-pole double-throw; silver contacts; 3-position maintained and key code "BB".

\*\*\*\* **NOTE:** Contact Customer Service for minimum quantity required to establish or reinstate a catalog listing.



# Honeywell Sensing and Control AML/MML Selection Guide

## AML31 Power duty pushbutton switches\*

### AML31 INCANDESCENT OR NON-LIGHTED DISPLAY ORDER GUIDE

| <b>AML31E</b>   | <b>B</b>                 | <b>A</b>  | <b>4</b>   | <b>AC</b>   |                          |                          |
|---|--------------------------|---|--|---|--------------------------|--------------------------|
| <b>Housing Type</b>   | <b>Bezel Color</b>       | <b>Incandescent Lamp Type</b>   | <b>Terminal Type</b>                                 | <b>Circuitry Codes</b>  |                          |                          |
| <b>Standard Bezel</b><br><b>AML31E</b> Rect. non-lighted<br><b>AML31F</b> Rect. 1 lamp ckt.<br><br><b>Full Guard Bezel</b><br><b>AML31L</b> Rect. 1 lamp ckt. | <b>B</b><br>Black        | <b>A</b><br>No lamp installed<br><br><b>B</b><br>6 V lamp<br><br><b>C</b><br>14 V lamp<br><br><b>E</b><br>28 V lamp | <b>4</b><br>.187 x .020<br>(solder or quick-connect) | 2-pole, single-throw, normally open, Form X<br><br><table style="width: 100%; border: none;"> <tr> <td style="width: 50%; text-align: center;"><b>AD</b><br/>Alt. action</td> <td style="width: 50%; text-align: center;"><b>AC</b><br/>Mom. Action</td> </tr> </table> | <b>AD</b><br>Alt. action | <b>AC</b><br>Mom. Action |
| <b>AD</b><br>Alt. action  | <b>AC</b><br>Mom. Action |   |  |   |                          |                          |

Discount **BE**  
 Schedule Qty.: **25** pieces/listing  
 Unclass.

Example: **AML31EBA4AC**  
 Rectangular pushbutton switch housing, non-lighted; black bezel; .187 x .020 terminals; momentary action; 2-pole, single-throw, normally open, Form X

\* **NOTE:** Contact Customer Service for a minimum quantity required to establish or reinstate a catalog listing.

## AML32 Power duty pushbutton switches\*

### AML32 NEON DISPLAY ORDER GUIDE

| <b>AML32F</b>  | <b>B</b>                 | <b>C</b>   | <b>7</b>  | <b>AA</b>   |                          |                          |
|--|--------------------------|--|---|---|--------------------------|--------------------------|
| <b>Housing Type</b>  | <b>Bezel Color</b>       | <b>Neon Lamp Voltage/Color</b>   | <b>Terminal Type Lamp Circuit</b>   | <b>Circuitry Codes</b>  |                          |                          |
| <b>Standard Bezel</b><br><b>AML32F</b> Rect. 1 Neon lamp<br><br><b>Full Guard Bezel</b><br><b>AML32L</b> Rect. 1 Neon lamp | <b>B</b><br>Black        | <b>Red</b><br><b>B</b> 125 VAC<br><b>C</b> 250 VAC<br><br><b>Clear</b><br><b>K</b> 125 VAC<br><b>L</b> 250 VAC<br><br><b>Green</b><br><b>M</b> 125 VAC<br><b>P</b> 250 VAC | <b>4</b><br>.187 x .020<br>(solder or quick-connect) with isolated lamp circuit<br><br><b>7</b><br>.187 x .020 with integral lamp circuit | 2-pole, single-throw, normally open, Form X<br><br><table style="width: 100%; border: none;"> <tr> <td style="width: 50%; text-align: center;"><b>AD</b><br/>Alt. action</td> <td style="width: 50%; text-align: center;"><b>AC</b><br/>Mom. Action</td> </tr> </table> | <b>AD</b><br>Alt. action | <b>AC</b><br>Mom. Action |
| <b>AD</b><br>Alt. action   | <b>AC</b><br>Mom. Action |  |   |   |                          |                          |

Discount **BE**  
 Schedule Qty.: **25** pieces/listing  
 Unclass.

Example: **AML32FBC7AC**  
 Rectangular pushbutton switch housing; black bezel; 250 volt, red neon lamp; .187 x .020 terminals with integral lamp circuit; momentary action; 2-pole, single-throw, normally open, Form X

\* **NOTE:** Contact Customer Service for minimum quantity required to establish or reinstate a catalog listing.

# Honeywell Sensing and Control AML/MML Selection Guide

## AML33 Power duty paddle switches\*

### AML33 INCANDESCENT OR NON-LIGHTED DISPLAY ORDER GUIDE

| <b>AML33E</b>  | <b>B</b>                | <b>A</b>                         | <b>4</b>  | <b>AA</b>  | <b>01</b>   |
|--|-------------------------|----------------------------------|---|--|---|
| Housing Type   | Operator/ Bezel Color   | Incandescent Lamp Type           | Terminal Type   | Circuitry Codes  | Operating Action  |
| <b>AML33E</b><br>Rectangular<br>non-lighted<br><br><b>AML33F</b><br>Rectangular<br>1 lamp ckt. | <b>B</b><br>Black/Black | <b>A</b><br>No lamp<br>installed | <b>4</b><br>.187 x .020<br>(solder or<br>quick-connect) | <b>Silver Contacts</b><br><b>AA</b><br>1-pole<br>(one Form A<br>single-throw,<br>normally open)<br><br><b>AC</b><br>2-pole<br>(Two Form A) | <br><b>01</b><br>Maint.<br>ON      Maint.<br>OFF |

Discount **BE**  
 Schedule Qty.: **25** pieces/listing  
 Unclass.

Example: **AML33EBA4AA01**  
 Rectangular, non-lighted device; black paddle and bezel; .187 x .020 terminals; 1-pole, Form A Single Throw; with one circuit ON in one extreme position and OFF in the other.

\* **NOTE:** Contact Customer Service for a minimum quantity required to establish or reinstate a catalog listing.

## AML34 Power duty rocker switches\*

### AML34 INCANDESCENT OR NON-LIGHTED DISPLAY ORDER GUIDE

| <b>AML34E</b>   | <b>B</b>          | <b>A</b>                         | <b>4</b>  | <b>AA</b>  | <b>01</b>   |
|---|-------------------|----------------------------------|---|--|---|
| Housing Type  | Bezel Color       | Incandescent Lamp Type           | Terminal Type   | Circuitry Codes  | Operating Action  |
| <b>AML34E</b><br>Rectangular<br>non-illum.<br><br><b>AML34F</b><br>Rectangular<br>1 lamp ckt. | <b>B</b><br>Black | <b>A</b><br>No lamp<br>installed | <b>4</b><br>.187 x .020<br>(solder or<br>quick-connect) | <b>Silver Contacts</b><br><b>AA</b><br>1-pole<br>(one Form A<br>single-throw,<br>normally open)<br><br><b>AC</b><br>2-pole<br>(Two Form A) | <br><b>01</b><br>Maint.<br>ON      Maint.<br>OFF |

Discount **BE**  
 Schedule Qty.: **25** pieces/listing  
 Unclass.

Example: **AML34EBA4AA01**  
 Rectangular, non-illuminated device; black paddle and bezel; .187 x .020 terminals; 1-pole, Form A single throw; with one circuit ON in one extreme position and OFF in the other.

\* **NOTE:** Contact Customer Service for a minimum quantity required to establish or reinstate a catalog listing.

# Honeywell Sensing and Control AML/MML Selection Guide

## AML35 Power duty paddle switches\*

### AML35 NEON DISPLAY ORDER GUIDE

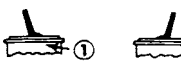
| <b>AML35F</b>                               | <b>B</b>                | <b>B</b>                          | <b>4</b>   | <b>AA</b>  | <b>01</b>   |
|---|-------------------------|-----------------------------------|--|--|---|
| Housing Type                                | Operator/ Bezel Color   | Neon Lamp Voltage                 | Terminal Type/ Lamp Circuit  | Circuitry Codes  | Operating Action  |
| <b>AML35F</b><br>Rectangular<br>1 neon lamp | <b>B</b><br>Black/Black | <b>Red</b><br><b>B</b><br>125 VAC | <b>4</b><br>.187 x .020<br>(solder or quick-connect)<br>with isolated lamp circuit<br><br><b>7</b><br>.187 x .020<br>with integral lamp circuit (available with 2-pole devices only) | <b>Silver Contacts</b><br><b>AA</b><br>(One Form A single-throw)<br>Available only with isolated lamp circuit, term. type 4<br><br><b>AC</b><br>2-pole<br>(Two Form A) | <br><b>01</b><br>Maint. ON    Maint. OFF |

Discount **BE**  
Schedule Qty.: **25** pieces/listing  
Unclass.

Example:**AML35FBB4AA01**  
Rectangular paddle switch housing; black paddle and bezel; 125 VAC neon lamp; .187 x .020 terminals with isolated lamp circuit; 1-pole, Form A single throw; with circuit ON in one extreme position and OFF in the other (maintained).

\* **NOTE:** Contact Customer Service for a minimum quantity required to establish or reinstate a catalog listing.

## AML36 Power duty rocker switches\*

### AML36 NEON DISPLAY ORDER GUIDE

| <b>AML36F</b>                               | <b>B</b>          | <b>B</b>   | <b>4</b>   | <b>AA</b>  | <b>01</b>   |
|---|-------------------|--|--|--|---|
| Housing Type                                | Bezel Color       | Neon Lamp Voltage  | Terminal Type/ Lamp Circuit  | Circuitry Codes  | Operating Action  |
| <b>AML36F</b><br>Rectangular<br>1 neon lamp | <b>B</b><br>Black | <b>Red</b><br><b>B</b><br>125 VAC<br><br><b>C</b><br>250 VAC | <b>4</b><br>.187 x .020<br>(solder or quick-connect)<br>with isolated lamp circuit<br><br><b>7</b><br>.187 x .020<br>with integral lamp circuit (available with 2-pole devices only) | <b>Silver Contacts</b><br><b>AA</b><br>(One Form A single-throw)<br>Available only with isolated lamp circuit, term. type 4.<br><br><b>AC</b><br>2-pole<br>(Two FormA) | <br><b>01</b><br>Maint. ON    Maint. OFF |

Discount **BE**  
Schedule Qty.: **25** pieces/listing  
Unclass.

Example:**AML36FBB4AA01**  
Rectangular rocker switch housing; black bezel; 125 VAC neon lamp; .187 x .020 terminals with isolated lamp circuit; 1-pole Form A single throw; with circuit ON in one extreme position and OFF in the other.

\* **NOTE:** Contact Customer Service for a minimum quantity required to establish or reinstate a catalog listing.

# Honeywell Sensing and Control AML/MML Selection Guide

## AML41/42 Lighted indicators\*

### AML41 INCANDESCENT DISPLAY INDICATORS ORDER GUIDE

| <b>AML41C</b>                                |  | <b>B</b>          | <b>A</b>                      | <b>2</b>   |   |
|--|--|-------------------|-------------------------------|--|---|
| Housing Type                                 |  | Bezel Color       | Incand. Lamp Type             | Terminal Type  |   |
| <b>Pushbutton Style</b>                      | <b>Lens Style</b>                            | <b>B</b><br>Black | <b>A</b><br>No lamp installed | <b>2</b><br>.110 x .020<br>(solder or quick-connect)       | Discount <b>BE</b><br>Schedule Qty.: 25 pieces/listing<br>Unclass.<br><br>Example: <b>AML41CBA2</b><br>Square (pushbutton style)<br>indicator housing with one lamp<br>circuit; black bezel; .110 x .020<br>termination.<br><br>* <b>NOTE:</b> Contact Customer<br>Service for a minimum quantity<br>required to establish or reinstate<br>a catalog listing. |
| <b>AML41C</b><br>Square<br>1 lamp ckt.       | (Use AML51-J,<br>-K, and -L<br>buttons only) |                   | <b>B</b><br>6 V lamp          | <b>3</b><br>.025 x .025<br>(printed circuit<br>or push-on) |   |
| <b>AML41D</b><br>Square,<br>2 lamp ckts.     | <b>AML41J</b><br>Rectangular<br>1 lamp ckt.  |                   | <b>C</b><br>14 V lamp         |  |   |
| <b>AML41F</b><br>Rectangular<br>1 lamp ckt.  | <b>AML41K</b><br>Rectangular<br>2 lamp ckts. |                   | <b>E</b><br>28 V lamp         |  |   |
| <b>AML41G</b><br>Rectangular<br>2 lamp ckts. | <b>AML41L</b><br>Rectangular<br>3 lamp ckts. |                   |                               |  |   |

### AML42 LED DISPLAY INDICATORS ORDER GUIDE

| <b>AML42S</b>   | <b>B</b>          | <b>C</b>  | <b>2</b>   |   |  |
|---|-------------------|---|--|---|--|
| Housing Type  | Bezel Color       | LED Color/<br>Voltage   | Terminal Type/<br>Diode Protection                         |   |  |
| <b>AML42C</b><br>Square<br>1 LED                              | <b>B</b><br>Black | <b>Red</b><br><b>B</b> V<br><b>C</b> 5V<br><b>E</b> 15V<br><b>F</b> 24V     | <b>2</b><br>.110 x .020<br>(solder or q.c.)                | <b>8</b><br>.110 x .020<br>with diode<br>protection | Discount <b>BE</b><br>Schedule Qty.: 25 pieces/listing<br>Unclass.<br><br>Example: <b>AML42SBC2</b><br>Compact indicator with black<br>bezel; 5 volt red LED; .110 x .020<br>termination.<br><br>* <b>NOTE:</b> Contact Customer<br>Service for a minimum quantity<br>required to establish or reinstate<br>a catalog listing. |
| <b>AML42S</b><br>Rectangular<br>1 LED                         |                   | <b>Yellow</b><br><b>H</b> V*<br><b>J</b> 5V<br><b>L</b> 15V<br><b>M</b> 24V | <b>3</b><br>.025 x .025<br>(printed circuit<br>or push-on) |   |  |
| <b>AML42J</b><br>Full guard<br>bezel with 1 LED               |                   | <b>Green</b><br><b>R</b> V<br><b>S</b> 5V<br><b>W</b> 15V<br><b>X</b> 24V   |  |   |  |
| <b>AML42K</b><br>Full guard<br>bezel with high<br>profile LED |                   |   |  |   |  |

# Honeywell Sensing and Control AML/MML Selection Guide

## AML45 Solid state LED annunciators\*

### AML45 ORDER GUIDE

| <u>AML45S</u>  | <u>W</u>               | <u>A</u>                         | <u>2</u>   | <u>RY</u>          |                    |
|--|------------------------|----------------------------------|--|--------------------|--------------------|
| Housing Type   | Color of Housing Bezel | LED Voltage                      | Terminal Type  | LED Color          |                    |
| <b>AML45R</b><br>2 LEDs<br>(for use with full-screen)  | <b>W</b><br>White      | <b>A</b><br>2.4 V                | <b>2</b><br>.110 x .020<br>(solder or quick-connect) | <b>Side 1</b>      | <b>Side 2</b>      |
| <b>AML45S</b><br>2 LEDs<br>(for use with split-screen) | <b>K</b><br>Black      | <b>C</b><br>10 V                 | <b>3</b><br>0.25 x 0.25<br>(printed circuit)         | <b>R</b><br>Red    | <b>R</b><br>Red    |
|  |                        | <b>D</b><br>15 V                 | <b>8</b><br>.110 x .020<br>with diode protection     | <b>Y</b><br>Yellow | <b>Y</b><br>Yellow |
|  |                        | <b>F</b><br>24 V                 |  | <b>G</b><br>Green  | <b>G</b><br>Green  |
|  |                        | <b>*K</b><br>15 V High Intensity |  | <b>A</b><br>Amber  | <b>A</b><br>Amber  |
|  |                        |                                  |  | <b>H</b><br>Red    | <b>H</b><br>Red    |

Discount **BE**  
 Schedule Qty.: 25 pieces/listing  
 Unclass.

Example: **AML45SWA2RY**  
 Split-screen type housing with white bezel, 2.4 V LEDs, .110 x .020 termination; red LED in side 1 and yellow LED in side 2

\*K must have two LEDs – uses A or H LEDs only

**SPACERS:** 30PA1-AML (package of 10) - unclassified

\* **NOTE:** Contact Customer Service for a minimum quantity required to establish or reinstate a catalog listing.

## AML51 Button Parts

### Catalog Listing Description

Full Filter – Square Translucent ▲  
 AML51- Z1 Red  
 -Z2 Yellow  
 -Z3 Green  
 -Z5 White

Full Filter – Rectangular Translucent ▲  
 AML51- Z6 Red  
 -Z7 Yellow  
 -Z8 Green

Split Filter – Rectangular Translucent ▲  
**Catalog listing includes two splits**  
 AML51- Z16 Red  
 -Z20 White

Split Filter – Rectangular Translucent ■  
**Catalog listing includes two splits**  
 AML51- Z42 Red  
 -Z43 Yellow  
 -Z44 Green  
 -Z46 Clear

Discount **BE**  
 Schedule Qty.: 25 pieces/listing  
 Unclass.

Five piece minimum order quantity

- ▲ For use with Clear Cap and Dead Front Buttons
- For use with Projected Color Buttons

**NOTE:** Projected color buttons are the AML51-C10W and AML51-F10W

# Honeywell Sensing and Control AML/MML Selection Guide





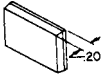
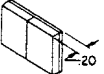
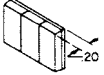



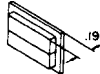

## AML51/52 Lens/Buttons

AML51 LENS ORDER GUIDE (for incandescent display AML41J, K and L indicators)

| AML51J  |  | 10                                  |                     | R                   |   | Discount BE<br>Schedule Qty.: 25 pieces/listing<br>Unclass. |
|---|--|-------------------------------------|---------------------|---------------------|---|---|
| Button Type<br>(Lens style)   | Display/Legend<br>Type   | Full color<br>or 1st<br>color split | 2nd<br>color split  | 3rd<br>color split  |   |   |
| <br><b>AML51-J</b> | <b>Transmitted Color</b><br><b>10</b> No legend<br><b>20</b> With legend                               | <b>R</b><br>Red                     | <b>R</b><br>Red     | <b>R</b><br>Red     | Five piece minimum order quantity for buttons<br><br>Example: <b>AML51-J10R</b><br>Rectangular lens-type button; full color; transmitted color, no legend; red<br><br>** Not available in projected color<br><br>Not all color combinations are available for two and three piece buttons |   |
| <br><b>AML51-K</b> | <b>Transmitted Color</b><br>(clear cap & color insert)<br><b>11</b> No legend<br><b>21</b> With legend | <b>Y</b><br>Yellow                  | <b>Y</b><br>Yellow  | <b>Y</b><br>Yellow  |   |   |
| <br><b>AML51-L</b> | <b>Dead Front</b><br>(smoky gray cap & color insert)<br><b>30</b> No legend<br><b>40</b> With legend   | <b>G</b><br>Green                   | <b>G</b><br>Green   | <b>G</b><br>Green   |   |   |
|   | <b>Projected color</b><br>(white cap & color insert)<br><b>50</b> No legend<br><b>60</b> With legend   | <b>B</b><br>Blue                    | <b>B</b><br>Blue    | <b>B</b><br>Blue    |   |   |
|   |  | <b>W</b><br>White                   | <b>W</b><br>White   | <b>W</b><br>White   |   |   |
|   |  | <b>A**</b><br>Amber                 | <b>A**</b><br>Amber | <b>A**</b><br>Amber |   |   |

## AML51 Buttons for switches and indicators

AML51 PUSH BUTTON ORDER GUIDE

| AML51-C  |  |  | 10   |   | R   |  | -                  |  |
|--|--|--|--|---|---|--|--------------------|--|
| Button Type<br>(Push Button Type)  |  |  | Display/Legend<br>Type   |   | Full Color or<br>1st Color Split  |  | 2nd<br>Color Split |  |
| For switches or indicators:<br><br><br><b>AML51-C</b>   |  |  | <b>Transmitted Color</b><br><b>10</b> No legend<br><b>20</b> With legend<br><br><b>Transmitted Color</b><br>(clear cap & color insert)<br><b>11</b> No legend<br><b>21</b> with legend<br><br><b>Dead Front</b><br>(smoky gray cap & color insert)<br><b>30</b> No legend<br><b>40</b> with legend<br><br><b>Projected color</b><br>(white cap & color insert)<br><b>50</b> No legend<br><b>60</b> with legend | <b>R</b><br>Red<br><br><b>Y</b><br>Yellow<br><br><b>G</b><br>Green<br><br><b>B</b><br>Blue<br><br><b>W</b><br>White<br><br><b>K***</b><br>Black<br><br><b>L***</b><br>Gray<br><br><b>A**</b><br>Amber | <b>R</b><br>Red<br><br><b>Y</b><br>Yellow<br><br><b>G</b><br>Green<br><br><b>B</b><br>Blue<br><br><b>W</b><br>White<br><br><b>K***</b><br>Black<br><br><b>L***</b><br>Gray<br><br><b>A**</b><br>Amber |  |                    |  |
| <br><b>AML51-F</b>  |  |  |  |   |   |  |                    |  |
| <br><b>AML51-G</b>  |  |  |  |   |   |  |                    |  |
| <br><b>AML51-A</b>  |  |  |  |   |   |  |                    |  |
| <br><b>AML51-H</b>  |  |  |  |   |   |  |                    |  |
| <br><b>AML51-N†</b>   |  |  |  |   |   |  |                    |  |
| <br><b>AML51-B</b>  |  |  |  |   |   |  |                    |  |
| <br><b>AML51-E</b>  |  |  |  |   |   |  |                    |  |
| <br><b>AML51-M</b>  |  |  |  |   |   |  |                    |  |
| <br><b>AML51-R</b>  |  |  |  |   |   |  |                    |  |
| For indicators only<br><br><br><b>AML51-D</b><br><br><small>*Available with transmitted color (10 or 20) only</small> |  |  | <small>** Available with transmitted and dead-front only</small><br><small>*** Black and gray not recommended for lighted display</small><br><small>† AML51-N buttons not available with Display/Legend Types 10 and 20</small><br><small>Note: Dimensions include the .060 in bezel</small>   | Example: <b>AML51-C10R</b><br>Square full color button; with transmitted color, no legend; red  |   |  |                    |  |

**NOTE:** AML51 has a \$6.00 net each recurring set-up charge per legend. A one-time charge of \$70.00 applies to establish a new graphic legend.

# Honeywell Sensing and Control AML/MML Selection Guide

## AML52 Buttons

### AML52 BUTTON ORDER GUIDE (for LED/Neon display)

| AML52-N   | 10   | R  |  |
|---|--|--|--|
| <b>Button Type</b>  | <b>Display/Legend Type (see note)</b>  | <b>Button Color</b>  |  |
| <p><b>For LED Devices</b><br/><b>AML52-A</b></p>  <p><b>AML52-C*</b></p>  | <p style="text-align: center;"><b>Transmitted Color</b></p> <p style="text-align: center;"><b>10</b><br/>No legend</p> <p style="text-align: center;"><b>20</b><br/>with legend</p> <p><b>NOTE:</b><br/>AML52 and AML53 have \$6.00 net each recurring set-up charge per legend. A one-time charge of \$70.00 applies to establish a new graphic legend.</p> | <p style="text-align: center;"><b>R</b><br/>Red</p> <p style="text-align: center;"><b>Y</b><br/>Yellow</p> <p style="text-align: center;"><b>G</b><br/>Green</p> <p style="text-align: center;"><b>B</b><br/>Blue</p> <p style="text-align: center;"><b>W</b><br/>White</p> <p style="text-align: center;"><b>K</b><br/>Black</p> <p style="text-align: center;"><b>L</b><br/>Gray</p> | <p>Discount <b>BE</b><br/>Schedule Qty.: <b>25</b> pieces/listing<br/>Unclass.</p> <p>Five piece minimum order quantity for buttons</p> <p>Example:<br/><b>AML52-N10R</b><br/>Rectangular full screen; for use on neon power switch with transmitted color, no legend; red button.</p> |
| <p><b>For Neon Devices</b><br/><b>AML52-N</b></p>    |  |  |  |

\* Not available for lighted display

## AML53 Covers for paddle switches

### AML53 PADDLE SWITCH COVER ORDER GUIDE (for incandescent or non-lighted display)

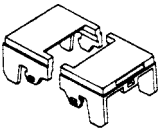
| AML53-T   | 10   | R  | G  |   |
|---|--|--|--|---|
| <b>Paddle Switch Cover Type</b>   | <b>Display/Legend Type</b>   | <b>Cover Color</b>   |  |   |
| <p></p> <p><b>AML53-E</b><br/>1/2 Cover</p> <p></p> <p><b>AML53-T</b><br/>Two-piece cover</p> | <p style="text-align: center;"><b>Transmitted Color</b></p> <p style="text-align: center;"><b>10</b> No legend<br/><b>20</b> With legend</p> <p style="text-align: center;"><b>Transmitted Color</b><br/>(clear cap &amp; color insert)</p> <p style="text-align: center;"><b>11</b> No legend<br/><b>21</b> with legend</p> <p style="text-align: center;"><b>Dead Front</b><br/>(smoky gray cap &amp; color insert)</p> <p style="text-align: center;"><b>30</b> No legend<br/><b>40</b> with legend</p> <p style="text-align: center;"><b>Projected color</b><br/>(white cap &amp; color insert)</p> <p style="text-align: center;"><b>50</b> No legend<br/><b>60</b> with legend</p> | <b>1/2 cover or one side of two-piece cover</b>  | <b>Other side of two-piece cover</b>   | <p><b>Use only with "T" Covers</b></p> <p>Discount <b>BE</b><br/>Schedule Qty.: <b>25</b> pieces/listing<br/>Unclass.</p> <p>Five piece minimum order quantity for buttons</p> <p>Example:<br/><b>AML53-T10RG</b><br/>Two-piece cover; with transmitted color, no legend; red and green.</p> <p><b>NOTE:</b> AML52 and AML53 have \$6.00 net each recurring set-up charge per legend. A one-time charge of \$70.00 applies to establish a new graphic legend.</p> <p><small>* Not for lighted display<br/>** Not available with projected color</small></p> |
|   |  | <p style="text-align: center;"><b>R</b><br/>Red</p> <p style="text-align: center;"><b>Y</b><br/>Yellow</p> <p style="text-align: center;"><b>G</b><br/>Green</p> <p style="text-align: center;"><b>B</b><br/>Blue</p> <p style="text-align: center;"><b>W</b><br/>White</p> <p style="text-align: center;"><b>K*</b><br/>Black</p> | <p style="text-align: center;"><b>R</b><br/>Red</p> <p style="text-align: center;"><b>Y</b><br/>Yellow</p> <p style="text-align: center;"><b>G</b><br/>Green</p> <p style="text-align: center;"><b>B</b><br/>Blue</p> <p style="text-align: center;"><b>W</b><br/>White</p> <p style="text-align: center;"><b>K*</b><br/>Black</p> |   |

# Honeywell Sensing and Control AML/MML Selection Guide

## AML54 Rocker switch operators

AML54 ROCKER OPERATOR ORDER GUIDE (for incandescent or non-lighted display)

| AML54-F  | 10   | R  |  |   |
|--|--|--|--|---|
| Rocker Operator Type   | Display/Legend Type  | Rocker Color   |  |   |
|  <p><b>AML54-F</b><br/>Full rocker</p>      | <p><b>Transmitted Color</b><br/>10 No legend<br/>20 With legend</p> <p><b>Transmitted Color</b><br/>(clear cap &amp; color insert)<br/>11 No legend<br/>21 with legend</p> <p><b>Dead Front</b><br/>(smoky gray cap &amp; color insert)<br/>30 No legend<br/>40 with legend</p> <p><b>Projected color</b><br/>(white cap &amp; color insert)<br/>50 No legend<br/>60 with legend</p> | <p><b>Full rocker, ½ rocker, or one side of two-piece rockers</b></p> <p>R<br/>Red</p> <p>Y<br/>Yellow</p> <p>G<br/>Green</p> <p>B<br/>Blue</p> <p>W<br/>White</p> <p>K*<br/>Black</p> <p>L*<br/>Gray</p> <p>A**<br/>Amber</p> | <p><b>Other side of two-piece rockers</b></p> <p>R<br/>Red</p> <p>Y<br/>Yellow</p> <p>G<br/>Green</p> <p>B<br/>Blue</p> <p>W<br/>White</p> <p>K*<br/>Black</p> <p>L*<br/>Gray</p> <p>A**<br/>Amber</p> | <p>Discount <b>BE</b></p> <p>Schedule Qty.: <b>25</b> pieces/listing<br/>Unclass.</p> <p>Five piece minimum order quantity for buttons</p> <p>Example:<br/><b>AML54-F10R</b><br/>Full rocker; with transmitted color, no legend; red</p> <p>NOTE: AML54 and AML55 have \$6.00 net each recurring set-up charge per legend. A one-time charge of \$70.00 applies to establish a new graphic legend.</p> <p>* Not for lighted display<br/>** Not available with projected color<br/>† Not available for use with AML34 power switches</p> |
|  <p><b>AML54-E</b><br/>½ rocker</p>         |  |  |  |   |
|  <p><b>AML54-T</b><br/>Two-piece rocker</p> |  |  |  |   |

## AML55 Covers for paddle switches

AML55 PADDLE SWITCH COVER ORDER GUIDE (for neon display)

| AML55-N   | 10  | R                                   | Y   |  |
|---|---|-------------------------------------|---|--|
| Paddle Switch Cover Type  | Display/Legend Type (see note)  | Lens Color                          | Cover Color   |  |
|  <p><b>AML55-N</b><br/>Full neon cover with colored lens</p> | <p><b>Transmitted Color</b></p> <p>10<br/>No legend</p> <p>20<br/>with legend</p> | <p>T<br/>Clear</p> <p>R<br/>Red</p> | <p>R<br/>Red</p> <p>Y<br/>Yellow</p> <p>G<br/>Green</p> <p>B<br/>Blue</p> <p>W<br/>White</p> <p>K<br/>Black</p> <p>L<br/>Gray</p> | <p>Discount <b>BE</b></p> <p>Schedule Qty.: <b>25</b> pieces/listing<br/>Unclass.</p> <p>Five piece minimum order quantity for buttons</p> <p>AML55-N covers have a colored lenticular lens window which extends over the neon lamp.</p> <p>Example:<br/><b>AML55-N10RY</b><br/>Full neon paddle switch cover; with transmitted color, no legend; red lens and yellow cover.</p> |



# Honeywell Sensing and Control AML/MML Selection Guide

## AML55 Covers for paddle switches

### AML55 PADDLE SWITCH COVER ORDER GUIDE (for LED display)

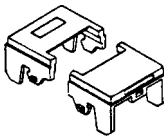
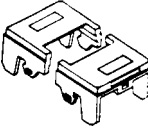
| AML55-T  | 10   | Y  | R  | See notes below   |
|--|--|--|--|---|
| <b>Paddle Switch Cover Type</b><br><br><br><b>AML55-E</b><br>1/2 cover (for 1 LED)*<br><br><br><b>AML55-T</b><br>Two-piece cover (for one LED)<br><br><br><b>AML55-H</b><br>Two-piece cover (for two LEDs) | <b>Display/Legend Type</b><br><br><b>Transmitted Color</b><br>10 No legend<br>20 With legend | <b>Cover Color</b>   |  | Discount <b>BE</b><br><br>Schedule Qty.: <b>25</b> pieces/listing<br>Unclass.<br><br>Five piece minimum order quantity for button.<br><br>AML55-E, -T, and -H covers have an open window which allows LEDs to be flush with the cover surface.<br><br><b>*NOTES:</b><br><sup>1</sup> Only one color code letter is necessary for AML55-E 1/2 covers<br><br><sup>2</sup> To order a 1/2-cover without the LED "window," specify an AML53-E listing.<br><br>Example:<br><b>AML55-T10YR</b><br>Two-piece cover; with LED window in one side, transmitted color, no legend; yellow (LED side) and red (non-LED side).<br><br>NOTE: AML55 has a net \$6.00 recurring set-up charge per legend. A one-time charge of \$70.00 applies to establish a new graphic legend. |
|  |  | 1/2 cover or LED side of two-piece covers*<br><br><b>R</b><br>Red<br><br><b>Y</b><br>Yellow<br><br><b>G</b><br>Green<br><br><b>B</b><br>Blue<br><br><b>W</b><br>White<br><br><b>K</b><br>Black<br><br><b>L</b><br>Gray | Other side of two-piece covers<br><br><b>R</b><br>Red<br><br><b>Y</b><br>Yellow<br><br><b>G</b><br>Green<br><br><b>B</b><br>Blue<br><br><b>W</b><br>White<br><br><b>K</b><br>Black<br><br><b>L</b><br>Gray |   |

# Honeywell Sensing and Control AML/MML Selection Guide

## AML56 Rocker switch operators

### AML56 ROCKER OPERATOR ORDER GUIDE (for neon display)

| AML56-N   | 10   | R  | Y   |   |
|---|--|--|---|---|
| <b>Rocker Operator Type</b><br><br><br><b>AML56-N</b><br>Full rocker with colored lens | <b>Display/Legend Type</b><br><br><b>Transmitted Color</b><br><br>10<br>No legend<br><br>20<br>with legend | <b>Lens Color</b><br><br>T<br>Clear<br><br>R<br>Red<br><br>Y<br>Yellow | <b>Rocker Color</b><br><br>R<br>Red<br><br>Y<br>Yellow<br><br>G<br>Green<br><br>B<br>Blue<br><br>W<br>White<br><br>K<br>Black | Discount <b>BE</b><br>Schedule Qty.: <b>25</b> pieces/listing<br>Unclass.<br><br>Five piece minimum order quantity for buttons<br><br>AML56-N covers have a colored lenticular lens window which extends over the neon lamp.<br><br>Example:<br><b>AML56-N10RY</b><br>Full rocker; with transmitted color, no legend; yellow rocker and red lens<br><br>NOTE: AML56 has a \$6.00 net each recurring set up charge per legend. A one-time charge of \$70.00 applies to establish a new graphic legend. |

## AML56 Rocker switch operators

### AML56 ORDER GUIDE (for LED display)

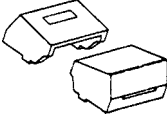
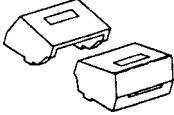
| AML56-T  | 10  | R   | B   |  |
|--|---|---|---|--|
| <b>Rocker Operator Type</b><br><br><br><b>AML56-E</b><br>1/2 rocker* (for 1 LED)<br><br><br><b>AML56-T</b><br>Two-piece rocker (for one LED)<br><br><br><b>AML56-H</b><br>Two-piece rocker (for two LEDs) | <b>Display/Legend Type (see note)</b><br><br><b>Transmitted Color</b><br>10 No legend<br>20 With legend | <b>Rocker Color</b>   |   | Discount <b>BE</b><br>Schedule Qty.: <b>25</b> pieces/listing<br>Unclass.<br><br>Five piece minimum order quantity for button.<br><br>Example:<br><b>AML56-T10RB</b><br>Two-piece rocker; with LED window in one side, transmitted color, no legend; red (LED side) and blue (non-LED side). |
|  |   | <b>1/2 rocker or LED side of two-piece rockers</b><br><br>R<br>Red<br><br>Y<br>Yellow<br><br>G<br>Green<br><br>B<br>Blue<br><br>W<br>White<br><br>K<br>Black<br><br>L<br>Gray | <b>Other side of two-piece rockers</b><br><br>R<br>Red<br><br>Y<br>Yellow<br><br>G<br>Green<br><br>B<br>Blue<br><br>W<br>White<br><br>K<br>Black<br><br>L<br>Gray |  |

# Honeywell Sensing and Control AML/MML Selection Guide

## AML59 Solid state LED annunciators\*

### AML59 ORDER GUIDE

| Cap Style                      | Cap Color         | Legend Type*                       | Filter color       |                    |                    |
|--------------------------------|-------------------|------------------------------------|--------------------|--------------------|--------------------|
|                                |                   |                                    | Full               | Split Screen       |                    |
| <b>AML59-R</b><br>Full screen  | <b>K</b><br>Black | <b>10</b><br>No legend             | <b>R</b><br>Red    | <b>R</b><br>Red    | <b>R</b><br>Red    |
| <b>AML59-S</b><br>Split screen |                   |                                    | <b>Y</b><br>Yellow | <b>Y</b><br>Yellow | <b>Y</b><br>Yellow |
|                                |                   | <b>20*</b><br>Negative Film Legend | <b>G</b><br>Green  | <b>G</b><br>Green  | <b>G</b><br>Green  |
|                                |                   | <b>21*</b><br>Positive Film Legend |                    |                    |                    |

Discount **BE**  
Schedule Qty.: **25** pieces/listing  
Unclass.

Five piece minimum order quantity for buttons

Examples: **AML59-RK10R**  
Full-screen style, black cap, no legend and red filter

**AML59-SK20RY**  
Split-screen style, black cap, negative film legend, red and yellow color filters

\*AML59 has a \$6.00 net each recurring set-up charge per legend. A one-time charge of \$70.00 applies to establish a new graphic legend.

\* **NOTE:** Contact Customer Service for minimum quantity required to establish or reinstate a catalog listing

## AML61 Mounting Hardware\*

Discount **BE**  
Schedule Qty.: **25** pieces/listing  
Unclass.

### AML61 MOUNTING HARDWARE ORDER GUIDE (for standard strip-mount assemblies)

| AML61B                          | A                            | 5                   | A                         |                         |
|---------------------------------|------------------------------|---------------------|---------------------------|-------------------------|
| Type                            | Mounting Bracket Orientation | Number of cans      | Mounting Bracket Location |                         |
| <b>Square cans</b>              | <b>A</b><br>                 | <b>Square Hous.</b> |                           |                         |
| <b>AML61B</b><br>Plain finish   | <b>E</b><br>                 | 1                   |                           |                         |
| <b>AML61J</b><br>(Black finish) |                              | 2                   |                           |                         |
| <b>Rect. cans</b>               | <b>B</b><br>                 | 3                   |                           |                         |
|                                 |                              | 4                   |                           |                         |
|                                 |                              | 5                   |                           |                         |
|                                 |                              | 6                   |                           |                         |
|                                 |                              | 7                   |                           |                         |
|                                 |                              | 8                   |                           |                         |
|                                 | <b>C</b><br>                 | 9                   |                           |                         |
|                                 |                              | 10                  |                           |                         |
|                                 |                              | 11                  |                           |                         |
|                                 |                              | 12                  |                           |                         |
|                                 |                              | <b>Rect. Hous.</b>  |                           | <b>U</b><br>NO BRACKETS |
|                                 |                              | 1                   |                           |                         |

\*To order one rectangular can with mounting brackets on short sides, specify AML61EB1\_\_ or AML61KB1\_\_.

Example: **AML61EC5A**

Five rectangular cans, plain finish (unpainted), long sides abutting; type **A** mounting brackets on long sides, located flush with switch or indicator bezel. (Type **T** bracket brings top of annunciator bezel flush with top of .160 in./4.1 mm panel).

\* **NOTE:** Contact Customer Service for minimum quantity required to establish or reinstate a catalog listing

# Honeywell Sensing and Control AML/MML Selection Guide

## AML71/75/76/78/79 Accessories \*

### AML71 BARRIER ORDER GUIDE

(Barriers shown in order guide are black)

| Barrier Length   | Type   | Catalog Listing |
|--|--------|-----------------|
| Short<br>(For use with square devices and short-side of rectangular devices) | Center | AML71SCB        |
|  | End    | AML71SEB        |
| Long<br>(For use with long side of rectangular devices)                      | Center | AML71LCB        |
|  | End    | AML71LEB        |

Discount **BE**  
Schedule Qty.: 25 pieces/listing  
Unclass.

Notes: Not for use with AML61 mounting hardware  
Not for use with AML41J, K, or L lens-type indicators; or AML45 annunciators

### AML75 PANEL SEAL ORDER GUIDE

| Description | For use with:               |                                  |          |
|-------------|-----------------------------|----------------------------------|----------|
|             | Square 19" high pushbuttons | Rectangular 19" high pushbuttons | Rockers  |
| Base & Seal | AML75ABC                    | AML75BBC                         | AML75RBC |

Discount **BE**  
Schedule Qty.: 25 pieces/listing  
Unclass.

Notes: Multiple units should not be mounted in a single slot, since this would create an unsealed space between each unit. AML75 seals are not for use with barriers, full-guard bezels, AML61 mounting hardware, AML45 annunciators, or AML41J, K or L lens-type indicators.

### AML76 SWITCH ORDER GUIDE

| Guard Type  | Catalog Listing |
|-------------|-----------------|
| Square      | AML76C10T01P    |
| Rectangular | AML76F10T01P    |

### AML78 PANEL PLUGS

| Description | Catalog Listing |
|-------------|-----------------|
| Square      | AML78CB         |
| Rectangular | AML78FB         |

### DUMMY HOUSING ORDER GUIDE

| Description                  | Catalog Listing |
|------------------------------|-----------------|
| Rectangular (pushbutton)     | AML78F100       |
| Rectangular (lens indicator) | AML78J100       |

\* Order AML51 buttons/lenses for use with dummy housings

### AML79 CONNECTOR BLOCK

This connector block can be used with square 1 and 2 pole AML21 and AML22 switches with .110 x .020 terminals to enable plug-in wiring.

#### AML79CC

\* **NOTE:** Contact Customer Service for minimum quantity required to establish or reinstate a catalog listing

# Honeywell Sensing and Control AML/MML Selection Guide

## AML91/92 Lamps/LEDs\*\*

### AML91 LAMP ORDER GUIDE

| Lamp Type                             | Industry Lamp No. | Voltage | Catalog Listing |
|---------------------------------------|-------------------|---------|-----------------|
| Incandescent<br>T-1-3/4<br>wedge base | 86                | 6.3     | AML91LA86       |
|                                       | 73                | 14.0    | AML91LA73       |
|                                       | 85                | 28.0    | AML91LA85       |

Discount **BE**  
Schedule Qty.: **25** pieces/listing  
Unclass.

Ten piece minimum order quantity for lamps and LEDs.

### AML92 LED ORDER Guide

| LED Color | Quad Chip | Six Chip  |
|-----------|-----------|-----------|
| Red       | AML92ERY  | AML92ERL  |
| Green     | AML92EGY  | AML92EGL  |
| Yellow    | AML92EYY  | AML92EYL  |
| White     | -         | AML92EWL* |

\* For use with white or yellow buttons

\*\* **NOTE:** Contact Customer Service for minimum quantity required to establish or reinstate a catalog listing

# Honeywell Sensing and Control AML/MML Selection Guide

## MML11 Solid state pushbutton switches\*

Example: **MML11KK3AAK**

Solid state pushbutton housing (black), no bezel; PWB terminals; momentary action; 5 VDC, current sinking output, black plunger

Example: **MML11KK3AAKRSDR**

As above, except furnished with black bezel; mounting clips (long sides); red LED, and red lens installed

Discount **BE**

Schedule Qty.: **25** pieces/listing  
Unclass.

### MML11 LED, INCANDESCENT, OR NON-LIGHTED DISPLAY ORDER GUIDE

Catalog listing codes for switch,  
less assembled display options

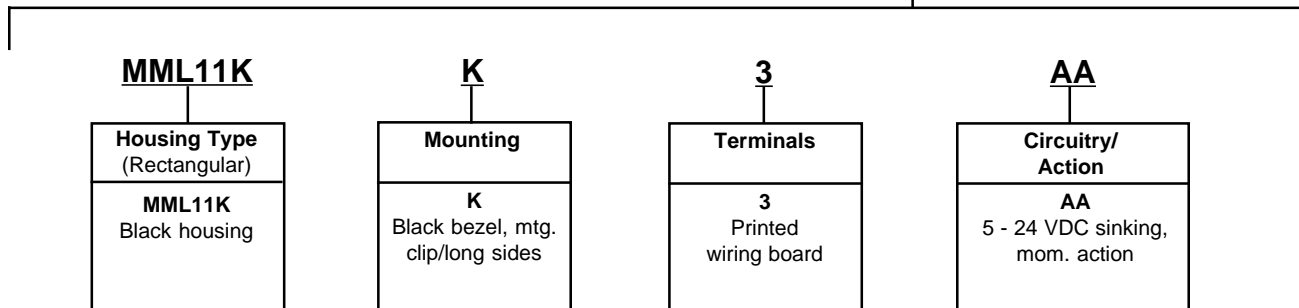

## MML21 Electronic control pushbutton switches\*

Example: **MML21KK3AAK**

Electronic control pushbutton switch; rectangular housing (black); bezel (black); mounting clips on long sides, PWB terminals; 1-pole momentary action, silver contacts, black plunger

Example: **MML21KK3AAKRSDR**

As above, except furnished with red LED and red lens installed

Discount **BE**

Schedule Qty.: **25** pieces/listing  
Unclass.

### MML21 (RECTANGULAR) LED, INCANDESCENT, OR NON-LIGHTED DISPLAY ORDER GUIDE

Catalog listing codes for switch,  
less assembled display options

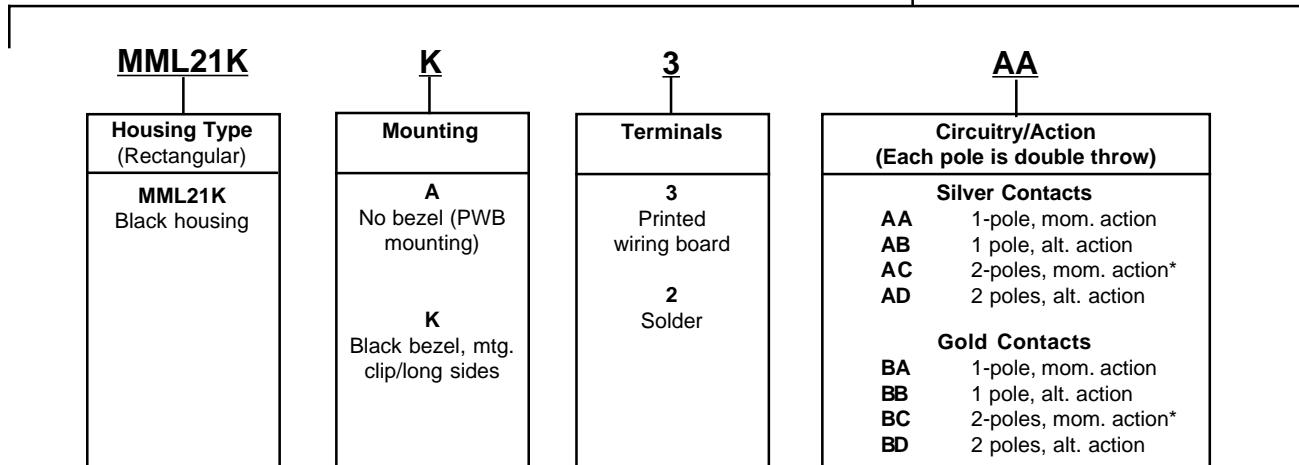

\* Specify **AC** or **BC** for use with **encoded** umbrella style buttons.

\* **NOTE:** Contact Customer Service for minimum quantity required to establish or reinstate a catalog listing

# Honeywell Sensing and Control AML/MML Selection Guide

Order MML11 display options assembled to switch by adding codes below.

| <b>K</b>          | <b>RS</b>  | <b>DR</b>  | <b>Leave this space blank,<br/>if legend not desired</b>  |
|-------------------|--|--|---|
| <b>Plunger</b>    | <b>LED<br/>(Stanley Type)</b>  | <b>Lens</b>  | <b>Legend</b>   |
| <b>K</b><br>Black | <b>XX</b> No LED<br><b>RS</b> Red*<br><b>YS</b> Yellow*<br><b>GS</b> Green*<br><br><small>* Permanently installed.</small> | <b>For LED Display</b><br><b>DR</b> Red<br><b>DY</b> Yellow<br><b>DG</b> Green<br><br><b>For incandescent or non-lighted display</b><br><b>LR</b> Red<br><b>LY</b> Yellow<br><b>LG</b> Green<br><b>LW</b> White<br><b>LK</b> Black | <b>20</b> with legend<br><br>A \$6.00 recurring set up charge per legend. A one-time charge of \$70.00 applies to establish a new graphic legend. |

Order MML21 display options assembled to switch by adding codes below.

| <b>K</b>   | <b>RS</b>  | <b>DR</b>   | <b>Leave this space blank,<br/>if legend not desired</b>   |
|--|--|---|--|
| <b>Std.Plunger (w/o lens)</b>  | <b>LED<br/>(Stanley Type)</b>  | <b>Lens</b>   | <b>Legend</b>  |
| <b>K</b><br>Black<br><br><b>W</b><br>White   | <b>XX</b> No LED<br><b>RS</b> Red*<br><b>YS</b> Yellow*<br><b>GS</b> Green*<br><br><small>* Permanently installed.</small> | <b>XX</b> No lens*<br><b>For LED Display</b><br><b>DR</b> Red<br><b>DY</b> Yellow<br><b>DG</b> Green<br><br><b>For incandescent or non-lighted display</b><br><b>LR</b> Red<br><b>LY</b> Yellow<br><b>LG</b> Green<br><b>LW</b> White<br><b>LK</b> Black<br><br><small>* Enter XX when 1-piece plunger/lens is specified and legending is required.</small> | <b>20</b><br>with legend<br><br>A \$6.00 recurring set up charge per legend. A one-time charge of \$70.00 applies to establish a new graphic legend. |
| <b>1-piece Plunger/Lens Cap Buttons</b>  |  |   |  |
| <b>For LED Display</b><br><b>H</b> Red<br><b>L</b> Yellow<br><b>N</b> Green<br><br><b>For incandescent or non-lighted display</b><br><b>R</b> Red<br><b>Y</b> Yellow<br><b>G</b> Green<br><b>Z</b> Black |  |   |  |

# Honeywell Sensing and Control AML/MML Selection Guide

## MML21 Electronic control pushbutton switches\*

Example: **MML21HR3AAKXXDR**

Electronic control pushbutton switch; square housing (black); bezel (black) and mounting clips; PWB terminals; 1-pole momentary action, silver contacts; black plunger, with red lens installed.

Discount **BE**

Schedule Qty.: **25** pieces/listing

Unclass.

### MML21 (SQUARE) LED, INCANDESCENT, OR NON-LIGHTED DISPLAY ORDER GUIDE

Catalog listing codes for switch,  
less assembled display options

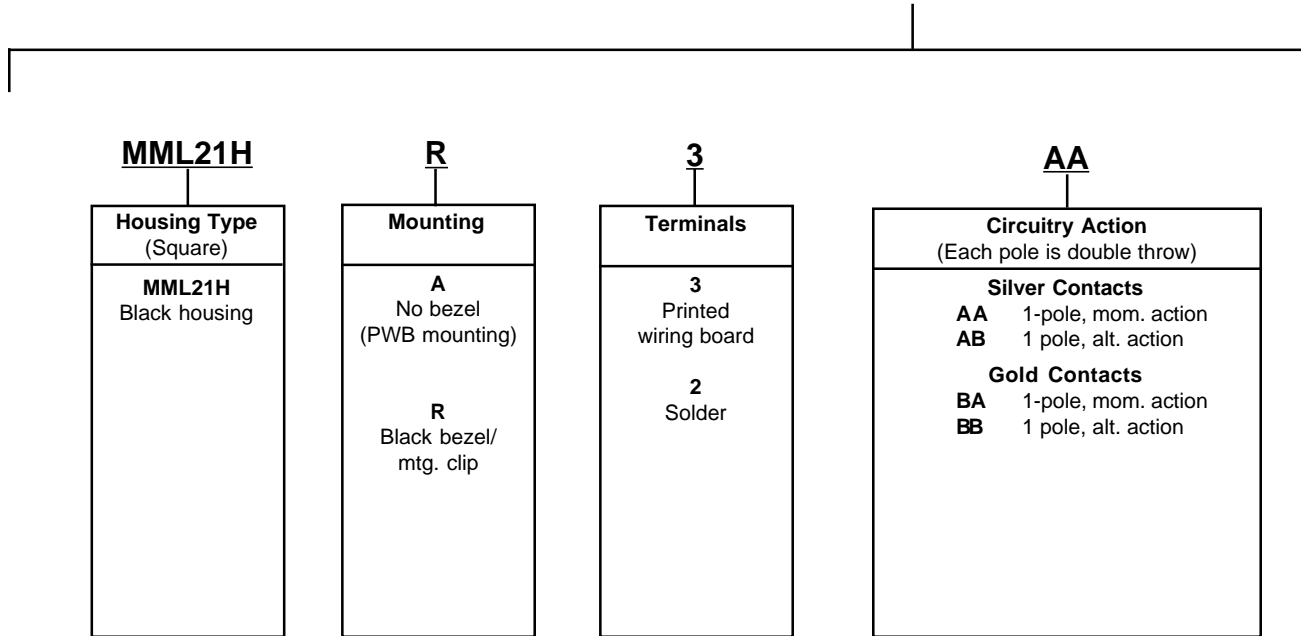

\* **NOTE:** Contact Customer Service for minimum quantity required to establish or reinstate a catalog listing



# Honeywell Sensing and Control AML/MML Selection Guide

Order MML21 display options assembled to switch by adding codes below.

| <b>K</b>                  |  | <b>XX</b>   | <b>DR</b>   | <u>Leave this space blank,<br/>if legend not desired</u>  |
|---------------------------|--|---|---|---|
| Std.Plunger<br>(w/o lens) | 1-piece Plunger/Lens<br>Cap Buttons  | LED   | Lens  | Legend  |
| <b>K</b><br>Black         | <b>For LED Display</b><br><b>H</b> Red<br><b>L</b> Yellow<br><b>N</b> Green<br><br><b>For incandescent or<br/>non-lighted display</b><br><b>R</b> Red<br><b>Y</b> Yellow<br><b>G</b> Green<br><b>Z</b> Black | <b>XX</b> No LED<br><br>LEDs are not permanently<br>installed in square housings<br>by Honeywell Sensing and<br>Control.<br><br>Use the MML93L recep-<br>tacle. | <b>XX</b> No lens<br><b>For LED Display</b><br><b>DR</b> Red<br><b>DY</b> Yellow<br><b>DG</b> Green<br><br><b>For incandescent or<br/>non-lighted display</b><br><b>LR</b> Red<br><b>LY</b> Yellow<br><b>LG</b> Green<br><b>LW</b> White<br><b>LK</b> Black | <b>20</b><br>with legend<br><br>A \$6.00 recurring set<br>up charge per<br>legend. A one-time<br>charge of \$70.00<br>applies to establish a<br>new graphic legend. |

# Honeywell Sensing and Control AML/MML Selection Guide

## MML24 Electronic control rocker switches\*\*

Example: **MML24KA3AA01HDRXX**

Electronic control rocker switch with black housing, printed wiring board terminals; one-pole, silver contacts; 2-position, maintained action; one-circuit ON in each position; black rocker, red lens for LED display in Side 1 and no lens in Side 2.

Discount **BE**

Schedule Qty.: **25** pieces/listing

Unclass.

### MML24 LED, INCANDESCENT, OR NON-LIGHTED DISPLAY ORDER GUIDE



\* Lighted switches with solder terminals require MML93R receptacle to install lamps or LEDs.

\*\* **NOTE:** Contact Customer Service for minimum quantity required to establish or reinstate a catalog listing

# Honeywell Sensing and Control AML/MML Selection Guide

|               |  |   |   |  |
|---------------|--|---|---|--|
| <b>01</b>     | <b>H</b>   | <b>DRXX</b>   |   | <u>Leave this space blank,<br/>if legend not desired</u>   |
| <b>Action</b> | <b>Rocker</b>  | <b>Lens<br/>(Side 1)</b>  | <b>Lens<br/>(Side 2)</b>  | <b>Legend</b>  |
| No Charge     | <p style="text-align: center;"><b>B</b><br/>Black rocker</p> <p style="text-align: center;"><b>H</b><br/>Black rocker,<br/>one lens*</p> <p style="text-align: center;"><b>F</b><br/>White rocker,<br/>one lens*</p> | <p><b>XX</b> None</p> <p>LED display:      Incand. display:</p> <p><b>DR</b> Red          <b>LR</b> Red</p> <p><b>DY</b> Yellow      <b>LY</b> Yellow</p> <p><b>DG</b> Green        <b>LG</b> Green</p> <p>                         <b>LW</b> White</p> | <p><b>XX</b> None</p> <p>LED display:      Incand. display:</p> <p><b>DR</b> Red          <b>LR</b> Red</p> <p><b>DY</b> Yellow      <b>LY</b> Yellow</p> <p><b>DG</b> Green        <b>LG</b> Green</p> <p>                         <b>LW</b> White</p> | <p><b>20</b><br/>with legend</p> <p>A \$6.00 recurring set up charge per legend. A one-time charge of \$70.00 applies to establish a new graphic legend.</p> |

\* Lighted switches with solder terminals require MML93R receptacle to install lamps or LEDs.

# Honeywell Sensing and Control AML/MML Selection Guide

## MML46 Indicators/flush mount\*\*

Example: **MML46KA3**

Indicator housing, rectangular (black); no bezel; support terminals

Example: **MML46KA3RSXXDR20**

As above, except furnished with red LED and red lens, with legend

Discount **BE**

Schedule Qty.: **25** pieces/listing  
Unclass.

### MML46 LED OR INCANDESCENT DISPLAY ORDER GUIDE

| <b>MML46K</b>   | <b>A</b>   |  | <b>3</b>   |
|---|--|--|--|
| Housing Type  | Mounting Rectangular   | Mounting Square  | Support Posts  |
| <p><b>MML46K Rectangular</b><br/>(1 or 2 LEDs or incand. lamps)<br/>Black housing</p> <p><b>MML46H Square</b><br/>(1 LED or incand. lamp)<br/>Black housing</p> | <p><b>A</b><br/>No bezel<br/>(PWB mounting)</p> <p><b>K</b><br/>Black bezel,<br/>mtg. clip/<br/>long sides</p> | <p><b>A</b><br/>No bezel<br/>(PWB mounting)</p> <p><b>R</b><br/>Black bezel,<br/>mtg. clip/<br/>long sides</p> | <p><b>3</b><br/>PWB</p> <p><b>2</b><br/>Solder**<br/>No charge</p> <p><b>0</b><br/>None<br/>(for snap-in and strip/matrix mount)<br/>No charge</p> |

\* LEDs are not permanently installed in square housings by Honeywell Sensing and Control.

\*\* Rectangular housings only

\*\* **NOTE:** Contact Customer Service for minimum quantity required to establish or reinstate a catalog listing

## MML51 Button lenses/incandescent or non-lighted display\*\*

### MML51 ORDER GUIDE

| <b>MML51E</b>   | <b>20</b>   | <b>R</b>  |
|---|---|---|
| Lens Type   | Display/Legend Type   | Color   |
| <p><b>Rectangular MML51E</b><br/>Switch lens</p> <p><b>MML51G*</b><br/>Indicator lens</p> | <p><b>10</b><br/>No legend</p> <p><b>20</b><br/>With Legend</p> <p>A \$6.00 recurring set up charge per legend. A one-time charge of \$70.00 applies to establish a new graphic legend.</p> | <p><b>R</b><br/>Red</p> <p><b>Y</b><br/>Yellow</p> <p><b>G</b><br/>Green</p> <p><b>W</b><br/>White</p> <p><b>K</b><br/>Black (opaque)</p> |

Discount **BE**  
Schedule Qty.: **25** pieces/listing  
Unclass.

Five piece minimum order quantity for buttons

Example:  
**MML51E20R**  
Incandescent or non-lighted display switch lens; red transmitted color, with legend. Unclassified.

\*\* **NOTE:** Contact Customer Service for minimum quantity required to establish or reinstate a catalog listing

\* Use MML51E with MML41 rectangular pushbutton style indicators

# Honeywell Sensing and Control AML/MML Selection Guide

Order MML46 display options assembled to indicator by adding codes below.

**Leave this space blank,  
if legend not desired**

| <b>RSXX</b>   | <b>DR</b>  | <b>20</b>  |
|---|--|--|
| <b>LED</b><br>(Stanley type)  | <b>Lens</b>  | <b>Legend</b>  |
| Available in rectangular housings only<br><b>XX</b> No LED<br><br>One LED*            Two LEDs*<br><b>RSXX</b> Red <b>RSRS</b> Red<br><b>YSXX</b> Yellow <b>YSYS</b> Yellow<br><b>GSXX</b> Green <b>GSGS</b> Green<br><br>* Permanently installed | For LED display<br><br><b>DR</b> Red<br><b>DY</b> Yellow<br><b>DG</b> Green<br><br>For incandescent or non-lighted display<br><b>LR</b> Red<br><b>LY</b> Yellow<br><b>LG</b> Green<br><b>LW</b> White<br><b>LK</b> Black | <b>20</b><br>with legend<br><br>A \$6.00 recurring set up charge per legend. A one-time charge of \$70.00 applies to establish a new graphic legend. |

Since square housings accept only one LED, only a two-character LED code is necessary.  
For example:  
MML46HR0XXDY or  
MML46HR0RSDY

\* When ordering incandescent or non-lighted display, LED field must be XXXX.

## MML52 Button lenses/LED\*\*

### MML52 ORDER GUIDE

| <b>MML52G</b>   | <b>10</b>   | <b>Y</b>  |  |
|---|---|---|--|
| <b>Lens Type</b>  | <b>Display/Legend Type</b>  | <b>Color/Illumination</b>   |  |
| <b>Rectangular</b><br><b>MML52E</b><br>Switch lens<br>LED display<br><br><b>MML52G*</b><br>Indicator lens | <b>Trans. Color</b><br><b>10</b><br>No legend<br><br><b>20</b><br>With Legend<br><br>A \$6.00 recurring set up charge per legend. A one-time charge of \$70.00 applies to establish a new graphic legend. | <b>LED Display</b><br><b>R</b><br>Red<br><br><b>Y</b><br>Yellow<br><br><b>G</b><br>Green<br><br><b>C</b><br>Clear | Discount <b>BE</b><br>Schedule Qty.: <b>25</b> pieces/listing<br>Unclass.<br><br>Five piece minimum order quantity for buttons<br><br>Example:<br><b>MML52G10Y</b><br>LED display indicator lens; yellow transmitted color, no legend. Unclassified.<br><br><b>** NOTE:</b> Contact Customer Service for minimum quantity required to establish or reinstate a catalog listing |

\* Use MML52E with MML41 rectangular pushbutton style indicators

# Honeywell Sensing and Control AML/MML Selection Guide

## MML72 Bezels/mounting clips\*

Discount **BE**  
 Schedule Qty.: 25 pieces/listing  
 Unclass.

Ten piece minimum order quantity

Example:  
**MML72EEK**  
 Black switch bezel, mounting clips on long sides.

\* **NOTE:** Contact Customer Service for minimum quantity required to establish or reinstate a catalog listing

## MML92 LEDs\*\*\*

Discount **BE**  
 Schedule Qty.: 25 pieces/listing  
 Unclass.

### MML92 ORDER GUIDE

LEDs should be the same color as the lenses they illuminate. They are packed 10 per listing, including stand-off spacers for use when solder terminating to a printed wiring board.

| LED Type | Use to Illuminate                          | Catalog Listing | LED Color | Forward Characteristics Typ. @ 20mA | Max.                                    | LED Manufacturers' Part Numbers         |
|----------|--|-----------------|-----------|-------------------------------------|---|---|
| T-1-3/4  | Rectangular button lens                    | MML92ERS        | Red       | 1.7V                                | <b>Stanley:</b><br>2.0V<br>2.5V<br>2.5V | ESBR5633                                |
|          |  | MML92EGS        | Green     | 2.1V                                |   | ESBG5633                                |
|          |  | MML92EYS        | Yellow    | 2.1V                                |   | ESAY5633                                |
| T-1      | Square button lens and MML24 rocker lens** | MML92HGS        | Green     | 2.1V                                | <b>Stanley:</b><br>2.5V                 | ESPY3901                                |
|          |  | MML92HRH        | Red       | 2.2V*                               |   | <b>Hewlett Packard:</b><br>3.0V<br>3.0V |
|          |  | MML92HGH        | Green     | 2.3V*                               | HLMP-1540                               |   |

Long lead: Anode (+), Short lead: Cathode (-).

\* @ 25 mA.

\*\* Also rectangular button lens, when used with MML93J solder terminal receptacle.

\*\*\* **NOTE:** Contact Customer Service for minimum quantity required to establish or reinstate a catalog listing

# Honeywell Sensing and Control AML/MML Selection Guide

## MML93 LED/Incandescent lamp receptacles\*

Discount BE  
Schedule Qty.: 25 pieces/listing  
Unclass.

### MML93 RECEPTACLE ORDER GUIDE

These receptacles do not include LEDs or lamps.

| Receptacle Type      | Catalog Listing | Mates With                  | Use to Illuminate                               |
|----------------------|-----------------|-----------------------------|---|
| Printed Wiring Board | MML93K          | T-1 3/4 LED                 | Rectangular button lens or umbrella button lens |
|                      | MML93G          | T-1 LED or bi-pin lamp      | Square button lens or MML24 rocker lens         |
| Solder Terminal      | MML93J          | T-1 LED or bi-pin lamp      | Rectangular button lens                         |
| Solder               | MML93L          | T-1 LED or unbased T-1 lamp | Square button lens                              |
|                      | MML93R          | T-1 LED or unbased T-1 lamp | MML24 rocker lens                               |

\* **NOTE:** Contact Customer Service for minimum quantity required to establish or reinstate a catalog listing



Компания «ЭлектроПласт» предлагает заключение долгосрочных отношений при поставках импортных электронных компонентов на взаимовыгодных условиях!

Наши преимущества:

- Оперативные поставки широкого спектра электронных компонентов отечественного и импортного производства напрямую от производителей и с крупнейших мировых складов;
- Поставка более 17-ти миллионов наименований электронных компонентов;
- Поставка сложных, дефицитных, либо снятых с производства позиций;
- Оперативные сроки поставки под заказ (от 5 рабочих дней);
- Экспресс доставка в любую точку России;
- Техническая поддержка проекта, помощь в подборе аналогов, поставка прототипов;
- Система менеджмента качества сертифицирована по Международному стандарту ISO 9001;
- Лицензия ФСБ на осуществление работ с использованием сведений, составляющих государственную тайну;
- Поставка специализированных компонентов (Xilinx, Altera, Analog Devices, Intersil, Interpoint, Microsemi, Aeroflex, Peregrine, Syfer, Eurofarad, Texas Instrument, Miteq, Cobham, E2V, MA-COM, Hittite, Mini-Circuits, General Dynamics и др.);

Помимо этого, одним из направлений компании «ЭлектроПласт» является направление «Источники питания». Мы предлагаем Вам помощь Конструкторского отдела:

- Подбор оптимального решения, техническое обоснование при выборе компонента;
- Подбор аналогов;
- Консультации по применению компонента;
- Поставка образцов и прототипов;
- Техническая поддержка проекта;
- Защита от снятия компонента с производства.



#### Как с нами связаться

**Телефон:** 8 (812) 309 58 32 (многоканальный)

**Факс:** 8 (812) 320-02-42

**Электронная почта:** [org@eplast1.ru](mailto:org@eplast1.ru)

**Адрес:** 198099, г. Санкт-Петербург, ул. Калинина, дом 2, корпус 4, литера А.