

## Overview

The T550 axial leaded and T555 surface mount polymer hermetically sealed (PHS) devices are tantalum capacitors with a Ta anode and Ta<sub>2</sub>O<sub>5</sub> dielectric. A conductive organic polymer replaces the traditionally used MnO<sub>2</sub> or wet electrolyte as the cathode plate of the capacitor. This results in very low ESR and improved capacitance retention at high frequency and low temperature. The PHS device also exhibits a benign failure mode, which eliminates the case breach that can occur in wet tantalum capacitors. Additionally, this part may be operated at voltages up to 80% of rated voltage, with equivalent or better reliability than traditional MnO<sub>2</sub> or wet tantalum capacitors operated at 50% of rated voltage.

PHS capacitors also offer higher ripple current handling capability and a lower ESR range than wet tantalums. With reduced ESR and enhanced capacitance retention at higher frequencies and low temperatures, these parts provide the highest total capacitance and the most economical solution for high power applications, all within an approximately 25% lighter package than the equivalent wet tantalum capacitor.

## Benefits

- Includes F-Tech anode which eliminates hidden defects in the dielectric
- 100% simulated breakdown screening
- Maximum operating temperature of +105°C
- DLA drawing 13030 qualified parts available
- Polymer cathode technology
- Extremely low ESR
- High frequency and low temperature capacitance retention
- 100% constant voltage conditioning (240 hours)
- 100% surge current tested
- Volumetrically efficient
- Non-ignition failure mode
- Approximately 25% lighter than equivalent wet tantalum
- T550 case dimensions equivalent to MIL-PRF-39006/22/25/30/31
- T555 surface mount design (see dimensions diagram)

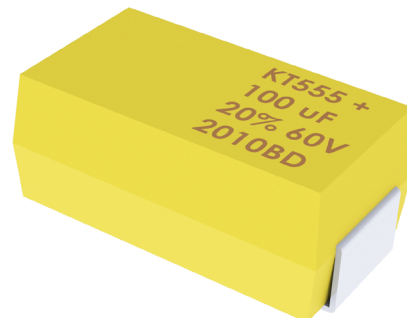

## Applications

Typical applications include high voltage power management, such as buck/boost converters, filtering, hold-up capacitors, and other high ripple current applications.

## Ordering Information

T	550	B	107	M	025	A	T	4251	
Capacitor Class	Series	Case Size	Capacitance Code (pF)	Capacitance Tolerance	Rated Voltage (VDC)	Product Level	Termination Finish	Surge Option**	Packaging**
T = Tantalum	550 = Axial Leaded PHS 555 = Surface Mount PHS	B	First two digits represent significant figures. Third digit specifies number of zeros.	K = ±10% M = ±20%	006 = 6.3 008 = 8 010 = 10 015 = 15 025 = 25 030 = 30 035 = 35 040 = 40 050 = 50 060 = 60 075 = 75 100 = 100	A = N/A B* = DLA 13030 standard reliability T* = DLA 13030 high reliability E* = DLA 13030 "B" level equivalent for T termination F* = DLA 13030 "T" level equivalent for T termination	T = 100% tin (Sn)-plated H = Tin/lead (SnPb) solder coated (5% Pb minimum)	Blank = 25°C ±5°C, 10 cycles, after constant voltage conditioning (KEMET standard) 4251 = 10 cycles, -55°C and +85°C after constant voltage conditioning 4252 = 10 cycles, -55°C and +85°C before constant voltage conditioning	Blank = Bulk/Sleeved 0100 = Bulk/Unsleeved 7200 = Tape & Reel/Sleeved 7293 = Ammo/Sleeved 7443 = Ammo/Sleeved

\* Only available on select parts. Refer to part number table for details.

\*\* Only for T550 (Surge options/Packaging)

## Ordering Information – DLA

13030	-01	K	A	S	L	B
Drawing Number	Dash Number	Capacitance Tolerance	Surge Current Testing	Insulation	Lead Length	Product Level
See Part Number Table	See Part Number Table	K = ±10% M = ±20%	A = +25°C ±5°C, 10 cycles, after constant voltage conditioning (KEMET standard) B = -55°C, -5°C, +0°C and +85°C ±5°C after constant voltage conditioning. C = -55°C, -5°C, +0°C and +85°C ±5°C before constant voltage conditioning.	S = Sleeved U = Unsleeved	L = 1.50 inches (standard)	B = Standard reliability T = High reliability

\* Standard terminations for DLA part numbers is "H" (SnPb).

## Performance Characteristics

Item	Performance Characteristics
Operating Temperature	-55°C to 105°C
Rated Capacitance Range	20 – 680 µF at 120 Hz/25°C *
Capacitance Tolerance	K tolerance (±10%), M tolerance (±20%)
Rated Voltage Range	6.3 – 100 V
DF (120 Hz at 25°C)	Refer to Part Number Electrical Specification Table
ESR (100 kHz at 25°C)	Refer to Part Number Electrical Specification Table
Leakage Current	Refer to Part Number Electrical Specification Table (rated voltage up to +85°C and 78% of rated voltage applied at 105°C)
Packaging	T550 according to MIL-PRF-39006, T555 bulk

KEMET does not recommend storage above 85°C.

\* Additional case sizes and capacitance/voltage are under development.

## Qualification - T550

Test Performed	Method Reference	Test Conditions
<b>Reliability and Environmental Tests</b>		
AC Ripple Life at 85°C	MIL-PRF-39006	85°C, 40 kHz ripple current, 2,000 hours
85°C Life	KEMET Standard	85°C, rated voltage, 2,000 hours
105°C Life	KEMET Standard	105°C, 0.78 x rated voltage, 2,000 hours
Surge Voltage	MIL-PRF-39006	85°C, 1.15 x rated voltage, 1,000 cycles, except delta cap shall be +10%/-20%
Surge Current	MIL-PRF-39003	+25 °C, 10 cycles (Option A), Option B available
Low Temperature Storage	MIL-PRF-39006	-62°C for 72 hours followed by 1 hour at 125°C
Reverse Voltage	KEMET Catalog	1 V for 8 hours maximum at 25°C, 1 V for 2 hours maximum at 70°C
<b>Physical, Mechanical and Process Tests</b>		
Visual and Mechanical Examination (Internal and External)	MIL-PRF-39006	Case dimensions, marking
Terminal Strength	MIL-PRF-39006	Pull test and wire lead bend test
Resistance to Solvents	MIL-PRF-39006	Immersion in (3) solvents
Resistance to Soldering Heat	MIL-PRF-39006	Immersed to within 0.05 inch of capacitor body
Solderability	MIL-PRF-39003	Depth of insertion in flux and solder to within 0.125 inch ±0.025 inch (3.18 mm ± 0.64 mm) from end of case and from the point of "clean lead" emerging from the seal eyelet.
Shock and Vibration	MIL-STD-202, Methods 213, 204	Shock Method 213, Condition I, 100 G peak, Vibration Method 204, Condition D, 20 G peak
Barometric Pressure (Reduced)	MIL-PRF-39006	150,000 feet for 5 minutes, voltage applied for 1 minute
Salt Atmosphere (Corrosion)	MIL-PRF-39006	Subjected to fine mist of salt solution
Moisture Resistance	MIL-PRF-39006	65°C at 6 V
Dielectric Withstanding Voltage	MIL-PRF-39006	2,000 VDC, 60 seconds, sleeving examined for evidence of breakdown
Insulation Resistance	MIL-PRF-39003	500 VDC, 1 minute, insulation resistance not less than 1,000 MΩ
<b>Electrical Characterization</b>		
Temperature Stability	Reference MIL-PRF-39006	-55°C to 105°C
Frequency Scan	KEMET Standard	Impedance, ESR and capacitance versus frequency

## Qualification – DLA Approval Inspection – Only for T550

Inspection	Test Name	DLA Requirement Paragraph	SS/Lot
Group I	Shock (specified pulse) <sup>1</sup>	3.3.4	6 per case size
	Vibration, high frequency <sup>1</sup>	3.3.5	
	Thermal shock	3.3.6	
	Salt atmosphere	3.3.7	
Group II	Solderability	3.3.8	12
	Terminal strength	3.3.9	
	Surge voltage <sup>2</sup>	3.3.10	
	Moisture resistance	3.3.11	
	Dielectric withstanding voltage	3.3.12	
	Insulation resistance	3.3.13	
Group III	Low temperature (storage)	3.3.14	13
	Stability at low and high temperatures	3.3.15	
Group IV	Reverse voltage	3.3.23	12 per condition
Group V	Life at 85°C	3.3.16	102
Group VI	AC ripple life at 85°C	3.3.18	8 per case size
Group VI	Life at 105°C	3.3.17	40
	Barometric pressure	3.3.20	
Group VII	Resistance to solvents	3.3.21	6
	Resistance to soldering heat	3.3.22	

<sup>1</sup> No failures for mechanical shock or vibration tests shall be permitted.

<sup>2</sup> Surge voltage change in capacitance limits are wider than those in some subsequent tests.

It may be necessary to perform initial measurements again, prior to the individual tests of Group II.

### Product Level:

Inspection of product for delivery shall consist of:

B level	Group A inspection specified in Drawing 13030
T level	Group A and group B inspections specified in Drawing 13030

## Qualification - T555

Test Performed	Method Reference	Test Conditions
Reliability and Environmental Tests		
105°C Life	KEMET Standard	105°C, 0.78 x rated voltage, 2,000 hours
Surge Voltage	MIL-PRF-39006	85°C, 1.15 x rated voltage, 1,000 cycles, except delta cap shall be +10%/–20%
Physical, Mechanical and Process Tests		
Visual and Mechanical Examination (Internal and External)	MIL-PRF-39003	Case dimensions, marking
Terminal Strength	MIL-PRF-39006	Pull test and wire lead bend test
Resistance to Solvents	MIL-PRF-39006	Immersion in (3) solvents
Resistance to Soldering Heat	MIL-PRF-39006	Immersed to within 0.05 inch of capacitor body
Solderability	MIL-PRF-39006	Depth of insertion in flux and solder to within 0.062 inch of welded joint
Shock and Vibration	MIL-STD-202, Methods 213, 204	Shock Method 213, Condition I, 100 g peak, Vibration Method 204, Condition D, 20 g peak
Electrical Characterization		
Temperature Stability	Reference MIL-PRF-39006	–55°C to 105°C

## Environmental Compliance

Epoxy compliant with UL 94 V–0.

## Electrical Characteristics

### ESR vs. Frequency



### Capacitance vs. Frequency



## Dimensions – Inches (Millimeters)

### T550

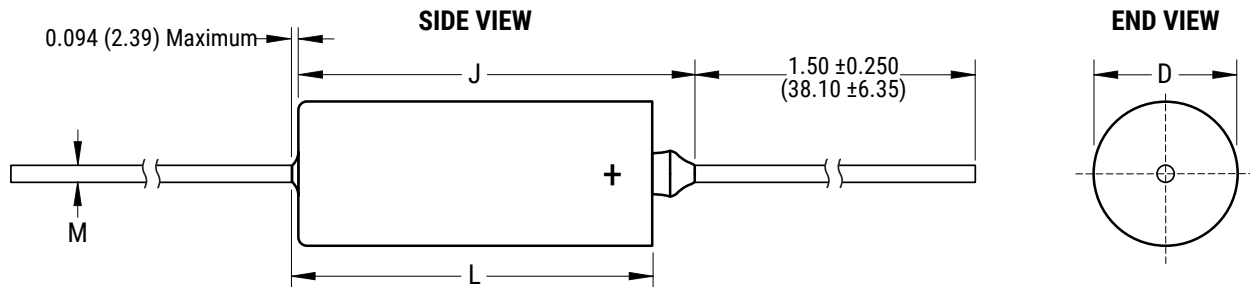

Case Code	Case Size	Uninsulated Case				Insulated Case	
	MIL-PRF-39006	L $\pm 0.031$ (0.79)	D $+0.016$ (0.41) $-0.015$ (0.38)	M $\pm 0.002$ (0.05)	J maximum	D $+0.016$ (0.41) $-0.015$ (0.38)	L $\pm 0.031$ (0.79)
B	T2	0.650 (16.51)	0.279 (7.09)	0.025 (0.64)	0.822 (20.88)	0.289 (7.34)	0.686 (17.42)

## Dimensions – Millimeters

### T555

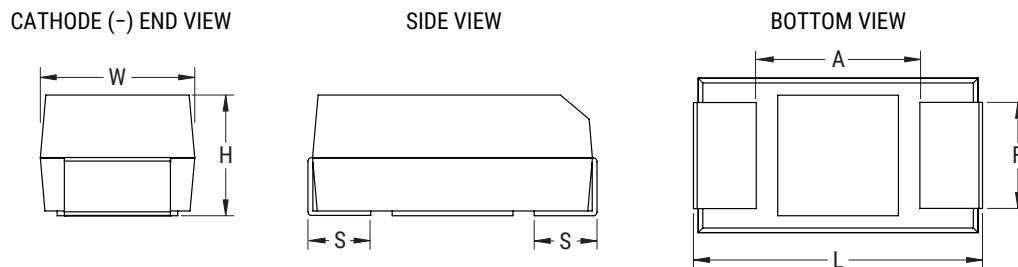

Case Code						Weight (g)
	L $\pm 0.5$	W $\pm 0.5$	H $\pm 0.5$	F $\pm 0.5$	S $\pm 0.3$	Average
B Surface mount	24.5	8.5	9.1	4.2	3.0	5.54

**Table 1A – Ratings & Part Number Reference**

Rated Voltage	Rated Capacitance	Case Size	KEMET Part Number	DLA Drawing Number	DC Leakage	DF	Maximum ESR	Ripple Current
(V) 85°C	µF	KEMET/EIA	(See below for part options)	(See below for part options)	µA at 25°C Maximum/ 5 Minutes	% at 25°C 120 Hz Max	mΩ at 25°C 100 kHz	mArms at 85°C/40 kHz
6.3	140	B	T550B147(1)006A(3)	N/A	6.3	5.0	120	1,510
8	220	B	T550B227(1)008A(3)	N/A	13.2	5.0	120	1,510
8	680	B	T550B687(1)008A(3)	N/A	40.8	5.0	90	1750
10	100	B	T550B107(1)010A(3)	N/A	7.5	5.0	140	1400
10	180	B	T550B187(1)010A(3)	N/A	13.5	5.0	110	1580
10	560	B	T550B567(1)010A(3)	N/A	42.0	5.0	90	1750
15	70	B	T550B706(1)015A(3)	N/A	7.9	5.0	140	1400
15	120	B	T550B127(1)015A(3)	N/A	13.5	5.0	110	1580
15	390	B	T550B397(1)015A(3)	N/A	43.9	5.0	90	1750
25	50	B	T550B506(1)025A(3)	N/A	9.4	5.0	170	1275
25	100	B	T550B107(1)025(2)(3)	13030-01(1)(4)(5)L(6)	18.8	5.0	190	1,200
25	100	B	T550B107(1)025(7)T	N/A	18.8	5.0	190	1,200
30	40	B	T550B406(1)030A(3)	N/A	9.0	5.0	170	1,275
30	68	B	T550B686(1)030A(3)	N/A	15.3	5.0	140	1,400
35	330	B	T550B337(1)035A(3)	N/A	86.6	10.0	180	1,240
40	100	B	T550B107(1)040(2)(3)	13030-02(1)(4)(5)L(6)	30.0	5.0	150	1,350
40	100	B	T550B107(1)040(7)T	N/A	30.0	5.0	150	1,350
40	120	B	T550B127(1)040(2)(3)	13030-03(1)(4)(5)L(6)	36.0	5.0	120	1,510
40	120	B	T550B127(1)040(7)T	N/A	36.0	5.0	120	1,510
50	25	B	T550B256(1)050A(3)	N/A	9.4	5.0	170	1,275
50	47	B	T550B476(1)050A(3)	N/A	17.6	5.0	150	1,350
50	100	B	T550B107(1)050(2)(3)	13030-04(1)(4)(5)L(6)	37.5	5.0	130	1,450
50	100	B	T550B107(1)050(7)T	N/A	37.5	5.0	130	1,450
50	120	B	T550B127(1)050(2)(3)	13030-05(1)(4)(5)L(6)	45.0	5.0	90	1,750
50	120	B	T550B127(1)050(7)T	N/A	45.0	5.0	90	1,750
60	20	B	T550B206(1)060A(3)	N/A	9.0	5.0	200	1,175
60	39	B	T550B396(1)060A(3)	N/A	17.6	5.0	160	1,310
60	100	B	T550B107(1)060(2)(3)	13030-06(1)(4)(5)L(6)	45.0	5.0	100	1,660
60	100	B	T550B107(1)060(7)T	N/A	45.0	5.0	100	1,660
75	75	B	T550B756(1)075(2)(3)	13030-07(1)(4)(5)L(6)	42.2	5.0	110	1,580
75	75	B	T550B756(1)075(7)T	N/A	42.2	5.0	110	1,580
100	25	B	T550B256(1)100(2)(3)	13030-08(1)(4)(5)L(6)	18.8	5.0	190	1,200
100	25	B	T550B256(1)100(7)T	N/A	18.8	5.0	190	1,200

(1) To complete KEMET part number, insert M for ±20% or K for ±10%. Designates capacitance tolerance.

(2) To complete KEMET part number, insert A = N/A, B = standard reliability, or T = high reliability.

(3) To complete KEMET part number, insert T = 100% matte tin (Sn)-plated, H = standard solder coated (SnPb 5% Pb minimum). Designates termination finish.

(4) To complete the DLA PIN number, insert the surge current testing option, A = 25°C after voltage aging, B = -55°C +0°C and +85°C after voltage aging or C = -55°C +0°C and +85°C before voltage aging.

(5) To complete the DLA PIN number, insert the insulation option. S = Sleeved, U = Unseleaved.

(6) To complete the DLA PIN number, insert the product level option. B = standard reliability or T = high reliability.

(7) To complete KEMET part number, insert E = DLA "B" level equivalent, or F = DLA "T" level equivalent. Designates product level  
Refer to Ordering Information for additional detail.

Higher voltage ratings and tighter tolerance product including ESR may be substituted within the same size at KEMET's option. Voltage substitution will be marked with the higher voltage rating. The 85°C 40 kHz ripple limit is based on the maximum allowed power at 85°C and the maximum expected ESR at 40 kHz. For this calculation, the 100 kHz ESR limit is multiplied by a factor of 1.3 to account for the frequency dependence of ESR.



**Table 1B – Ratings & Part Number Reference**

Rated Voltage	Rated Capacitance	Case Size	KEMET Part Number	DC Leakage	DF	Maximum ESR	Ripple Current
(V) 85°C	µF	KEMET/EIA	(See below for part options)	µA at 25°C Maximum/ 5 Minutes	% at 25°C 120 Hz Max	mΩ at 25°C 100 kHz	mArms at 85°C/40 kHz
6.3	140	B	T555B147(1)006A(3)	6.3	5.0	120	1,510
8	220	B	T555B227(1)008A(3)	13.2	5.0	120	1,510
8	680	B	T555B687(1)008A(3)	40.8	5.0	90	1,750
10	100	B	T555B107(1)010A(3)	7.5	5.0	140	1,400
10	180	B	T555B187(1)010A(3)	13.5	5.0	110	1,580
10	560	B	T555B567(1)010A(3)	42.0	5.0	90	1,750
15	70	B	T555B706(1)015A(3)	7.9	5.0	140	1,400
15	120	B	T555B127(1)015A(3)	13.5	5.0	110	1,580
15	390	B	T555B397(1)015A(3)	43.9	5.0	90	1,750
25	50	B	T555B506(1)025A(3)	9.4	5.0	170	1,275
25	100	B	T555B107(1)025A(3)	18.8	5.0	190	1,200
30	40	B	T555B406(1)030A(3)	9.0	5.0	170	1,275
30	68	B	T555B686(1)030A(3)	15.3	5.0	140	1,400
35	330	B	T555B337(1)035A(3)	86.6	10.0	180	1,240
40	100	B	T555B107(1)040A(3)	30.0	5.0	150	1,350
40	120	B	T555B127(1)040A(3)	36.0	5.0	120	1,510
50	25	B	T555B256(1)050A(3)	9.4	5.0	170	1,275
50	47	B	T555B476(1)050A(3)	17.6	5.0	150	1,350
50	100	B	T555B107(1)050A(3)	37.5	5.0	130	1,450
50	120	B	T555B127(1)050A(3)	45.0	5.0	90	1,750
60	20	B	T555B206(1)060A(3)	9.0	5.0	200	1,175
60	39	B	T555B396(1)060A(3)	17.6	5.0	160	1,310
60	100	B	T555B107(1)060A(3)	45.0	5.0	100	1,660
75	75	B	T555B756(1)075A(3)	42.2	5.0	110	1,580
100	25	B	T555B256(1)100A(3)	18.8	5.0	190	1,200

(1) To complete KEMET part number, insert M for ±20% or K for ±10%. Designates capacitance tolerance.

(3) To complete KEMET part number, insert T = 100% Matte Tin (Sn)-plated, H = Standard Solder coated (SnPb 5% Pb minimum). Designates termination finish.

Refer to Ordering Information for additional detail.

Higher voltage ratings and tighter tolerance product including ESR may be substituted within the same size at KEMET's option. Voltage substitution will be marked with the higher voltage rating. The 85°C 40 kHz ripple limit is based on the maximum allowed power at 85°C and the maximum expected ESR at 40 kHz. For this calculation, the 100 kHz ESR limit is multiplied by a factor of 1.3 to account for the frequency dependence of ESR.

## Recommended Voltage Derating Guidelines

	-55°C to 85°C	85°C to 105°C
% Change in working DC voltage with temperature	$V_R$	78% of $V_R$
Recommended maximum application voltage (as % of rated voltage)	80% of $V_R$	63% of $V_R$



## Ripple Current/Ripple Voltage

Permissible AC ripple voltage and current are related to equivalent series resistance (ESR) and the power dissipation capabilities of the device. Permissible AC ripple voltage that may be applied is limited by two criteria:

1. The positive peak AC voltage plus the DC bias voltage, if any, must not exceed the DC voltage rating of the capacitor.
2. The negative peak AC voltage in combination with bias voltage, if any, must not exceed the allowable limits specified for reverse voltage.

The maximum power dissipation by case size can be determined using the below left table. The maximum power dissipation rating stated in the table must be reduced with increasing environmental operating temperatures. Refer to the below right table for temperature compensation requirements.

Case Code		Maximum Power Dissipation ( $P_{max}$ ) mWatts at 25°C with +60°C Rise
KEMET	MIL-PRF-39006/22/ 25/30/31 Case size	
B*	T2	715

\* Applies to TH and SMD

Temperature Compensation Multipliers for Maximum Power Dissipation ( $P_{max}$ )		
$T \leq 45^\circ\text{C}$	$45^\circ\text{C} < T \leq 85^\circ\text{C}$	$85^\circ\text{C} < T \leq 105^\circ\text{C}$
1.00	0.70	0.10

T = Environmental temperature

Using the  $P_{max}$  of the device, the maximum allowable rms ripple current or voltage may be determined.

$$I(max) = \sqrt{P_{max}/R}$$

$$E(max) = Z \sqrt{P_{max}/R}$$

I = rms ripple current (amperes)

E = rms ripple voltage (volts)

$P_{max}$  = maximum power dissipation (watts)

R = ESR at specified frequency (ohms)

Z = Impedance at specified frequency (ohms)

The maximum power dissipation rating must be reduced with increasing environmental operating temperatures. Refer to the Temperature Compensation Multiplier table for details.

## Reverse Voltage

Solid tantalum polymer capacitors are polar devices and may be permanently damaged or destroyed if connected with the wrong polarity. A small reverse voltage is permissible for time periods per the below table. KEMET can offer lower capacitance in this voltage with higher reverse voltage capability. In addition, we continue to improve our capability for this characteristic.

Temperature	Permissible Reverse Voltage
25°C	1 V for 8 hours maximum
70°C	1 V for 2 hours maximum

**Table 2 – Land Dimensions/Courtyard**

KEMET	Metric Size Code	Density Level A: Maximum (Most) Land Protrusion (mm)					Density Level B: Median (Nominal) Land Protrusion (mm)					Density Level C: Minimum (Least) Land Protrusion (mm)						
		Case	EIA	W	L	S	V1	V2	W	L	S	V1	V2	W	L	S	V1	V2
B	3528-21	4.73	4.86	17.015	27.62	10	4.61	4.46	17.215	26.52	9.5	4.51	4.08	17.375	25.81	9.24		

**Density Level A:** For low-density product applications. Recommended for wave solder applications and provides a wider process window for reflow solder processes.

**Density Level B:** For products with a moderate level of component density. Provides a robust solder attachment condition for reflow solder processes.

**Density Level C:** For high component density product applications. Before adapting the minimum land pattern variations the user should perform qualification testing based on the conditions outlined in IPC standard 7351 (IPC-7351).



## Soldering Process

### Optimum Solder Wave Profile

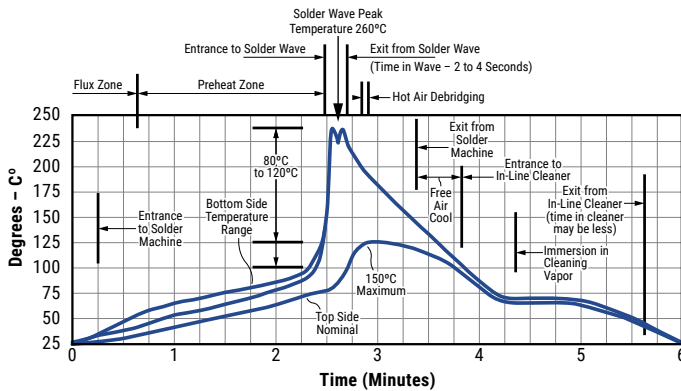

**\*T555 MUST be hand soldered only.**

### Hand Soldering (Manual)\*

#### Manual Solder Profile with Pre-heating

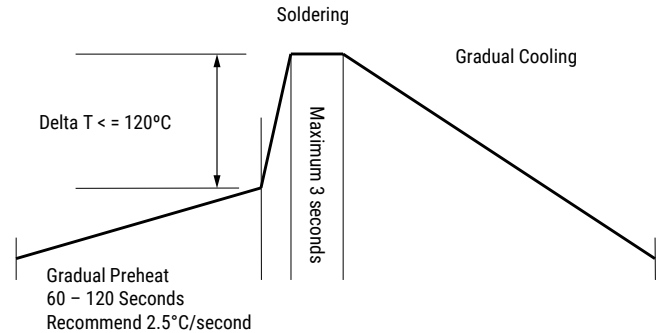

## Mounting

**WARNING: T555/T556 MUST BE HAND SOLDERED. THE USE OF STANDARD SMD PROCESSES FOR BOARD MOUNT WILL CAUSE IRREVERSIBLE DAMAGE TO THIS PRODUCT.**

### T555 SMD

In hand-soldering tantalum polymer SMT capacitors, a manufacturer can utilize two (2) soldering methodologies that include pre-heating or not pre-heating the capacitors. KEMET recommends utilizing a pre-heating technique. However, due to the large temperature gradient between the capacitors and the tip of the soldering iron, take extreme caution in this process. The thermal stresses from the large thermal gradients and the propensity of the operator touching the tip of the soldering iron to the device can lead to mechanical and/or electrical damage.

When manually soldering, it is important the soldering process be carefully monitored and carried out so that the temperature gradient falls within the recommended conditions above (profile).

## Mounting cont.

### Process 1 (with preheating)

- 1) Utilize 1.0 mm thread eutectic solder with soldering flux in the core. Either a rosin-based or non-activated flux is recommended.
- 2) The capacitors shall be pre-heated so that the temperature gradient between the devices and the tip of the soldering iron is  $\Delta T \leq 120^\circ\text{C}$  or below.
- 3) The temperature of the solder iron tip should not exceed  $270^\circ\text{C}$ .
- 4) The required amount of solder shall be melted in advance on the soldering tip.
- 5) After soldering, the capacitors shall be cooled gradually at room ambient temperature. Forced air cooling is not recommended.

### Process 2 (without preheating)

- 1) Soldering iron tip shall never directly touch the termination egress or the case body of the capacitors.
- 2) Lands are sufficiently pre-heated with a soldering iron tip before sliding the soldering iron tip to the terminal electrode of the capacitor for soldering.

Reference	Condition
Case Size	All
Temperature of soldering iron	$270^\circ\text{C}$
Wattage	20 W maximum
Shape of soldering iron	3 mm maximum
Soldering time with soldering iron	3 seconds maximum

### T550 Through-Hole

All encased capacitors will pass the resistance to soldering heat test of MIL-STD-202, Method 210, Condition C. This test simulates wave solder of topside board mount product. This demonstration of resistance to solder heat is in accordance with what is believed to be the industry standard. More severe treatment must be considered reflective of an improper soldering process. The above figure is a recommended solder wave profile for both axial and radial leaded solid tantalum capacitors.

### Additional mounting recommendations (SMD and Through-Hole):

In order to increase the board mount integrity of KEMET's Polymer Hermetic Sealed (SMD or TH version) relative to mechanical shock and vibration, KEMET recommends the use of an adhesive between the component and the PCB. This is defined in the Space Application Electronic Hardware Addendum to J-STD-001 (Requirements for Solder Electrical and Electronic Assemblies.)

## Construction



## Capacitor Marking

### T550

#### B Case

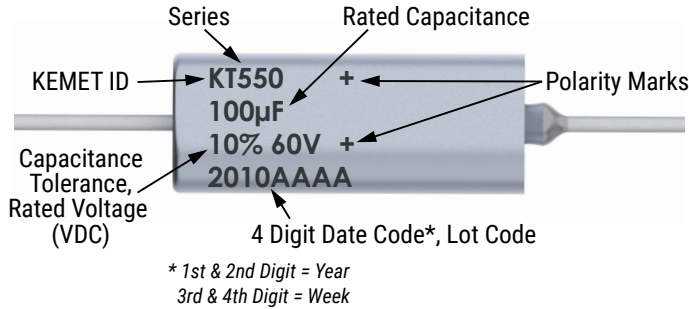

### T550 - Military Format

#### B Case

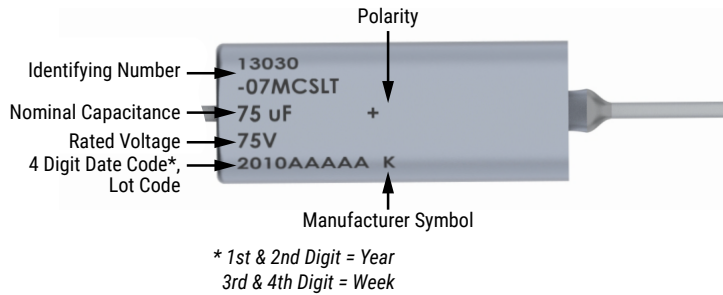

### T555

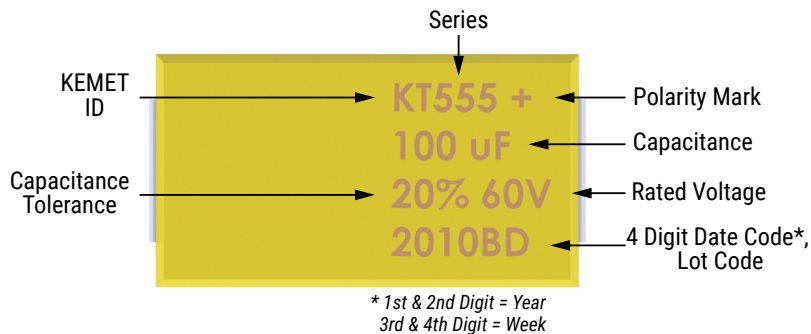

Date Code	
1st & 2nd Digit = Year	16 = 2016
	17 = 2017
	18 = 2018
	19 = 2019
	20 = 2020
3rd & 4th Digit = Week of the Year	01 = 1st week
	52 = 52nd week

## Storage

Tantalum hermetically sealed and SMD capacitors should be stored in normal working environments. While the capacitors themselves are quite robust in other environments, solderability will be degraded by exposure to high temperatures, high humidity, corrosive atmospheres, and long term storage. In addition, packaging materials will be degraded by high temperature – reels may soften or warp and tape peel force may increase. KEMET recommends that maximum storage temperature not exceed 40°C and maximum storage humidity not exceed 60% relative humidity. Temperature fluctuations should be minimized to avoid condensation on the parts and atmospheres should be free of chlorine and sulphur bearing compounds. For optimized solderability capacitors stock should be used promptly, preferably within three years of receipt.

## Packaging

Case Size		Pieces
KEMET	EIA	
B Through-hole	T2	20 per tray
B Surface mount	-	100 per box

## Weight

Case Size		Average Weight (grams)
KEMET	EIA	
B Through-hole	T2	3.63
B Surface mount	-	5.54



## KEMET Electronics Corporation Sales Offices

For a complete list of our global sales offices, please visit [www.kemet.com/sales](http://www.kemet.com/sales).

---

### Disclaimer

All product specifications, statements, information and data (collectively, the "Information") in this datasheet are subject to change. The customer is responsible for checking and verifying the extent to which the Information contained in this publication is applicable to an order at the time the order is placed. All Information given herein is believed to be accurate and reliable, but it is presented without guarantee, warranty, or responsibility of any kind, expressed or implied.

Statements of suitability for certain applications are based on KEMET Electronics Corporation's ("KEMET") knowledge of typical operating conditions for such applications, but are not intended to constitute – and KEMET specifically disclaims – any warranty concerning suitability for a specific customer application or use. The Information is intended for use only by customers who have the requisite experience and capability to determine the correct products for their application. Any technical advice inferred from this Information or otherwise provided by KEMET with reference to the use of KEMET's products is given gratis, and KEMET assumes no obligation or liability for the advice given or results obtained.

Although KEMET designs and manufactures its products to the most stringent quality and safety standards, given the current state of the art, isolated component failures may still occur. Accordingly, customer applications which require a high degree of reliability or safety should employ suitable designs or other safeguards (such as installation of protective circuitry or redundancies) in order to ensure that the failure of an electrical component does not result in a risk of personal injury or property damage.

Although all product-related warnings, cautions and notes must be observed, the customer should not assume that all safety measures are indicated or that other measures may not be required.

*KEMET is a registered trademark of KEMET Electronics Corporation.*



Компания «ЭлектроПласт» предлагает заключение долгосрочных отношений при поставках импортных электронных компонентов на взаимовыгодных условиях!

Наши преимущества:

- Оперативные поставки широкого спектра электронных компонентов отечественного и импортного производства напрямую от производителей и с крупнейших мировых складов;
- Поставка более 17-ти миллионов наименований электронных компонентов;
- Поставка сложных, дефицитных, либо снятых с производства позиций;
- Оперативные сроки поставки под заказ (от 5 рабочих дней);
- Экспресс доставка в любую точку России;
- Техническая поддержка проекта, помощь в подборе аналогов, поставка прототипов;
- Система менеджмента качества сертифицирована по Международному стандарту ISO 9001;
- Лицензия ФСБ на осуществление работ с использованием сведений, составляющих государственную тайну;
- Поставка специализированных компонентов (Xilinx, Altera, Analog Devices, Intersil, Interpoint, Microsemi, Aeroflex, Peregrine, Syfer, Eurofarad, Texas Instrument, Miteq, Cobham, E2V, MA-COM, Hittite, Mini-Circuits, General Dynamics и др.);

Помимо этого, одним из направлений компании «ЭлектроПласт» является направление «Источники питания». Мы предлагаем Вам помощь Конструкторского отдела:

- Подбор оптимального решения, техническое обоснование при выборе компонента;
- Подбор аналогов;
- Консультации по применению компонента;
- Поставка образцов и прототипов;
- Техническая поддержка проекта;
- Защита от снятия компонента с производства.



#### Как с нами связаться

**Телефон:** 8 (812) 309 58 32 (многоканальный)

**Факс:** 8 (812) 320-02-42

**Электронная почта:** [org@eplast1.ru](mailto:org@eplast1.ru)

**Адрес:** 198099, г. Санкт-Петербург, ул. Калинина, дом 2, корпус 4, литера А.