

Overview

The T550 axial leaded and T555 surface mount polymer hermetically sealed (PHS) devices are tantalum capacitors with a Ta anode and Ta₂O₅ dielectric. A conductive organic polymer replaces the traditionally used MnO₂ or wet electrolyte as the cathode plate of the capacitor. This results in very low ESR and improved capacitance retention at high frequency and low temperature. The PHS device also exhibits a benign failure mode, which eliminates the case breach that can occur in wet tantalum capacitors. Additionally, this part may be operated at voltages up to 80% of rated voltage, with equivalent or better reliability than traditional MnO₂ or wet tantalum capacitors operated at 50% of rated voltage.

PHS capacitors also offer higher ripple current handling capability and a lower ESR range than wet tantalums. With reduced ESR and enhanced capacitance retention at higher frequencies and low temperatures, these parts provide the highest total capacitance and the most economical solution for high power applications, all within an approximately 25% lighter package than the equivalent wet tantalum capacitor.

Benefits

- Includes F-Tech anode which eliminates hidden defects in the dielectric
- 100% simulated breakdown screening
- Maximum operating temperature of +105°C
- DLA drawing 13030 qualified parts available
- Polymer cathode technology
- Extremely low ESR
- High frequency and low temperature capacitance retention
- 100% constant voltage conditioning (240 hours)
- 100% surge current tested
- Volumetrically efficient
- Non-ignition failure mode
- Approximately 25% lighter than equivalent wet tantalum
- T550 case dimensions equivalent to MIL-PRF-39006/22/25/30/31
- T555 surface mount design (see dimensions diagram)

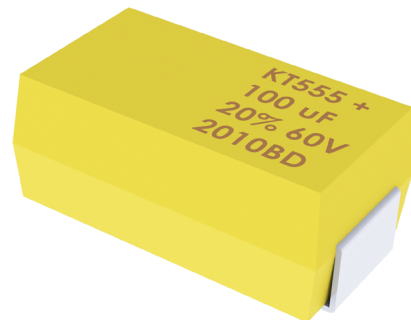

Applications

Typical applications include high voltage power management, such as buck/boost converters, filtering, hold-up capacitors, and other high ripple current applications.

Ordering Information

| T | 550 | B | 107 | M | 025 | A | T | 4251 | |
|-----------------|---|-----------|--|-----------------------|---|--|---|---|---|
| Capacitor Class | Series | Case Size | Capacitance Code (pF) | Capacitance Tolerance | Rated Voltage (VDC) | Product Level | Termination Finish | Surge Option** | Packaging** |
| T = Tantalum | 550 = Axial Leaded PHS 555 = Surface Mount PHS | B | First two digits represent significant figures. Third digit specifies number of zeros. | K = ±10% M = ±20% | 006 = 6.3 008 = 8 010 = 10 015 = 15 025 = 25 030 = 30 035 = 35 040 = 40 050 = 50 060 = 60 075 = 75 100 = 100 | A = N/A B* = DLA 13030 standard reliability T* = DLA 13030 high reliability E* = DLA 13030 "B" level equivalent for T termination F* = DLA 13030 "T" level equivalent for T termination | T = 100% tin (Sn)-plated H = Tin/lead (SnPb) solder coated (5% Pb minimum) | Blank = 25°C ±5°C, 10 cycles, after constant voltage conditioning (KEMET standard) 4251 = 10 cycles, -55°C and +85°C after constant voltage conditioning 4252 = 10 cycles, -55°C and +85°C before constant voltage conditioning | Blank = Bulk/Sleeved 0100 = Bulk/Unsleeved 7200 = Tape & Reel/Sleeved 7293 = Ammo/Sleeved 7443 = Ammo/Sleeved |

* Only available on select parts. Refer to part number table for details.

** Only for T550 (Surge options/Packaging)

Ordering Information – DLA

| 13030 | -01 | K | A | S | L | B |
|----------------|-----------------------|-----------------------|--|------------------------------|----------------------------|--|
| Drawing Number | Dash Number | Capacitance Tolerance | Surge Current Testing | Insulation | Lead Length | Product Level |
| | See Part Number Table | K = ±10% M = ±20% | A = +25°C ±5°C, 10 cycles, after constant voltage conditioning (KEMET standard) B = -55°C, -5°C, +0°C and +85°C ±5°C after constant voltage conditioning. C = -55°C, -5°C, +0°C and +85°C ±5°C before constant voltage conditioning. | S = Sleeved U = Unsleeved | L = 1.50 inches (standard) | B = Standard reliability T = High reliability |

* Standard terminations for DLA part numbers is "H" (SnPb).

Performance Characteristics

| Item | Performance Characteristics |
|-------------------------|---|
| Operating Temperature | -55°C to 105°C |
| Rated Capacitance Range | 20 – 680 µF at 120 Hz/25°C * |
| Capacitance Tolerance | K tolerance (±10%), M tolerance (±20%) |
| Rated Voltage Range | 6.3 – 100 V |
| DF (120 Hz at 25°C) | Refer to Part Number Electrical Specification Table |
| ESR (100 kHz at 25°C) | Refer to Part Number Electrical Specification Table |
| Leakage Current | Refer to Part Number Electrical Specification Table (rated voltage up to +85°C and 78% of rated voltage applied at 105°C) |
| Packaging | T550 according to MIL-PRF-39006, T555 bulk |

KEMET does not recommend storage above 85°C.

* Additional case sizes and capacitance/voltage are under development.

Qualification - T550

| Test Performed | Method Reference | Test Conditions |
|---|-------------------------------|---|
| Reliability and Environmental Tests | | |
| AC Ripple Life at 85°C | MIL-PRF-39006 | 85°C, 40 kHz ripple current, 2,000 hours |
| 85°C Life | KEMET Standard | 85°C, rated voltage, 2,000 hours |
| 105°C Life | KEMET Standard | 105°C, 0.78 x rated voltage, 2,000 hours |
| Surge Voltage | MIL-PRF-39006 | 85°C, 1.15 x rated voltage, 1,000 cycles, except delta cap shall be +10%/-20% |
| Surge Current | MIL-PRF-39003 | +25 °C, 10 cycles (Option A), Option B available |
| Low Temperature Storage | MIL-PRF-39006 | -62°C for 72 hours followed by 1 hour at 125°C |
| Reverse Voltage | KEMET Catalog | 1 V for 8 hours maximum at 25°C, 1 V for 2 hours maximum at 70°C |
| Physical, Mechanical and Process Tests | | |
| Visual and Mechanical Examination (Internal and External) | MIL-PRF-39006 | Case dimensions, marking |
| Terminal Strength | MIL-PRF-39006 | Pull test and wire lead bend test |
| Resistance to Solvents | MIL-PRF-39006 | Immersion in (3) solvents |
| Resistance to Soldering Heat | MIL-PRF-39006 | Immersed to within 0.05 inch of capacitor body |
| Solderability | MIL-PRF-39003 | Depth of insertion in flux and solder to within 0.125 inch ±0.025 inch (3.18 mm ± 0.64 mm) from end of case and from the point of "clean lead" emerging from the seal eyelet. |
| Shock and Vibration | MIL-STD-202, Methods 213, 204 | Shock Method 213, Condition I, 100 G peak, Vibration Method 204, Condition D, 20 G peak |
| Barometric Pressure (Reduced) | MIL-PRF-39006 | 150,000 feet for 5 minutes, voltage applied for 1 minute |
| Salt Atmosphere (Corrosion) | MIL-PRF-39006 | Subjected to fine mist of salt solution |
| Moisture Resistance | MIL-PRF-39006 | 65°C at 6 V |
| Dielectric Withstanding Voltage | MIL-PRF-39006 | 2,000 VDC, 60 seconds, sleeving examined for evidence of breakdown |
| Insulation Resistance | MIL-PRF-39003 | 500 VDC, 1 minute, insulation resistance not less than 1,000 MΩ |
| Electrical Characterization | | |
| Temperature Stability | Reference MIL-PRF-39006 | -55°C to 105°C |
| Frequency Scan | KEMET Standard | Impedance, ESR and capacitance versus frequency |

Qualification – DLA Approval Inspection – Only for T550

| Inspection | Test Name | DLA Requirement Paragraph | SS/Lot |
|------------|--|---------------------------|------------------|
| Group I | Shock (specified pulse) ¹ | 3.3.4 | 6 per case size |
| | Vibration, high frequency ¹ | 3.3.5 | |
| | Thermal shock | 3.3.6 | |
| | Salt atmosphere | 3.3.7 | |
| Group II | Solderability | 3.3.8 | 12 |
| | Terminal strength | 3.3.9 | |
| | Surge voltage ² | 3.3.10 | |
| | Moisture resistance | 3.3.11 | |
| | Dielectric withstanding voltage | 3.3.12 | |
| | Insulation resistance | 3.3.13 | |
| Group III | Low temperature (storage) | 3.3.14 | 13 |
| | Stability at low and high temperatures | 3.3.15 | |
| Group IV | Reverse voltage | 3.3.23 | 12 per condition |
| Group V | Life at 85°C | 3.3.16 | 102 |
| Group VI | AC ripple life at 85°C | 3.3.18 | 8 per case size |
| Group VII | Life at 105°C | 3.3.17 | 40 |
| | Barometric pressure | 3.3.20 | |
| Group VIII | Resistance to solvents | 3.3.21 | 6 |
| | Resistance to soldering heat | 3.3.22 | |

¹ No failures for mechanical shock or vibration tests shall be permitted.

² Surge voltage change in capacitance limits are wider than those in some subsequent tests.

It may be necessary to perform initial measurements again, prior to the individual tests of Group II.

Product Level:

Inspection of product for delivery shall consist of:

| | |
|---------|--|
| B level | Group A inspection specified in Drawing 13030 |
| T level | Group A and group B inspections specified in Drawing 13030 |

Qualification - T555

| Test Performed | Method Reference | Test Conditions |
|---|-------------------------------|---|
| Reliability and Environmental Tests | | |
| 105°C Life | KEMET Standard | 105°C, 0.78 x rated voltage, 2,000 hours |
| Surge Voltage | MIL-PRF-39006 | 85°C, 1.15 x rated voltage, 1,000 cycles, except delta cap shall be +10%/-20% |
| Physical, Mechanical and Process Tests | | |
| Visual and Mechanical Examination (Internal and External) | MIL-PRF-39003 | Case dimensions, marking |
| Terminal Strength | MIL-PRF-39006 | Pull test and wire lead bend test |
| Resistance to Solvents | MIL-PRF-39006 | Immersion in (3) solvents |
| Resistance to Soldering Heat | MIL-PRF-39006 | Immersed to within 0.05 inch of capacitor body |
| Solderability | MIL-PRF-39006 | Depth of insertion in flux and solder to within 0.062 inch of welded joint |
| Shock and Vibration | MIL-STD-202, Methods 213, 204 | Shock Method 213, Condition I, 100 g peak, Vibration Method 204, Condition D, 20 g peak |
| Electrical Characterization | | |
| Temperature Stability | Reference MIL-PRF-39006 | -55°C to 105°C |

Environmental Compliance

Epoxy compliant with UL 94 V-0.

Electrical Characteristics

ESR vs. Frequency



Capacitance vs. Frequency



Dimensions – Inches (Millimeters)

T550

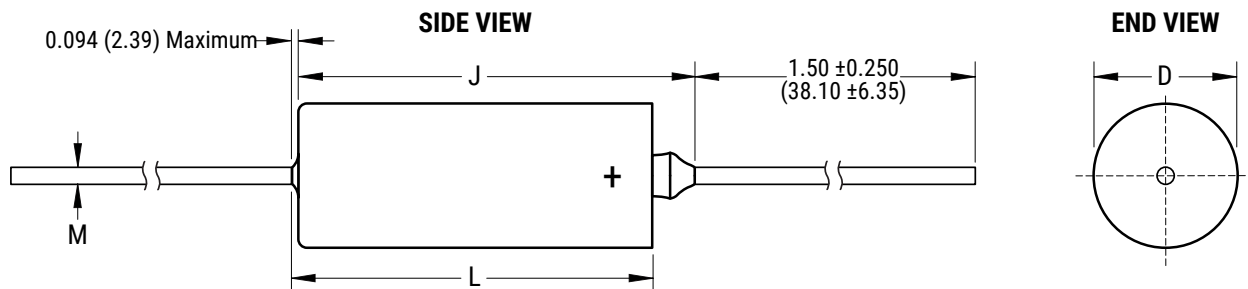

| Case Code | Case Size | Uninsulated Case | | | | Insulated Case | |
|-----------|---------------|-------------------------|---|-------------------------|---------------|---|-------------------------|
| | MIL-PRF-39006 | L ± 0.031 (0.79) | D $+0.016$ (0.41) -0.015 (0.38) | M ± 0.002 (0.05) | J maximum | D $+0.016$ (0.41) -0.015 (0.38) | L ± 0.031 (0.79) |
| B | T2 | 0.650 (16.51) | 0.279 (7.09) | 0.025 (0.64) | 0.822 (20.88) | 0.289 (7.34) | 0.686 (17.42) |

Dimensions – Millimeters

T555

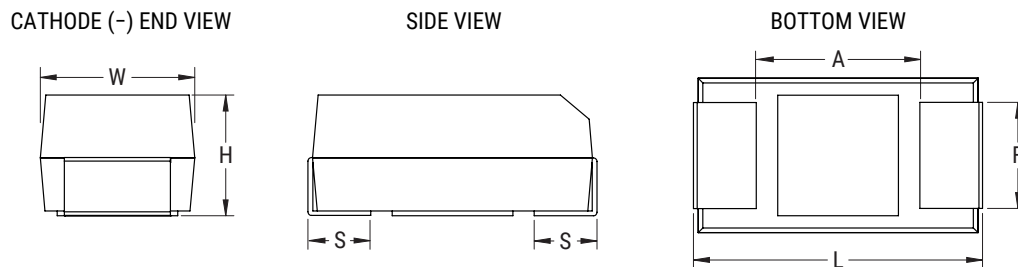

| Case Code | | | | | | Weight (g) |
|--------------------|-------------|-------------|-------------|-------------|-------------|------------|
| | L ± 0.5 | W ± 0.5 | H ± 0.5 | F ± 0.5 | S ± 0.3 | Average |
| B Surface mount | 24.5 | 8.5 | 9.1 | 4.2 | 3.0 | 5.54 |

Table 1A – Ratings & Part Number Reference

| Rated Voltage | Rated Capacitance | Case Size | KEMET Part Number | DLA Drawing Number | DC Leakage | DF | Maximum ESR | Ripple Current |
|---------------|-------------------|-----------|------------------------------|------------------------------|----------------------------------|-------------------------|-----------------------|-------------------------|
| (V) 85°C | µF | KEMET/EIA | (See below for part options) | (See below for part options) | µA at 25°C Maximum/ 5 Minutes | % at 25°C 120 Hz Max | mΩ at 25°C 100 kHz | mArms at 85°C/40 kHz |
| 6.3 | 140 | B | T550B147(1)006A(3) | N/A | 6.3 | 5.0 | 120 | 1,510 |
| 8 | 220 | B | T550B227(1)008A(3) | N/A | 13.2 | 5.0 | 120 | 1,510 |
| 8 | 680 | B | T550B687(1)008A(3) | N/A | 40.8 | 5.0 | 90 | 1750 |
| 10 | 100 | B | T550B107(1)010A(3) | N/A | 7.5 | 5.0 | 140 | 1400 |
| 10 | 180 | B | T550B187(1)010A(3) | N/A | 13.5 | 5.0 | 110 | 1580 |
| 10 | 560 | B | T550B567(1)010A(3) | N/A | 42.0 | 5.0 | 90 | 1750 |
| 15 | 70 | B | T550B706(1)015A(3) | N/A | 7.9 | 5.0 | 140 | 1400 |
| 15 | 120 | B | T550B127(1)015A(3) | N/A | 13.5 | 5.0 | 110 | 1580 |
| 15 | 390 | B | T550B397(1)015A(3) | N/A | 43.9 | 5.0 | 90 | 1750 |
| 25 | 50 | B | T550B506(1)025A(3) | N/A | 9.4 | 5.0 | 170 | 1275 |
| 25 | 100 | B | T550B107(1)025(2)(3) | 13030-01(1)(4)(5)L(6) | 18.8 | 5.0 | 190 | 1,200 |
| 25 | 100 | B | T550B107(1)025(7)T | N/A | 18.8 | 5.0 | 190 | 1,200 |
| 30 | 40 | B | T550B406(1)030A(3) | N/A | 9.0 | 5.0 | 170 | 1,275 |
| 30 | 68 | B | T550B686(1)030A(3) | N/A | 15.3 | 5.0 | 140 | 1,400 |
| 35 | 330 | B | T550B337(1)035A(3) | N/A | 86.6 | 10.0 | 180 | 1,240 |
| 40 | 100 | B | T550B107(1)040(2)(3) | 13030-02(1)(4)(5)L(6) | 30.0 | 5.0 | 150 | 1,350 |
| 40 | 100 | B | T550B107(1)040(7)T | N/A | 30.0 | 5.0 | 150 | 1,350 |
| 40 | 120 | B | T550B127(1)040(2)(3) | 13030-03(1)(4)(5)L(6) | 36.0 | 5.0 | 120 | 1,510 |
| 40 | 120 | B | T550B127(1)040(7)T | N/A | 36.0 | 5.0 | 120 | 1,510 |
| 50 | 25 | B | T550B256(1)050A(3) | N/A | 9.4 | 5.0 | 170 | 1,275 |
| 50 | 47 | B | T550B476(1)050A(3) | N/A | 17.6 | 5.0 | 150 | 1,350 |
| 50 | 100 | B | T550B107(1)050(2)(3) | 13030-04(1)(4)(5)L(6) | 37.5 | 5.0 | 130 | 1,450 |
| 50 | 100 | B | T550B107(1)050(7)T | N/A | 37.5 | 5.0 | 130 | 1,450 |
| 50 | 120 | B | T550B127(1)050(2)(3) | 13030-05(1)(4)(5)L(6) | 45.0 | 5.0 | 90 | 1,750 |
| 50 | 120 | B | T550B127(1)050(7)T | N/A | 45.0 | 5.0 | 90 | 1,750 |
| 60 | 20 | B | T550B206(1)060A(3) | N/A | 9.0 | 5.0 | 200 | 1,175 |
| 60 | 39 | B | T550B396(1)060A(3) | N/A | 17.6 | 5.0 | 160 | 1,310 |
| 60 | 100 | B | T550B107(1)060(2)(3) | 13030-06(1)(4)(5)L(6) | 45.0 | 5.0 | 100 | 1,660 |
| 60 | 100 | B | T550B107(1)060(7)T | N/A | 45.0 | 5.0 | 100 | 1,660 |
| 75 | 75 | B | T550B756(1)075(2)(3) | 13030-07(1)(4)(5)L(6) | 42.2 | 5.0 | 110 | 1,580 |
| 75 | 75 | B | T550B756(1)075(7)T | N/A | 42.2 | 5.0 | 110 | 1,580 |
| 100 | 25 | B | T550B256(1)100(2)(3) | 13030-08(1)(4)(5)L(6) | 18.8 | 5.0 | 190 | 1,200 |
| 100 | 25 | B | T550B256(1)100(7)T | N/A | 18.8 | 5.0 | 190 | 1,200 |

(1) To complete KEMET part number, insert M for ±20% or K for ±10%. Designates capacitance tolerance.

(2) To complete KEMET part number, insert A = N/A, B = standard reliability, or T = high reliability.

(3) To complete KEMET part number, insert T = 100% matte tin (Sn)-plated, H = standard solder coated (SnPb 5% Pb minimum). Designates termination finish.

(4) To complete the DLA PIN number, insert the surge current testing option, A = 25°C after voltage aging, B = -55°C +0°C and +85°C after voltage aging or C = -55°C +0°C and +85°C before voltage aging.

(5) To complete the DLA PIN number, insert the insulation option. S = Sleeved, U = Unseleaved.

(6) To complete the DLA PIN number, insert the product level option. B = standard reliability or T = high reliability.

(7) To complete KEMET part number, insert E = DLA "B" level equivalent, or F = DLA "T" level equivalent. Designates product level
Refer to Ordering Information for additional detail.

Higher voltage ratings and tighter tolerance product including ESR may be substituted within the same size at KEMET's option. Voltage substitution will be marked with the higher voltage rating. The 85°C 40 kHz ripple limit is based on the maximum allowed power at 85°C and the maximum expected ESR at 40 kHz. For this calculation, the 100 kHz ESR limit is multiplied by a factor of 1.3 to account for the frequency dependence of ESR.

Table 1B – Ratings & Part Number Reference

| Rated Voltage | Rated Capacitance | Case Size | KEMET Part Number | DC Leakage | DF | Maximum ESR | Ripple Current |
|---------------|-------------------|-----------|------------------------------|----------------------------------|-------------------------|-----------------------|-------------------------|
| (V) 85°C | µF | KEMET/EIA | (See below for part options) | µA at 25°C Maximum/ 5 Minutes | % at 25°C 120 Hz Max | mΩ at 25°C 100 kHz | mArms at 85°C/40 kHz |
| 6.3 | 140 | B | T555B147(1)006A(3) | 6.3 | 5.0 | 120 | 1,510 |
| 8 | 220 | B | T555B227(1)008A(3) | 13.2 | 5.0 | 120 | 1,510 |
| 8 | 680 | B | T555B687(1)008A(3) | 40.8 | 5.0 | 90 | 1,750 |
| 10 | 100 | B | T555B107(1)010A(3) | 7.5 | 5.0 | 140 | 1,400 |
| 10 | 180 | B | T555B187(1)010A(3) | 13.5 | 5.0 | 110 | 1,580 |
| 10 | 560 | B | T555B567(1)010A(3) | 42.0 | 5.0 | 90 | 1,750 |
| 15 | 70 | B | T555B706(1)015A(3) | 7.9 | 5.0 | 140 | 1,400 |
| 15 | 120 | B | T555B127(1)015A(3) | 13.5 | 5.0 | 110 | 1,580 |
| 15 | 390 | B | T555B397(1)015A(3) | 43.9 | 5.0 | 90 | 1,750 |
| 25 | 50 | B | T555B506(1)025A(3) | 9.4 | 5.0 | 170 | 1,275 |
| 25 | 100 | B | T555B107(1)025A(3) | 18.8 | 5.0 | 190 | 1,200 |
| 30 | 40 | B | T555B406(1)030A(3) | 9.0 | 5.0 | 170 | 1,275 |
| 30 | 68 | B | T555B686(1)030A(3) | 15.3 | 5.0 | 140 | 1,400 |
| 35 | 330 | B | T555B337(1)035A(3) | 86.6 | 10.0 | 180 | 1,240 |
| 40 | 100 | B | T555B107(1)040A(3) | 30.0 | 5.0 | 150 | 1,350 |
| 40 | 120 | B | T555B127(1)040A(3) | 36.0 | 5.0 | 120 | 1,510 |
| 50 | 25 | B | T555B256(1)050A(3) | 9.4 | 5.0 | 170 | 1,275 |
| 50 | 47 | B | T555B476(1)050A(3) | 17.6 | 5.0 | 150 | 1,350 |
| 50 | 100 | B | T555B107(1)050A(3) | 37.5 | 5.0 | 130 | 1,450 |
| 50 | 120 | B | T555B127(1)050A(3) | 45.0 | 5.0 | 90 | 1,750 |
| 60 | 20 | B | T555B206(1)060A(3) | 9.0 | 5.0 | 200 | 1,175 |
| 60 | 39 | B | T555B396(1)060A(3) | 17.6 | 5.0 | 160 | 1,310 |
| 60 | 100 | B | T555B107(1)060A(3) | 45.0 | 5.0 | 100 | 1,660 |
| 75 | 75 | B | T555B756(1)075A(3) | 42.2 | 5.0 | 110 | 1,580 |
| 100 | 25 | B | T555B256(1)100A(3) | 18.8 | 5.0 | 190 | 1,200 |

(1) To complete KEMET part number, insert M for ±20% or K for ±10%. Designates capacitance tolerance.

(3) To complete KEMET part number, insert T = 100% Matte Tin (Sn)-plated, H = Standard Solder coated (SnPb 5% Pb minimum). Designates termination finish.

Refer to Ordering Information for additional detail.

Higher voltage ratings and tighter tolerance product including ESR may be substituted within the same size at KEMET's option. Voltage substitution will be marked with the higher voltage rating. The 85°C 40 kHz ripple limit is based on the maximum allowed power at 85°C and the maximum expected ESR at 40 kHz. For this calculation, the 100 kHz ESR limit is multiplied by a factor of 1.3 to account for the frequency dependence of ESR.

Recommended Voltage Derating Guidelines

| | -55°C to 85°C | 85°C to 105°C |
|---|---------------|---------------|
| % Change in working DC voltage with temperature | V_R | 78% of V_R |
| Recommended maximum application voltage (as % of rated voltage) | 80% of V_R | 63% of V_R |

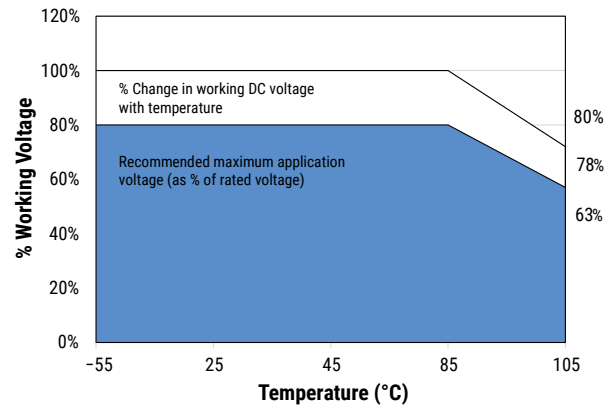

Ripple Current/Ripple Voltage

Permissible AC ripple voltage and current are related to equivalent series resistance (ESR) and the power dissipation capabilities of the device. Permissible AC ripple voltage that may be applied is limited by two criteria:

1. The positive peak AC voltage plus the DC bias voltage, if any, must not exceed the DC voltage rating of the capacitor.
2. The negative peak AC voltage in combination with bias voltage, if any, must not exceed the allowable limits specified for reverse voltage.

The maximum power dissipation by case size can be determined using the below left table. The maximum power dissipation rating stated in the table must be reduced with increasing environmental operating temperatures. Refer to the below right table for temperature compensation requirements.

| Case Code | | Maximum Power Dissipation (P_{max}) mWatts at 25°C with +60°C Rise |
|-----------|---|--|
| KEMET | MIL-PRF-39006/22/ 25/30/31 Case size | |
| B* | T2 | 715 |

* Applies to TH and SMD

| Temperature Compensation Multipliers for Maximum Power Dissipation (P_{max}) | | |
|---|--|---|
| $T \leq 45^\circ\text{C}$ | $45^\circ\text{C} < T \leq 85^\circ\text{C}$ | $85^\circ\text{C} < T \leq 105^\circ\text{C}$ |
| 1.00 | 0.70 | 0.10 |

T = Environmental temperature

Using the P_{max} of the device, the maximum allowable rms ripple current or voltage may be determined.

$$I(max) = \sqrt{P_{max}/R}$$

$$E(max) = Z \sqrt{P_{max}/R}$$

I = rms ripple current (amperes)

E = rms ripple voltage (volts)

P_{max} = maximum power dissipation (watts)

R = ESR at specified frequency (ohms)

Z = Impedance at specified frequency (ohms)

The maximum power dissipation rating must be reduced with increasing environmental operating temperatures. Refer to the Temperature Compensation Multiplier table for details.

Reverse Voltage

Solid tantalum polymer capacitors are polar devices and may be permanently damaged or destroyed if connected with the wrong polarity. A small reverse voltage is permissible for time periods per the below table. KEMET can offer lower capacitance in this voltage with higher reverse voltage capability. In addition, we continue to improve our capability for this characteristic.

| Temperature | Permissible Reverse Voltage |
|-------------|-----------------------------|
| 25°C | 1 V for 8 hours maximum |
| 70°C | 1 V for 2 hours maximum |

Table 2 – Land Dimensions/Courtyard

| KEMET | Metric Size Code | Density Level A: Maximum (Most) Land Protrusion (mm) | | | | | Density Level B: Median (Nominal) Land Protrusion (mm) | | | | | Density Level C: Minimum (Least) Land Protrusion (mm) | | | | | | |
|-------|------------------|---|------|--------|-------|----|---|------|--------|-------|-----|--|------|--------|-------|------|----|----|
| | | Case | EIA | W | L | S | V1 | V2 | W | L | S | V1 | V2 | W | L | S | V1 | V2 |
| B | 3528-21 | 4.73 | 4.86 | 17.015 | 27.62 | 10 | 4.61 | 4.46 | 17.215 | 26.52 | 9.5 | 4.51 | 4.08 | 17.375 | 25.81 | 9.24 | | |

Density Level A: For low-density product applications. Recommended for wave solder applications and provides a wider process window for reflow solder processes.

Density Level B: For products with a moderate level of component density. Provides a robust solder attachment condition for reflow solder processes.

Density Level C: For high component density product applications. Before adapting the minimum land pattern variations the user should perform qualification testing based on the conditions outlined in IPC standard 7351 (IPC-7351).



Soldering Process

Optimum Solder Wave Profile

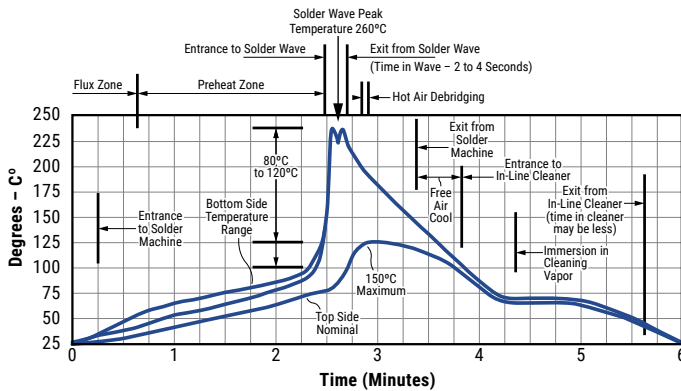

***T555 MUST be hand soldered only.**

Hand Soldering (Manual)*

Manual Solder Profile with Pre-heating

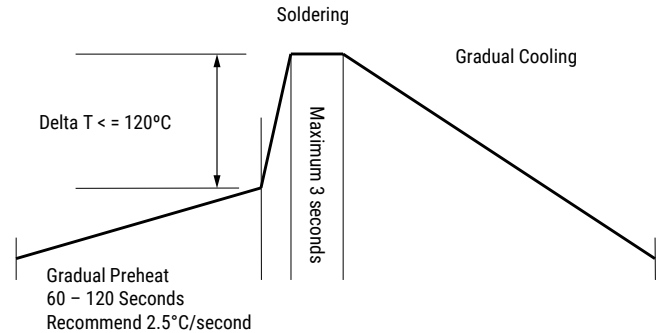

Mounting

WARNING: T555/T556 MUST BE HAND SOLDERED. THE USE OF STANDARD SMD PROCESSES FOR BOARD MOUNT WILL CAUSE IRREVERSIBLE DAMAGE TO THIS PRODUCT.

T555 SMD

In hand-soldering tantalum polymer SMT capacitors, a manufacturer can utilize two (2) soldering methodologies that include pre-heating or not pre-heating the capacitors. KEMET recommends utilizing a pre-heating technique. However, due to the large temperature gradient between the capacitors and the tip of the soldering iron, take extreme caution in this process. The thermal stresses from the large thermal gradients and the propensity of the operator touching the tip of the soldering iron to the device can lead to mechanical and/or electrical damage.

When manually soldering, it is important the soldering process be carefully monitored and carried out so that the temperature gradient falls within the recommended conditions above (profile).

Mounting cont.

Process 1 (with preheating)

- 1) Utilize 1.0 mm thread eutectic solder with soldering flux in the core. Either a rosin-based or non-activated flux is recommended.
- 2) The capacitors shall be pre-heated so that the temperature gradient between the devices and the tip of the soldering iron is $\Delta T \leq 120^\circ\text{C}$ or below.
- 3) The temperature of the solder iron tip should not exceed 270°C .
- 4) The required amount of solder shall be melted in advance on the soldering tip.
- 5) After soldering, the capacitors shall be cooled gradually at room ambient temperature. Forced air cooling is not recommended.

Process 2 (without preheating)

- 1) Soldering iron tip shall never directly touch the termination egress or the case body of the capacitors.
- 2) Lands are sufficiently pre-heated with a soldering iron tip before sliding the soldering iron tip to the terminal electrode of the capacitor for soldering.

| Reference | Condition |
|------------------------------------|---------------------|
| Case Size | All |
| Temperature of soldering iron | 270°C |
| Wattage | 20 W maximum |
| Shape of soldering iron | 3 mm maximum |
| Soldering time with soldering iron | 3 seconds maximum |

T550 Through-Hole

All encased capacitors will pass the resistance to soldering heat test of MIL-STD-202, Method 210, Condition C. This test simulates wave solder of topside board mount product. This demonstration of resistance to solder heat is in accordance with what is believed to be the industry standard. More severe treatment must be considered reflective of an improper soldering process. The above figure is a recommended solder wave profile for both axial and radial leaded solid tantalum capacitors.

Additional mounting recommendations (SMD and Through-Hole):

In order to increase the board mount integrity of KEMET's Polymer Hermetic Sealed (SMD or TH version) relative to mechanical shock and vibration, KEMET recommends the use of an adhesive between the component and the PCB. This is defined in the Space Application Electronic Hardware Addendum to J-STD-001 (Requirements for Solder Electrical and Electronic Assemblies.)

Construction



Capacitor Marking

T550

B Case

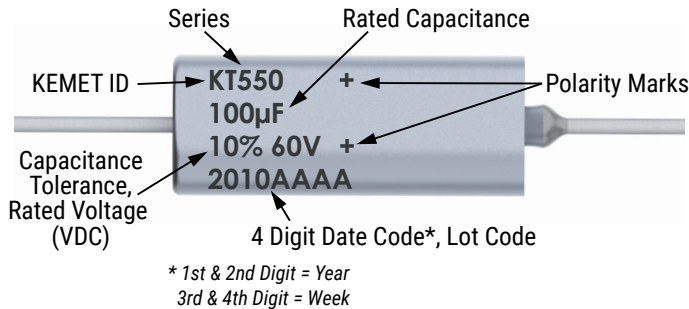

T550 - Military Format

B Case

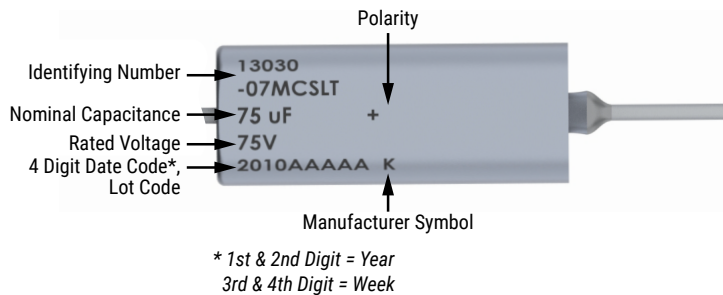

T555

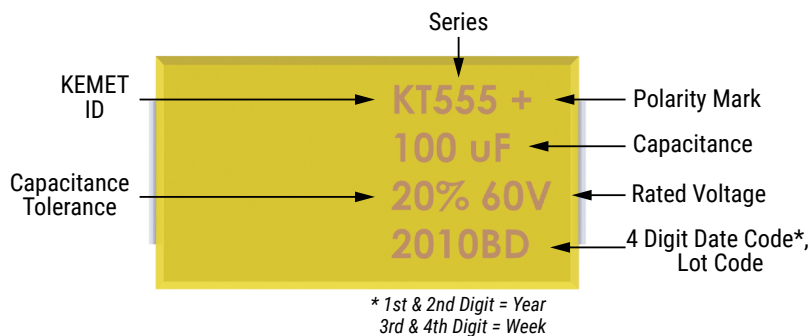

| Date Code | |
|------------------------------------|----------------|
| 1st & 2nd Digit = Year | 16 = 2016 |
| | 17 = 2017 |
| | 18 = 2018 |
| | 19 = 2019 |
| | 20 = 2020 |
| 3rd & 4th Digit = Week of the Year | 01 = 1st week |
| | 52 = 52nd week |

Storage

Tantalum hermetically sealed and SMD capacitors should be stored in normal working environments. While the capacitors themselves are quite robust in other environments, solderability will be degraded by exposure to high temperatures, high humidity, corrosive atmospheres, and long term storage. In addition, packaging materials will be degraded by high temperature – reels may soften or warp and tape peel force may increase. KEMET recommends that maximum storage temperature not exceed 40°C and maximum storage humidity not exceed 60% relative humidity. Temperature fluctuations should be minimized to avoid condensation on the parts and atmospheres should be free of chlorine and sulphur bearing compounds. For optimized solderability capacitors stock should be used promptly, preferably within three years of receipt.

Packaging

| Case Size | | Pieces |
|-----------------|-----|-------------|
| KEMET | EIA | |
| B Through-hole | T2 | 20 per tray |
| B Surface mount | - | 100 per box |

Weight

| Case Size | | Average Weight (grams) |
|-----------------|-----|---------------------------|
| KEMET | EIA | |
| B Through-hole | T2 | 3.63 |
| B Surface mount | - | 5.54 |

KEMET Electronics Corporation Sales Offices

For a complete list of our global sales offices, please visit www.kemet.com/sales.

Disclaimer

All product specifications, statements, information and data (collectively, the "Information") in this datasheet are subject to change. The customer is responsible for checking and verifying the extent to which the Information contained in this publication is applicable to an order at the time the order is placed. All Information given herein is believed to be accurate and reliable, but it is presented without guarantee, warranty, or responsibility of any kind, expressed or implied.

Statements of suitability for certain applications are based on KEMET Electronics Corporation's ("KEMET") knowledge of typical operating conditions for such applications, but are not intended to constitute – and KEMET specifically disclaims – any warranty concerning suitability for a specific customer application or use. The Information is intended for use only by customers who have the requisite experience and capability to determine the correct products for their application. Any technical advice inferred from this Information or otherwise provided by KEMET with reference to the use of KEMET's products is given gratis, and KEMET assumes no obligation or liability for the advice given or results obtained.

Although KEMET designs and manufactures its products to the most stringent quality and safety standards, given the current state of the art, isolated component failures may still occur. Accordingly, customer applications which require a high degree of reliability or safety should employ suitable designs or other safeguards (such as installation of protective circuitry or redundancies) in order to ensure that the failure of an electrical component does not result in a risk of personal injury or property damage.

Although all product-related warnings, cautions and notes must be observed, the customer should not assume that all safety measures are indicated or that other measures may not be required.

KEMET is a registered trademark of KEMET Electronics Corporation.



Компания «ЭлектроПласт» предлагает заключение долгосрочных отношений при поставках импортных электронных компонентов на взаимовыгодных условиях!

Наши преимущества:

- Оперативные поставки широкого спектра электронных компонентов отечественного и импортного производства напрямую от производителей и с крупнейших мировых складов;
- Поставка более 17-ти миллионов наименований электронных компонентов;
- Поставка сложных, дефицитных, либо снятых с производства позиций;
- Оперативные сроки поставки под заказ (от 5 рабочих дней);
- Экспресс доставка в любую точку России;
- Техническая поддержка проекта, помощь в подборе аналогов, поставка прототипов;
- Система менеджмента качества сертифицирована по Международному стандарту ISO 9001;
- Лицензия ФСБ на осуществление работ с использованием сведений, составляющих государственную тайну;
- Поставка специализированных компонентов (Xilinx, Altera, Analog Devices, Intersil, Interpoint, Microsemi, Aeroflex, Peregrine, Syfer, Eurofarad, Texas Instrument, Miteq, Cobham, E2V, MA-COM, Hittite, Mini-Circuits, General Dynamics и др.);

Помимо этого, одним из направлений компании «ЭлектроПласт» является направление «Источники питания». Мы предлагаем Вам помощь Конструкторского отдела:

- Подбор оптимального решения, техническое обоснование при выборе компонента;
- Подбор аналогов;
- Консультации по применению компонента;
- Поставка образцов и прототипов;
- Техническая поддержка проекта;
- Защита от снятия компонента с производства.



Как с нами связаться

Телефон: 8 (812) 309 58 32 (многоканальный)

Факс: 8 (812) 320-02-42

Электронная почта: org@eplast1.ru

Адрес: 198099, г. Санкт-Петербург, ул. Калинина, дом 2, корпус 4, литера А.