

Compact Video Driver Series for DSCs and Portable Devices



Ultra-compact Waferlevel Chip Size Package Output Capacitor-less Single Output Video Drivers

BH76906GU, BH76909GU, BH76912GU, BH76916GU, BH76706GU

No. 09064EAT01

●Description

Due to a built-in charge pump circuit, this video driver does not require the large capacity tantalum capacitor at the video output pin that is essential in conventional video drivers. Features such as a built-in LPF that has bands suited to mobile equipment, current consumption of 0 μ A at standby, and low voltage operation from as low as 2.5 V make it optimal for digital still cameras, mobile phones, and other equipment in which high density mounting is demanded.

●Features

- 1) WLCSP ultra-compact package (1.6 mm x 1.6 mm x 0.75 mm)
- 2) Improved noise characteristics over BH768xxFVM series
- 3) Four video driver amplifier gains in lineup: 6 dB, 9 dB, 12 dB, 16.5 dB
- 4) Large output video driver of maximum output voltage 5.2 Vpp. Ample operation margin for supporting even low voltage operation
- 5) Output coupling capacitor not needed, contributing to compact design
- 6) Built-in standby function and circuit current of 0 μ A (typ) at standby
- 7) Clear image playback made possible by built-in 8th-order 4.5 MHz LPF
- 8) Due to use of bias input format, supports not only video signals but also chroma signals and RGB signals
- 9) Due to built-in output pin shunt switch, video output pin can be used as video input pin (BH76706GU)

●Applications

Mobile phone, digital still camera, digital video camera, hand-held game, portable media player

●Line up matrix

Product Name	Video Driver Amplifier Gain	Recommended Input Level	Video Output Pin Shunt Function
BH76906GU	6dB	1Vpp	—
BH76909GU	9dB	0.7Vpp	
BH76912GU	12dB	0.5Vpp	
BH76916GU	16.5dB	0.3Vpp	
BH76706GU	6dB	1Vpp	○

●Absolute Maximum Ratings (Ta = 25 °C)

Parameter	Symbol	Rating	Unit
Supply voltage	V _{cc}	3.55	V
Power dissipation	P _d	580	mW
Operating temperature range	T _{opr}	-40~+85	°C
Storage temperature range	T _{stg}	-55~+125	°C

* When mounted on a 50 mmx58 mmx1.6 mm glass epoxy board, reduce by 5.8mW/°C above Ta=+25°C.

●Operating Range

Parameter	Symbol	Min.	Typ.	Max.	Unit
Supply voltage	V _{CC}	2.5	3.0	3.45	V

●Electrical Characteristics

[Unless otherwise specified, Typ. : Ta = 25 °C, VCC = 3V]

Parameter	Symbol	Typical Values					Unit	Measurement Conditions	
		BH76906 GU	BH76909 GU	BH76912 GU	BH76916 GU	BH76706 GU			
Circuit current 1-1	I _{CC1-1}	15.0					mA	In active mode (No signal)	
Circuit current 1-2	I _{CC1-2}	17.0					mA	In active mode (Outputting NTSC color bar signal)	
Circuit current 2	I _{CC2}	0.0					μA	In standby mode	
Circuit current 3	I _{CC3}	—					100	μA	In input mode (Applying B3 = 1.5 V)
Standby switch input current High Level	I _{thH1}	45					—	μA	Applying B3 = 3.0 V
Standby switch switching voltage High Level	V _{thH1}	1.2V _{min}						V	Active mode
Standby switch switching voltage Low Level	V _{thL1}	0.45V _{max}						V	Standby mode
Standby switch outflow current High Level	I _{thH2}	—					0	μA	Applying B3 = 3.0 V
Standby switch outflow current Middle Level	I _{thM2}						8	μA	Applying B3 = 1.5 V
Standby switch outflow current Low Level	I _{thL2}						23	μA	Applying B3 = 0 V
Mode switching voltage High Level	V _{thH2}						VCC -0.2 (MIN.)	V	Standby mode
Mode switching voltage Middle Level	V _{thM2}	VCC/2 (TYP.)	V	Input mode					
Mode switching voltage low Level	V _{thL2}	0.2 (MAX.)	V	Active mode					
Voltage gain	G _V	6.0	9.0	12.0	16.5	6.0	dB	V _o =100kHz, 1.0V _{pp}	
Maximum output level	V _{omv}	5.2					V _{pp}	f=10kHz, THD=1%	
Frequency characteristic 1	G _{f1}	-0.2					-0.2	dB	f=4.5MHz/100kHz
Frequency characteristic 2	G _{f2}	-1.5					-1.4	dB	f=8.0MHz/100kHz
Frequency characteristic 3	G _{f3}	-26					-28	dB	f=18MHz/100kHz
Frequency characteristic 4	G _{f4}	-44					-48	dB	f=23.5MHz/100kHz
Differential gain	D _G	0.5					%	V _o =1.0V _{p-p} Inputting standard staircase Signal	
Differential phase	D _P	1.0					deg	V _o =1.0V _{p-p} Inputting standard staircase signal	
Y signal to noise ratio	SN _Y	+74	+73	+70	+70	+74	dB	100 kHz~6MHz band Inputting 100% white video signal	
C AM signal to noise ratio	SN _{CA}	+77	+76	+75	+75	+77	dB	100~500 kHz band Inputting 100% chroma video signal	
C PM signal to noise ratio	SN _{CP}	+65					dB	100~500 kHz band Inputting 100% chroma video signal	
Current able to flow into output pin	I _{extin}	30					mA	Applying 4.5 V to output pin through 150 Ω	
Output DC offset	V _{off}	±50 _{max}					mV	With no signal V _{off} = (V _{out pin voltage}) ÷ 2	
Input impedance	R _{in}	150					kΩ	Measure inflowing current when applying A3 = 1 V	
Output pin shunt switch on resistance	R _{on}	—					3	Ω	

● Test Circuit Diagram

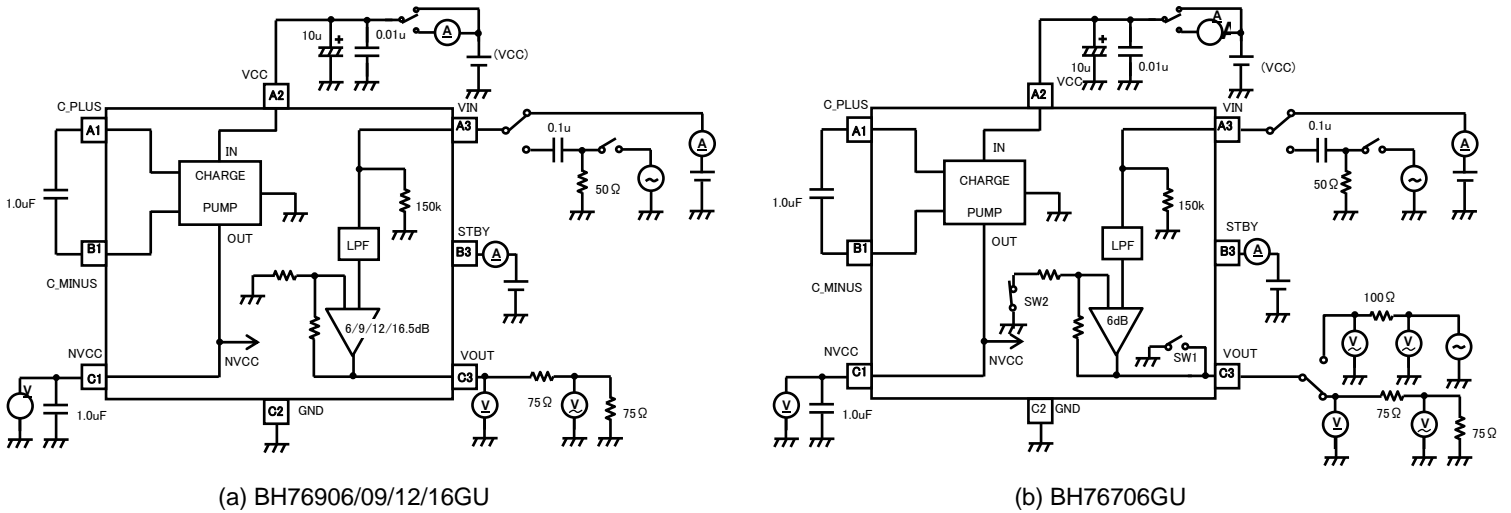

Fig. 1

※ A test circuit is a circuit for shipment inspection and differs from an application circuit example.

● Block Diagram

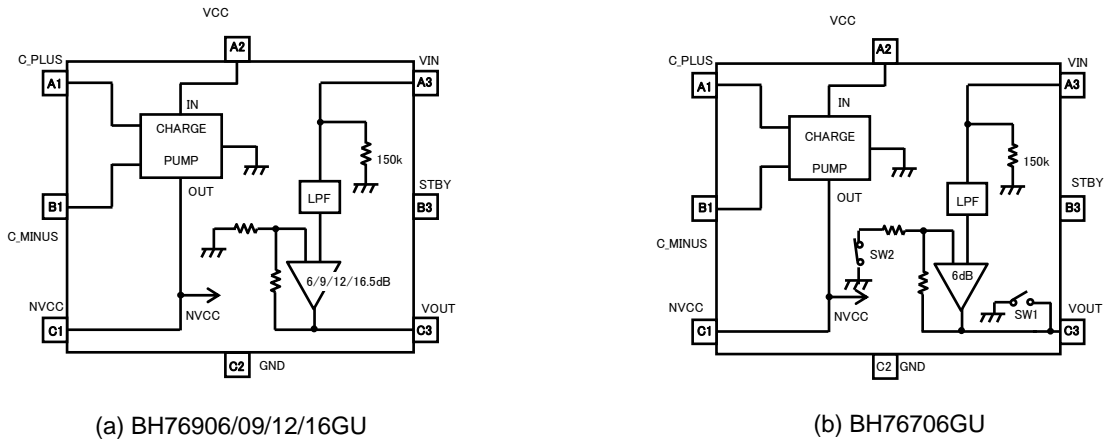

Fig. 2

● Operation Logic

BH769xxGU

STBY Pin Logic	Operating Mode
H	Active
L	Standby
OPEN	

BH76706GU

STBY Pin Logic	Operating Mode	SW1	SW2
H	Standby	OFF	OFF
M	Input (Record)	ON	OFF
L	Active (Playback)	OFF	ON

※Use of the BH76706GU with the STBY pin OPEN is inappropriate

● Pin Descriptions

Ball	Pin Name	Pin Internal Equivalent Circuit Diagram	DC Voltage	Functional Description						
A1	C_PLUS		+VCC ↑ ↓ 0V	Flying capacitor "+" pin See functional descriptions of 7pin, 8pin						
A2	VCC		VCC	VCC pin						
A3	VIN		0V	Video signal input pin Suitable input signals include composite video signals, chroma signals, R.G.B. signals						
B3	STBY	BH769xxGU 	VCC to 0V	ACTIVE/STANBY switching pin <table border="1"> <thead> <tr> <th>Pin Voltage</th> <th>MODE</th> </tr> </thead> <tbody> <tr> <td>1.2 V ~ VCC (H)</td> <td>ACTIVE</td> </tr> <tr> <td>0 V ~ 0.45 V (L)</td> <td>STANBY</td> </tr> </tbody> </table>	Pin Voltage	MODE	1.2 V ~ VCC (H)	ACTIVE	0 V ~ 0.45 V (L)	STANBY
		Pin Voltage		MODE						
1.2 V ~ VCC (H)	ACTIVE									
0 V ~ 0.45 V (L)	STANBY									
BH76706GU 	MODE switching pin <table border="1"> <thead> <tr> <th>Pin Voltage</th> <th>MODE</th> </tr> </thead> <tbody> <tr> <td>2.8 V ~ VCC (H)</td> <td>STANBY</td> </tr> <tr> <td>1.3 V ~ 1.7 V (M)</td> <td>GND (Record)</td> </tr> <tr> <td>0 V ~ 0.2 V (L)</td> <td>ACTIVE (Playback)</td> </tr> </tbody> </table>	Pin Voltage	MODE	2.8 V ~ VCC (H)	STANBY	1.3 V ~ 1.7 V (M)	GND (Record)	0 V ~ 0.2 V (L)	ACTIVE (Playback)	
Pin Voltage	MODE									
2.8 V ~ VCC (H)	STANBY									
1.3 V ~ 1.7 V (M)	GND (Record)									
0 V ~ 0.2 V (L)	ACTIVE (Playback)									
C3	VOUT		0V	Video signal output pin 						
C2	GND		0V	GND pin						

Note 1) DC voltages in the figure are those when VCC = 3.0 V. Moreover, these values are reference values which are not guaranteed.

Note 2) Numeric values in the figure are settings which do not guarantee ratings.

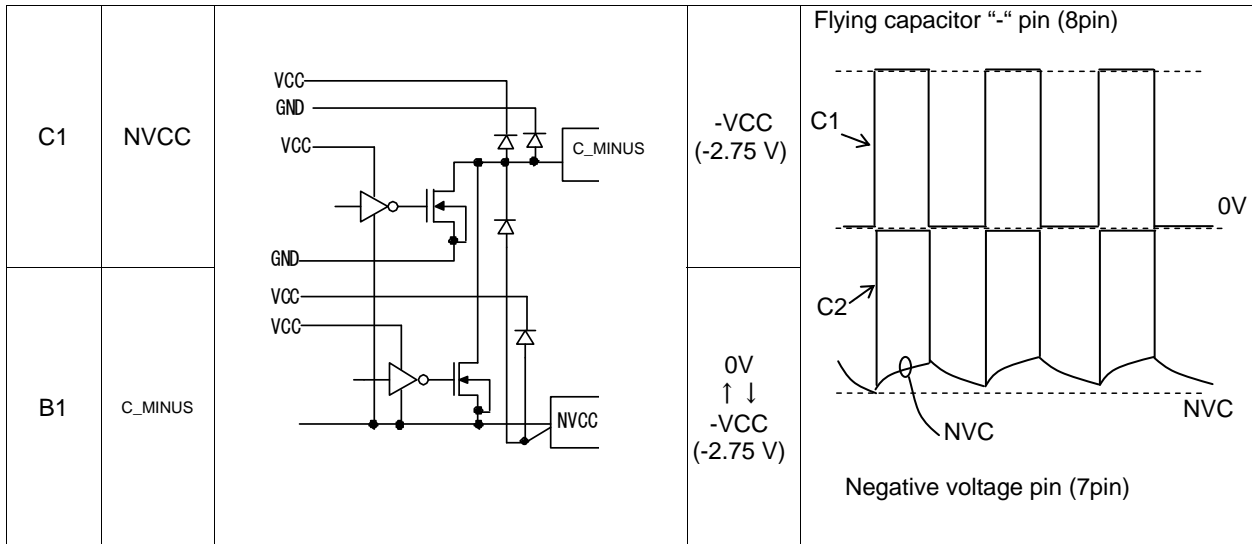

Note 1) DC voltages in the figure are those when VCC = 3.0 V. Moreover, these values are reference values which are not guaranteed.
 Note 2) Numeric values in the figure are settings which do not guarantee ratings.

●Description of Operation

1) Principles of output coupling capacitorless video drivers

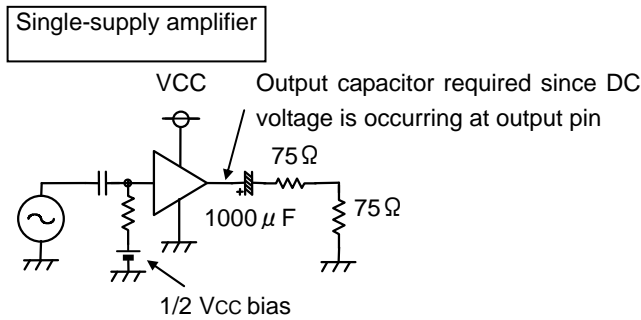

Fig.3

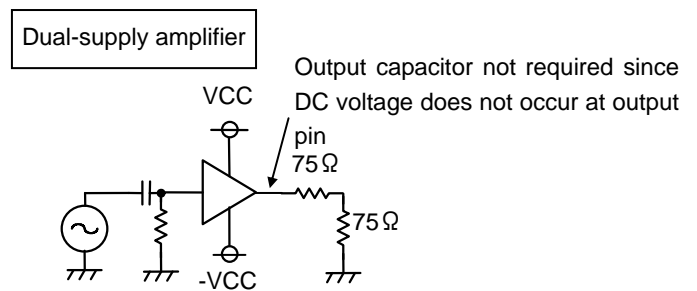

Fig.4

For an amplifier operated from a single power supply (single-supply), since the operating point has a potential of approximately 1/2 Vcc, a coupling capacitor is required for preventing direct current in the output. Moreover, since the load resistance is 150 Ω (75 Ω + 75 Ω) for the video driver, the capacity of the coupling capacitor must be on the order of 1000 μF if you take into account the low band passband. (Fig.3)

For an amplifier operated from dual power supplies (± supply), since the operating point can be at GND level, a coupling capacitor for preventing output of direct current is not needed. Moreover, since a coupling capacitor is not needed, in principle, there is no lowering of the low band characteristic at the output stage. (Fig.4)

2) Occurrence of negative voltage due to charge pump circuit

A charge pump, as shown in Fig. 5, consists of a pair of switches (SW1, SW2) and a pair of capacitors (flying capacitor, anchor capacitor). Switching the pair of switches as shown in Fig. 5 causes a negative voltage to occur by shifting the charge in the flying capacitor to the anchor capacitor as in a bucket relay.

In this IC, by applying a voltage of +3 V, a negative voltage of approximately -2.8 V is obtained.

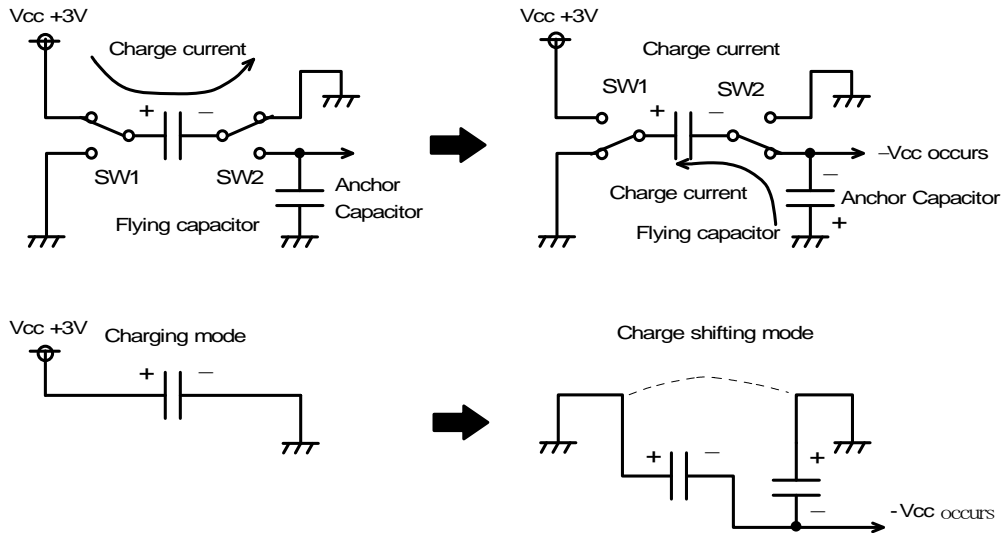

Fig.5 Principles of Charge Pump Circuit

3) Configuration of BH769xxGU and BH76706GU

As shown in Fig. 6, a BH769xxGU or BH76706GU is a dual-supply amplifier and charge pump circuit integrated in one IC. Accordingly, while there is +3 V single-supply operation, since a dual-supply operation amplifier is used, an output coupling capacitor is not needed.

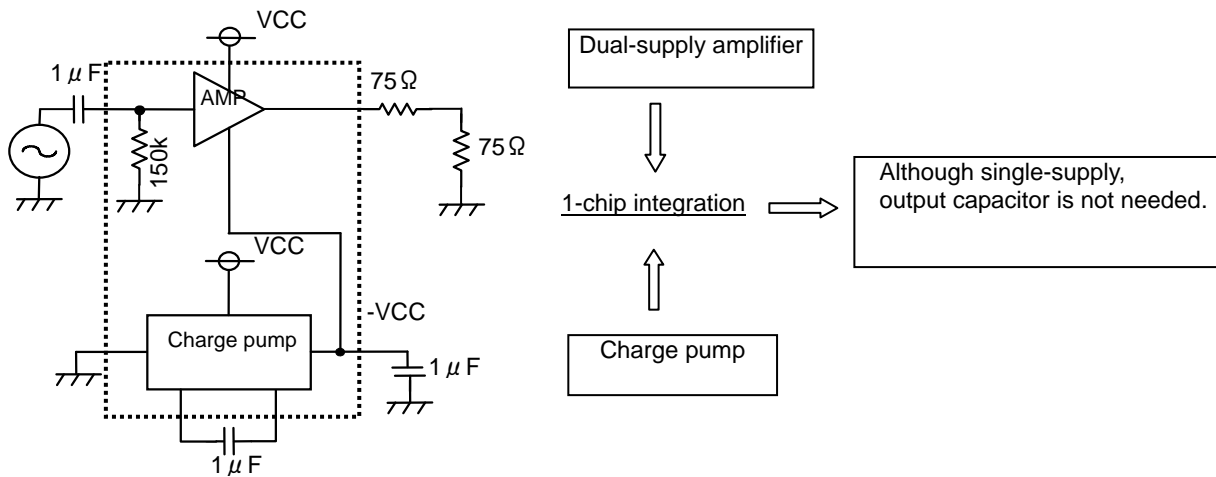

Fig.6 Configuration Diagram of BH769xxGU or BH76706GU

4) Input pin format and sag characteristic

While a BH769xxGU or BH76706GU is a low voltage operation video driver, since it has a large dynamic range of approximately 5.2 Vpp, a resistance termination method that is compatible regardless of signal form (termination by 150 kΩ) is used, and not a clamp method that is an input method exclusively for video signals.

Therefore, since a BH769xxGU or BH76706GU operates normally even if there is no synchronization signal in the input signal, it is compatible with not only normal video signals but also chroma signals and R.G.B. signals and has a wide application range.

Moreover, concerning sag (lowering of low band frequency) that occurs at the input pin and becomes a problem for the resistance termination method, since the input termination resistor is a high 150 kΩ, even if it is combined with a small capacity input capacitor, a sag characteristic that is not a problem in actual use is obtained.

In evaluating the sag characteristic, it is recommended that you use an H-bar signal in which sag readily stands out. (Fig. 8 to Fig. 10)

Input capacitor and input impedance cutoff frequency is the same as when output capacitor in generic 75 Ω driver is made 1000 μF.
 $1 \mu\text{F} \times 150 \text{ k}\Omega = 1000 \mu\text{F} \times 150 \Omega$
 (Input pin time constant) (Output pin time constant)

Sag is determined by input capacitor and input resistor only.

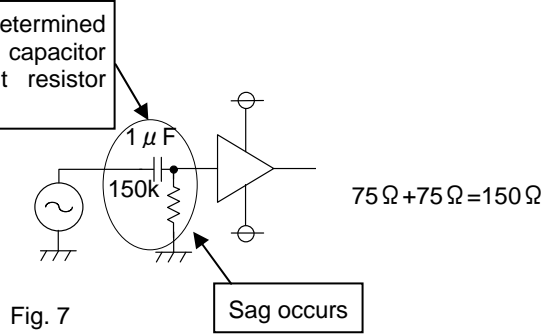
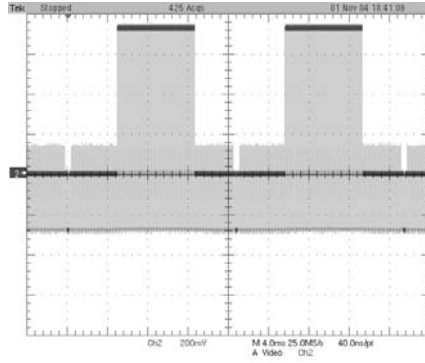

Fig. 7

a) Video signal without sag (TG-7/1 output, H-bar)



TV screen output image of H-bar signal

Fig. 8

b) BH769xxGU or BH76706GU output (Input = 1.0 μF, TG-7/1 output, H-bar)

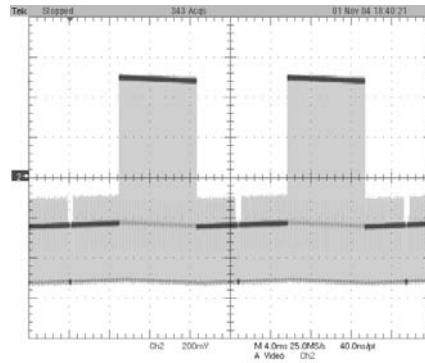
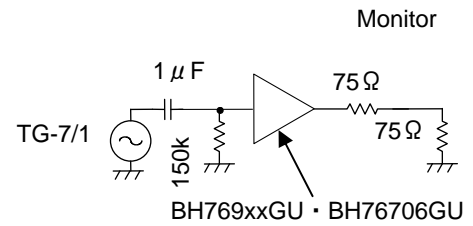

Fig. 9



Nearly identical sag

c) 1000 μF + 150 Ω sag waveform (TG-7/1 output, H-bar)

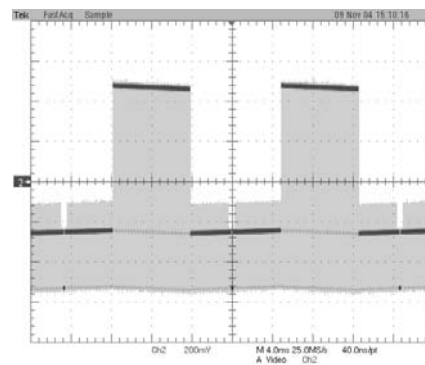
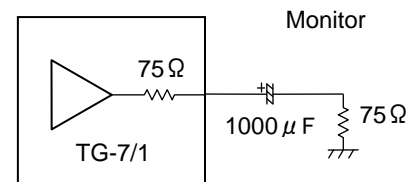

Fig. 10



● Application Circuit Example

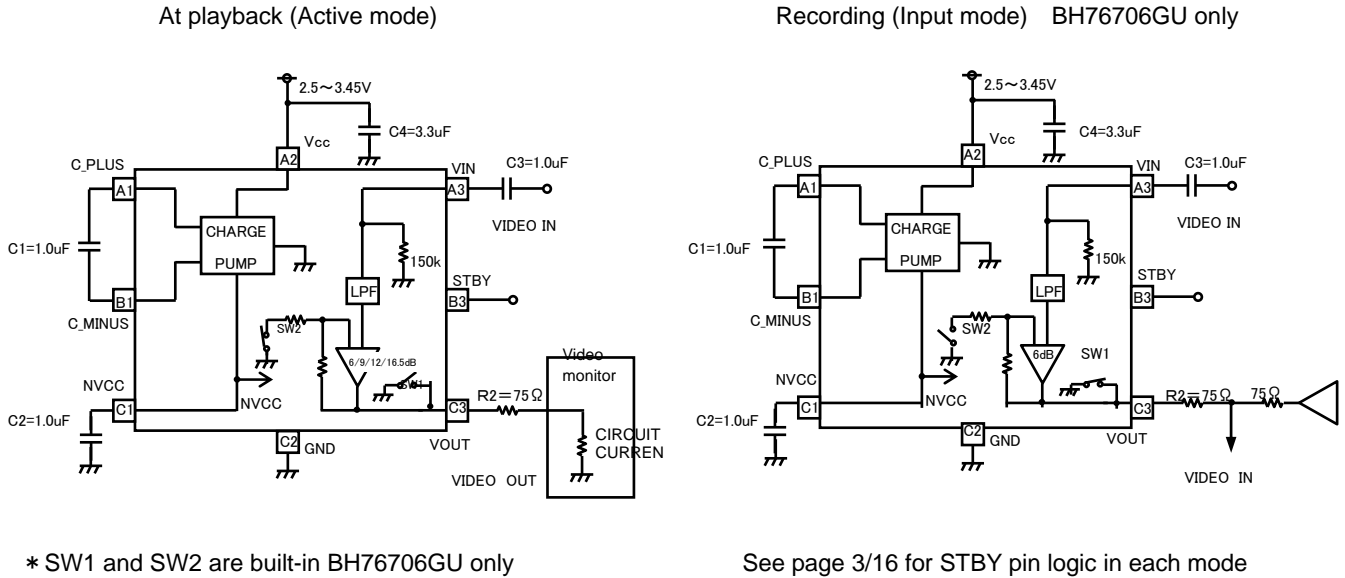

Fig.11

※ We are confident in recommending the above application circuit example, but we ask that you carefully check not just the static characteristics but also transient characteristics of this circuit before using it.

● Caution on use

1. Wiring from the decoupling capacitor C4 to the IC should be kept as short as possible. Moreover, this capacitor's capacitance value may have ripple effects on the IC, and may affect the S-N ratio for signals, so we recommend using as large a decoupling capacitor as possible. (Recommended C4: 3.3 μ F, B characteristics, 6.3 V or higher maximum voltage)
Make mount board patterns follow the layout example shown on page 10 as closely as possible.
2. Capacitors to use
In view of the temperature characteristics, etc., we recommend a ceramic capacitor with B characteristics.
3. The NVCC (C1 pin) terminal generates a voltage that is used within the IC, so it should never be connected to a load unless absolutely necessary. Moreover, this capacitor (C2) has a large capacitance value but very little negative voltage ripple.
(Recommended C2: 1.0 μ F, B characteristic, 6.3 V or higher maximum voltage)
4. Capacitors C1 and C4 should be placed as close as possible to the IC. If the wiring to the capacitor is too long, it can lead to intrusion of switching noise. (Recommended C1: 1.0 μ F, B characteristics, 6.3 V or higher maximum voltage)
5. The HPF consists of input coupling capacitor C3 and 150 k Ω of internal input impedance. Be sure to check for video signal sag before determining the C3 value. The cut-off frequency f_c can be calculated using the following formula.
 $f_c = 1/(2\pi \times C3 \times 150k\Omega)$ (Recommended C3: 1.0 μ F, B characteristic, 6.3 V or higher maximum voltage)
6. The output resistor R2 should be placed close to the IC.
7. If the IC is mounted in the wrong direction, there is a risk of damage due to problems such as inverting VCC and GND. Be careful when mounting it.
8. A large current transition occurs in the power supply pin when the charge pump circuit is switched. If this affects other ICs (via the power supply line), insert a resistor (approximately 10 Ω) in the VCC line to improve the power supply's ripple effects. Although inserting a 10 Ω resistor lowers the voltage by about 0.2 V, this IC has a wide margin for low-voltage operation, so dynamic range problems or other problems should not occur. (See Figures 12 to 14.)

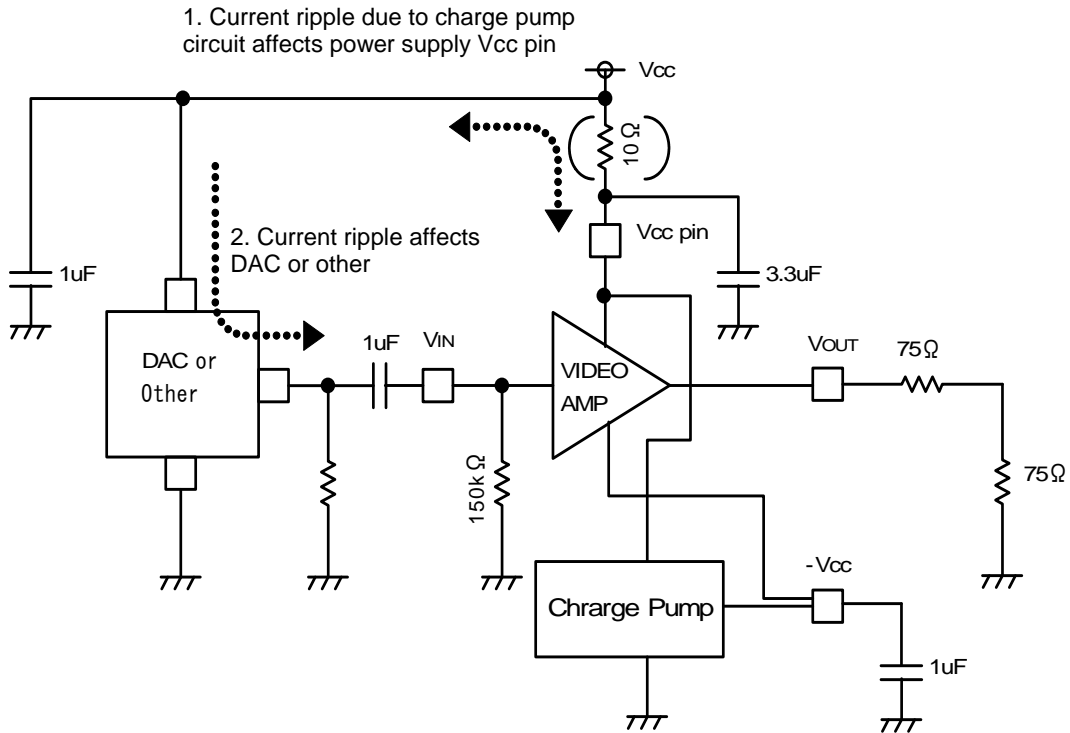
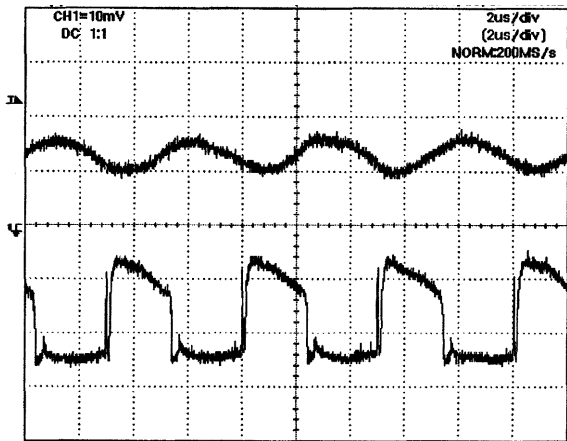

Fig.12 Effects of Charge Pump Circuit Current Ripple on External Circuit

1) Decoupling capacitor only



Waveform of current between power supply and capacitor (A)
10 mA/div

Waveform of current between capacitor and IC (B)
10 mA/div

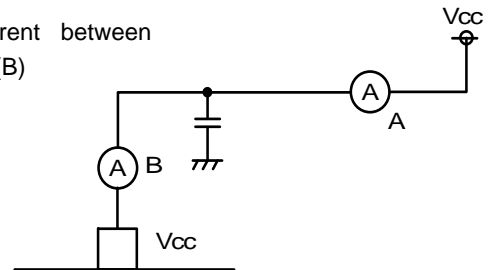
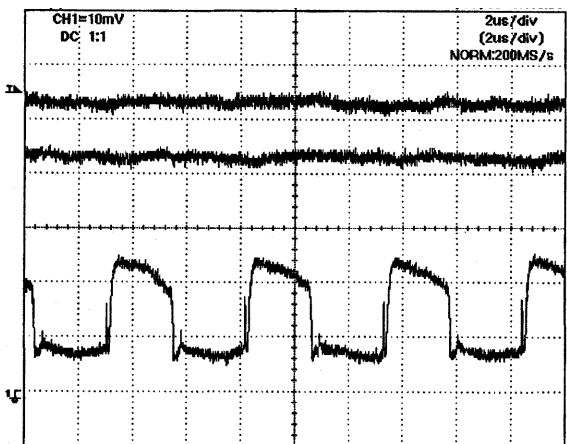

Fig.13

2) Decoupling capacitor + 10 Ohm resistor



Waveform of current between power supply and capacitor (A)
10 mA/div

Waveform of current between resistor and capacitor (B)
10 mA/div

Waveform of current between capacitor and IC (C)
10 mA/div

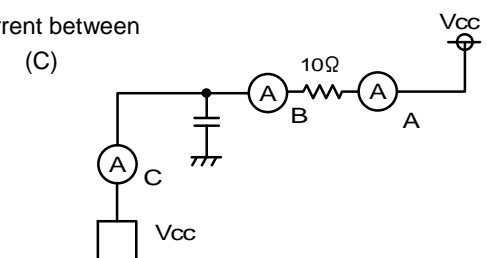
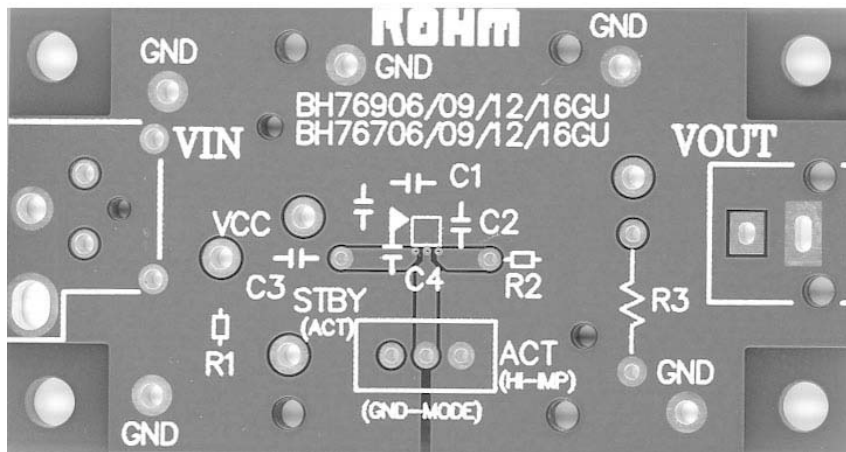
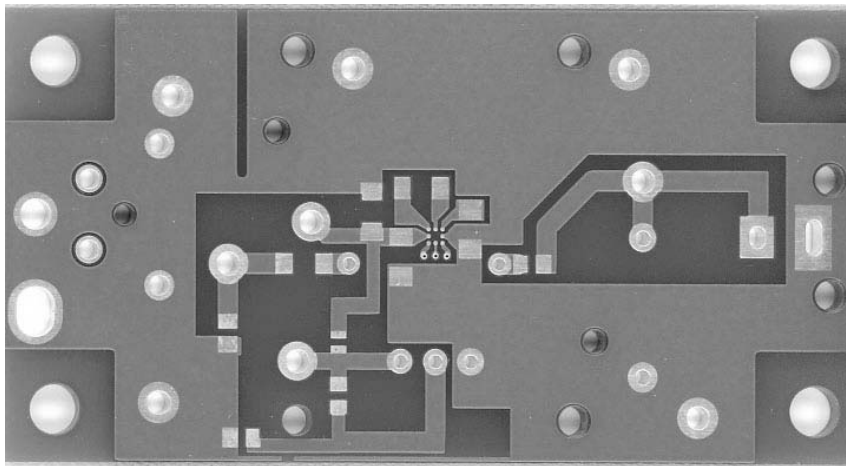

Fig.14

● Evaluation Board Pattern Diagram (Double-sided, 2 layers)



Layer 1 wiring + Silkscreen legend



Layer 2 wiring

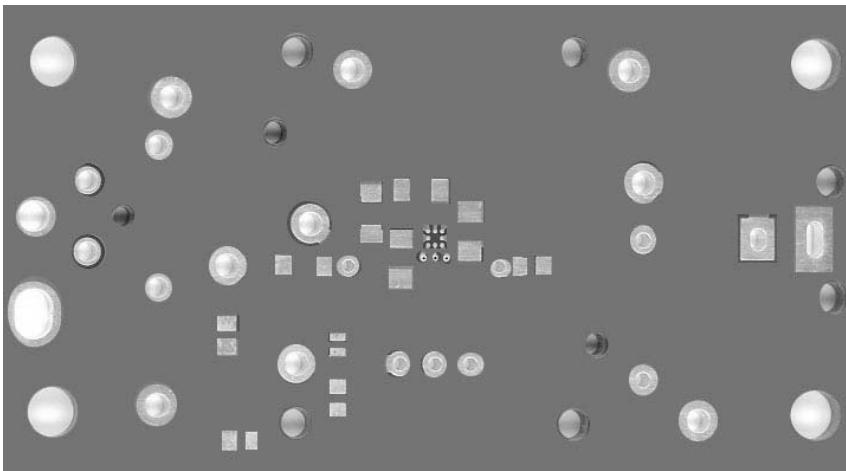

Solder pattern

Fig.15

Parts List

Symbol	Function	Recommended Value	Remarks
C1	Flying capacitor	1 μ F	B characteristic recommended
C2	Tank capacitor	1 μ F	B characteristic recommended
C3	Input coupling capacitor	1 μ F	B characteristic recommended
C4	Decoupling capacitor	3.3 μ F	B characteristic recommended
R1	Input termination resistor	75 Ω	Needed when connected to video signal measurement set
R2	Output resistor	75 Ω	—
R3	Output termination resistor	75 Ω	Not needed when connected to TV or video signal measurement set
	Input connector	BNC	
	Output connector	RCA (Pin jack)	

●Reference Data

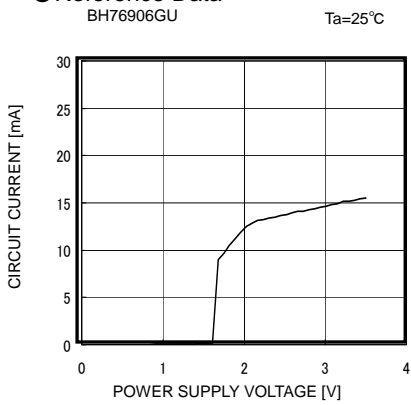

Fig. 16 Circuit Current vs Supply Voltage

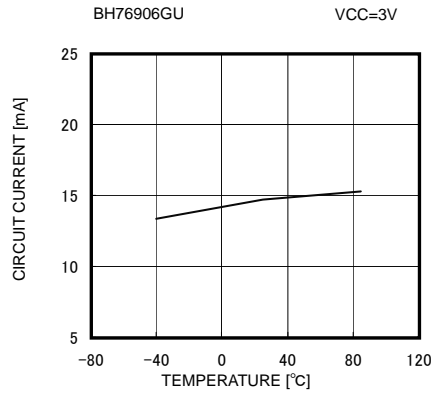

Fig. 17 Circuit Current vs Ambient Temperature

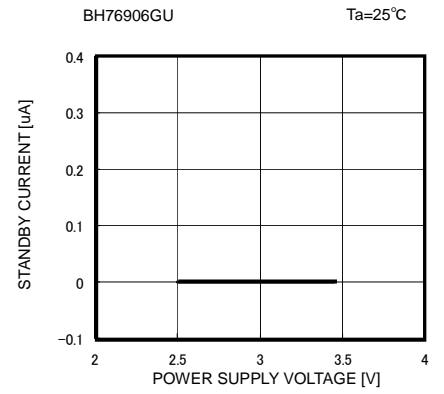

Fig. 18 Standby Circuit Current vs Supply Voltage

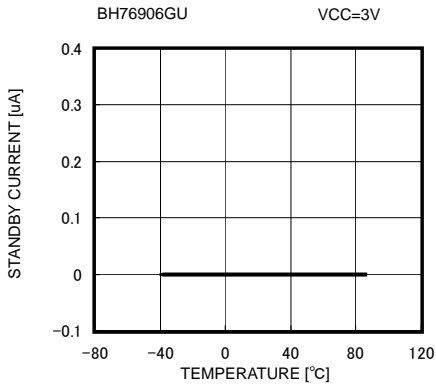

Fig. 19 Standby Circuit Current vs Ambient Temperature

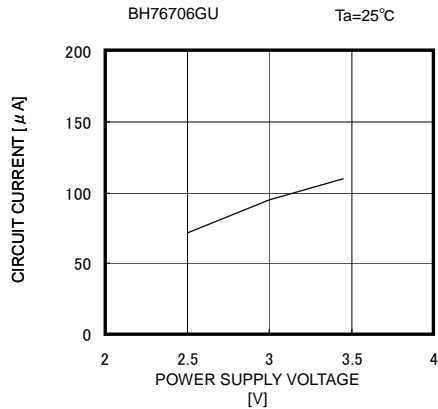

Fig. 20 GND Mode Circuit Current vs Supply Voltage

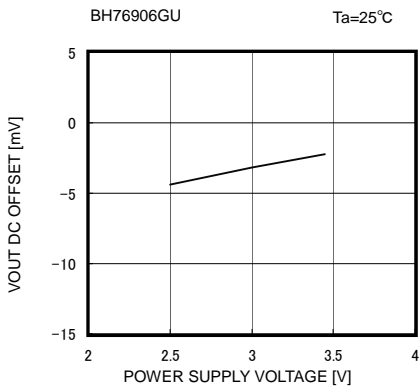
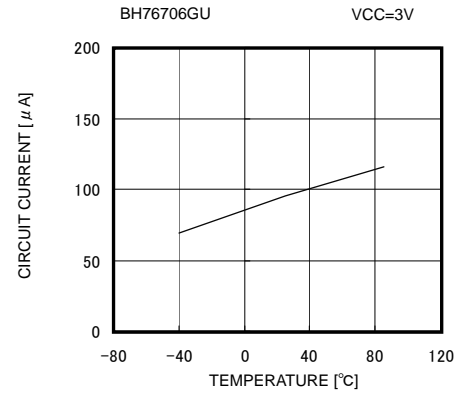

Fig. 22 VOUT Pin Output DC Offset vs Supply Voltage

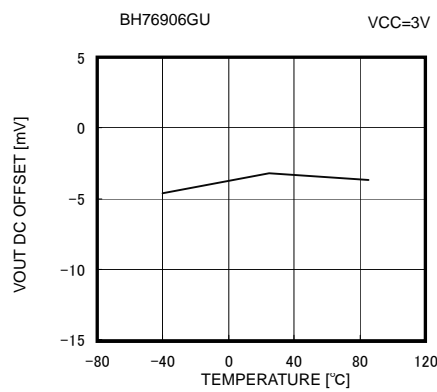

Fig. 23 VOUT Pin Output DC Offset vs Ambient Temperature

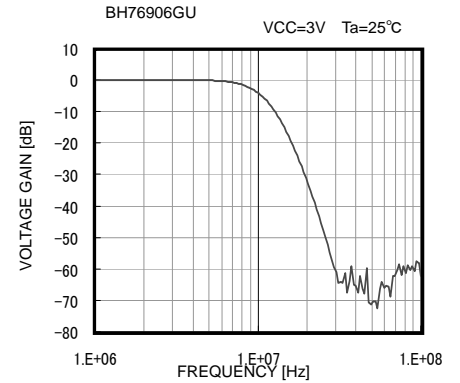

Fig. 24 Frequency Characteristic

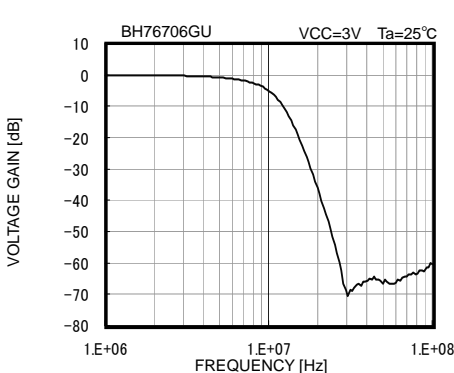

Fig. 25 Frequency Characteristic

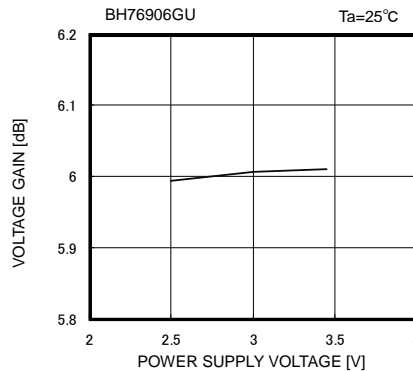

Fig. 26 Voltage Gain vs Supply Voltage

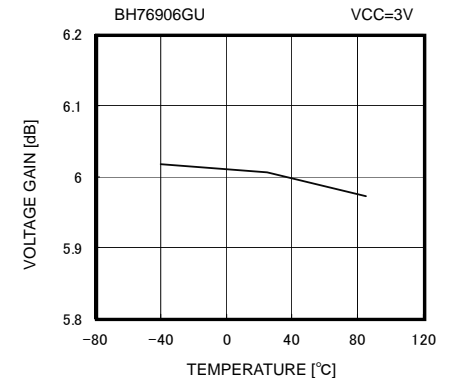

Fig. 27 Voltage Gain vs Ambient Temperature

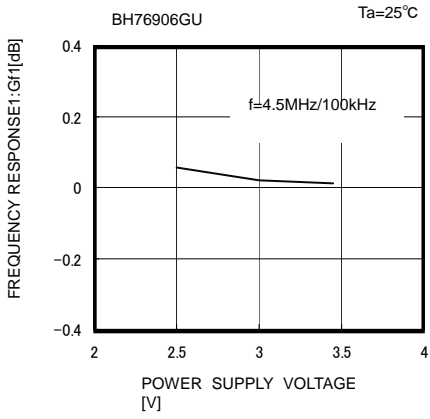

Fig. 28 Frequency Characteristic 1 vs Supply Voltage

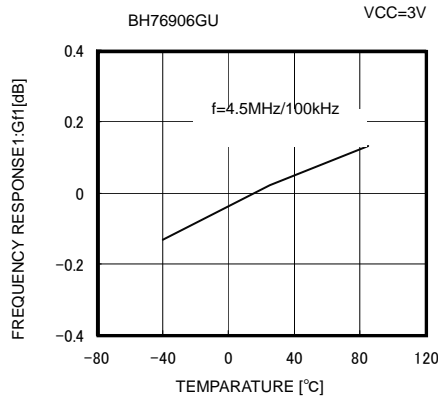

Fig. 29 Frequency Characteristic 1 vs Ambient Temperature

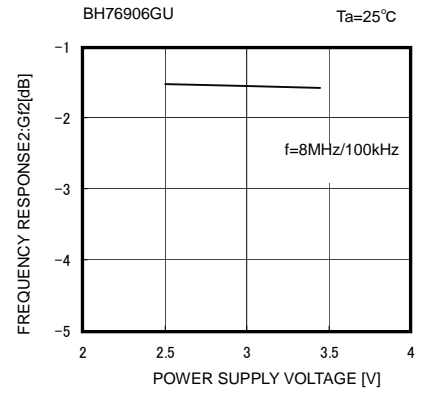

Fig. 30 Frequency Characteristic 2 vs Supply Voltage

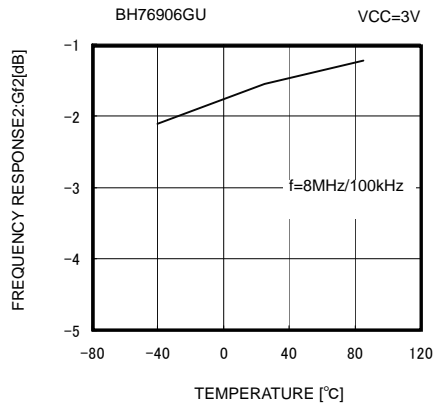

Fig. 31 Frequency Characteristic 2 vs Ambient Temperature

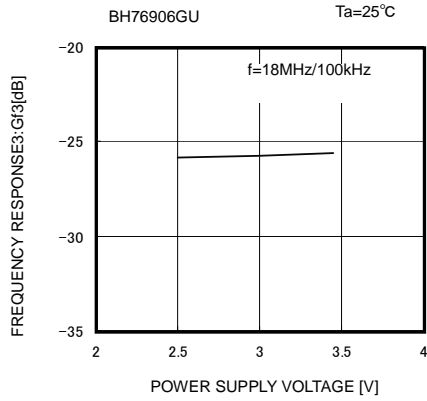

Fig. 32 Frequency Characteristic 3 vs Supply Voltage

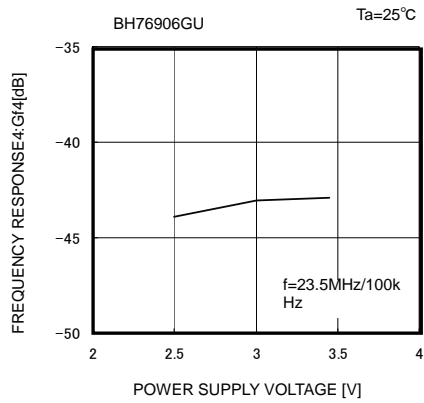
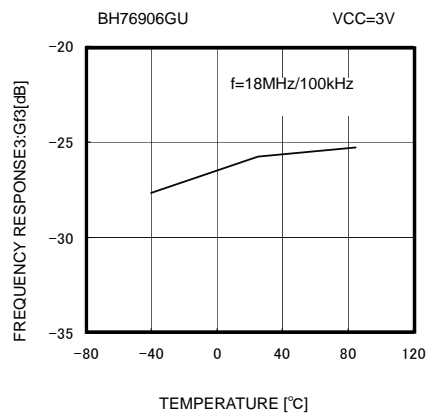

Fig. 34 Frequency Characteristic 4 vs Supply Voltage

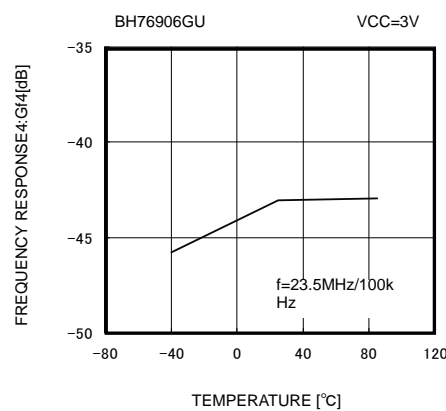

Fig. 35 Frequency Characteristic 4 vs Ambient Temperature

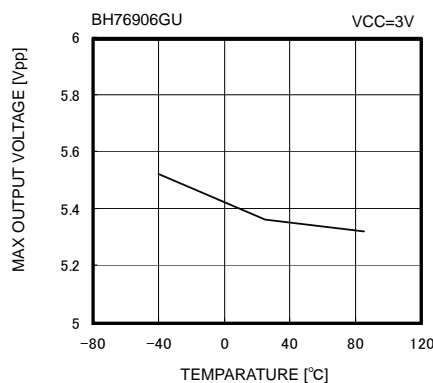

Fig. 37 Max. Output Level vs Ambient Temperature

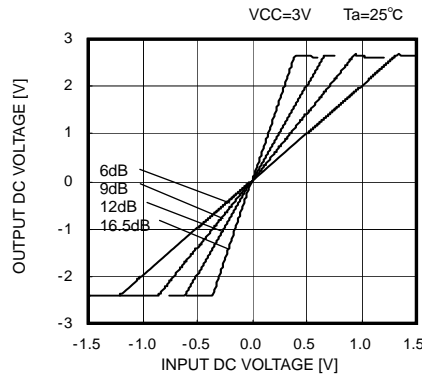

Fig. 38 DC I/O Characteristic

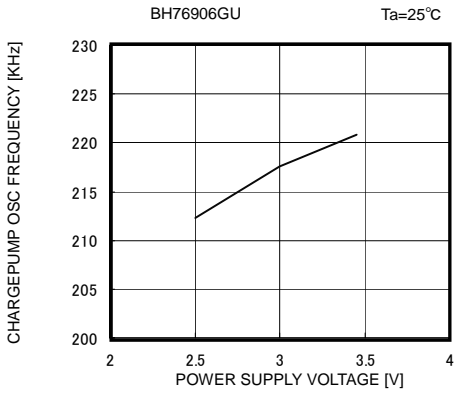

Fig. 39 Charge Pump Oscillation Frequency vs Supply Voltage

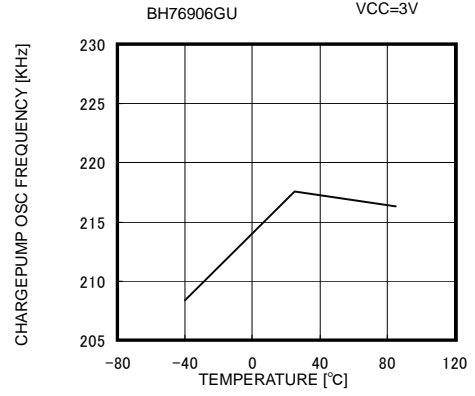

Fig. 40 Charge Pump Oscillation Frequency vs Ambient Temperature

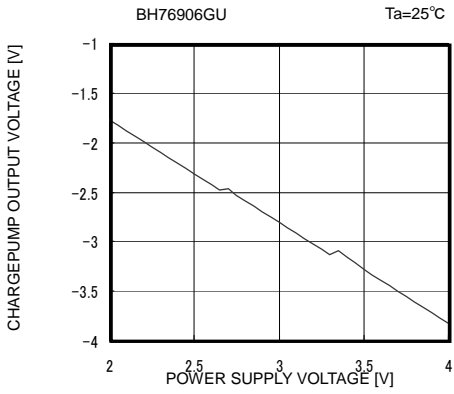

Fig. 41 Charge Pump Output Voltage vs Supply Voltage

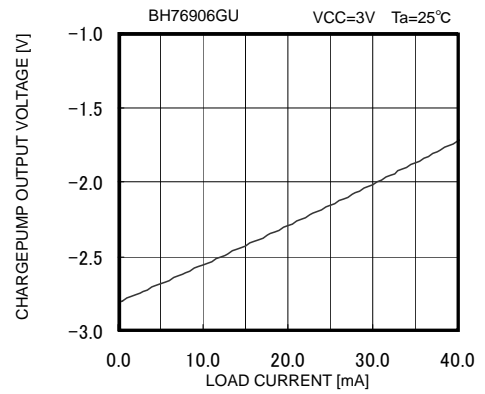

Fig. 42 Charge Pump Load Regulation

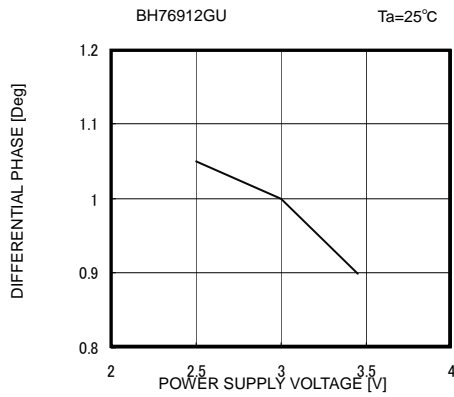

Fig. 43 Differential Phase vs Supply Voltage

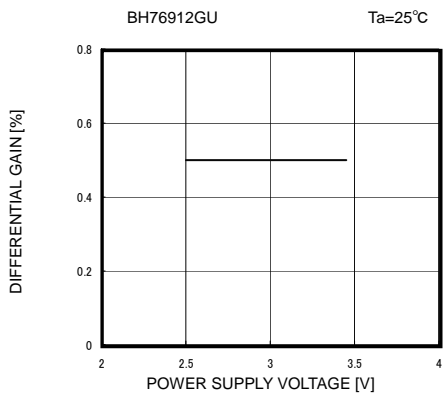
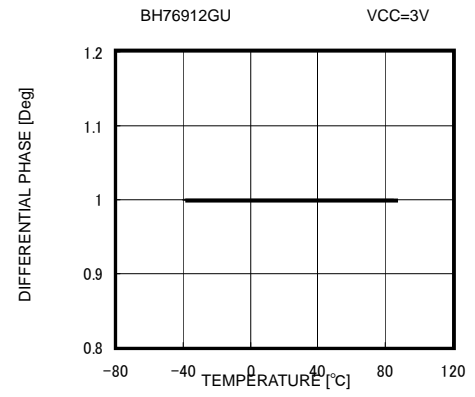

Fig. 45 Differential Gain vs Supply Voltage

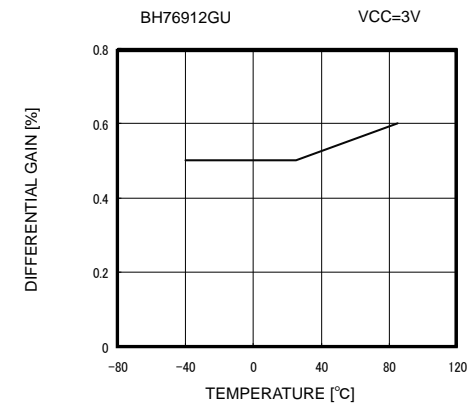

Fig. 46 Differential Gain vs Ambient Temperature

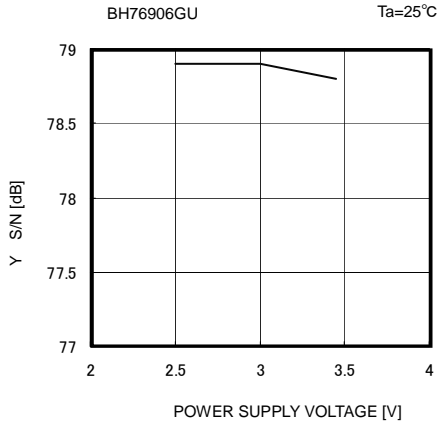

Fig. 47 Y S/N vs Supply Voltage

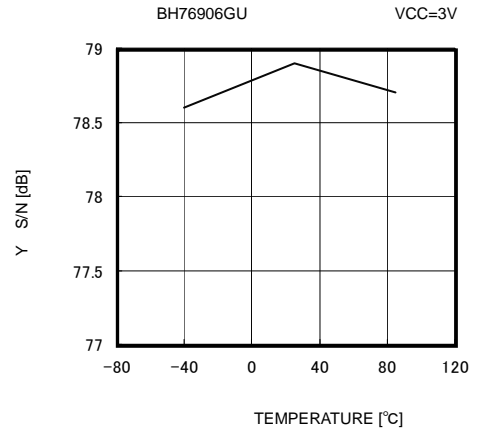

Fig. 48 Y S/N vs Ambient Temperature

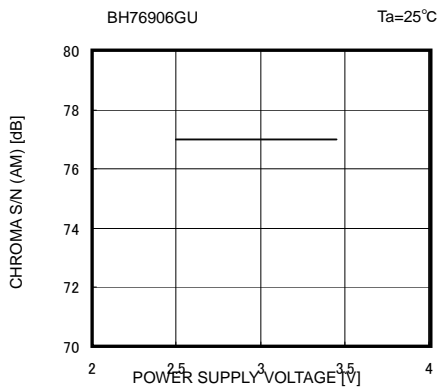

Fig. 49 C AM S/N vs Supply Voltage

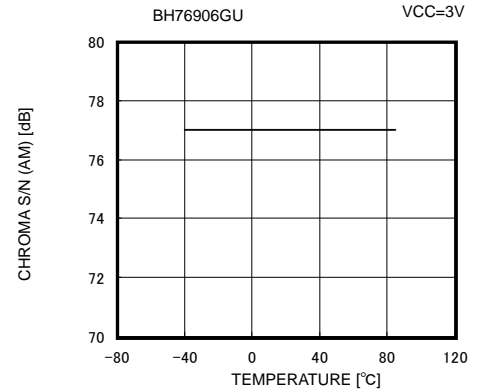

Fig. 50 C AM S/N vs Ambient Temperature

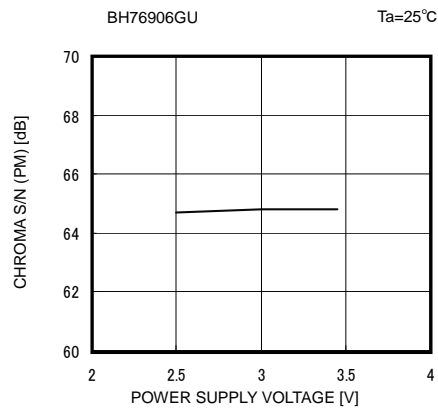

Fig. 51 C PM S/N vs Supply Voltage

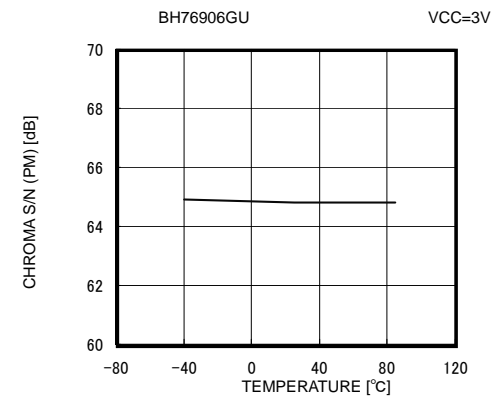

Fig. 52 C PM S/N vs Ambient Temperature

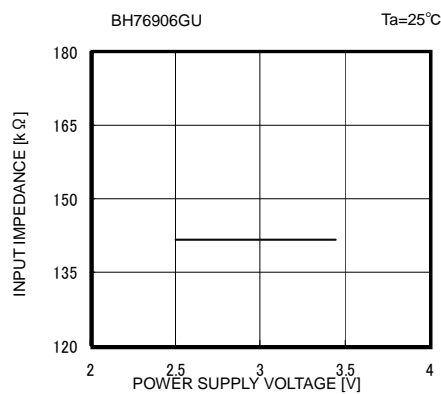

Fig. 53 Input Impedance vs Supply Voltage

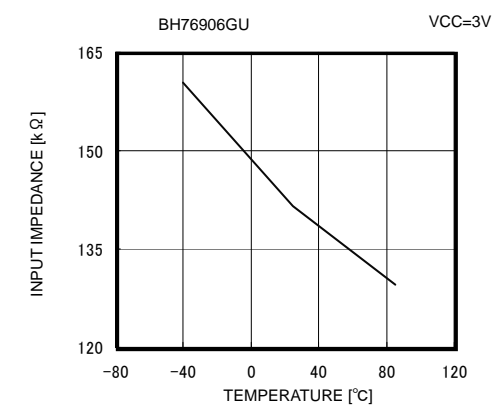

Fig. 54 Input Impedance vs Ambient Temperature

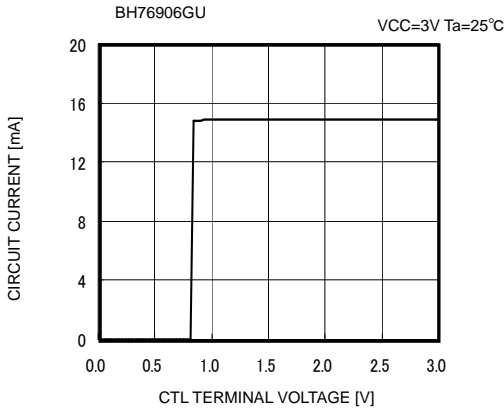

Fig. 55 Control Pin Characteristic

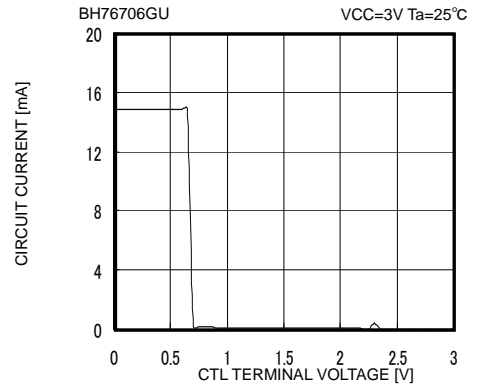

Fig. 56 Control Pin Characteristic

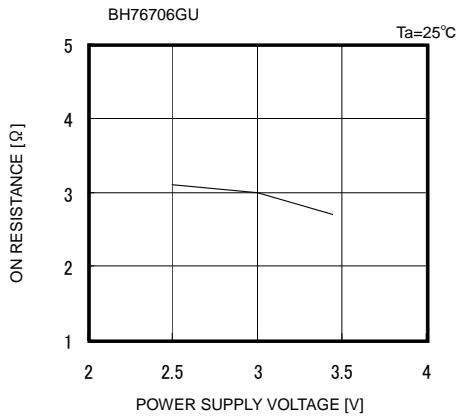

Fig. 57 Output Pin Shunt Switch On Resistance vs Supply Voltage

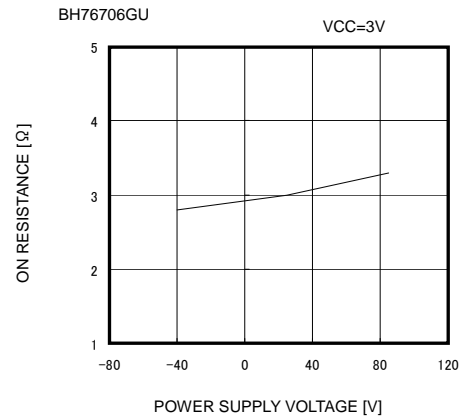

Fig. 58 Output Pin Shunt Switch On Resistance vs Ambient Temperature

● Performing separate electrostatic damage countermeasures

When adding an externally attached electrostatic countermeasure element to the output pin, connect a varistor in the position shown in Fig. 59 (if connected directly to the output pin, the IC could oscillate depending on the capacity of the varistor). For this IC, since the output waveform is GND-referenced and swings positive and negative, a normal Zener diode cannot be used.

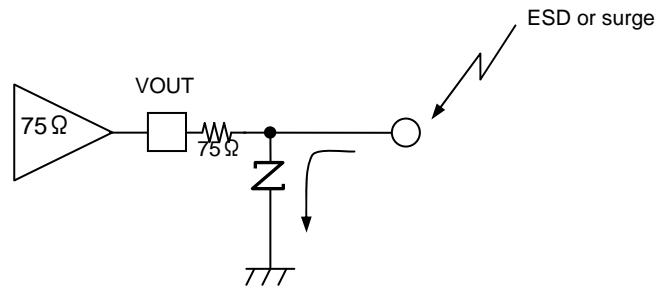
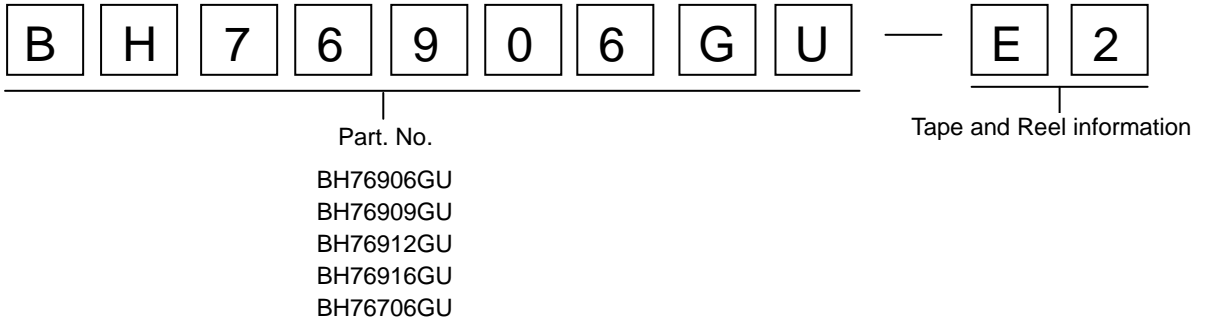
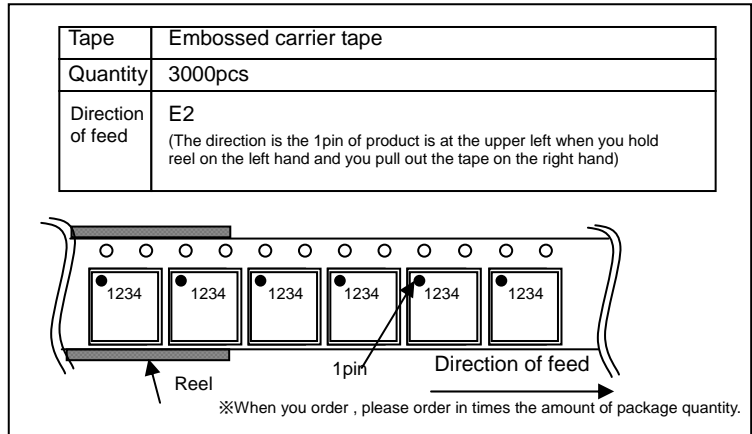
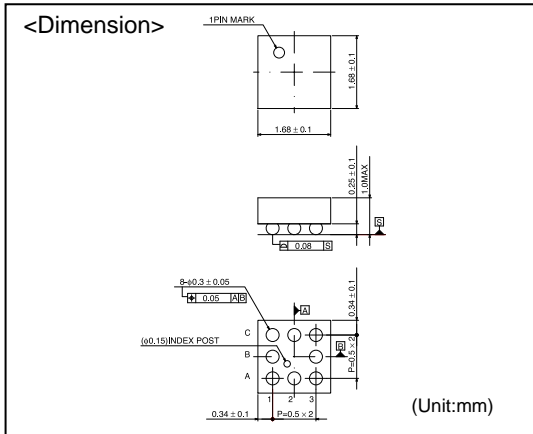

Fig.59 Using Externally Attached Varistor

● Selection of order type



VCSP85H1



Notice

Precaution on using ROHM Products

- Our Products are designed and manufactured for application in ordinary electronic equipments (such as AV equipment, OA equipment, telecommunication equipment, home electronic appliances, amusement equipment, etc.). If you intend to use our Products in devices requiring extremely high reliability (such as medical equipment ^(Note 1), transport equipment, traffic equipment, aircraft/spacecraft, nuclear power controllers, fuel controllers, car equipment including car accessories, safety devices, etc.) and whose malfunction or failure may cause loss of human life, bodily injury or serious damage to property ("Specific Applications"), please consult with the ROHM sales representative in advance. Unless otherwise agreed in writing by ROHM in advance, ROHM shall not be in any way responsible or liable for any damages, expenses or losses incurred by you or third parties arising from the use of any ROHM's Products for Specific Applications.

(Note1) Medical Equipment Classification of the Specific Applications

JAPAN	USA	EU	CHINA
CLASS III	CLASS III	CLASS II b	CLASS III
CLASS IV		CLASS III	

- ROHM designs and manufactures its Products subject to strict quality control system. However, semiconductor products can fail or malfunction at a certain rate. Please be sure to implement, at your own responsibilities, adequate safety measures including but not limited to fail-safe design against the physical injury, damage to any property, which a failure or malfunction of our Products may cause. The following are examples of safety measures:
 - Installation of protection circuits or other protective devices to improve system safety
 - Installation of redundant circuits to reduce the impact of single or multiple circuit failure
- Our Products are designed and manufactured for use under standard conditions and not under any special or extraordinary environments or conditions, as exemplified below. Accordingly, ROHM shall not be in any way responsible or liable for any damages, expenses or losses arising from the use of any ROHM's Products under any special or extraordinary environments or conditions. If you intend to use our Products under any special or extraordinary environments or conditions (as exemplified below), your independent verification and confirmation of product performance, reliability, etc. prior to use, must be necessary:
 - Use of our Products in any types of liquid, including water, oils, chemicals, and organic solvents
 - Use of our Products outdoors or in places where the Products are exposed to direct sunlight or dust
 - Use of our Products in places where the Products are exposed to sea wind or corrosive gases, including Cl₂, H₂S, NH₃, SO₂, and NO₂
 - Use of our Products in places where the Products are exposed to static electricity or electromagnetic waves
 - Use of our Products in proximity to heat-producing components, plastic cords, or other flammable items
 - Sealing or coating our Products with resin or other coating materials
 - Use of our Products without cleaning residue of flux (even if you use no-clean type fluxes, cleaning residue of flux is recommended); or Washing our Products by using water or water-soluble cleaning agents for cleaning residue after soldering
 - Use of the Products in places subject to dew condensation
- The Products are not subject to radiation-proof design.
- Please verify and confirm characteristics of the final or mounted products in using the Products.
- In particular, if a transient load (a large amount of load applied in a short period of time, such as pulse. is applied, confirmation of performance characteristics after on-board mounting is strongly recommended. Avoid applying power exceeding normal rated power; exceeding the power rating under steady-state loading condition may negatively affect product performance and reliability.
- De-rate Power Dissipation (Pd) depending on Ambient temperature (Ta). When used in sealed area, confirm the actual ambient temperature.
- Confirm that operation temperature is within the specified range described in the product specification.
- ROHM shall not be in any way responsible or liable for failure induced under deviant condition from what is defined in this document.

Precaution for Mounting / Circuit board design

- When a highly active halogenous (chlorine, bromine, etc.) flux is used, the residue of flux may negatively affect product performance and reliability.
- In principle, the reflow soldering method must be used; if flow soldering method is preferred, please consult with the ROHM representative in advance.

For details, please refer to ROHM Mounting specification

Precautions Regarding Application Examples and External Circuits

1. If change is made to the constant of an external circuit, please allow a sufficient margin considering variations of the characteristics of the Products and external components, including transient characteristics, as well as static characteristics.
2. You agree that application notes, reference designs, and associated data and information contained in this document are presented only as guidance for Products use. Therefore, in case you use such information, you are solely responsible for it and you must exercise your own independent verification and judgment in the use of such information contained in this document. ROHM shall not be in any way responsible or liable for any damages, expenses or losses incurred by you or third parties arising from the use of such information.

Precaution for Electrostatic

This Product is electrostatic sensitive product, which may be damaged due to electrostatic discharge. Please take proper caution in your manufacturing process and storage so that voltage exceeding the Products maximum rating will not be applied to Products. Please take special care under dry condition (e.g. Grounding of human body / equipment / solder iron, isolation from charged objects, setting of ionizer, friction prevention and temperature / humidity control).

Precaution for Storage / Transportation

1. Product performance and soldered connections may deteriorate if the Products are stored in the places where:
 - [a] the Products are exposed to sea winds or corrosive gases, including Cl₂, H₂S, NH₃, SO₂, and NO₂
 - [b] the temperature or humidity exceeds those recommended by ROHM
 - [c] the Products are exposed to direct sunshine or condensation
 - [d] the Products are exposed to high Electrostatic
2. Even under ROHM recommended storage condition, solderability of products out of recommended storage time period may be degraded. It is strongly recommended to confirm solderability before using Products of which storage time is exceeding the recommended storage time period.
3. Store / transport cartons in the correct direction, which is indicated on a carton with a symbol. Otherwise bent leads may occur due to excessive stress applied when dropping of a carton.
4. Use Products within the specified time after opening a humidity barrier bag. Baking is required before using Products of which storage time is exceeding the recommended storage time period.

Precaution for Product Label

QR code printed on ROHM Products label is for ROHM's internal use only.

Precaution for Disposition

When disposing Products please dispose them properly using an authorized industry waste company.

Precaution for Foreign Exchange and Foreign Trade act

Since our Products might fall under controlled goods prescribed by the applicable foreign exchange and foreign trade act, please consult with ROHM representative in case of export.

Precaution Regarding Intellectual Property Rights

1. All information and data including but not limited to application example contained in this document is for reference only. ROHM does not warrant that foregoing information or data will not infringe any intellectual property rights or any other rights of any third party regarding such information or data. ROHM shall not be in any way responsible or liable for infringement of any intellectual property rights or other damages arising from use of such information or data.:
2. No license, expressly or implied, is granted hereby under any intellectual property rights or other rights of ROHM or any third parties with respect to the information contained in this document.

Other Precaution

1. This document may not be reprinted or reproduced, in whole or in part, without prior written consent of ROHM.
2. The Products may not be disassembled, converted, modified, reproduced or otherwise changed without prior written consent of ROHM.
3. In no event shall you use in any way whatsoever the Products and the related technical information contained in the Products or this document for any military purposes, including but not limited to, the development of mass-destruction weapons.
4. The proper names of companies or products described in this document are trademarks or registered trademarks of ROHM, its affiliated companies or third parties.

General Precaution

1. Before you use our Products, you are requested to carefully read this document and fully understand its contents. ROHM shall not be in any way responsible or liable for failure, malfunction or accident arising from the use of any ROHM's Products against warning, caution or note contained in this document.
2. All information contained in this document is current as of the issuing date and subject to change without any prior notice. Before purchasing or using ROHM's Products, please confirm the latest information with a ROHM sales representative.
3. The information contained in this document is provided on an "as is" basis and ROHM does not warrant that all information contained in this document is accurate and/or error-free. ROHM shall not be in any way responsible or liable for any damages, expenses or losses incurred by you or third parties resulting from inaccuracy or errors of or concerning such information.



Компания «ЭлектроПласт» предлагает заключение долгосрочных отношений при поставках импортных электронных компонентов на взаимовыгодных условиях!

Наши преимущества:

- Оперативные поставки широкого спектра электронных компонентов отечественного и импортного производства напрямую от производителей и с крупнейших мировых складов;
- Поставка более 17-ти миллионов наименований электронных компонентов;
- Поставка сложных, дефицитных, либо снятых с производства позиций;
- Оперативные сроки поставки под заказ (от 5 рабочих дней);
- Экспресс доставка в любую точку России;
- Техническая поддержка проекта, помощь в подборе аналогов, поставка прототипов;
- Система менеджмента качества сертифицирована по Международному стандарту ISO 9001;
- Лицензия ФСБ на осуществление работ с использованием сведений, составляющих государственную тайну;
- Поставка специализированных компонентов (Xilinx, Altera, Analog Devices, Intersil, Interpoint, Microsemi, Aeroflex, Peregrine, Syfer, Eurofarad, Texas Instrument, Miteq, Cobham, E2V, MA-COM, Hittite, Mini-Circuits, General Dynamics и др.);

Помимо этого, одним из направлений компании «ЭлектроПласт» является направление «Источники питания». Мы предлагаем Вам помощь Конструкторского отдела:

- Подбор оптимального решения, техническое обоснование при выборе компонента;
- Подбор аналогов;
- Консультации по применению компонента;
- Поставка образцов и прототипов;
- Техническая поддержка проекта;
- Защита от снятия компонента с производства.



Как с нами связаться

Телефон: 8 (812) 309 58 32 (многоканальный)

Факс: 8 (812) 320-02-42

Электронная почта: org@eplast1.ru

Адрес: 198099, г. Санкт-Петербург, ул. Калинина, дом 2, корпус 4, литера А.