



Package Style: CJ2BAT0



Features

- DC to 3.0GHz Operation
- Internally Matched Input and Output
- 15dB Small Signal Gain
- 4.8dB Noise Figure at 900MHz
- 38dBm Output IP3 at 900MHz
- Single 9V to 12V Power Supply

Applications

- CATV Distribution Amplifiers
- Cable Modems
- Broadband Gain Blocks
- Laser Diode Driver
- Return Channel Amplifier
- Base Stations

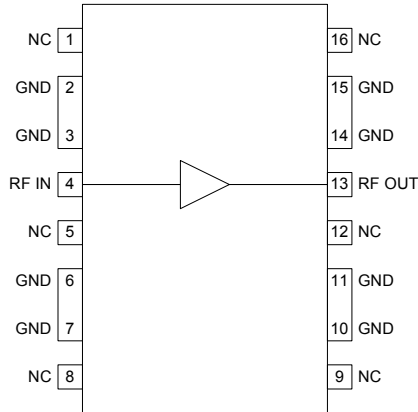

Functional Block Diagram

Product Description

The RF2317 is a general purpose, low-cost high-linearity RF amplifier IC. The device is manufactured on an advanced gallium arsenide heterojunction bipolar transistor (HBT) process, and has been designed for use as an easily cascadable 75Ω gain block. The gain flatness of better than ±0.5dB from 50MHz to 1000MHz, and the high linearity, make this part ideal for cable TV applications. Other applications include IF and RF amplification in wireless voice and data communication products operating in frequency bands up to 3GHz. The device is self-contained with 75Ω input and output impedances and requires only two external DC biasing elements to operate as specified.

Ordering Information

RF2317	Sample bag with 25 pieces
RF2317SR	7" Sample reel with 100 pieces
RF2317TR7	7" Reel with 750 pieces
RF2317TR13	13" Reel with 2500 pieces
RF2317 50Ω	1000MHz PCBA with 5-piece sample bag
RF2317 75Ω	1000MHz PCBA with 5-piece sample bag

Optimum Technology Matching® Applied

- | | | | |
|--|--------------------------------------|-------------------------------------|------------------------------------|
| <input checked="" type="checkbox"/> GaAs HBT | <input type="checkbox"/> SiGe BiCMOS | <input type="checkbox"/> GaAs pHEMT | <input type="checkbox"/> GaN HEMT |
| <input type="checkbox"/> GaAs MESFET | <input type="checkbox"/> Si BiCMOS | <input type="checkbox"/> Si CMOS | <input type="checkbox"/> BIFET HBT |
| <input type="checkbox"/> InGaP HBT | <input type="checkbox"/> SiGe HBT | <input type="checkbox"/> Si BJT | |

Absolute Maximum Ratings

Parameter	Rating	Unit
Device Current	250	mA
Input RF Power	+18	dBm
Output Load VSWR	20:1	
Ambient Operating Temperature	-40 to +85	°C
Storage Temperature	-40 to +150	°C



Caution! ESD sensitive device.

Exceeding any one or a combination of the Absolute Maximum Rating conditions may cause permanent damage to the device. Extended application of Absolute Maximum Rating conditions to the device may reduce device reliability. Specified typical performance or functional operation of the device under Absolute Maximum Rating conditions is not implied.

The information in this publication is believed to be accurate and reliable. However, no responsibility is assumed by RF Micro Devices, Inc. ("RFMD") for its use, nor for any infringement of patents, or other rights of third parties, resulting from its use. No license is granted by implication or otherwise under any patent or patent rights of RFMD. RFMD reserves the right to change component circuitry, recommended application circuitry and specifications at any time without prior notice.



RFMD Green: RoHS compliant per EU Directive 2002/95/EC, halogen free per IEC 61249-2-21, < 1000 ppm each of antimony trioxide in polymeric materials and red phosphorus as a flame retardant, and <2% antimony in solder.

Parameter	Specification			Unit	Condition
	Min.	Typ.	Max.		
Overall (50Ω)					T = +25°C, I _{CC} = 180mA, R _C = 10.2Ω, 50Ω System
Frequency Range	DC		3000	MHz	3dB Bandwidth
Gain	13.5	14.3	15.0	dB	
Noise Figure		4.9		dB	From 100MHz to 1000MHz
Input VSWR		1.7:1			Appropriate values for the DC blocking capacitors and bias inductor are required to maintain this VSWR at the intended operating frequency range.
Output VSWR		2.3:1			
Output IP ₃		+47		dBm	At 100MHz
	+37	+42		dBm	At 500MHz
		+37		dBm	At 900MHz
Output IP ₂		+55		dBm	F ₁ = 400MHz, F ₂ = 500MHz, F _{OUT} = 100MHz
Output P1dB		+25.5		dBm	At 100MHz
		+24		dBm	At 500MHz
		+22		dBm	At 900MHz
Reverse Isolation		19.5		dB	
Thermal					
Theta _{JC}		55		°C/W	I _{CC} = 150mA, P _{DISS} = 1.2W, T _{AMB} = 85°C
Maximum Junction Temperature		150		°C	
Mean Time To Failures		3100		years	T _{AMB} = +85°C
Theta _{JC}		58		°C/W	I _{CC} = 180mA, P _{DISS} = 1.5W, T _{AMB} = 85°C
Maximum Junction Temperature		175		°C	
Mean Time To Failures		380		years	T _{AMB} = +85°C
Power Supply (50Ω)					
Device Voltage		8.5		V	On pin 13, I _{CC} = 150mA
		9.3		V	On pin 13, I _{CC} = 180mA
Operating Current Range	100	180	200	mA	Actual current determined by V _{CC} and R _C
Overall (75Ω)					T = 25°C, I _{CC} = 180mA, R _C = 14.3Ω, 75Ω System
Frequency Range	DC		3000	MHz	3dB Bandwidth
Gain		15.0		dB	
Noise Figure		4.8		dB	From 100MHz to 1000MHz

Parameter	Specification			Unit	Condition
	Min.	Typ.	Max.		
Overall (75Ω) (continued)					T = 25 °C, I _{CC} = 180mA, R _C = 14.3Ω, 75Ω System
Input VSWR		1.3:1			Appropriate values for the DC blocking capacitors and bias inductor are required to maintain this VSWR at the intended operating frequency range.
Output VSWR		1.8:1			
Output IP3		+49		dBm	At 100MHz
	+37	+43		dBm	At 500MHz
		+38		dBm	At 900MHz
Output IP2		+58		dBm	F ₁ = 400MHz, F ₂ = 500MHz, F _{OUT} = 100MHz
Output P1dB		+22		dBm	At 100MHz
		+22		dBm	At 500MHz
		+21		dBm	At 900MHz
Reverse Isolation		19		dB	
133 Channels					10dBmV per channel, flat, at the input of the amplifier; I _{CC} = 150mA, V _{CC} = 10.4V
XMOD		<-75		dBc	At 55.25MHz
		<-75		dBc	At 331.25MHz
		<-75		dBc	At 547.25MHz
		<-75		dBc	At 853.25MHz
CTB		-85		dBc	At 55.25MHz
		-85		dBc	At 331.25MHz
		-84		dBc	At 547.25MHz
		-83		dBc	At 853.25MHz
CSO + 1.25MHz		-90		dBc	At 55.25MHz
		-72		dBc	At 331.25MHz
		-69		dBc	At 853.25MHz
		-64		dBc	At 547.25MHz
CSO - 1.25MHz		-63		dBc	At 55.25MHz
		-65		dBc	At 331.25MHz
		-70		dBc	At 547.25MHz
		-90		dBc	At 853.25MHz
133 Channels					10dBmV per channel, flat, at the input of the amplifier; I _{CC} = 180mA, V _{CC} = 11.4V
XMOD		<-75		dBc	At 55.25MHz
		<-75		dBc	At 331.25MHz
		<-75		dBc	At 547.25MHz
		<-75		dBc	At 853.25MHz
CTB		-89		dBc	At 55.25MHz
		-86		dBc	At 331.25MHz
		-86		dBc	At 547.25MHz
		-84		dBc	At 853.25MHz
CSO + 1.25MHz		-89		dBc	At 55.25MHz
		-74		dBc	At 331.25MHz
		-69		dBc	At 853.25MHz
		-62		dBc	At 547.25MHz

CSO - 1.25MHz		-63		dBc	At 55.25MHz
		-65		dBc	At 331.25MHz
		-71		dBc	At 547.25MHz
		-91		dBc	At 853.25MHz
Power Supply (75Ω)					
Device Voltage		8.3		V	On pin 13, I _{CC} = 150mA
		8.9		V	On pin 13, I _{CC} = 180mA
Operating Current Range	100	180	200	mA	Actual current determined by V _{CC} and R _C

Pin Names and Descriptions

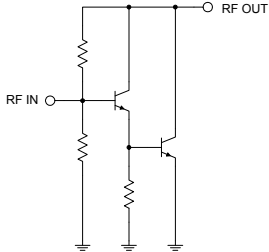
Pin	Name	Description	Interface Schematic
1	NC	This pin is internally not connected.	
2	GND	Ground connection. Keep traces physically short and connect immediately to ground plane for best performance. Each ground pin should have a via to the ground plane.	
3	GND	Same as pin 2.	
4	RF IN	RF input pin. This pin is NOT internally DC blocked. A DC blocking capacitor, suitable for the frequency of operation, should be used in most applications. DC coupling of the input is not allowed, because this will override the internal feedback loop and cause temperature instability.	
5	NC	This pin is internally not connected.	
6	GND	Same as pin 2.	
7	GND	Same as pin 2.	
8	NC	This pin is internally not connected.	
9	NC	This pin is internally not connected.	
10	GND	Same as pin 2.	
11	GND	Same as pin 2.	
12	NC	This pin is internally not connected.	
13	RF OUT	RF output and bias pin. Because DC is present on this pin, a DC blocking capacitor, suitable for the frequency of operation, should be used in most applications. For biasing, an RF choke in series with a resistor is needed. The DC voltage on this pin is typically 8.3V with a current of 150mA (for 75Ω board). See device voltage versus device current plot. In lower power applications the value of R_C can be increased to lower the current and V_D on this pin.	
14	GND	Same as pin 2.	
15	GND	Same as pin 2.	
16	NC	This pin is internally not connected.	

Package Drawing

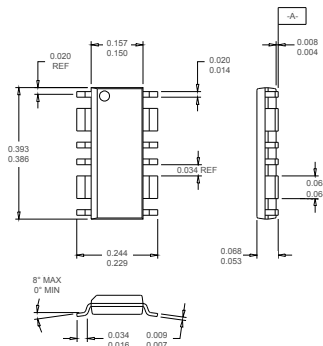

Application Schematic 5MHz to 50MHz Reverse Path

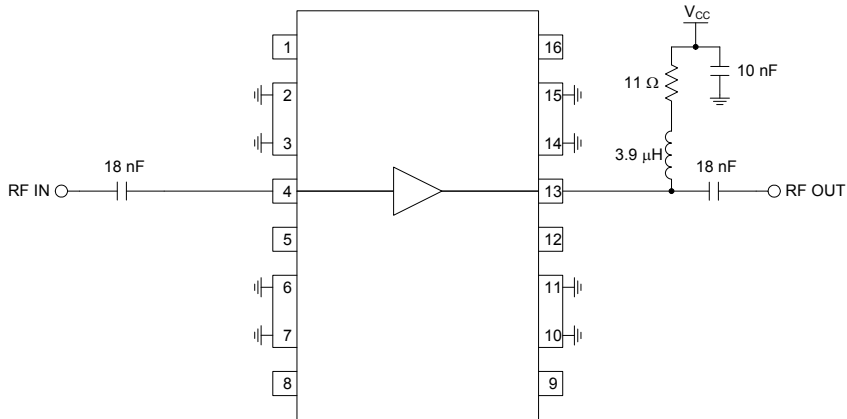

NOTES:
Gain Flatness <0.5 dB
Input and Output Return Loss >20 dB in 75 Ω system

Evaluation Board Schematic - 50Ω (Download [Bill of Materials](http://www.rfmd.com) from www.rfmd.com.)

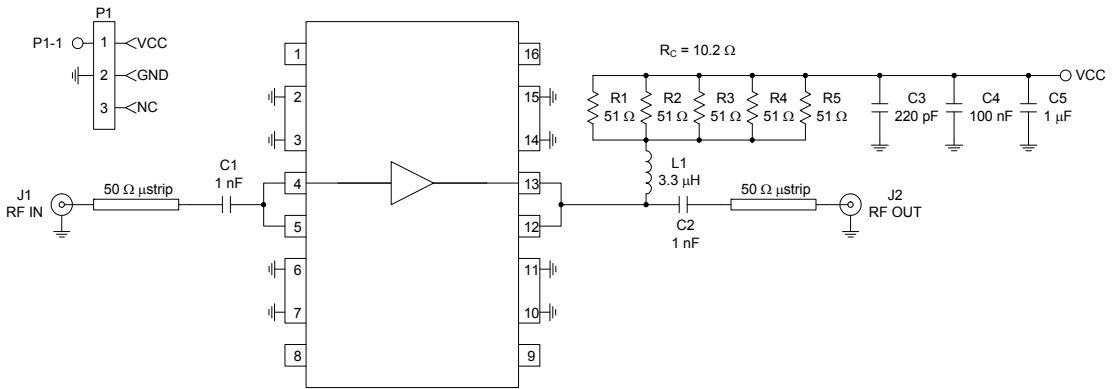

2317400 Rev -

Evaluation Board Schematic - 75Ω

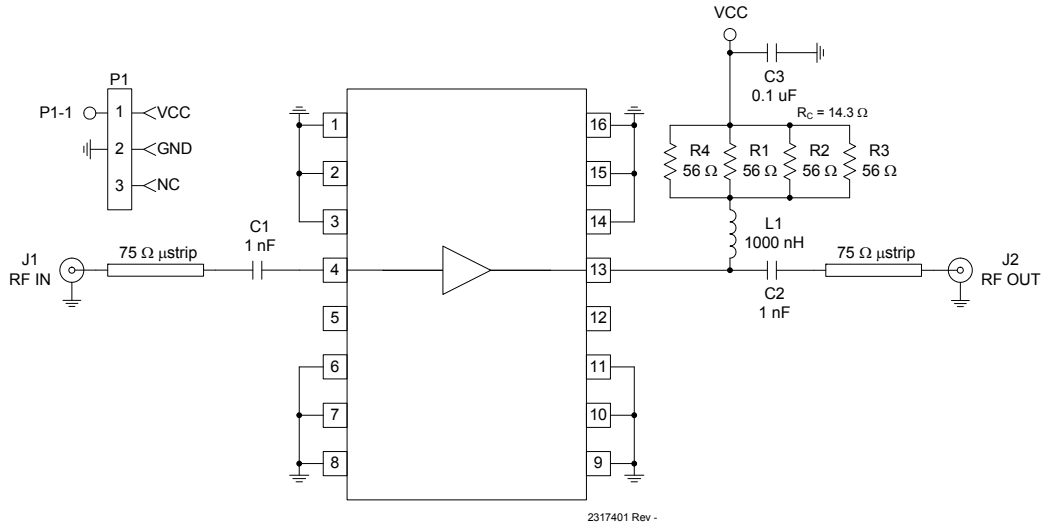

Evaluation Board Layout - 50Ω 2.0" x 2.0"

Board Thickness 0.031", Board Material FR-4

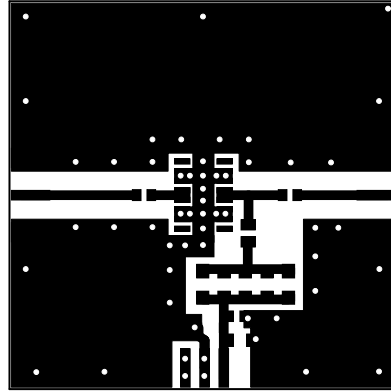
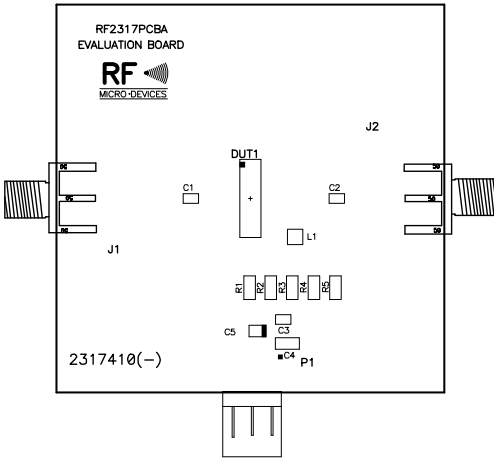

Evaluation Board Layout - 75Ω 1.40" x 1.40"

Board Thickness 0.062", Board Material FR-4

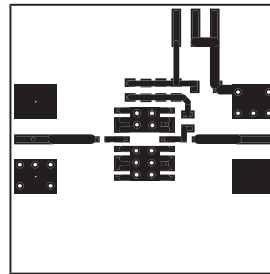
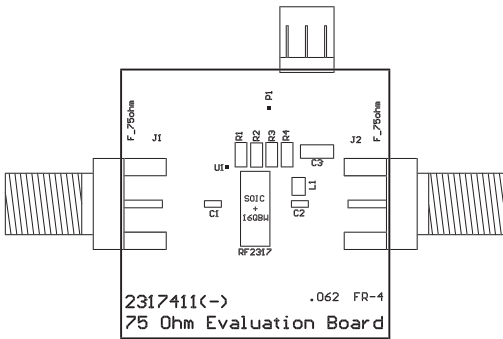

75Ω, I_{CC} = 150mA, Temp = +25°C

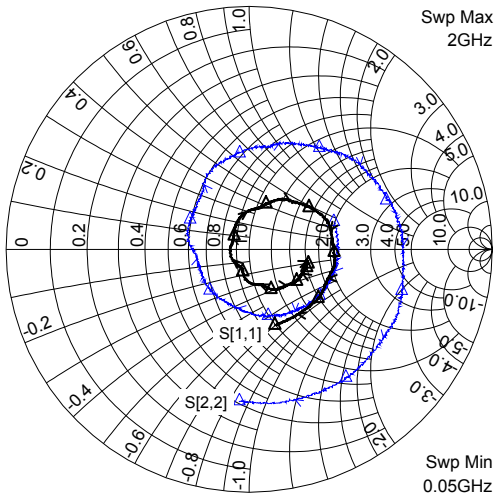

75Ω, I_{CC} = 180mA, Temp = +25°C

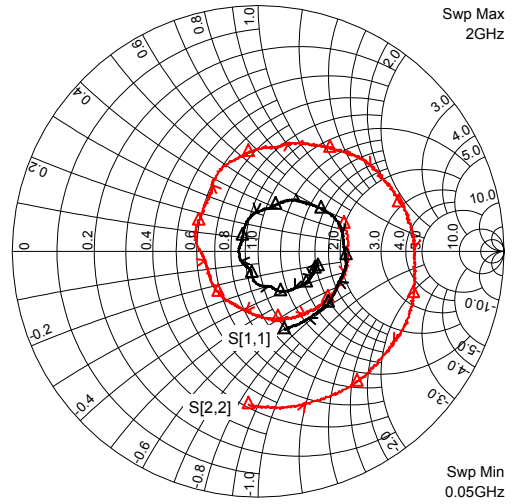

CSO (L) versus Channel Frequency Across Temperature
(133 Channels, $I_{CC} = 180$ mA)

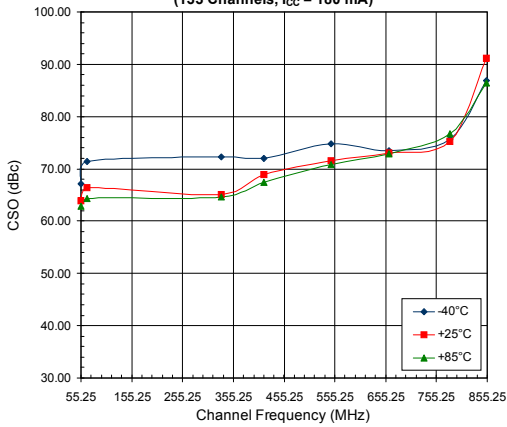

CSO (U) versus Channel Frequency Across Temperature
(133 Channels, $I_{CC} = 180$ mA)

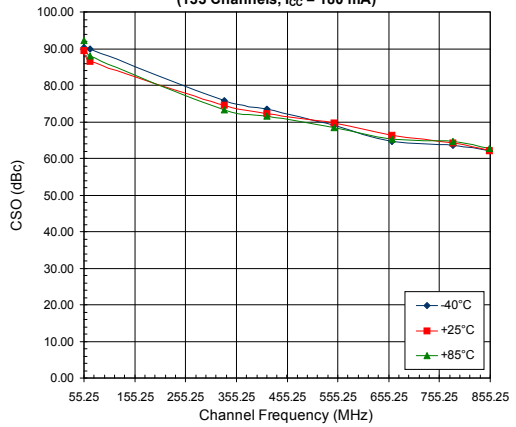

CTB versus Channel Frequency Across Temperature
(133 Channels, $I_{CC} = 180$ mA)

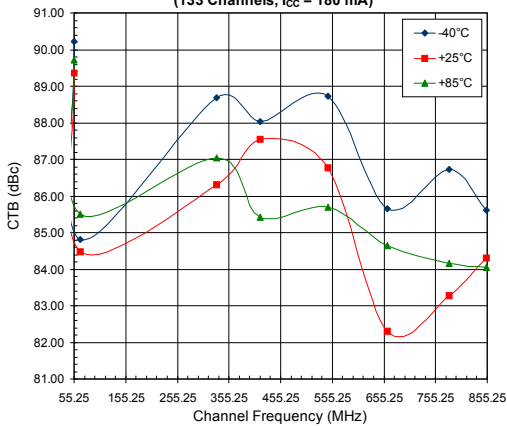

Gain versus Frequency
75Ω, I_{CC}=180mA

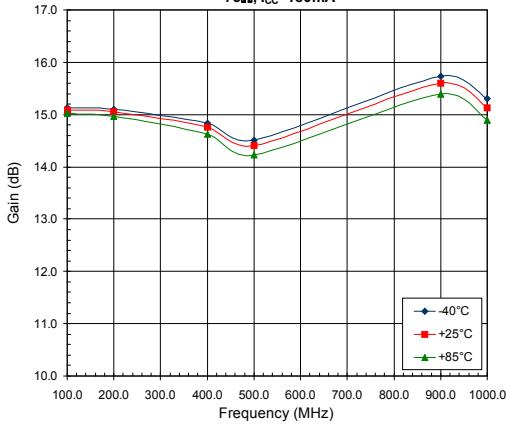

Noise Figure versus Frequency Over Temperature
75 Ω, I_{CC} = 180 mA

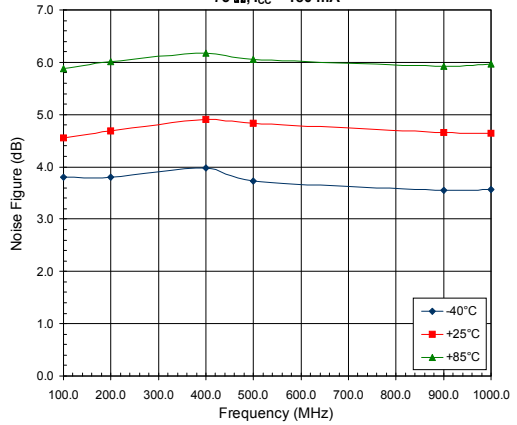

Device Voltage versus Current
75 Ω

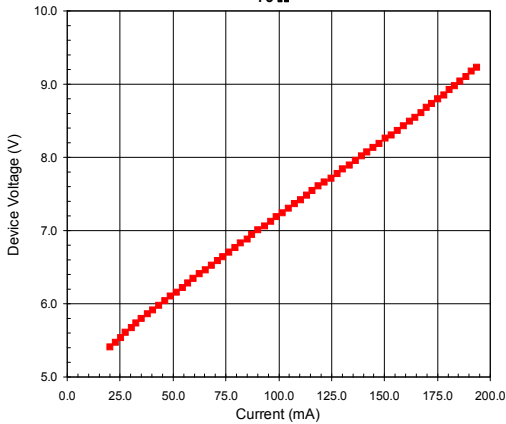

CSO (L) versus Channel Frequency Across Temperature
(133 Channels, I_{CC} = 150 mA)

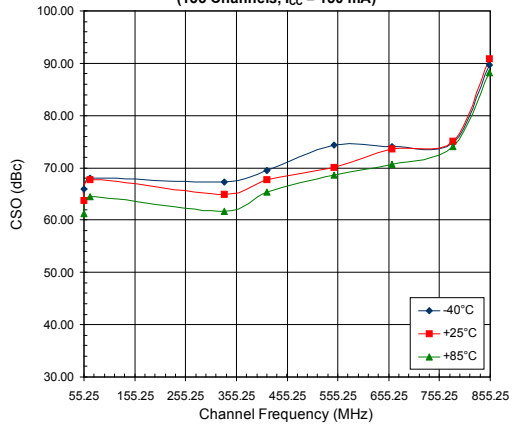

CSO (U) versus Channel Frequency Across Temperature
(133 Channels, I_{CC} = 150 mA)

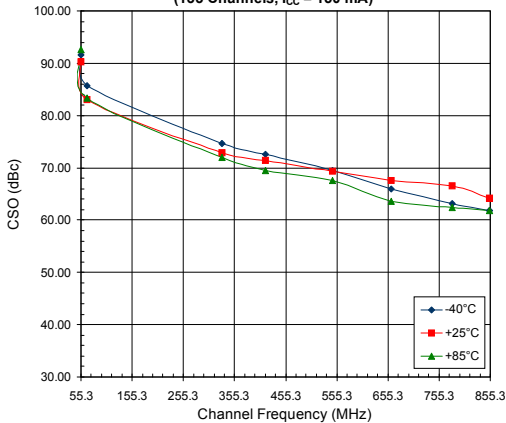

CTB versus Channel Frequency Across Temperature
(133 Channels, I_{CC} = 150 mA)

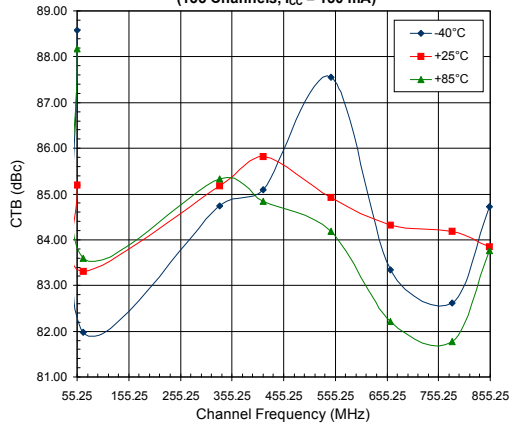



Компания «ЭлектроПласт» предлагает заключение долгосрочных отношений при поставках импортных электронных компонентов на взаимовыгодных условиях!

Наши преимущества:

- Оперативные поставки широкого спектра электронных компонентов отечественного и импортного производства напрямую от производителей и с крупнейших мировых складов;
- Поставка более 17-ти миллионов наименований электронных компонентов;
- Поставка сложных, дефицитных, либо снятых с производства позиций;
- Оперативные сроки поставки под заказ (от 5 рабочих дней);
- Экспресс доставка в любую точку России;
- Техническая поддержка проекта, помощь в подборе аналогов, поставка прототипов;
- Система менеджмента качества сертифицирована по Международному стандарту ISO 9001;
- Лицензия ФСБ на осуществление работ с использованием сведений, составляющих государственную тайну;
- Поставка специализированных компонентов (Xilinx, Altera, Analog Devices, Intersil, Interpoint, Microsemi, Aeroflex, Peregrine, Syfer, Eurofarad, Texas Instrument, Miteq, Cobham, E2V, MA-COM, Hittite, Mini-Circuits, General Dynamics и др.);

Помимо этого, одним из направлений компании «ЭлектроПласт» является направление «Источники питания». Мы предлагаем Вам помощь Конструкторского отдела:

- Подбор оптимального решения, техническое обоснование при выборе компонента;
- Подбор аналогов;
- Консультации по применению компонента;
- Поставка образцов и прототипов;
- Техническая поддержка проекта;
- Защита от снятия компонента с производства.



Как с нами связаться

Телефон: 8 (812) 309 58 32 (многоканальный)

Факс: 8 (812) 320-02-42

Электронная почта: org@eplast1.ru

Адрес: 198099, г. Санкт-Петербург, ул. Калинина, дом 2, корпус 4, литера А.