

MULTI-CON-X® FIELD INSTALLABLE CONNECTORS



Cable Pin
3X8X-XPB-XXX
Matching Mates:

- Cable-Cable
5X8X-XSB-XXX
- Panel
4XXX-XSB-XXX



Panel Mount
4X8X-XXB-XXX
Matching Mates:

- Cable Pin
3X8X-XPB-XXX
- Cable Socket
3X8X-XSB-XXX



P/C Tail Panel Mount
4XXX-XXB-XXX
Matching Mates:

- Cable Pin
3X8X-XPB-XXX
- Cable Socket
3X8X-XSB-XXX



Cable Socket
3X8X-XSB-XXX
Matching Mates:

- Cable-Cable
5X8X-XPB-XXX
- Panel
4XXX-XPB-XXX



Cable to Cable
5X8X-XXB-XXX
Matching Mates:

- Cable Pin
3X8X-XPB-XXX
- Cable Socket
3X8X-XSB-XXX



Mechanical Back Shell
(Style #5)



Square Flange Adapter
4296



Square Flange Gasket
4297



Dust Cap
4295



Winged Coupling Ring
W/4482

Molded Cable Assemblies (See pages 3 & 26)



Cable End



Cable to Cable



Right Angle

MULTI-CON-X® FIELD INSTALLABLE CONNECTORS

Dimensions

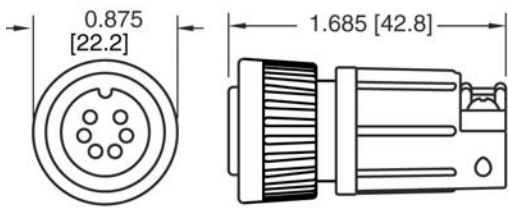

CABLE END CONNECTOR
STYLE 5 LONG
THREADED BACKSHELL

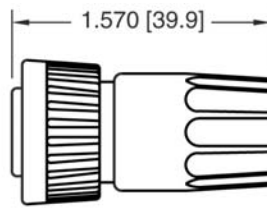

CABLE END CONNECTOR (SOLDER)
STYLE 3 AND 3DC LONG
THREADED BACKSHELL
(SOLDER TYPE CONTACT ONLY)

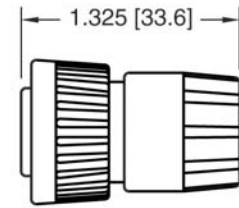

CABLE END CONNECTOR (CRIMP)
STYLE 3 AND 3DC SHORT
THREADED BACKSHELL
(CRIMP TYPE CONTACT ONLY)

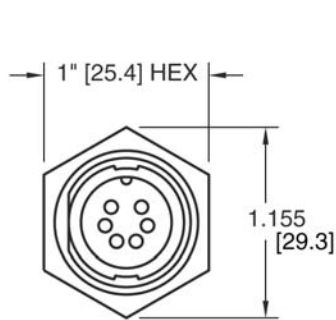

13/16" [20.6]-27 UNS MOD. THREAD
1/32" TO 3/16" PANEL
[0.8 TO 4.8]

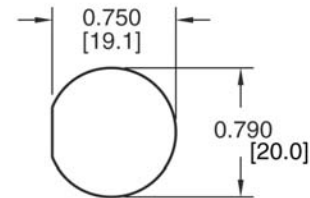
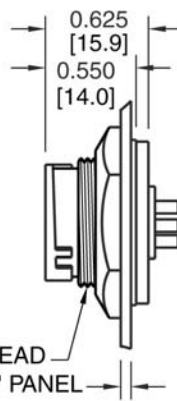

RECOMMENDED
PANEL CUT-OUT
±.003 [±0.1]

PANEL MOUNT CONNECTOR
SHOWN WITH HEX NUT AND GASKET

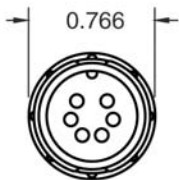

CABLE TO CABLE CONNECTOR
STYLE 5 LONG THREADED BACKSHELL

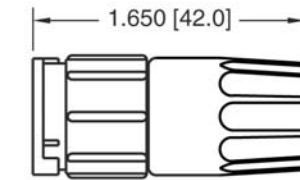
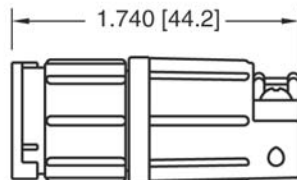

CABLE TO CABLE CONNECTOR
STYLE 3 AND 3DC LONG
THREADED BACKSHELL
(SOLDER TYPE CONTACT ONLY)

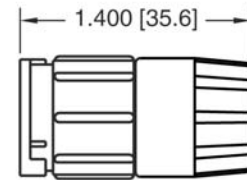

CABLE TO CABLE CONNECTOR
STYLE 3 AND 3DC SHORT
THREADED BACKSHELL
(CRIMP TYPE CONTACT ONLY)

Molded Cable Assemblies (See pages 3 & 26)

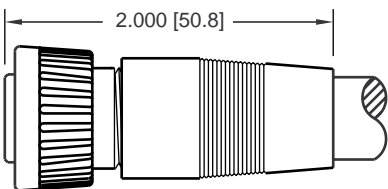

CABLE END ASSEMBLY
STRAIGHT BOOT 0.500 [12.7] MAX. CABLE O.D.

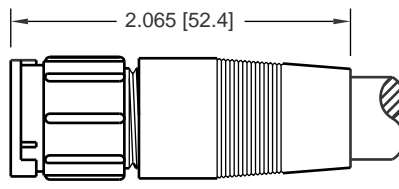

CABLE TO CABLE ASSEMBLY
STRAIGHT BOOT 0.500 [12.7] MAX. CABLE O.D.

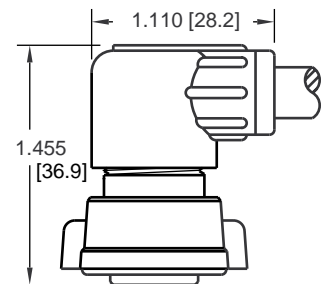

CABLE END ASSEMBLY
90° BOOT 0.365 [9.3] MAX. CABLE O.D.

MULTI-CON-X[®] FIELD INSTALLABLE CONNECTORS

Part Number to Order

X X XX-X XG-XXX

Connector Type: _____

- 3 - Cable End
- 4 - Panel Mount
- 5 - Cable to Cable

Contact Size: _____

- 1 - #12 (2-4 Contacts)
- 2 - #20 (4-9 Contacts)
- 3 - #16 (4-6 Contacts)

Contact Style: _____

- 80 - Crimp (Supplied loose)
- 81 - P/C Tail .187" (4.7) (Supplied assembled)
- 82 - Solder Cup (Supplied assembled)
- 91 - P/C Tail .280" (7.1) (Supplied assembled)*
- 92 - P/C Tail .335" (8.5) (Supplied assembled)*

Number of Contacts: _____

- 2, 3, 4, 5, 6, 7, 8 & 9

Type of Contact: _____

- P - Pin
- S - Socket

Contact Plating: _____

- G - Gold over Nickel (Standard)

EMI/RFI shielded assemblies available - consult factory.

*Available in #20 size contact only.

Consult factory for optional threaded coupling.

Consult factory for your custom design cable assemblies and connectors. (See pages 3 & 26)

Grommet Code -

Cable O.D. Range:

- 15 - .15 - .17 (3.8-4.3)
- 18 - .18 - .20 (4.6-5.1)
- 21 - .21 - .23 (5.3-5.8)
- 24 - .24 - .27 (6.1-6.8)
- 28 - .24 - .28 (7.1-7.4)
- 30 - .30 - .32 (7.6-8.1)

Back Shell
Style
3 or 5

Back Shell Style:

- 3 - Weathertight grommet grip/seal & (1) interfacial "O" ring.
- 3DC - Daisy chain grommet with 3 I.D.s (.125, .188 & .250)
- 5 - Mechanical screw-down cable clamp with grommet seal.
- 300 - Panel mount with hex nut & gasket.
- 3ES - 300 with Epoxy (Panel Mount Only)

Contact Arrangements



Contact arrangements shown are wiring view of cable end pins/sockets.

Key/keyway shown for orientation only.

*Available in connector types: cable end socket, panel mount pin, and cable to cable pin styles only.

MULTI-CON-X[®] FIELD INSTALLABLE CONNECTORS

Specifications

Typical Specifications

Manufacturers Identifications	Multi-Con-X [®]
Description	Field Installable Connector & Custom Cable Assemblies
Rating	1.95 thru 23.0A, 600V
Conductor Size	#12 Contacts, 12 thru 14 AWG #16 Contacts, 16 thru 18 AWG #20 Contacts, 20 thru 24 AWG
Configuration	2 thru 4 #12 Contacts 4 thru 6 #16 Contacts 4 thru 9 #20 Contacts
Certification	UL Recognized File #E138878 - 250V CSA Certified File #LR89277 - 600V

Material Specifications

Cable Pin/Socket

Backshell (Threaded)	Nylon, UL Recognized, Black (Style #3)
Grommet	Santoprene Rubber, Black
Coupling Ring	Nylon, UL Recognized, Black
Contacts	Brass, Gold over Nickel
Connector Body	Nylon, UL Recognized, Black
O-Ring	Nitrile Rubber, Black
Sleeve	Nylon, UL Recognized, Black

Cable to Cable

Backshell (Threaded)	Nylon, UL Recognized, Black (Style #3)
Grommet	Santoprene, Rubber, Black
Contacts	Brass, Gold over Nickel
Connector Body	Nylon, UL Recognized, Black

Optional

Long Backshell (Threaded)	Nylon, UL Recognized, Black (Style #3 with solder contacts)
Winged Coupling Ring	Nylon, UL Recognized, Black (W/4482)
Mechanical Backshell (Threaded)	Nylon, UL Recognized, Black (Style #5)
- Strap	Nylon, UL Recognized, Black
- Screws	Cadmium Plated

Panel Mount

Contacts	Brass, Gold over Nickel
Panel Body	Nylon, UL Recognized, Black
Gasket	Nitrile Rubber, Black
Hex Nut	Nylon, UL Recognized, Black

Optional

Dust Cap	Santoprene Rubber, Black (Part No. 4295)
Square Flange Adapter	Nylon, UL Recognized, Black (Part No. 4296)
Square Flange Adapter Gasket	Nitrile Rubber, Black (Part No. 4297)

Mechanical Specifications

Durability	Minimum 300 mate/unmate cycles without mechanical or electrical failure
Vibration	Coupling rings have overriding locking feature to prevent loosening or separation of connector
Hex Nut Torque	All series hex nut to withstand 10-12 inch/lb tightening torque

Electrical Specifications

Voltage	600 V
Current	See Electrical Current Rating Chart (Page 27)

Environmental Specifications

Temperature Rating	-55°C to +125°C (-67°F to +257°F)
Corrosion	300 Hr salt spray contacts
Weatheright	Consult factory with specific application

Molded Cable Assemblies

Watertight	(See Pages 3 & 26) NEMA 6P, 13: IEC IP67
------------	---



Компания «ЭлектроПласт» предлагает заключение долгосрочных отношений при поставках импортных электронных компонентов на взаимовыгодных условиях!

Наши преимущества:

- Оперативные поставки широкого спектра электронных компонентов отечественного и импортного производства напрямую от производителей и с крупнейших мировых складов;
- Поставка более 17-ти миллионов наименований электронных компонентов;
- Поставка сложных, дефицитных, либо снятых с производства позиций;
- Оперативные сроки поставки под заказ (от 5 рабочих дней);
- Экспресс доставка в любую точку России;
- Техническая поддержка проекта, помощь в подборе аналогов, поставка прототипов;
- Система менеджмента качества сертифицирована по Международному стандарту ISO 9001;
- Лицензия ФСБ на осуществление работ с использованием сведений, составляющих государственную тайну;
- Поставка специализированных компонентов (Xilinx, Altera, Analog Devices, Intersil, Interpoint, Microsemi, Aeroflex, Peregrine, Syfer, Eurofarad, Texas Instrument, Miteq, Cobham, E2V, MA-COM, Hittite, Mini-Circuits, General Dynamics и др.);

Помимо этого, одним из направлений компании «ЭлектроПласт» является направление «Источники питания». Мы предлагаем Вам помощь Конструкторского отдела:

- Подбор оптимального решения, техническое обоснование при выборе компонента;
- Подбор аналогов;
- Консультации по применению компонента;
- Поставка образцов и прототипов;
- Техническая поддержка проекта;
- Защита от снятия компонента с производства.



Как с нами связаться

Телефон: 8 (812) 309 58 32 (многоканальный)

Факс: 8 (812) 320-02-42

Электронная почта: org@eplast1.ru

Адрес: 198099, г. Санкт-Петербург, ул. Калинина, дом 2, корпус 4, литера А.