

# Ratchet Relay G4Q

CSM\_G4Q\_DS\_E\_3\_1

## Unique Ratchet Mechanism Assures Positive Alternate Transfer/Switching Operation

- Each contact in the double-pole contact mechanism performs alternate make-brake operation at each pulse input and is thus ideal for alternate operation or transfer/switching operation of a motor.
- Positive operation is assured due to the unique ratchet mechanism.
- Satisfies dielectric strength of 2,000 VAC.
- Low power consumption.  
(AC: approx. 6.4 VA; DC: approx. 3.9 W)

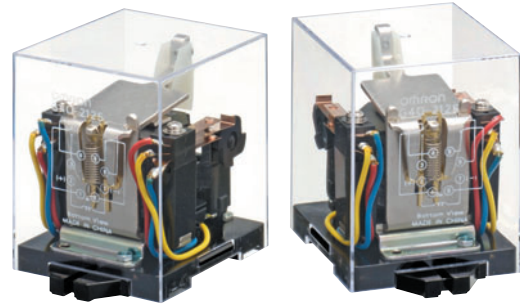

## Ordering Information

### Open Models

| Item        | DPDT     |               |
|-------------|----------|---------------|
|             | Model    | Rated voltage |
| Basic model | G4Q-211A | 24 VAC        |
|             |          | 50 VAC        |
|             |          | 100/(110) VAC |
|             |          | 200/(220) VAC |
|             |          | 12 VDC        |
|             |          | 24 VDC        |
|             |          | 100 VDC       |

### Plug-in Models

| Item        | DPDT     |               |
|-------------|----------|---------------|
|             | Model    | Rated voltage |
| Basic model | G4Q-212S | 12 VAC        |
|             |          | 24 VAC        |
|             |          | 50 VAC        |
|             |          | 100/(110) VAC |
|             |          | 200/(220) VAC |
|             |          | 12 VDC        |
|             |          | 24 VDC        |
|             |          | 100 VDC       |

**Note:** When ordering, add the rated coil voltage (listed in *Specifications*) to the model number.

Example: G4Q-211A, 24 VAC  
Rated coil voltage

### Model Number Legend

G4Q-□□□□  
1 2 3 4

#### 1. Contact Form

2: DPDT

#### 2. Contact Type

1: Single

#### 3. Enclosure Construction

1: No casing

2: Casing

#### 4. Terminal Shape

A: Solder

S: Plug-in

## ■ Accessories (Order Separately)

| DIN track/Front-connecting Socket | Back-connecting Socket |
|-----------------------------------|------------------------|
| Screw terminal                    | Solder terminal        |
| 8PFA1                             | PL08                   |

## Specifications

### ■ Coil Ratings

| Item | Current (mA)      |       | Resistance ( $\Omega$ ) | Must operate | Must release | Max. voltage | Power consumption |                    |                   |
|------|-------------------|-------|-------------------------|--------------|--------------|--------------|-------------------|--------------------|-------------------|
|      | Rated voltage (V) | 50 Hz |                         |              |              |              | 60 Hz             | Initial            | Rated             |
| AC   | 12                | 614   | 531                     | 2.24         | 80 % max.    | 10 % min.    | 110 % max.        | Approx.<br>13.5 VA | Approx.<br>6.4 VA |
|      | 24                | 307   | 266                     |              |              |              |                   |                    |                   |
|      | 50                | 148   | 128                     |              |              |              |                   |                    |                   |
|      | 100/<br>(110)     | 74    | 64/73.5                 |              |              |              |                   |                    |                   |
|      | 200/<br>(220)     | 37    | 32/36.8                 |              |              |              |                   |                    |                   |

| Item | Current (mA)      |       | Resistance ( $\Omega$ ) | Must operate | Must release | Max. voltage | Power consumption |         |
|------|-------------------|-------|-------------------------|--------------|--------------|--------------|-------------------|---------|
|      | Rated voltage (V) | 50 Hz |                         |              |              |              | 60 Hz             | Initial |
| DC   | 12                | 320   |                         | 37.5         | 5 % min.     |              | Approx. 3.9 W     |         |
|      | 24                | 155   |                         |              |              |              |                   |         |
|      | 100               | 39    |                         |              |              |              |                   |         |
|      | 200               | 19.2  |                         |              |              |              |                   |         |

- Note:**
- The rated current and coil resistance are measured at a coil temperature of 23°C with tolerances of +15%/–20% for AC rated current and  $\pm 15\%$  for DC coil resistance.
  - The AC coil resistance values are for reference only.
  - Performance characteristic data is measured at a coil temperature of 23°C.
  - The maximum voltage is one that is applicable instantaneously to the Relay coil at an ambient temperature of 23°C and not continuously.
  - The AC power consumption is measured at 60 Hz.

### ■ Contact Ratings

| Load                   | Resistive load<br>( $\cos\phi = 1$ ) | Inductive load<br>( $\cos\phi = 0.4$ )<br>(L/R = 7 ms) |
|------------------------|--------------------------------------|--|
| Contact mechanism      | Single                               |  |
| Contact material       | Silver alloy                         |  |
| Rated load             | 5 A at 220 VAC, 5 A at 24 VDC        | 3 A at 220 VAC, 4 A at 24 VDC                          |
| Rated carry current    | 5 A                                  |  |
| Max. switching voltage | 250 VAC, 250 VDC                     |  |
| Max. switching current | 5 A                                  |  |

## ■ Characteristics

|  |   |
|--|---|
| <b>Contact resistance (See note 2.)</b>    | 50 mΩ max.  |
| <b>Operate time (See note 3.)</b>          | 60 ms max.  |
| <b>Max. operating frequency</b>            | Mechanical: 1,200 operations/hr<br>Electrical: 1,200 operations/hr (under rated load)   |
| <b>Insulation resistance (See note 4.)</b> | 100 MΩ min. (at 500 VDC)  |
| <b>Dielectric strength</b>                 | 2,000 VAC, 50/60 Hz for 1 min between coil and contact (1,000 VAC, 50/60 Hz for 1 min between contacts of same polarity) (2,000 VAC between contacts of different polarities)                                   |
| <b>Vibration resistance</b>                | Destruction: 10 to 55 to 10 Hz, 0.75 mm single amplitude (1.5 mm double amplitude)<br>Malfunction: 10 to 55 to 10 Hz, 0.5 mm single amplitude (1.0 mm double amplitude)   |
| <b>Shock resistance</b>                    | Destruction: 500 m/s <sup>2</sup><br>Malfunction: 100 m/s <sup>2</sup>  |
| <b>Endurance</b>                           | Mechanical: 5,000,000 operations min. (at operating frequency of 1,200 operations/hr)<br>Electrical: 500,000 operations min. (under rated load and at operating frequency of 1,200 operations/hr) (See note 5.) |
| <b>Error rate (See note 6.)</b>            | 1 A at 5 VDC (0.1 A at 5 VDC)   |
| <b>Ambient temperature</b>                 | Operating: -10°C to 55°C (with no icing or no condensation)   |
| <b>Ambient humidity</b>                    | Operating: 5% to 85%  |
| <b>Weight</b>                              | Open model: Approx. 240 g; cased model: Approx. 340 g   |

**Note:** 1. The data shown above are initial values.

2. The contact resistance was measured with 0.1 A at 5 VDC using the voltage drop method.

3. The operate time was measured with the rated voltage imposed with any contact bounce ignored at an ambient temperature of 23°C.

4. The insulation resistance was measured with a 500-VDC megger applied to the same places as those used for checking the dielectric strength.

5. The electrical endurance was measured at an ambient temperature of 23°C.

6. This value was measured at a switching frequency of 60 operations per minute. The value in parentheses is for the cased model.

## Engineering Data

### Maximum Switching Power

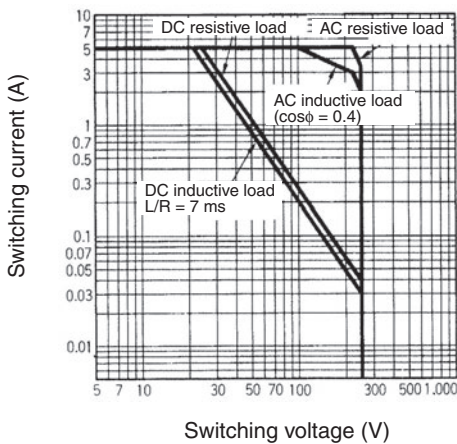

### Electrical Endurance

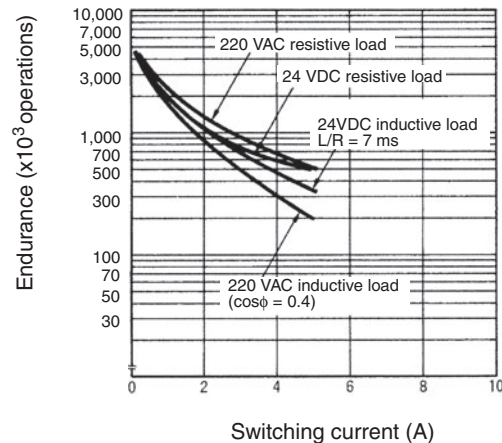

**Ambient Temperature vs. Coil Temperature Rise**  
100 VAC 50 Hz

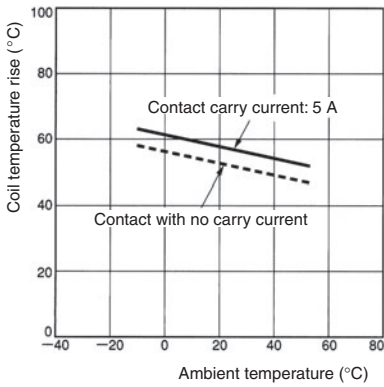

**24 VDC**

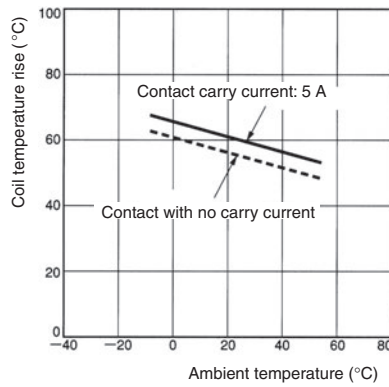

**Malfunctioning Shock**

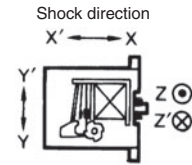
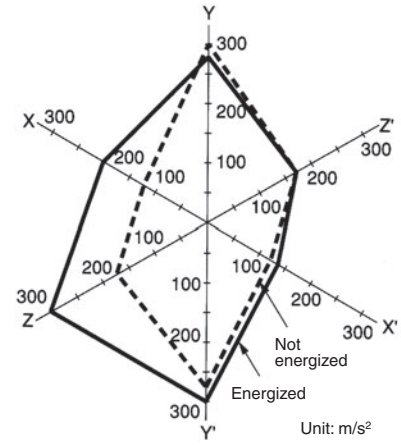

Number of samples: 5  
Measurement conditions:  
Impose a shock of 100 m/s<sup>2</sup> in the ±X, ±Y, and ±Z directions three times each with the Relay energized and not energized to check the shock values that cause the Relay to malfunction.

**Operation**

**Operation Timing Chart**

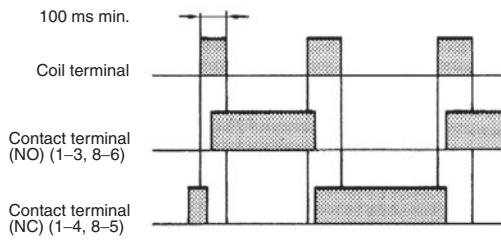

**Note:** When a pulse for application to the coil is used, such a pulse should have a width of 100 ms or more. If a pulse is applied with a width less than the operate time, the cam may fail to rotate fully.

**Dimensions**

**Note:** All units are in millimeters unless otherwise indicated.

**Open Model**  
G4Q-211A

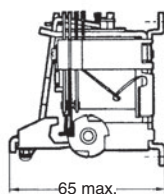
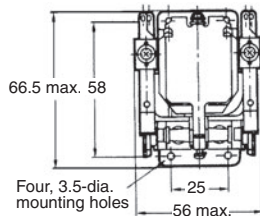
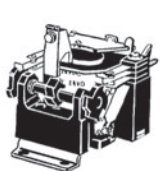

**Terminal Arrangement/ Internal Connections**

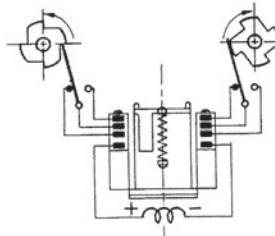

**Mounting Holes**

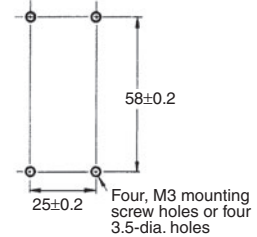

**Plug-in Terminal Model**  
G4Q-212S

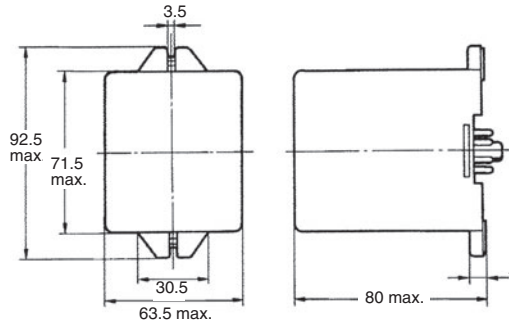
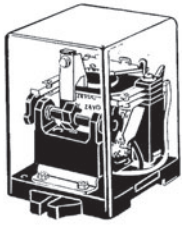

**Terminal Arrangement/  
Internal Connections**  
(Bottom view)

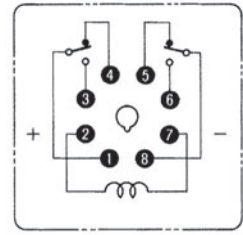

**Relay Mounting Height with Socket**

With Front-connecting  
Socket

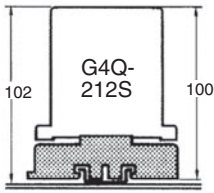

8PFA1

With Back-connecting  
Socket

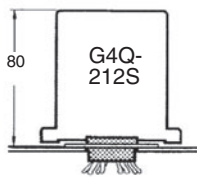

PL08

**Safety Precautions**

Refer to *Safety Precautions for All Relays*.

■ **Surface Mounting Socket**

Be sure to provide a mounting space according to the width of the Relay. The width of the Relay is 63.5 mm and the width of the Socket is 51 mm.

■ **Mounting**

Mount the Relay so that the coil faces upward and the cam faces downwards with the mounting plate secured vertically. Do not change the cam angle.

Make sure that Relay terminals are free of flux or any other foreign substance before soldering the Relay terminals.

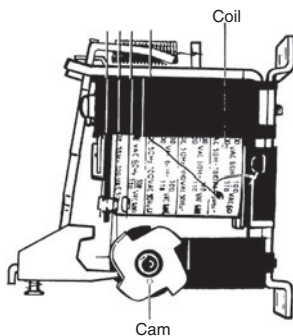

ALL DIMENSIONS SHOWN ARE IN MILLIMETERS.  
To convert millimeters into inches, multiply by 0.03937. To convert grams into ounces, multiply by 0.03527.

In the interest of product improvement, specifications are subject to change without notice.

## Read and Understand This Catalog

Please read and understand this catalog before purchasing the products. Please consult your OMRON representative if you have any questions or comments.

## Warranty and Limitations of Liability

### WARRANTY

OMRON's exclusive warranty is that the products are free from defects in materials and workmanship for a period of one year (or other period if specified) from date of sale by OMRON.

OMRON MAKES NO WARRANTY OR REPRESENTATION, EXPRESS OR IMPLIED, REGARDING NON-INFRINGEMENT, MERCHANTABILITY, OR FITNESS FOR PARTICULAR PURPOSE OF THE PRODUCTS. ANY BUYER OR USER ACKNOWLEDGES THAT THE BUYER OR USER ALONE HAS DETERMINED THAT THE PRODUCTS WILL SUITABLY MEET THE REQUIREMENTS OF THEIR INTENDED USE. OMRON DISCLAIMS ALL OTHER WARRANTIES, EXPRESS OR IMPLIED.

### LIMITATIONS OF LIABILITY

OMRON SHALL NOT BE RESPONSIBLE FOR SPECIAL, INDIRECT, OR CONSEQUENTIAL DAMAGES, LOSS OF PROFITS OR COMMERCIAL LOSS IN ANY WAY CONNECTED WITH THE PRODUCTS, WHETHER SUCH CLAIM IS BASED ON CONTRACT, WARRANTY, NEGLIGENCE, OR STRICT LIABILITY.

In no event shall the responsibility of OMRON for any act exceed the individual price of the product on which liability is asserted.

IN NO EVENT SHALL OMRON BE RESPONSIBLE FOR WARRANTY, REPAIR, OR OTHER CLAIMS REGARDING THE PRODUCTS UNLESS OMRON'S ANALYSIS CONFIRMS THAT THE PRODUCTS WERE PROPERLY HANDLED, STORED, INSTALLED, AND MAINTAINED AND NOT SUBJECT TO CONTAMINATION, ABUSE, MISUSE, OR INAPPROPRIATE MODIFICATION OR REPAIR.

## Application Considerations

### SUITABILITY FOR USE

OMRON shall not be responsible for conformity with any standards, codes, or regulations that apply to the combination of products in the customer's application or use of the products.

At the customer's request, OMRON will provide applicable third party certification documents identifying ratings and limitations of use that apply to the products. This information by itself is not sufficient for a complete determination of the suitability of the products in combination with the end product, machine, system, or other application or use.

The following are some examples of applications for which particular attention must be given. This is not intended to be an exhaustive list of all possible uses of the products, nor is it intended to imply that the uses listed may be suitable for the products:

- Outdoor use, uses involving potential chemical contamination or electrical interference, or conditions or uses not described in this catalog.
- Nuclear energy control systems, combustion systems, railroad systems, aviation systems, medical equipment, amusement machines, vehicles, safety equipment, and installations subject to separate industry or government regulations.
- Systems, machines, and equipment that could present a risk to life or property.

Please know and observe all prohibitions of use applicable to the products.

NEVER USE THE PRODUCTS FOR AN APPLICATION INVOLVING SERIOUS RISK TO LIFE OR PROPERTY WITHOUT ENSURING THAT THE SYSTEM AS A WHOLE HAS BEEN DESIGNED TO ADDRESS THE RISKS, AND THAT THE OMRON PRODUCTS ARE PROPERLY RATED AND INSTALLED FOR THE INTENDED USE WITHIN THE OVERALL EQUIPMENT OR SYSTEM.

### PROGRAMMABLE PRODUCTS

OMRON shall not be responsible for the user's programming of a programmable product, or any consequence thereof.

## Disclaimers

### CHANGE IN SPECIFICATIONS

Product specifications and accessories may be changed at any time based on improvements and other reasons.

It is our practice to change model numbers when published ratings or features are changed, or when significant construction changes are made. However, some specifications of the products may be changed without any notice. When in doubt, special model numbers may be assigned to fix or establish key specifications for your application on your request. Please consult with your OMRON representative at any time to confirm actual specifications of purchased products.

### DIMENSIONS AND WEIGHTS

Dimensions and weights are nominal and are not to be used for manufacturing purposes, even when tolerances are shown.

### PERFORMANCE DATA

Performance data given in this catalog is provided as a guide for the user in determining suitability and does not constitute a warranty. It may represent the result of OMRON's test conditions, and the users must correlate it to actual application requirements. Actual performance is subject to the OMRON Warranty and Limitations of Liability.

### ERRORS AND OMISSIONS

The information in this document has been carefully checked and is believed to be accurate; however, no responsibility is assumed for clerical, typographical, or proofreading errors, or omissions.

2010.8

In the interest of product improvement, specifications are subject to change without notice.

**OMRON Corporation**  
Industrial Automation Company

<http://www.ia.omron.com/>

(c)Copyright OMRON Corporation 2010 All Right Reserved.



Компания «ЭлектроПласт» предлагает заключение долгосрочных отношений при поставках импортных электронных компонентов на взаимовыгодных условиях!

Наши преимущества:

- Оперативные поставки широкого спектра электронных компонентов отечественного и импортного производства напрямую от производителей и с крупнейших мировых складов;
- Поставка более 17-ти миллионов наименований электронных компонентов;
- Поставка сложных, дефицитных, либо снятых с производства позиций;
- Оперативные сроки поставки под заказ (от 5 рабочих дней);
- Экспресс доставка в любую точку России;
- Техническая поддержка проекта, помощь в подборе аналогов, поставка прототипов;
- Система менеджмента качества сертифицирована по Международному стандарту ISO 9001;
- Лицензия ФСБ на осуществление работ с использованием сведений, составляющих государственную тайну;
- Поставка специализированных компонентов (Xilinx, Altera, Analog Devices, Intersil, Interpoint, Microsemi, Aeroflex, Peregrine, Syfer, Eurofarad, Texas Instrument, Miteq, Cobham, E2V, MA-COM, Hittite, Mini-Circuits, General Dynamics и др.);

Помимо этого, одним из направлений компании «ЭлектроПласт» является направление «Источники питания». Мы предлагаем Вам помощь Конструкторского отдела:

- Подбор оптимального решения, техническое обоснование при выборе компонента;
- Подбор аналогов;
- Консультации по применению компонента;
- Поставка образцов и прототипов;
- Техническая поддержка проекта;
- Защита от снятия компонента с производства.



#### Как с нами связаться

**Телефон:** 8 (812) 309 58 32 (многоканальный)

**Факс:** 8 (812) 320-02-42

**Электронная почта:** [org@eplast1.ru](mailto:org@eplast1.ru)

**Адрес:** 198099, г. Санкт-Петербург, ул. Калинина, дом 2, корпус 4, литера А.