

## DPDT Basic Switch for Two Independent Circuit Control



- Ideal for switching the circuits operating on two different voltages, and for controlling two independent circuits.
- Interchangeable with OMRON Z Basic Switches, as both switches are identical in mounting hole dimensions, mounting pitch and pin plunger position.



Be sure to read *Safety Precautions* on page 4 and *Safety Precautions for All Basic Switches*.

## Model Number Structure

### Model Number Legend

**DZ-10G**□-**1**□  
(1) (2)(3) (4)(5)

#### (1) Ratings

10 : 10 A (250 VAC)

#### (2) Contact Gap

G : 0.5 mm

#### (3) Actuator

None : Pin plunger  
 V : Hinge lever  
 V22 : Short hinge roller lever  
 V2 : Hinge roller lever  
 W : Hinge lever  
 W22 : Short hinge roller lever  
 W2 : Hinge roller lever

#### (4) Contact Form

1 : DPDT

#### (5) Terminals

A : Solder terminal  
 B : Screw terminal

## Ordering Information

| Actuator                 | Terminal | Solder terminal (-1A) |  | Screw terminal (-B) |  |
|--------------------------|----------|-----------------------|--|---------------------|--|
|                          |          | Model                 |  | Model               |  |
| Pin plunger              |          | DZ-10G-1A             |  | DZ-10G-1B           |  |
| Hinge lever              | High OT  | DZ-10GW-1A            |  | DZ-10GW-1B          |  |
|                          | Low OT   | DZ-10GV-1A            |  | DZ-10GV-1B          |  |
| Short hinge roller lever | High OT  | DZ-10GW22-1A          |  | DZ-10GW22-1B        |  |
|                          | Low OT   | DZ-10GV22-1A          |  | DZ-10GV22-1B        |  |
| Hinge roller lever       | High OT  | DZ-10GW2-1A           |  | DZ-10GW2-1B         |  |
|                          | Low OT   | DZ-10GV2-1A           |  | DZ-10GV2-1B         |  |

## Specifications

### Ratings

| Rated voltage | Non-inductive load (A) |    |           |     | Inductive load (A) |    |            |     |
|---------------|------------------------|----|-----------|-----|--------------------|----|------------|-----|
|               | Resistive load         |    | Lamp load |     | Inductive load     |    | Motor load |     |
|               | NC                     | NO | NC        | NO  | NC                 | NO | NC         | NO  |
| 125 VAC       | 10                     |    | 2         | 1   | 6                  |    | 3          | 1.5 |
| 250 VAC       | 10                     |    | 1.5       | 0.7 | 4                  |    | 2          | 1   |
| 8 VDC         | 10                     |    | 3         | 1.5 | 6                  |    | 5          | 2.5 |
| 14 VDC        | 10                     |    | 3         | 1.5 | 6                  |    | 5          | 2.5 |
| 30 VDC        | 10                     |    | 3         | 1.5 | 4                  |    | 3          | 1.5 |
| 125 VAC       | 0.5                    |    | 0.5       |     | 0.05               |    | 0.05       |     |
| 250 VDC       | 0.25                   |    | 0.25      |     | 0.03               |    | 0.03       |     |

### Certified Standard Ratings

Ask your OMRON representative for information on certified models.

#### UL/CSA

| Rated voltage | DZ-10G      |
|---------------|-------------|
| 125 VAC       | 10 A 1/8 HP |
| 250 VAC       | 10 A 1/4 HP |
| 480 VAC       | 2 A         |
| 125 VDC       | 0.5 A       |
| 250 VDC       | 0.25 A      |

Note: 1. The above values are for steady-state current.

2. Inductive load has a power factor of 0.4 min. (AC) and a time constant of 7 ms max. (DC).

3. Lamp load has an inrush current of 10 times the steady-state current.

4. Motor load has an inrush current of 6 times the steady-state current.

5. The ratings values apply under the following test conditions:

(1) Ambient temperature: 20±2°C

(2) Ambient humidity: 65±5%RH

(3) Operating frequency: 20 operations/min

**Accessories (Terminal Covers, Actuators, and Separators): Refer to Z/A/X/DZ Common Accessories and Z/X/DZ Common Accessories.**

## Characteristics

|  |                    |   |
|--|--------------------|---|
| <b>Operating speed</b>                             |                    | 0.1 mm to 1 m/s *1  |
| <b>Operating frequency</b>                         | <b>Mechanical</b>  | 240 operations/min  |
|  | <b>Electrical</b>  | 20 operations/min   |
| <b>Insulation resistance</b>                       |                    | 100 MΩ min. (at 500 VDC)  |
| <b>Contact resistance</b>                          |                    | 15 mΩ max. (initial value)  |
| <b>Dielectric strength</b>                         |                    | 1,000 VAC, 50/60 Hz for 1 min between non-continuous terminals<br>1,500 VAC, 50/60 Hz for 1 min between current-carrying metal parts and non-current-carrying metal part, and between current-carrying metal part and ground and between switches |
| <b>Vibration resistance</b>                        | <b>Malfunction</b> | 10 to 55 Hz, 1.5-mm double amplitude *2   |
| <b>Shock resistance</b>                            | <b>Destruction</b> | 1,000 m/s <sup>2</sup> max.   |
|  | <b>Malfunction</b> | 300 m/s <sup>2</sup> max. *1 *2   |
| <b>Durability</b>                                  | <b>Mechanical</b>  | 1,000,000 operations min.   |
|  | <b>Electrical</b>  | 500,000 operations min.   |
| <b>Degree of protection</b>                        |                    | IP00  |
| <b>Degree of protection against electric shock</b> |                    | Class I   |
| <b>Proof tracking index (PTI)</b>                  |                    | 175   |
| <b>Ambient operating temperature</b>               |                    | -25°C to 80°C (with no icing)   |
| <b>Ambient operating humidity</b>                  |                    | 35% to 85%RH  |
| <b>Weight</b>                                      |                    | Approx. 30 to 50 g  |

\*1. The values are for pin plunger models. (Contact your OMRON representative for other models.)

\*2. Malfunction: 1 ms max.

## Contact Specifications

|                       |                             |              |
|-----------------------|-----------------------------|--------------|
| <b>Contacts</b>       | <b>Material</b>             | Silver alloy |
|                       | <b>Gap (standard value)</b> | 0.5 mm       |
| <b>Inrush current</b> | <b>NC</b>                   | 30 A max.    |
|                       | <b>NO</b>                   | 15 A max.    |

## Structure

### Contact Form (DPDT)

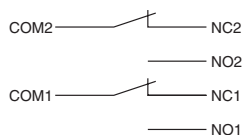

## Dimensions

(Unit: mm)

### Terminals

#### Solder Terminals (-1A)

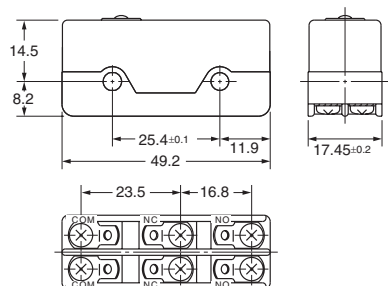

#### Screw Terminals (-1B)

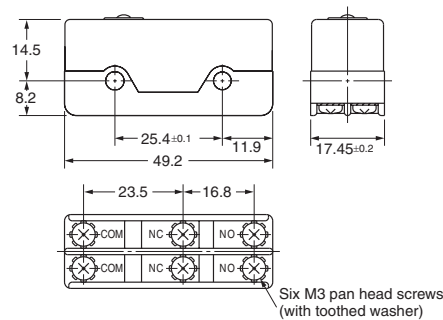

## Dimensions and Operating Characteristics

The solder terminal model has a suffix "-1A" in its model number and its omitted dimensions are the same as the corresponding dimensions of the pin plunger model.

### Pin Plunger

#### DZ-10G-1B

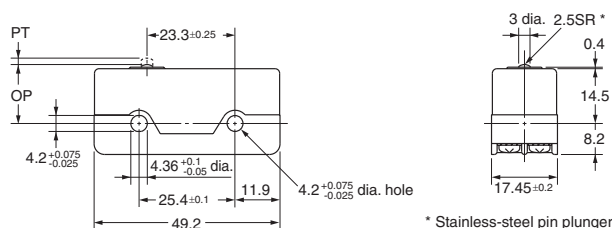

\* Stainless-steel pin plunger

## Engineering Data

### Mechanical Durability (DZ-10G-1B)

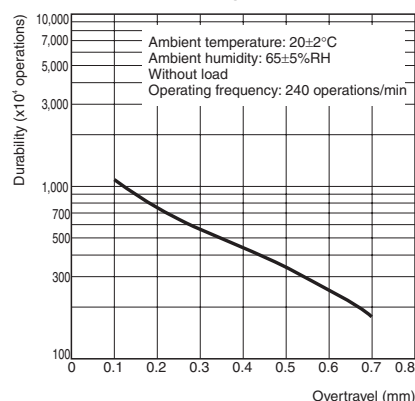

### Electrical Durability (DZ-10G-1B)

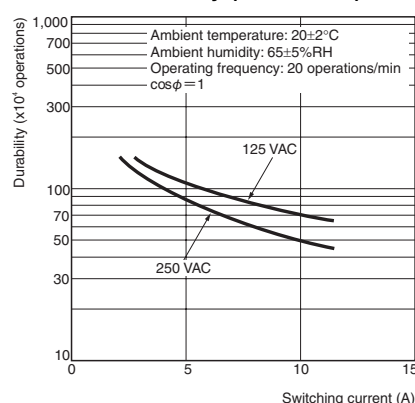

**Hinge Lever**  
**DZ-10GW-1B**

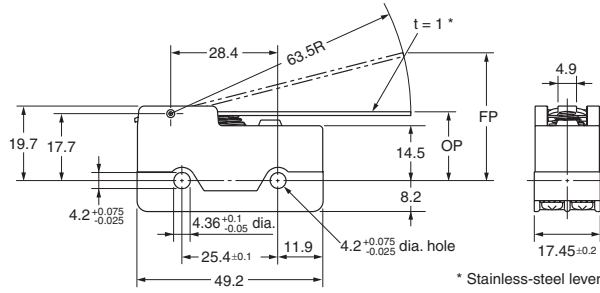

|           |             |           |
|-----------|-------------|-----------|
| <b>OF</b> | <b>max.</b> | 1.67 N    |
| <b>RF</b> | <b>min.</b> | 0.27 N    |
| <b>OT</b> | <b>max.</b> | 1.6 mm    |
| <b>MD</b> | <b>min.</b> | 4 mm      |
| <b>FP</b> | <b>max.</b> | 46.3 mm   |
| <b>OP</b> |             | 21.8±1 mm |

**DZ-10GV-1B**

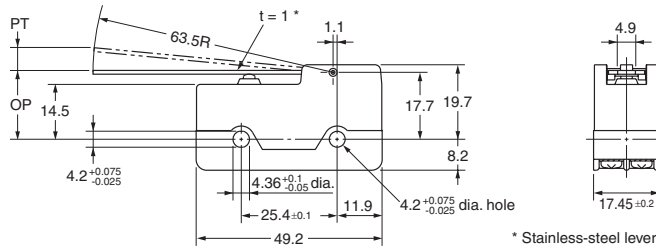
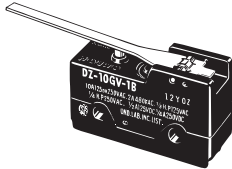

|           |             |           |
|-----------|-------------|-----------|
| <b>OF</b> | <b>max.</b> | 1.96 N    |
| <b>RF</b> | <b>min.</b> | 0.13 N    |
| <b>PT</b> | <b>max.</b> | 6 mm      |
| <b>OT</b> | <b>min.</b> | 0.4 mm    |
| <b>MD</b> | <b>max.</b> | 1.7 mm    |
| <b>OP</b> |             | 18.3±1 mm |

**Short Hinge Roller Lever**  
**DZ-10GW22-1B**

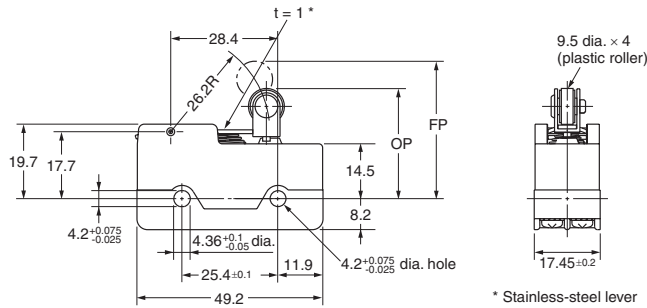

|           |             |             |
|-----------|-------------|-------------|
| <b>OF</b> | <b>max.</b> | 3.92 N      |
| <b>RF</b> | <b>min.</b> | 0.83 N      |
| <b>OT</b> | <b>max.</b> | 0.9 mm      |
| <b>MD</b> | <b>min.</b> | 2.4 mm      |
| <b>FP</b> | <b>max.</b> | 39.7 mm     |
| <b>OP</b> |             | 30.2±0.8 mm |

**DZ-10GV22-1B**

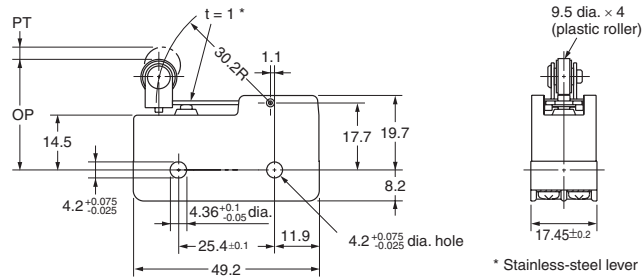

|           |             |             |
|-----------|-------------|-------------|
| <b>OF</b> | <b>max.</b> | 4.22 N      |
| <b>RF</b> | <b>min.</b> | 0.41 N      |
| <b>PT</b> | <b>max.</b> | 3 mm        |
| <b>OT</b> | <b>min.</b> | 0.13 mm     |
| <b>MD</b> | <b>max.</b> | 0.6 mm      |
| <b>OP</b> |             | 29.4±0.8 mm |

**Hinge Roller Lever**  
**DZ-10GW2-1B**

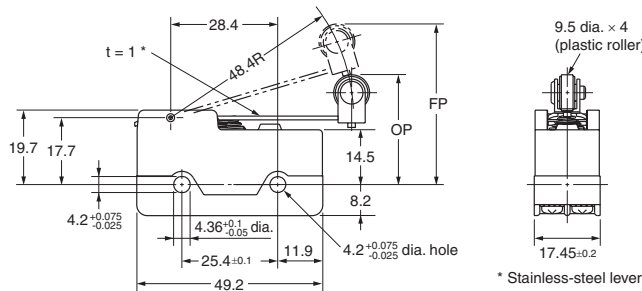
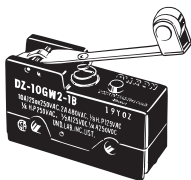

|           |             |             |
|-----------|-------------|-------------|
| <b>OF</b> | <b>max.</b> | 2.09 N      |
| <b>RF</b> | <b>min.</b> | 0.41 N      |
| <b>OT</b> | <b>max.</b> | 1.2 mm      |
| <b>MD</b> | <b>min.</b> | 3.3 mm      |
| <b>FP</b> | <b>max.</b> | 47.6 mm     |
| <b>OP</b> |             | 31.8±0.8 mm |

**DZ-10GV2-1B**

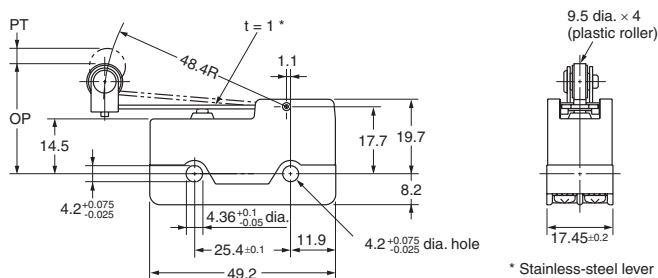
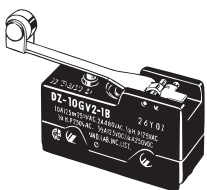

|           |             |             |
|-----------|-------------|-------------|
| <b>OF</b> | <b>max.</b> | 2.65 N      |
| <b>RF</b> | <b>min.</b> | 0.33 N      |
| <b>PT</b> | <b>max.</b> | 4 mm        |
| <b>OT</b> | <b>min.</b> | 0.26 mm     |
| <b>MD</b> | <b>max.</b> | 1.1 mm      |
| <b>OP</b> |             | 29.4±0.8 mm |

Note: Unless otherwise specified, a tolerance of ±0.4 mm applies to all dimensions.

## Safety Precautions

Refer to *Safety Precautions for All Basic Switches*.

### Precautions for Safe Use

#### Terminal Connection

When soldering lead wires to the Switch, make sure that the capacity of the soldering iron is 60 W maximum. Do not take more than 5 s to solder any part of the Switch. The characteristics of the Switch will deteriorate if a soldering iron with a capacity of more than 60 W is applied to any part of the Switch for 5 s or more.

#### Operation

- Make sure that the switching frequency or speed is within the specified range.
  1. If the switching speed is extremely slow, the contact may not be switched smoothly, which may result in a contact failure or contact welding.
  2. If the switching speed is extremely fast, switching shock may damage the Switch soon. If the switching frequency is too high, the contact may not catch up with the speed.

The rated permissible switching speed and frequency indicate the switching reliability of the Switch.  
The life of a Switch is determined at the specified switching speed. The life varies with the switching speed and frequency even when they are within the permissible ranges. In order to determine the life of a Switch model to be applied to a particular use, it is best to conduct an appropriate durability test on some samples of the model under actual conditions.
- Make sure that the actuator travel does not exceed the permissible OT position. The operating stroke must be set to 70% to 100% of the rated OT.

- Do not use the switch in locations subject to hot water (greater than 60°C) or in water vapor.
- Do not use the switch outside the specified temperature and atmospheric conditions.  
The permissible ambient temperature depends on the model. (Refer to the specifications in this catalog.) Sudden thermal changes may cause thermal shock to distort the switch and result in faults.

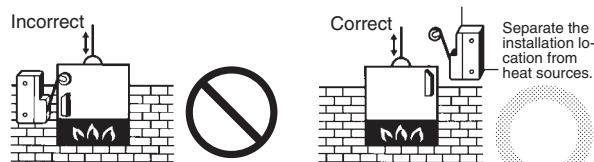

- Mount a cover if the switch is to be installed in a location where worker inattention could result in incorrect operation or accidents.



- Subjecting the switch to continuous vibration or shock may result in contact failure or faulty operation due to abrasion powder and in reduced durability. Excessive vibration or shock will cause the contacts to operate malfunction or become damaged. Mount the switch in a location that is not subject to vibration or shock and in a direction that does not subject the switch to resonance.
- If silver contacts are used with relatively low frequency for a long time or are used with microloads, the sulfide coating produced on the contact surface will not be broken down and contact faults will result. Use a microload switch that uses gold contacts.
- Do not use the switch in atmospheres with high humidity or heat or in harmful gases, such as sulfide gas (H<sub>2</sub>S, SO<sub>2</sub>), ammonia gas (NH<sub>3</sub>), nitric acid gas (HNO<sub>3</sub>), or chlorine gas (Cl<sub>2</sub>). Doing so may impair functionality, such as with damage due to contacting faults or corrosion.
- The switch includes contacts. If the switch is used in an atmosphere with silicon gas, arc energy may cause silicon oxide (SiO<sub>2</sub>) to accumulate on the contacts and result in contact failure. If there is silicon oil, silicon filling, silicon wiring, or other silicon products in the vicinity of the switch, use a contact protection circuit to limit arcing and remove the source of the silicon gas.

### Precautions for Correct Use

#### Mounting Location

- Do not use the switch alone in atmospheres such as flammable or explosive gases. Arcing and heat generation associated with switching may cause fires or explosions.
- Switches are generally not constructed with resistance against water. Use a protective cover to prevent direct spraying if the switch is used in locations subject to splashing or spurting oil or water, dust adhering.

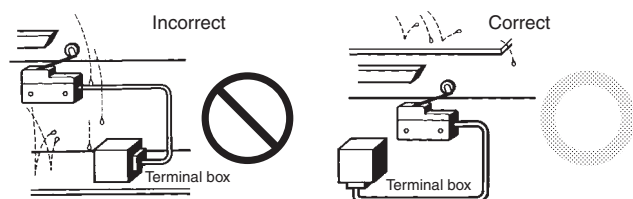

- Install the switch in a location that is not directly subject to debris and dust from cutting. The actuator and the switch body must be protected from accumulated cutting debris and dirt.



#### Mounting

Use M4 mounting screws with plane washers or spring washers to securely mount the Switch. Tighten the screws to a torque of 1.18 to 1.47 N·m.

#### Mounting Holes

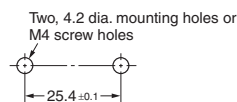

## Accessories (Order separately)

Refer to *Z/A/X/DZ Common Accessories* for details about Terminal Covers, Separators, and Actuators.

## Read and Understand This Catalog

Please read and understand this catalog before purchasing the products. Please consult your OMRON representative if you have any questions or comments.

## Warranty and Limitations of Liability

### WARRANTY

OMRON's exclusive warranty is that the products are free from defects in materials and workmanship for a period of one year (or other period if specified) from date of sale by OMRON.

OMRON MAKES NO WARRANTY OR REPRESENTATION, EXPRESS OR IMPLIED, REGARDING NON-INFRINGEMENT, MERCHANTABILITY, OR FITNESS FOR PARTICULAR PURPOSE OF THE PRODUCTS. ANY BUYER OR USER ACKNOWLEDGES THAT THE BUYER OR USER ALONE HAS DETERMINED THAT THE PRODUCTS WILL SUITABLY MEET THE REQUIREMENTS OF THEIR INTENDED USE. OMRON DISCLAIMS ALL OTHER WARRANTIES, EXPRESS OR IMPLIED.

### LIMITATIONS OF LIABILITY

OMRON SHALL NOT BE RESPONSIBLE FOR SPECIAL, INDIRECT, OR CONSEQUENTIAL DAMAGES, LOSS OF PROFITS OR COMMERCIAL LOSS IN ANY WAY CONNECTED WITH THE PRODUCTS, WHETHER SUCH CLAIM IS BASED ON CONTRACT, WARRANTY, NEGLIGENCE, OR STRICT LIABILITY.

In no event shall the responsibility of OMRON for any act exceed the individual price of the product on which liability is asserted.

IN NO EVENT SHALL OMRON BE RESPONSIBLE FOR WARRANTY, REPAIR, OR OTHER CLAIMS REGARDING THE PRODUCTS UNLESS OMRON'S ANALYSIS CONFIRMS THAT THE PRODUCTS WERE PROPERLY HANDLED, STORED, INSTALLED, AND MAINTAINED AND NOT SUBJECT TO CONTAMINATION, ABUSE, MISUSE, OR INAPPROPRIATE MODIFICATION OR REPAIR.

## Application Considerations

### SUITABILITY FOR USE

OMRON shall not be responsible for conformity with any standards, codes, or regulations that apply to the combination of products in the customer's application or use of the products.

At the customer's request, OMRON will provide applicable third party certification documents identifying ratings and limitations of use that apply to the products. This information by itself is not sufficient for a complete determination of the suitability of the products in combination with the end product, machine, system, or other application or use.

The following are some examples of applications for which particular attention must be given. This is not intended to be an exhaustive list of all possible uses of the products, nor is it intended to imply that the uses listed may be suitable for the products:

- Outdoor use, uses involving potential chemical contamination or electrical interference, or conditions or uses not described in this catalog.
- Nuclear energy control systems, combustion systems, railroad systems, aviation systems, medical equipment, amusement machines, vehicles, safety equipment, and installations subject to separate industry or government regulations.
- Systems, machines, and equipment that could present a risk to life or property.

Please know and observe all prohibitions of use applicable to the products.

NEVER USE THE PRODUCTS FOR AN APPLICATION INVOLVING SERIOUS RISK TO LIFE OR PROPERTY WITHOUT ENSURING THAT THE SYSTEM AS A WHOLE HAS BEEN DESIGNED TO ADDRESS THE RISKS, AND THAT THE OMRON PRODUCTS ARE PROPERLY RATED AND INSTALLED FOR THE INTENDED USE WITHIN THE OVERALL EQUIPMENT OR SYSTEM.

### PROGRAMMABLE PRODUCTS

OMRON shall not be responsible for the user's programming of a programmable product, or any consequence thereof.

## Disclaimers

### CHANGE IN SPECIFICATIONS

Product specifications and accessories may be changed at any time based on improvements and other reasons.

It is our practice to change model numbers when published ratings or features are changed, or when significant construction changes are made. However, some specifications of the products may be changed without any notice. When in doubt, special model numbers may be assigned to fix or establish key specifications for your application on your request. Please consult with your OMRON representative at any time to confirm actual specifications of purchased products.

### DIMENSIONS AND WEIGHTS

Dimensions and weights are nominal and are not to be used for manufacturing purposes, even when tolerances are shown.

### PERFORMANCE DATA

Performance data given in this catalog is provided as a guide for the user in determining suitability and does not constitute a warranty. It may represent the result of OMRON's test conditions, and the users must correlate it to actual application requirements. Actual performance is subject to the OMRON Warranty and Limitations of Liability.

### ERRORS AND OMISSIONS

The information in this document has been carefully checked and is believed to be accurate; however, no responsibility is assumed for clerical, typographical, or proofreading errors, or omissions.

2008.11

In the interest of product improvement, specifications are subject to change without notice.

**OMRON Corporation**  
Industrial Automation Company

<http://www.ia.omron.com/>

(c)Copyright OMRON Corporation 2008 All Right Reserved.

# Mouser Electronics

Authorized Distributor

Click to View Pricing, Inventory, Delivery & Lifecycle Information:

Omron:

[DZ-10GW21-1B](#) [DZE-N-2G](#)



Компания «ЭлектроПласт» предлагает заключение долгосрочных отношений при поставках импортных электронных компонентов на взаимовыгодных условиях!

Наши преимущества:

- Оперативные поставки широкого спектра электронных компонентов отечественного и импортного производства напрямую от производителей и с крупнейших мировых складов;
- Поставка более 17-ти миллионов наименований электронных компонентов;
- Поставка сложных, дефицитных, либо снятых с производства позиций;
- Оперативные сроки поставки под заказ (от 5 рабочих дней);
- Экспресс доставка в любую точку России;
- Техническая поддержка проекта, помощь в подборе аналогов, поставка прототипов;
- Система менеджмента качества сертифицирована по Международному стандарту ISO 9001;
- Лицензия ФСБ на осуществление работ с использованием сведений, составляющих государственную тайну;
- Поставка специализированных компонентов (Xilinx, Altera, Analog Devices, Intersil, Interpoint, Microsemi, Aeroflex, Peregrine, Syfer, Eurofarad, Texas Instrument, Miteq, Cobham, E2V, MA-COM, Hittite, Mini-Circuits, General Dynamics и др.);

Помимо этого, одним из направлений компании «ЭлектроПласт» является направление «Источники питания». Мы предлагаем Вам помощь Конструкторского отдела:

- Подбор оптимального решения, техническое обоснование при выборе компонента;
- Подбор аналогов;
- Консультации по применению компонента;
- Поставка образцов и прототипов;
- Техническая поддержка проекта;
- Защита от снятия компонента с производства.



#### Как с нами связаться

**Телефон:** 8 (812) 309 58 32 (многоканальный)

**Факс:** 8 (812) 320-02-42

**Электронная почта:** [org@eplast1.ru](mailto:org@eplast1.ru)

**Адрес:** 198099, г. Санкт-Петербург, ул. Калинина, дом 2, корпус 4, литера А.