



OT406

Four-quadrant triac, enhanced noise immunity

Rev. 01 — 19 May 2008

Product data sheet

1. Product profile

1.1 General description

Passivated sensitive gate triac in a SOT223 surface-mountable plastic package

1.2 Features

- Sensitive gate
- Direct interfacing to logic level ICs
- Enhanced immunity to voltage transients and noise
- Gate triggering in four quadrants
- Direct interfacing to low power gate drive circuits
- Blocking voltage to 600 V

1.3 Applications

- Home appliances
- Low power AC fan speed controllers
- Low power motor control
- Low power loads in industrial process control

1.4 Quick reference data

- $V_{DRM} \leq 600$ V
- $I_{TSM} \leq 12.5$ A ($t = 20$ ms)
- $I_{T(RMS)} \leq 1$ A
- $I_{GT} \leq 3$ mA
- $I_{GT} \leq 5$ mA (T2– G+)

2. Pinning information

Table 1. Pinning

Pin	Description	Simplified outline	Graphic symbol
1	main terminal 1 (T1)	<p>SOT223</p>	<p>sym051</p>
2	main terminal 2 (T2)		
3	gate (G)		
4	mounting base; main terminal 2 (T2)		

3. Ordering information

Table 2. Ordering information

Type number	Package		Version
	Name	Description	
OT406	SC-73	plastic surface-mounted package with increased heatsink; 4 leads	SOT223

4. Limiting values

Table 3. Limiting values

In accordance with the Absolute Maximum Rating System (IEC 60134).

Symbol	Parameter	Conditions	Min	Max	Unit
V_{DRM}	repetitive peak off-state voltage		-	600	V
V_{RRM}	repetitive peak reverse voltage		-	600	V
$I_{\text{T(RMS)}}$	RMS on-state current	full sine wave; $T_{\text{sp}} \leq 103\text{ °C}$; see Figure 4 and 5	-	1	A
I_{TSM}	non-repetitive peak on-state current	full sine wave; $T_{\text{j}} = 25\text{ °C}$ prior to surge; see Figure 2 and 3			
		$t = 20\text{ ms}$	-	12.5	A
		$t = 16.7\text{ ms}$	-	13.8	A
I^2t	I^2t for fusing	$t_{\text{p}} = 10\text{ ms}$	-	1.28	A^2s
di_{T}/dt	rate of rise of on-state current	$I_{\text{TM}} = 1\text{ A}$; $I_{\text{G}} = 20\text{ mA}$; $di_{\text{G}}/dt = 0.2\text{ A}/\mu\text{s}$			
		T2+ G+	-	50	$\text{A}/\mu\text{s}$
		T2+ G-	-	50	$\text{A}/\mu\text{s}$
		T2- G-	-	50	$\text{A}/\mu\text{s}$
		T2- G+	-	10	$\text{A}/\mu\text{s}$
I_{GM}	peak gate current		-	1	A
P_{GM}	peak gate power		-	2	W
$P_{\text{G(AV)}}$	average gate power	over any 20 ms period	-	0.1	W
T_{stg}	storage temperature		-40	+150	$^{\circ}\text{C}$
T_{j}	junction temperature		-	125	$^{\circ}\text{C}$

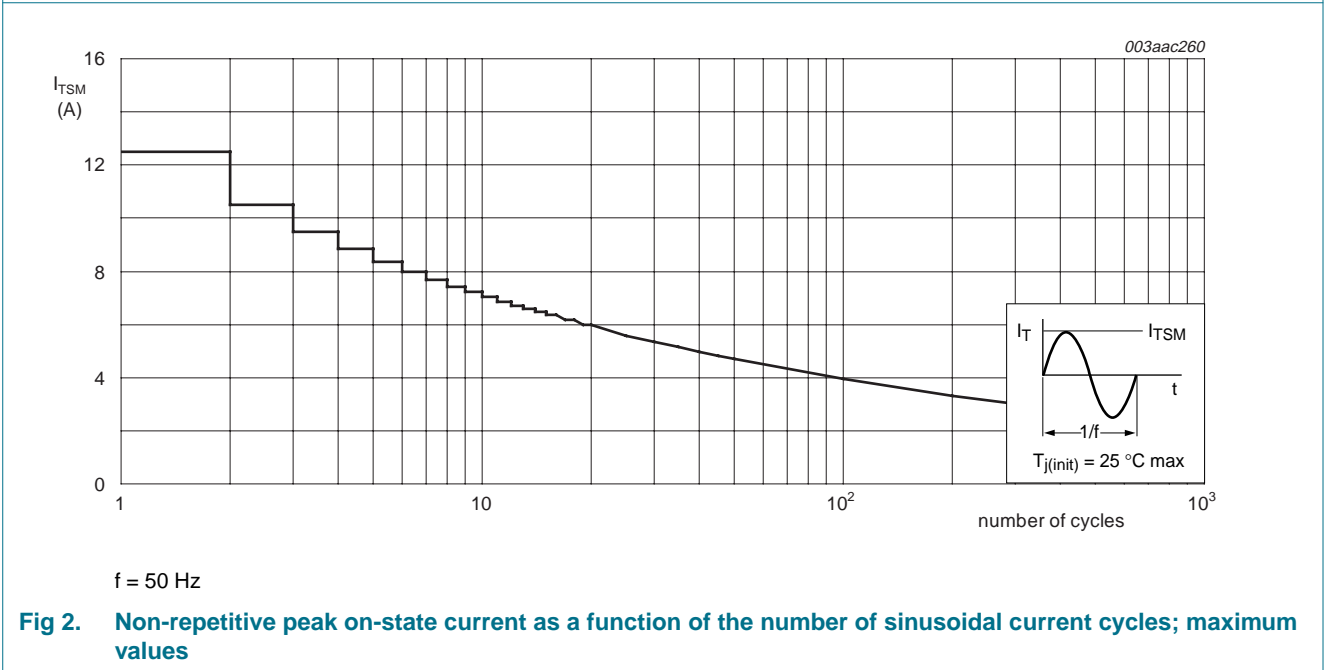
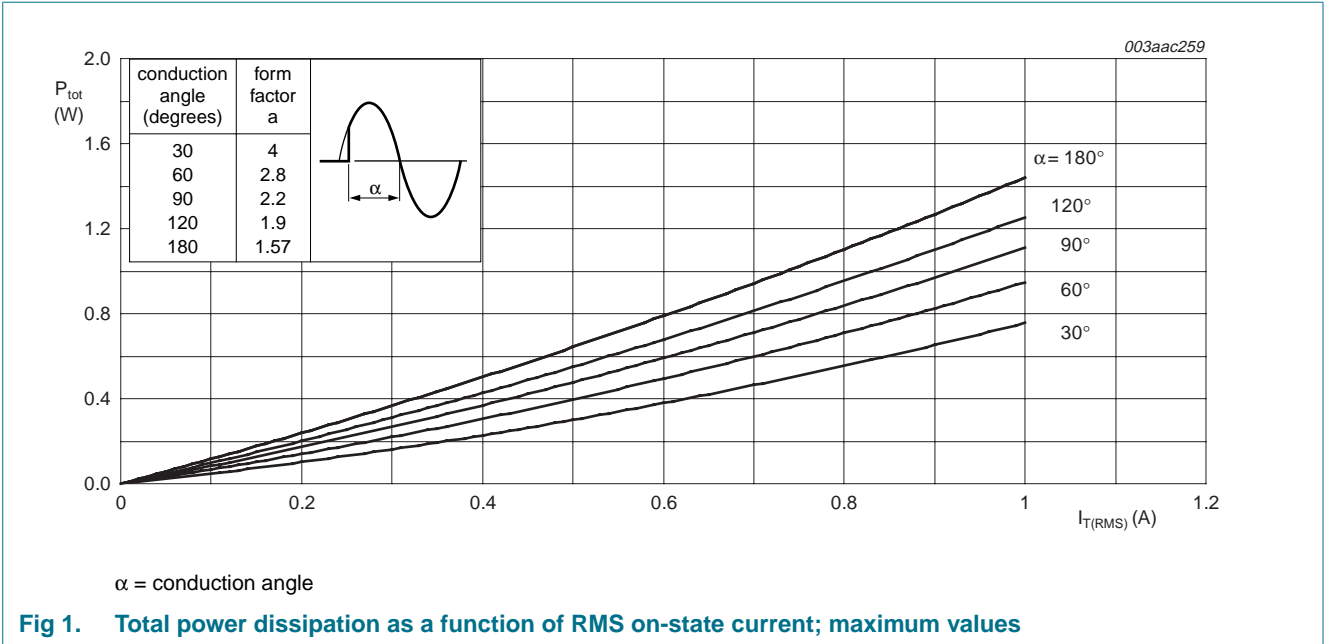

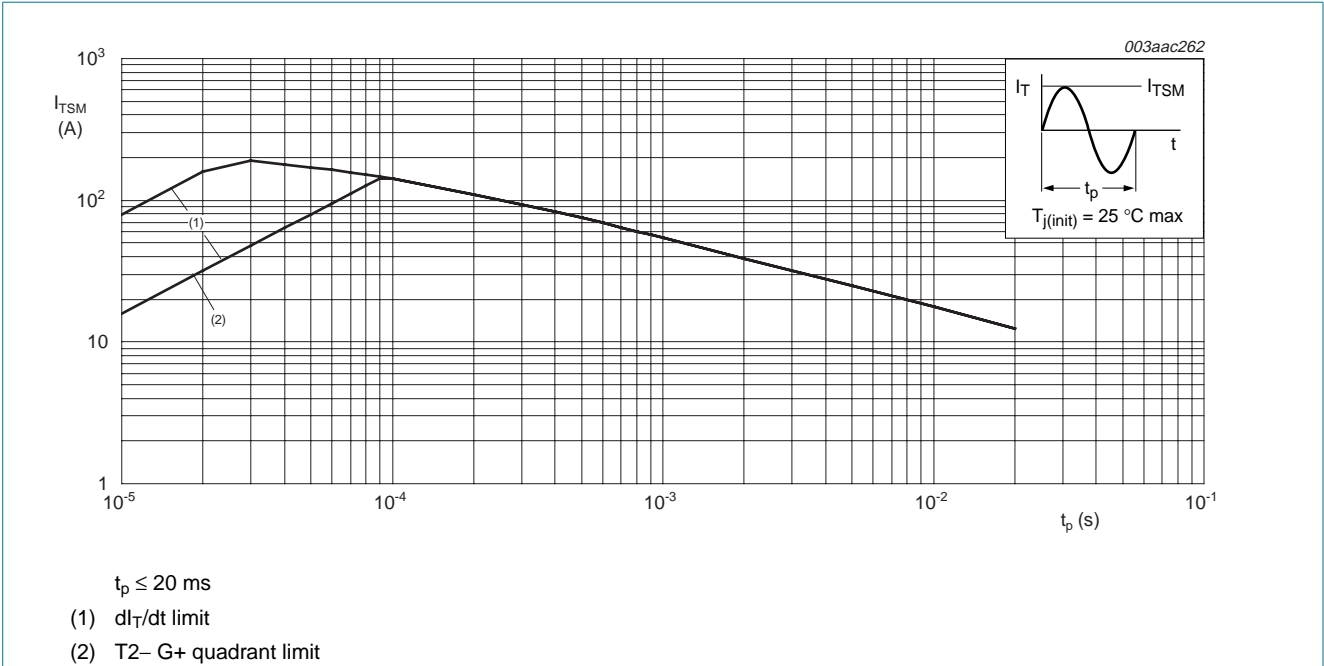

Fig 3. Non-repetitive peak on-state current as a function of pulse width; maximum values

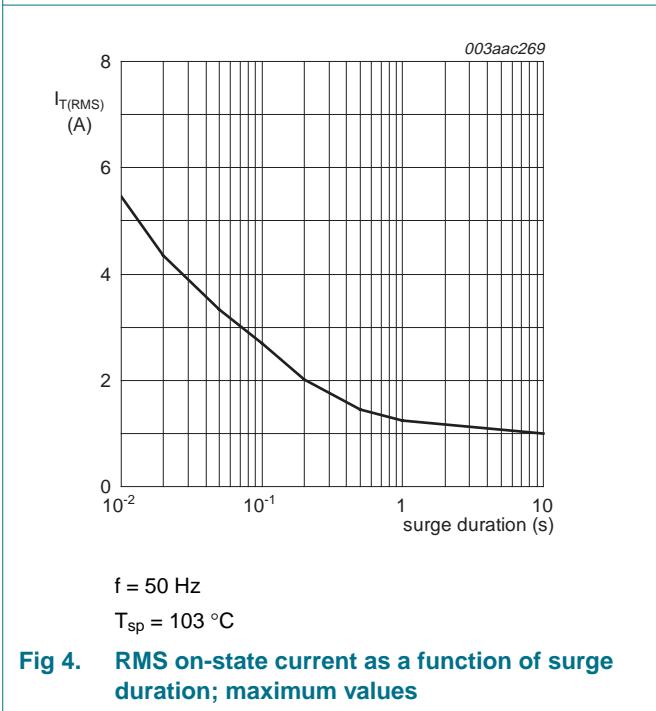

Fig 4. RMS on-state current as a function of surge duration; maximum values

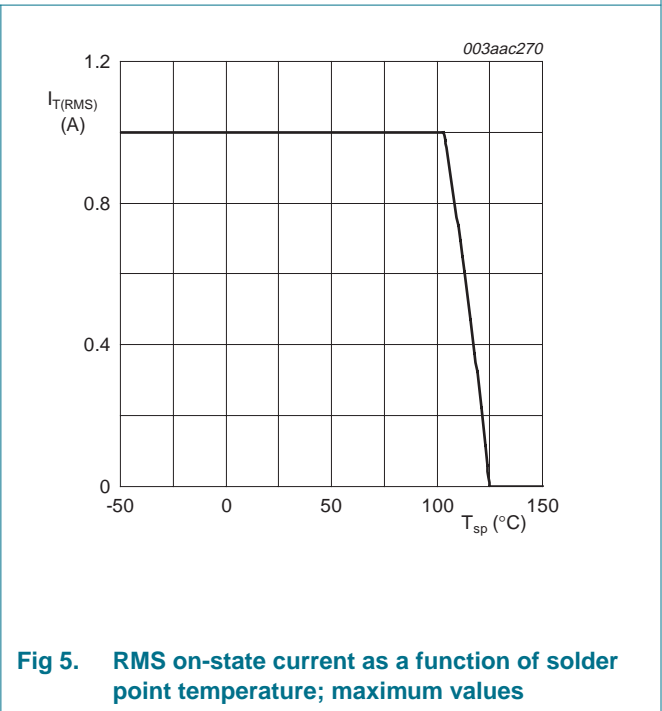

Fig 5. RMS on-state current as a function of solder point temperature; maximum values

5. Thermal characteristics

Table 4. Thermal characteristics

Symbol	Parameter	Conditions	Min	Typ	Max	Unit
$R_{th(j-sp)}$	thermal resistance from junction to solder point	full cycle; see Figure 6	-	-	15	K/W
$R_{th(j-a)}$	thermal resistance from junction to ambient	full cycle				
		for minimum footprint see Figure 13	-	156	-	K/W
		for pad area see Figure 14	-	70	-	K/W

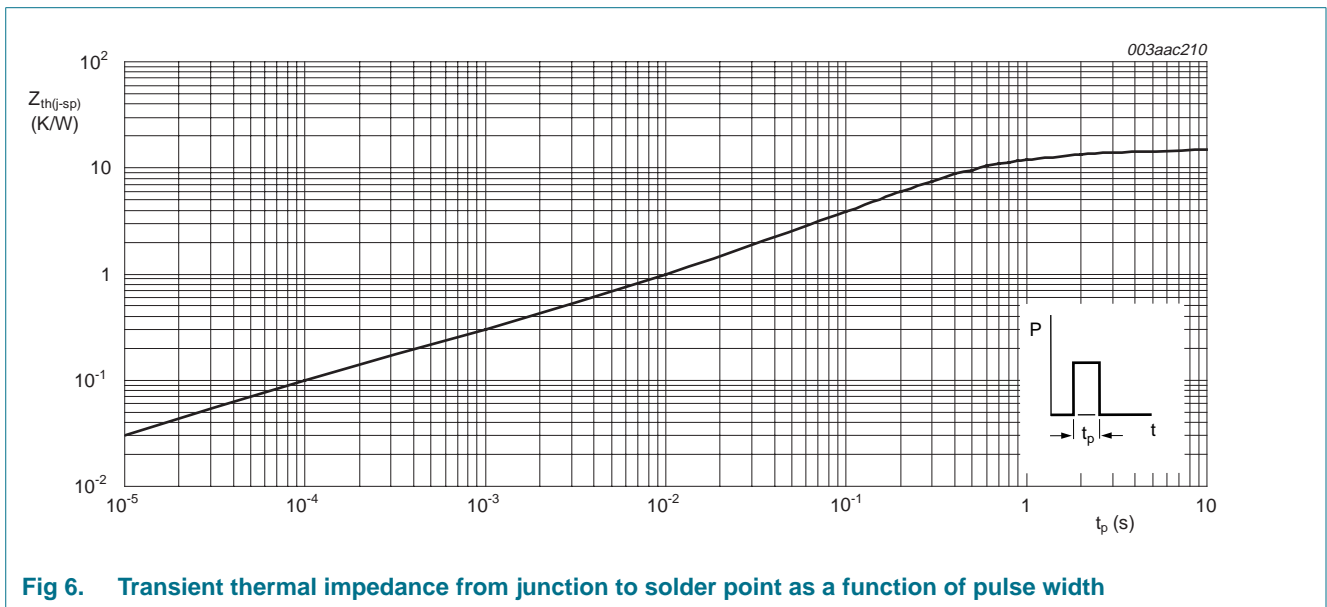

Fig 6. Transient thermal impedance from junction to solder point as a function of pulse width

6. Static characteristics

Table 5. Static characteristics

$T_j = 25\text{ °C}$ unless otherwise specified.

Symbol	Parameter	Conditions	Min	Typ	Max	Unit
I_{GT}	gate trigger current	$V_D = 12\text{ V}$; $I_T = 0.1\text{ A}$; see Figure 8				
		T2+ G+	-	-	3	mA
		T2+ G-	-	-	3	mA
		T2- G-	-	-	3	mA
		T2- G+	-	-	5	mA
I_L	latching current	$V_D = 12\text{ V}$; $I_G = 0.1\text{ A}$; see Figure 10				
		T2+ G+	-	-	7	mA
		T2+ G-	-	-	20	mA
		T2- G-	-	-	7	mA
		T2- G+	-	-	7	mA
I_H	holding current	$V_D = 12\text{ V}$; $I_G = 0.1\text{ A}$; see Figure 11	-	-	7	mA
V_T	on-state voltage	$I_T = 1\text{ A}$; see Figure 9	-	1.3	1.6	V
V_{GT}	gate trigger voltage	$V_D = 12\text{ V}$; $I_T = 0.1\text{ A}$; see Figure 7	-	-	1.3	V
		$V_D = V_{DRM}$; $I_T = 0.1\text{ A}$; $T_j = 125\text{ °C}$	0.2	-	-	V
I_D	off-state current	$V_D = V_{DRM(max)}$; $T_j = 125\text{ °C}$	-	-	0.5	mA

7. Dynamic characteristics

Table 6. Dynamic characteristics

Symbol	Parameter	Conditions	Min	Typ	Max	Unit
dV_D/dt	rate of rise of off-state voltage	$V_{DM} = 0.67V_{DRM(max)}$; $T_j = 110\text{ }^\circ\text{C}$; exponential waveform; gate open circuit	10	-	-	V/ μs
dV_{com}/dt	rate of change of commutating voltage	$V_{DM} = 400\text{ V}$; $T_j = 110\text{ }^\circ\text{C}$; $I_{TM} = 1\text{ A}$; $di_{com}/dt = 0.44\text{ A/ms}$	0.5	-	-	V/ μs

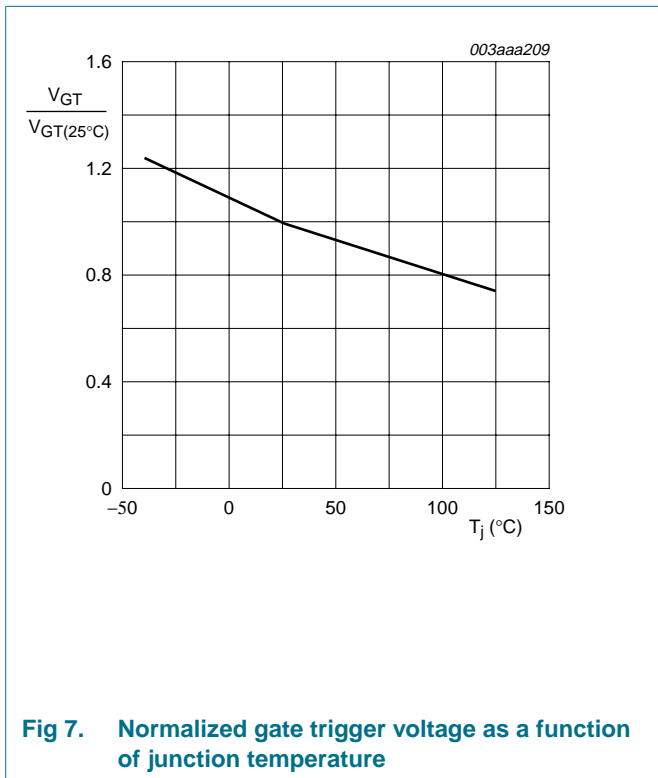

Fig 7. Normalized gate trigger voltage as a function of junction temperature

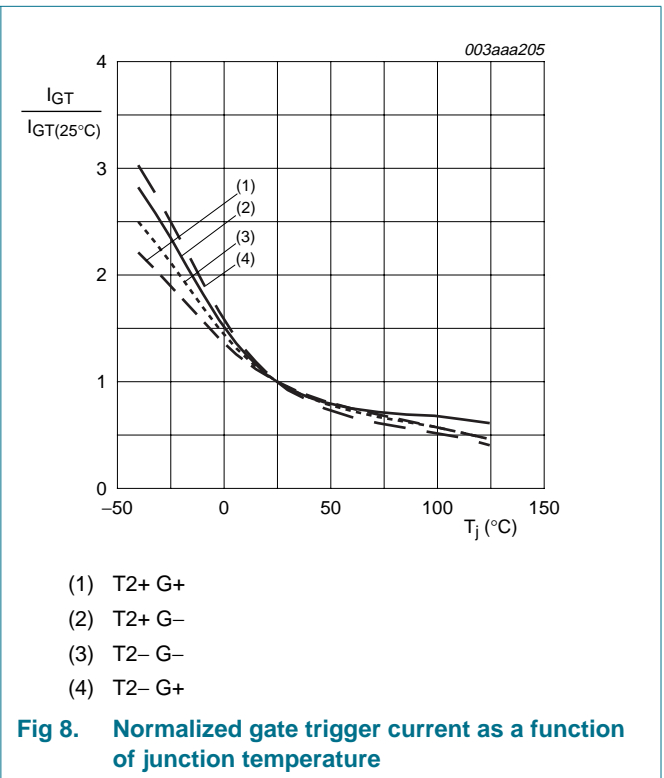
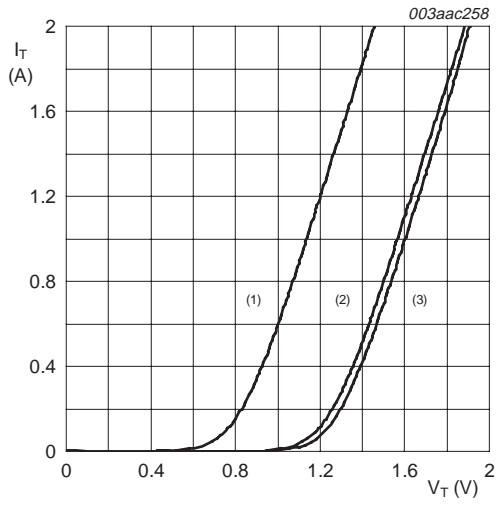

Fig 8. Normalized gate trigger current as a function of junction temperature



$V_o = 1.254 \text{ V}; R_s = 0.31 \Omega$
 (1) $T_j = 125 \text{ }^\circ\text{C}$; typical values
 (2) $T_j = 125 \text{ }^\circ\text{C}$; maximum values
 (3) $T_j = 25 \text{ }^\circ\text{C}$; maximum values

Fig 9. On-state current as a function of on-state voltage

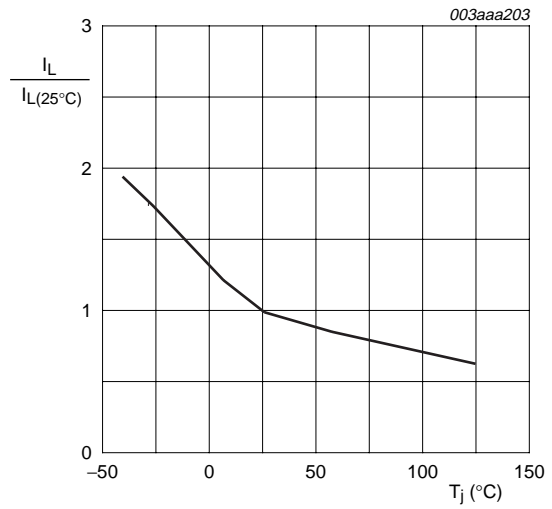

Fig 10. Normalized latching current as a function of junction temperature

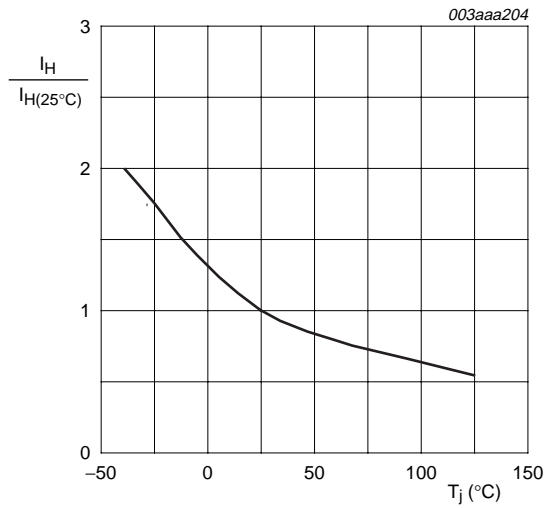

Fig 11. Normalized holding current as a function of junction temperature

8. Package outline

Plastic surface-mounted package with increased heatsink; 4 leads

SOT223

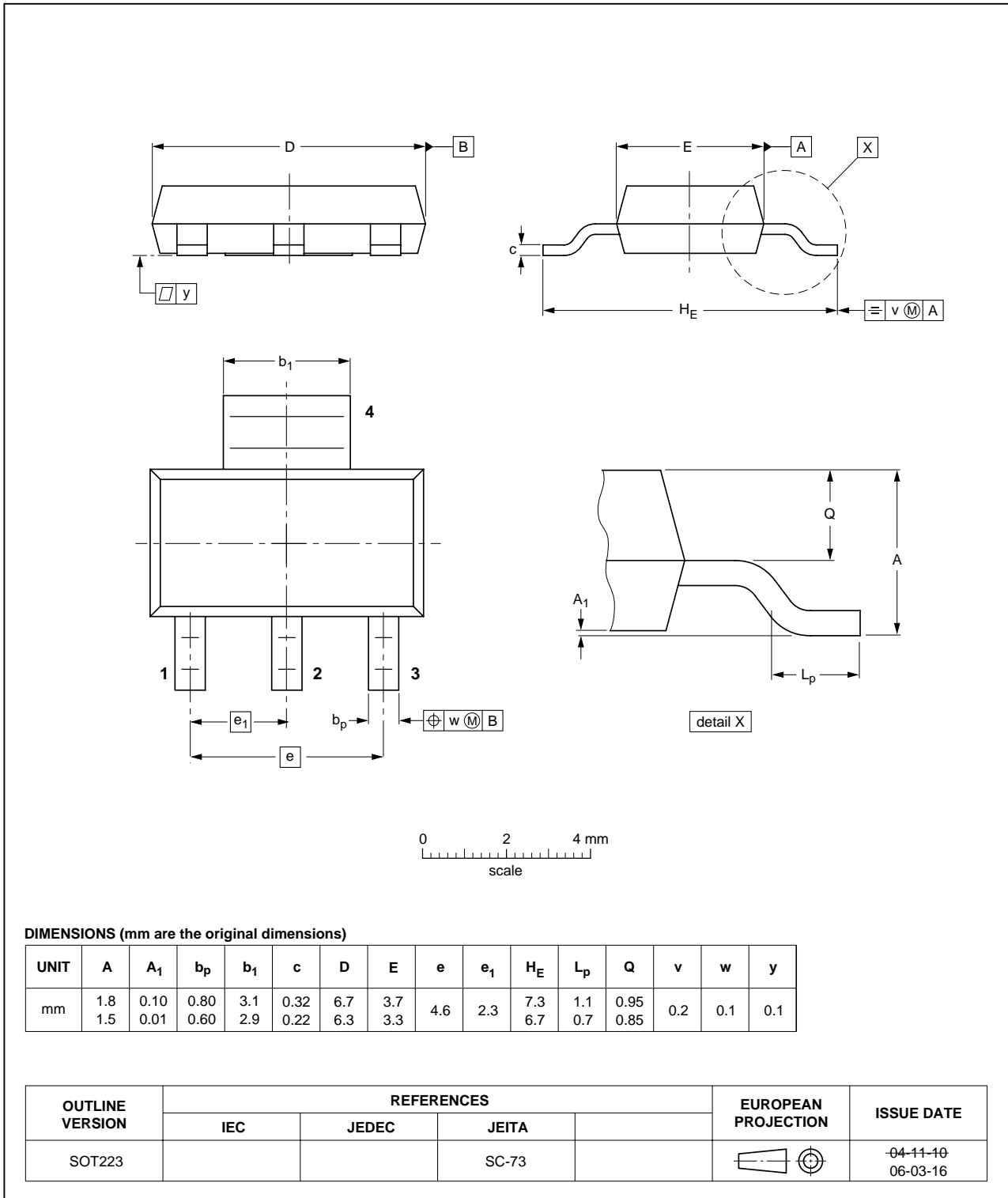
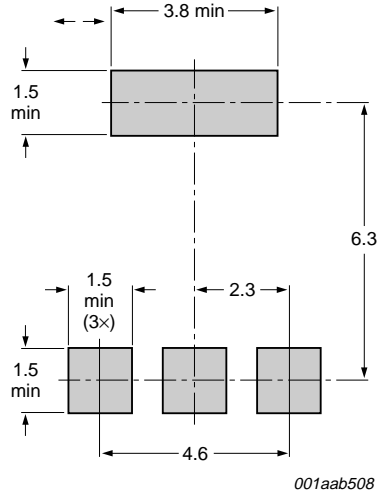

Fig 12. Package outline SOT223 (SC-73)

9. Mounting

9.1 Mounting instructions



All dimensions are in mm

Fig 13. Minimum footprint SOT223

9.2 Printed-circuit board

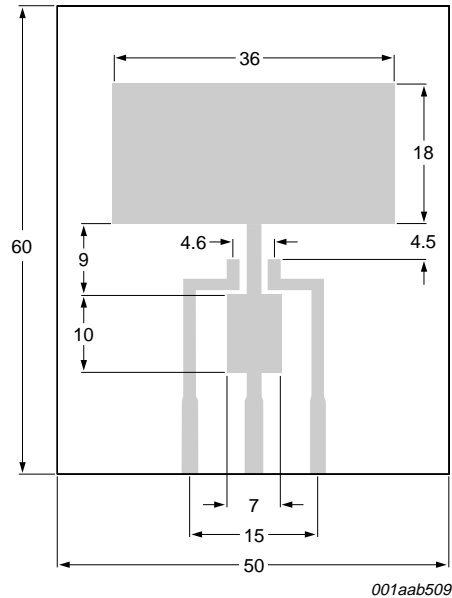

All dimensions are in mm

Printed-circuit board: FR4 epoxy glass (1.6 mm thick), copper laminate (35 μm thick)

Fig 14. Printed-circuit board pad area SOT223

10. Revision history

Table 7. Revision history

Document ID	Release date	Data sheet status	Change notice	Supersedes
OT406_1	20080519	Product data sheet	-	-

11. Legal information

11.1 Data sheet status

Document status ^{[1][2]}	Product status ^[3]	Definition
Objective [short] data sheet	Development	This document contains data from the objective specification for product development.
Preliminary [short] data sheet	Qualification	This document contains data from the preliminary specification.
Product [short] data sheet	Production	This document contains the product specification.

[1] Please consult the most recently issued document before initiating or completing a design.

[2] The term 'short data sheet' is explained in section "Definitions".

[3] The product status of device(s) described in this document may have changed since this document was published and may differ in case of multiple devices. The latest product status information is available on the Internet at URL <http://www.nxp.com>.

11.2 Definitions

Draft — The document is a draft version only. The content is still under internal review and subject to formal approval, which may result in modifications or additions. NXP Semiconductors does not give any representations or warranties as to the accuracy or completeness of information included herein and shall have no liability for the consequences of use of such information.

Short data sheet — A short data sheet is an extract from a full data sheet with the same product type number(s) and title. A short data sheet is intended for quick reference only and should not be relied upon to contain detailed and full information. For detailed and full information see the relevant full data sheet, which is available on request via the local NXP Semiconductors sales office. In case of any inconsistency or conflict with the short data sheet, the full data sheet shall prevail.

11.3 Disclaimers

General — Information in this document is believed to be accurate and reliable. However, NXP Semiconductors does not give any representations or warranties, expressed or implied, as to the accuracy or completeness of such information and shall have no liability for the consequences of use of such information.

Right to make changes — NXP Semiconductors reserves the right to make changes to information published in this document, including without limitation specifications and product descriptions, at any time and without notice. This document supersedes and replaces all information supplied prior to the publication hereof.

Suitability for use — NXP Semiconductors products are not designed, authorized or warranted to be suitable for use in medical, military, aircraft, space or life support equipment, nor in applications where failure or malfunction of an NXP Semiconductors product can reasonably be expected to result in personal injury, death or severe property or environmental

damage. NXP Semiconductors accepts no liability for inclusion and/or use of NXP Semiconductors products in such equipment or applications and therefore such inclusion and/or use is at the customer's own risk.

Applications — Applications that are described herein for any of these products are for illustrative purposes only. NXP Semiconductors makes no representation or warranty that such applications will be suitable for the specified use without further testing or modification.

Limiting values — Stress above one or more limiting values (as defined in the Absolute Maximum Ratings System of IEC 60134) may cause permanent damage to the device. Limiting values are stress ratings only and operation of the device at these or any other conditions above those given in the Characteristics sections of this document is not implied. Exposure to limiting values for extended periods may affect device reliability.

Terms and conditions of sale — NXP Semiconductors products are sold subject to the general terms and conditions of commercial sale, as published at <http://www.nxp.com/profile/terms>, including those pertaining to warranty, intellectual property rights infringement and limitation of liability, unless explicitly otherwise agreed to in writing by NXP Semiconductors. In case of any inconsistency or conflict between information in this document and such terms and conditions, the latter will prevail.

No offer to sell or license — Nothing in this document may be interpreted or construed as an offer to sell products that is open for acceptance or the grant, conveyance or implication of any license under any copyrights, patents or other industrial or intellectual property rights.

Quick reference data — The Quick reference data is an extract of the product data given in the Limiting values and Characteristics sections of this document, and as such is not complete, exhaustive or legally binding.

11.4 Trademarks

Notice: All referenced brands, product names, service names and trademarks are the property of their respective owners.

12. Contact information

For more information, please visit: <http://www.nxp.com>

For sales office addresses, please send an email to: salesaddresses@nxp.com

13. Contents

1	Product profile	1
1.1	General description	1
1.2	Features	1
1.3	Applications	1
1.4	Quick reference data	1
2	Pinning information	1
3	Ordering information	2
4	Limiting values	2
5	Thermal characteristics	5
6	Static characteristics	6
7	Dynamic characteristics	7
8	Package outline	9
9	Mounting	10
9.1	Mounting instructions	10
9.2	Printed-circuit board	10
10	Revision history	11
11	Legal information	12
11.1	Data sheet status	12
11.2	Definitions	12
11.3	Disclaimers	12
11.4	Trademarks	12
12	Contact information	12
13	Contents	13

Please be aware that important notices concerning this document and the product(s) described herein, have been included in section 'Legal information'.



© NXP B.V. 2008.

All rights reserved.

For more information, please visit: <http://www.nxp.com>

For sales office addresses, please send an email to: salesaddresses@nxp.com

Date of release: 19 May 2008

Document identifier: OT406_1

Mouser Electronics

Authorized Distributor

Click to View Pricing, Inventory, Delivery & Lifecycle Information:

[NXP:](#)

[OT406,135](#)



Компания «ЭлектроПласт» предлагает заключение долгосрочных отношений при поставках импортных электронных компонентов на взаимовыгодных условиях!

Наши преимущества:

- Оперативные поставки широкого спектра электронных компонентов отечественного и импортного производства напрямую от производителей и с крупнейших мировых складов;
- Поставка более 17-ти миллионов наименований электронных компонентов;
- Поставка сложных, дефицитных, либо снятых с производства позиций;
- Оперативные сроки поставки под заказ (от 5 рабочих дней);
- Экспресс доставка в любую точку России;
- Техническая поддержка проекта, помощь в подборе аналогов, поставка прототипов;
- Система менеджмента качества сертифицирована по Международному стандарту ISO 9001;
- Лицензия ФСБ на осуществление работ с использованием сведений, составляющих государственную тайну;
- Поставка специализированных компонентов (Xilinx, Altera, Analog Devices, Intersil, Interpoint, Microsemi, Aeroflex, Peregrine, Syfer, Eurofarad, Texas Instrument, Miteq, Cobham, E2V, MA-COM, Hittite, Mini-Circuits, General Dynamics и др.);

Помимо этого, одним из направлений компании «ЭлектроПласт» является направление «Источники питания». Мы предлагаем Вам помощь Конструкторского отдела:

- Подбор оптимального решения, техническое обоснование при выборе компонента;
- Подбор аналогов;
- Консультации по применению компонента;
- Поставка образцов и прототипов;
- Техническая поддержка проекта;
- Защита от снятия компонента с производства.



Как с нами связаться

Телефон: 8 (812) 309 58 32 (многоканальный)

Факс: 8 (812) 320-02-42

Электронная почта: org@eplast1.ru

Адрес: 198099, г. Санкт-Петербург, ул. Калинина, дом 2, корпус 4, литера А.