

THIS DRAWING IS UNPUBLISHED.		RELEASED FOR PUBLICATION		20						
COPYRIGHT 20		BY -		ALL RIGHTS RESERVED.						
M32x1.5	18-25	25.4		12	31	40	DLX-32-LM	METAL CABLE GLAND M32 (18-25), THREAD LENGTHEN 金属加长螺纹接头 M32 (18-25)	T3609320202-000	
M32x1.5	13-20	20.4		12	31	40	DLX-32-LMT	METAL CABLE GLAND M32 (13-20), THREAD LENGTHEN 金属加长螺纹接头 M32 (13-20)	T3609320212-000	
M63x1.5	37-44		10		41	70	DLX-63-M	METAL CABLE GLAND M63(37-44) 金属接头 M63 (37-44)		T3609630102-000
M63x1.5	29-35	36	10.5		40	67	DLX-63-MT	METAL CABLE GLAND M63(29-35) 金属接头 M63 (29-35)	T3609630112-000	
M50x1.5	32-38	39	9		37	57	DLX-50-M	METAL CABLE GLAND M50(32-38) 金属接头 M50 (32-38)	T3609500102-000	T3609500102-001
M50x1.5	29-36	36.5	9		37	57	DLX-50-M	METAL CABLE GLAND M50(29-36) 金属接头 M50 (29-36)	T3609500122-000	
M50x1.5	22-32		9		38.5	55	DLX-50-MT	METAL CABLE GLAND M50(22-32) 金属接头 M50 (22-32)		T3609500112-000
M40x1.5	22-32	33	8		37	50	DLX-40-M	METAL CABLE GLAND M40(22-32) 金属接头 M40 (22-32)	T3609400102-000	T3609400102-001
M40x1.5	20-26	26.5	8		37	50	DLX-40-MT	METAL CABLE GLAND M40(20-26) 金属接头 M40 (20-26)	T3609400112-000	
M32x1.5	18-25	25.4	8		31	40	DLX-32-M	METAL CABLE GLAND M32(18-25) 金属接头 M32 (18-25)	T3609320102-000	
M32x1.5	13-20	20.4	8		31	40	DLX-32-MT	METAL CABLE GLAND M32(13-20) 金属接头 M32 (13-20)	T3609320112-000	
M25x1.5	13-18	18.4		12	26	30	DLX-25-LM	METAL CABLE GLAND M25 (13-18), THREAD LENGTHEN 金属加长螺纹接头 M25 (13-18)	T3609250202-000	
M25x1.5	13-18	18.4	7		26	30	DLX-25-M	METAL CABLE GLAND M25(13-18) 金属接头 M25 (13-18)	T3609250102-000	
M25x1.5	9-16	16.4		12	26	30	DLX-25-LMT	METAL CABLE GLAND M25 (9-16), THREAD LENGTHEN 金属加长螺纹接头 M25 (9-16)	T3609250212-000	
M25x1.5	9-16	16.4	7		26	30	DLX-25-MT	METAL CABLE GLAND M25(9-16) 金属接头 M25 (9-16)	T3609250112-000	
M20x1.5	10-14	13.8	6		24	24	DLX-20-MB	METAL CABLE GLAND M20(10-14) 金属接头 M20 (10-14)	T3609200122-000	
M20x1.5	6-12	12.2		10	23	22	DLX-20-LM	METAL CABLE GLAND M20 (6-12), THREAD LENGTHEN 金属加长螺纹接头 M20 (6-12)	T3609200202-000	
M20x1.5	6-12	12.2	6		23	22	DLX-20-M	METAL CABLE GLAND M20(6-12) 金属接头 M20 (6-12)	T3609200102-000	
M20x1.5	5-9	9.2		10	23	22	DLX-20-LMT	METAL CABLE GLAND M20 (5-9), THREAD LENGTHEN 金属加长螺纹接头 M20 (5-9)	T3609200222-000	
M20x1.5	5-9	9.2	6		23	22	DLX-20-MT	METAL CABLE GLAND M20(5-9) 金属接头 M20 (5-9)	T3609200112-000	
M16x1.5	5-10	10.2		10	22	20	DLX-16-LMB	METAL CABLE GLAND M16 (5-10), THREAD LENGTHEN 金属加长螺纹接头 M16 (5-10)	T3609160222-000	
M16x1.5	5-10	10.2	6		22	20	DLX-16-MB	METAL CABLE GLAND M16(5-10) 金属接头 M16 (5-10)	T3609160122-000	
M16x1.5	4-8	8.5		10	21	19	DLX-16-LM	METAL CABLE GLAND M16 (4-8), THREAD LENGTHEN 金属加长螺纹接头 M16 (4-8)	T3609160202-000	
M16x1.5	4-8	8.5	6		21	19	DLX-16-M	METAL CABLE GLAND M16(4-8) 金属接头 M16 (4-8)	T3609160102-000	
M16x1.5	2-6	6.5		21	19	19	DLX-16-MT	METAL CABLE GLAND M16(2-6) 金属接头 M16 (2-6)	T3609160112-000	
M12x1.5	3-6.5	6.8		8	25	14	DLX-12-LM	METAL CABLE GLAND M12 (3-6.5), LENGTHEN 金属加长接头 M12 (3-6.5)	T3609120202-000	
M12x1.5	3-6.5	6.8	5		25	14	DLX-12-M	METAL CABLE GLAND M12(3-6.5) 金属接头 M12 (3-6.5)	T3609120102-000	
M12x1.5	2-5	5.3	5		25	14	DLX-12-MT	METAL CABLE GLAND M12(2-5) 金属接头 M12 (2-5)	T3609120112-000	
PG48	37-44	44.5	10		41	65	DLX-48-MS	METAL CABLE GLAND PG48(37-44) 金属接头 PG48 (37-44)	T3609480101-000	
PG48	29-35	36	10		30	64	DLX-48-MTS	METAL CABLE GLAND PG48(29-35) 金属接头 PG48 (29-35)	T3609480111-000	
PG42	30-38		9		40	58	DLX-42-MS	METAL CABLE GLAND PG42(30-38) 金属接头 PG42 (30-38)		T3609420101-000
PG42	25-31	31.5	9		37	57	DLX-42-MTS	METAL CABLE GLAND PG42(25-31) 金属接头 PG42 (25-31)	T3609420111-000	
PG36	22-32	33		15	39	50	DLX-36-LMS	METAL CABLE GLAND PG36 (22-32), LENGTHEN 金属加长接头 PG36 (22-32)	T3609360201-000	
PG36	22-32	33	8		38	50	DLX-36-MS	METAL CABLE GLAND PG36(22-32) 金属接头 PG36 (22-32)	T3609360101-000	
PG36	20-26	26.5	8		38	50	DLX-36-MTS	METAL CABLE GLAND PG36(20-26) 金属接头 PG36 (20-26)	T3609360111-000	
PG29	18-25	25.4		15	33	40	DLX-29-LMS	METAL CABLE GLAND PG29 (18-25), LENGTHEN 金属加长接头 PG29 (18-25)	T3609290201-000	
PG29	18-25	25.4	8		30	40	DLX-29-MS	METAL CABLE GLAND PG29(18-25) 金属接头 PG29 (18-25)	T3609290101-000	T3609290101-001
PG29	13-20	20.4	8		30	40	DLX-29-MTS	METAL CABLE GLAND PG29(13-20) 金属接头 PG29 (13-20)	T3609290111-000	
PG21	13-18	18.4		12	25	30	DLX-21-LMS	METAL CABLE GLAND PG21 (13-18), LENGTHEN 金属加长接头 PG21 (13-18)	T3609210201-000	
PG21	13-18	18.4	7		25	30	DLX-21-MS	METAL CABLE GLAND PG21(13-18) 金属接头 PG21 (13-18)	T3609210101-000	
PG21	9-16	16.4	7		25	30	DLX-21-MTS	METAL CABLE GLAND PG21(9-16) 金属接头 PG21 (9-16)	T3609210111-000	
PG16	10-14	13.8	6.5		23.5	24	DLX-16-MS	METAL CABLE GLAND PG16(10-14) 金属接头 PG16 (10-14)	T3609160101-000	
PG16	7-12	12.2	6.5		23.5	24	DLX-16-MTS	METAL CABLE GLAND PG16(7-12) 金属接头 PG16 (7-12)	T3609160111-000	
PG13.5	6-12	12.2	6.5		23.5	22	DLX-13.5-MS	METAL CABLE GLAND PG13.5(6-12) 金属接头 PG13.5 (6-12)	T3609130101-000	
PG13.5	5-9	9.2	6.5		23.5	22	DLX-13.5-MTS	METAL CABLE GLAND PG13.5(5-9) 金属接头 PG13.5 (5-9)	T3609130111-000	
PG11	5-10	10.2	6		24	21	DLX-11-MS	METAL CABLE GLAND PG11(5-10) 金属接头 PG11 (5-10)	T3609110101-000	
PG11	3-7	7.2	6		24	21	DLX-11-MTS	METAL CABLE GLAND PG11(3-7) 金属接头 PG11 (3-7)	T3609110111-000	
PG11			6		24	21	DLX-11-MSN	METAL CABLE GLAND, WITHOUT INNER SEALING 金属接头 PG11, 无内衬圈	T3609110121-000	
PG9	4-8	8.5	6		24	17	DLX-9-MS	METAL CABLE GLAND PG9(4-8) 金属接头 PG9 (4-8)	T3609090101-000	
PG9	2-6	6.5	6		24	17	DLX-9-MTS	METAL CABLE GLAND PG9(2-6) 金属接头 PG9 (2-6)	T3609090111-000	
PG7	3-6.5	8.5		6	25	17	DLX-7-MES	METAL CABLE GLAND PG7 (3-6.5), LARGE 金属接头 PG7 (3-6.5), 加大型	T3609070121-000	
PG7	3-6.5	6.8	5		25	14	DLX-7-MS	METAL CABLE GLAND PG7(3-6.5) 金属接头 PG7 (3-6.5)	T3609070101-000	
PG7	2-5	5.3	5		25	14	DLX-7-MTS	METAL CABLE GLAND PG7(2-5) 金属接头 PG7 (2-5)	T3609070111-000	

REVISIONS					
P	LTR	DESCRIPTION	DATE	DWN	APVD
B2		ECR-18-010224	30JUN2018	CH	CW
B3		ECR-18-020020	26DEC2018	YC	CW
B4		ECR-19-002559	16FEB2019	WOR	CW
B5		ECR-19-004297	21MAR2019	SR	CW

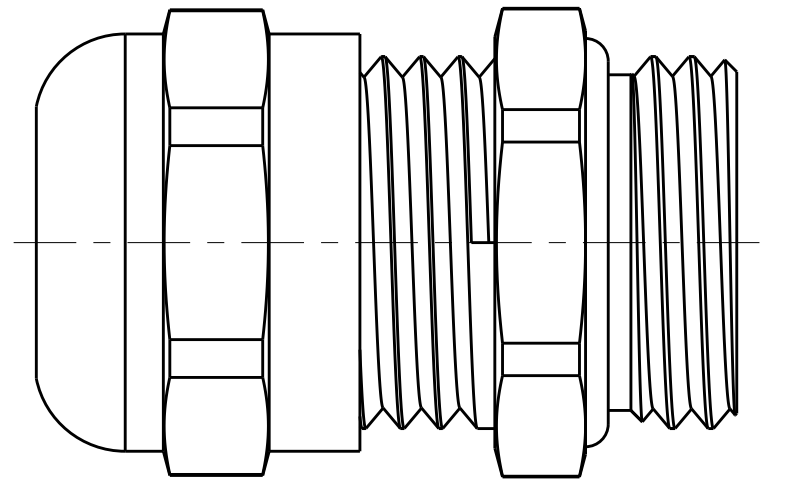
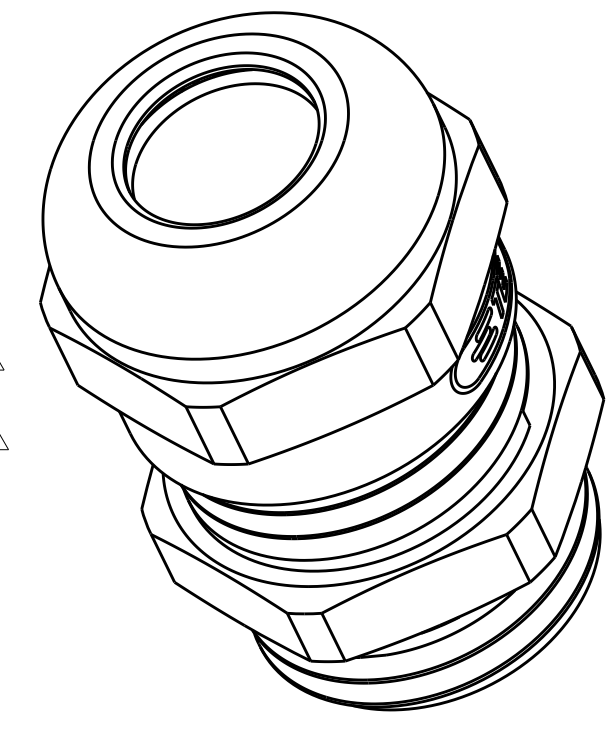
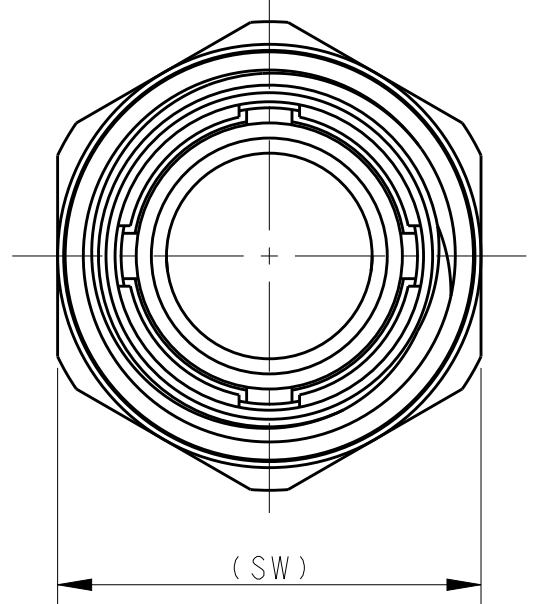
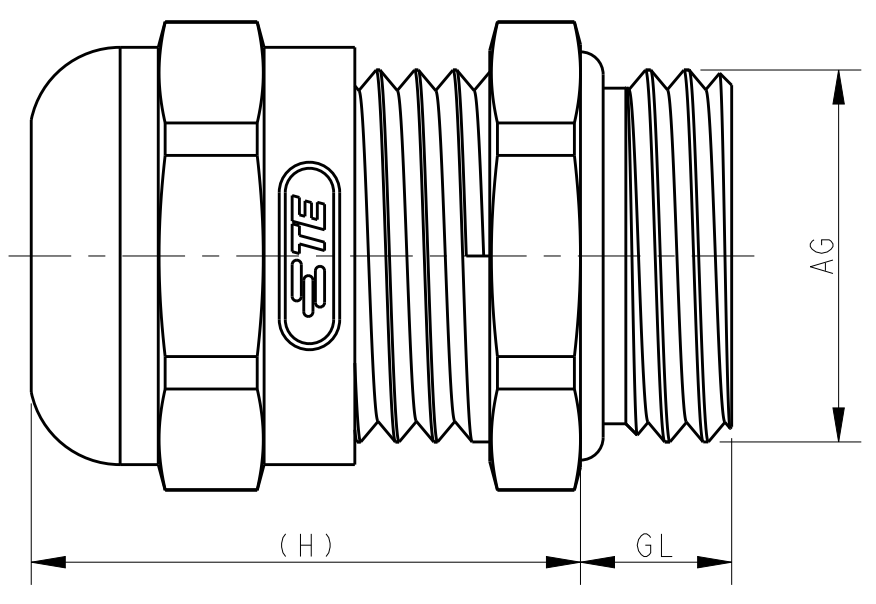

PART NUMBER SHOWN WITH TE LOGO
成品料号 (带TE LOGO)

PART NUMBER SHOWN WITHOUT LOGO
成品料号 (不带TE LOGO)
EXCEPT THE TE LOGO, ALL DIMENSIONS ARE SAME AS CORRESPONDING PART NUMBER WITH TE LOGO
除TE LOGO差异外,不带TE LOGO与带TE LOGO对应型号之间,所有尺寸均相同。

NOTES/技术指标:

- 1. TECHNICAL CHARACTERISTICS/技术参数:
 - SHELL MATERIAL/主体材料: NICKEL PLATED BRASS/铜镀镍
 - SEAL MATERIAL/密封材料: ELASTIC RUBBER/弹性橡胶
 - PINCH RING MATERIAL/夹零件材料: PA
 - OPERATION TEMPERATURE/工作温度: -40°C~+100°C
 - PROTECTION DEGREE/防护等级: IP68 (EXCEPT T3609110121-000) (料号T3609110121-000除外)

WIRE RANGE/夹线范围: SEE TABLE/见表格

2. OBSOLETE /料号已停用

THIS DRAWING IS A CONTROLLED DOCUMENT.		DWN G.LNO.YAO 05JUN2015	TE Connectivity	
		CHK CHRIS.WANG 05JUN2015		
		APVD XIANG.XU 05JUN2015	NAME METAL CABLE GLAND	
DIMENSIONS: mm		TOLERANCES UNLESS OTHERWISE SPECIFIED:		PRODUCT SPEC
		0 PLC ± 1 PLC ± 2 PLC ± 3 PLC ± 4 PLC ± ANGLES ±		APPLICATION SPEC
MATERIAL		FINISH		WEIGHT
				Customer Drawing
SIZE A2	CAGE CODE	DRAWING NO. G-T360XXXXXXX000	RESTRICTED TO	
SCALE 5:1		SHEET 1 OF 1	REV B5	



Компания «ЭлектроПласт» предлагает заключение долгосрочных отношений при поставках импортных электронных компонентов на взаимовыгодных условиях!

Наши преимущества:

- Оперативные поставки широкого спектра электронных компонентов отечественного и импортного производства напрямую от производителей и с крупнейших мировых складов;
- Поставка более 17-ти миллионов наименований электронных компонентов;
- Поставка сложных, дефицитных, либо снятых с производства позиций;
- Оперативные сроки поставки под заказ (от 5 рабочих дней);
- Экспресс доставка в любую точку России;
- Техническая поддержка проекта, помощь в подборе аналогов, поставка прототипов;
- Система менеджмента качества сертифицирована по Международному стандарту ISO 9001;
- Лицензия ФСБ на осуществление работ с использованием сведений, составляющих государственную тайну;
- Поставка специализированных компонентов (Xilinx, Altera, Analog Devices, Intersil, Interpoint, Microsemi, Aeroflex, Peregrine, Syfer, Eurofarad, Texas Instrument, Miteq, Cobham, E2V, MA-COM, Hittite, Mini-Circuits, General Dynamics и др.);

Помимо этого, одним из направлений компании «ЭлектроПласт» является направление «Источники питания». Мы предлагаем Вам помощь Конструкторского отдела:

- Подбор оптимального решения, техническое обоснование при выборе компонента;
- Подбор аналогов;
- Консультации по применению компонента;
- Поставка образцов и прототипов;
- Техническая поддержка проекта;
- Защита от снятия компонента с производства.



Как с нами связаться

Телефон: 8 (812) 309 58 32 (многоканальный)

Факс: 8 (812) 320-02-42

Электронная почта: org@eplast1.ru

Адрес: 198099, г. Санкт-Петербург, ул. Калинина, дом 2, корпус 4, литера А.