ULTRA SMALL PACKAGE VOLTAGE REGULATOR

NO.EA-117-111018

OUTLINE

The R1100D Series are CMOS-based voltage regulator ICs with high accuracy output voltage and ultra-low supply current developed. Each of these ICs consists of a driver transistor, a voltage reference unit, an error amplifier, resistors for setting output voltage and a current limit circuit.

The output voltage of these ICs is fixed with high accuracy.

Even if V_{OUT} is shorted to the GND, the included current limit circuit protects the ICs from the destruction.

Since the package for these ICs is SON1408-3, high density mounting of the ICs on boards is possible.

FEATURES

- Supply current Typ. $0.8\mu\text{A}$ ($V_{OUT}=1.0\text{V}$, $V_{DD}=3.0\text{V}$)
- Dropout Voltage Typ. 20mV ($I_{OUT}=1\text{mA}$, $V_{OUT}=3.0\text{V}$)
- Output Voltage 0.9V to 4.0V (0.1V steps)
(For other voltages, please refer to MARK INFORMATION.)
- Output Voltage Accuracy $\pm 2.0\%$ ($1.2\text{V} \leq V_{OUT} \leq 4.0\text{V}$),
 $\pm 24\text{mV}$ ($V_{OUT} < 1.2\text{V}$)
- Temperature-Drift Coefficient of Output Voltage Typ. $\pm 100\text{ppm}/^\circ\text{C}$
- Line Regulation Typ. $0.05\%/V$
- Package SON1408-3
- Built-in Fold Back Protection Circuit Typ. 40mA (Current at short mode)
- Ceramic capacitors are recommended to be used with this IC $0.1\mu\text{F}$ or more

APPLICATIONS

- Power source for battery-powered equipment.
- Power source for cameras, VCRs, camcorders, hand-held audio instruments and hand-held communication equipment.
- Precision voltage references.

BLOCK DIAGRAM



SELECTION GUIDE

The output voltage for the ICs can be selected at the user's request.

Product Name	Package	Quantity per Reel	Pb Free	Halogen Free
R1100Dxx1C-TR-F	SON1408-3	9,000 pcs	Yes	Yes
xx: The output voltage can be designated in the range from 0.9V(09) to 4.0V(40) in 0.1V steps. (For other voltages, please refer to MARK INFORMATIONS.)				

PIN CONFIGURATION

● SON1408-3



PIN DESCRIPTION

● SON1408-3

Pin No	Symbol	Pin Description
1	V_{OUT}	Output pin
2	V_{DD}	Input Pin
3	GND	Ground Pin

ABSOLUTE MAXIMUM RATINGS

(GND=0V)

Symbol	Item	Rating	Unit
V_{IN}	Input Voltage	6.5	V
V_{OUT}	Output Voltage	$V_{SS}-0.3$ to $V_{IN}+0.3$	V
I_{OUT}	Output Current	180	mA
P_D	Power Dissipation * (SON1408-3)	250	mW
T_{opt}	Operating Temperature Range	-40 to 85	°C
T_{stg}	Storage Temperature Range	-55 to~ 125	°C

*) For Power Dissipation, please refer to PACKAGE INFORMATION.

ABSOLUTE MAXIMUM RATINGS

Electronic and mechanical stress momentarily exceeded absolute maximum ratings may cause the permanent damages and may degrade the life time and safety for both device and system using the device in the field.

The functional operation at or over these absolute maximum ratings is not assured.

ELECTRICAL CHARACTERISTICS

• R1100D301C

T_{opt}=25°C

Symbol	Item	Test Conditions	Min.	Typ.	Max.	Unit
V _{OUT}	Output Voltage	V _{IN} =5.0V 10μA ≤ I _{OUT} ≤ 10mA	2.940	3.000	3.060	V
I _{OUT}	Output Current	V _{IN} =5.0V	100			mA
ΔV _{OUT} /ΔI _{OUT}	Load Regulation	V _{IN} =5.0V, 1mA ≤ I _{OUT} ≤ 50mA		35	60	mV
V _{DIF}	Dropout Voltage	I _{OUT} =1mA		20	30	mV
I _{SS}	Supply Current	V _{IN} =5.0V		1.5	3.0	μA
ΔV _{OUT} /ΔV _{IN}	Line Regulation	I _{OUT} =1mA Set V _{OUT} +0.5V ≤ V _{IN} ≤ 6.0V	-0.20		0.20	%/V
V _{IN}	Input Voltage				6.0	V
ΔV _{OUT} /ΔT _{opt}	Output Voltage Temperature Coefficient	I _{OUT} =10mA -40°C ≤ T _{opt} ≤ 85°C		±100		ppm/ °C
I _{SC}	Short Current Limit	V _{OUT} =0V		40		mA

ELECTRICAL CHARACTERISTICS BY OUTPUT VOLTAGE

T_{opt}=25°C

Part Number	Output Voltage				Output Current			Load Regulation			Dropout Voltage		
	V _{OUT} [V]				I _{OUT} [mA]			ΔV _{OUT} /ΔI _{OUT} [mV]			V _{DIF} [mV]		
	Condi- tions	MIN.	TYP.	MAX.	Condi- tions	MIN.	TYP.	Condi- tions	TYP.	MAX.	Condi- tions	TYP.	MAX.
R1100D091C	V _{IN} - Set V _{OUT} =2.0V	0.876	0.900	0.924	V _{IN} - Set V _{OUT} =2.0V	35		V _{IN} -Set V _{OUT} =2.0V 1mA ≤ I _{OUT} ≤ 20mA	7.5	20	I _{OUT} =1mA	380	750
R1100D101C		0.976	1.000	1.024								280	700
R1100D111C		1.076	1.100	1.124								200	600
R1100D121C		1.176	1.200	1.224								100	400
R1100D131C		1.274	1.300	1.326									
R1100D141C		1.372	1.400	1.428								50	100
R1100D151C		1.470	1.500	1.530									
R1100D161C		1.568	1.600	1.632								25	50
R1100D171C		1.666	1.700	1.734									
R1100D181C		1.764	1.800	1.836									
R1100D191C		1.862	1.900	1.938									
R1100D201C		1.960	2.000	2.040									
R1100D211C		2.058	2.100	2.142									
R1100D221C		2.156	2.200	2.244									
R1100D231C		2.254	2.300	2.346									
R1100D241C		2.352	2.400	2.448									
R1100D251C		2.450	2.500	2.550									
R1100D261C		2.548	2.600	2.652		100							
R1100D271C		2.646	2.700	2.754									
R1100D281C		2.744	2.800	2.856									
R1100D291C	2.842	2.900	2.958										
R1100D301C	2.940	3.000	3.060										
R1100D311C	3.038	3.100	3.162										
R1100D321C	3.136	3.200	3.264										
R1100D331C	3.234	3.300	3.366										
R1100D341C	3.332	3.400	3.468										
R1100D351C	3.430	3.500	2.570										
R1100D361C	3.528	3.600	3.672	V _{IN} -Set V _{OUT} =2.0V 1mA ≤ I _{OUT} ≤ 50mA	35	60	20	30					
R1100D371C	3.626	3.700	3.774										
R1100D381C	3.724	3.800	3.876										
R1100D391C	3.822	3.900	3.978										
R1100D401C	3.920	4.000	4.080										

ELECTRICAL CHARACTERISTICS

(Common characteristics)

Symbol	Item	Test Conditions	Min.	Typ.	Max.	Unit
$\Delta V_{OUT}/\Delta V_{IN}$	Line Regulation	$I_{OUT}=1\text{mA}$ Set $V_{OUT}+0.5\text{V} \leq V_{IN} \leq 6\text{V}$	-0.20		0.20	%/V
V_{IN}	Input Voltage		(1.2)		6.0	V
$\Delta V_{OUT}/\Delta T_{opt}$	Output Voltage Temperature Coefficient	$I_{OUT}=10\text{mA}$ $-40^{\circ}\text{C} \leq T_{opt} \leq 85^{\circ}\text{C}$		± 100		ppm/ °C
I_{SC}	Short Current Limit	$V_{OUT}=0\text{V}$		40		mA

ELECTRICAL CHARACTERISTICS BY OUTPUT VOLTAGE

Symbol	Item	Output Voltage	Conditions	Min.	Typ.	Max.	Unit
I_{SS}	Supply Current	$0.9\text{V} \leq V_{OUT} \leq 1.0\text{V}$	$V_{IN}=\text{Set } V_{OUT}+2.0\text{V}$		0.8	1.8	μA
		$1.1\text{V} \leq V_{OUT} \leq 1.4\text{V}$			1.0	2.4	
		$1.5\text{V} \leq V_{OUT} \leq 2.0\text{V}$			1.2	2.7	
		$2.1\text{V} \leq V_{OUT} \leq 4.0\text{V}$			1.5	3.0	

RECOMMENDED OPERATING CONDITIONS (ELECTRICAL CHARACTERISTICS)

All of electronic equipment should be designed that the mounted semiconductor devices operate within the recommended operating conditions. The semiconductor devices cannot operate normally over the recommended operating conditions, even if when they are used over such conditions by momentary electronic noise or surge. And the semiconductor devices may receive serious damage when they continue to operate over the recommended operating conditions.

OPERATION

These ICs, the output voltage V_{OUT} is detected by Feedback Resistors, and the detected output voltage is compared with a reference voltage by the error amplifier, so that a constant voltage is output.

A current limit circuit against short protection and a chip enable circuit are included.

TEST CIRCUITS

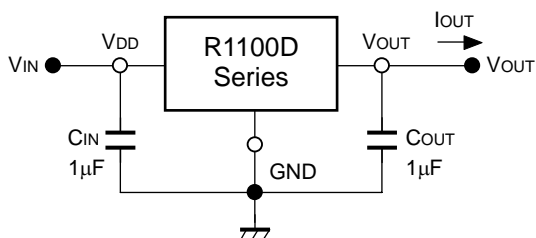

Standard Test Circuit

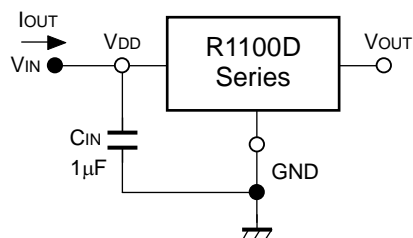

Test Circuit for Supply Current

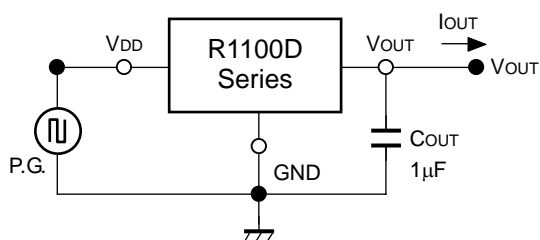

Test Circuit for Line Transient Response

TECHNICAL NOTES

In R1100D Series, a constant voltage can be obtained without using capacitors. However, when the wire connected V_{IN} is long, use a capacitor. Output noise can be reduced with using capacitor.

Insert capacitors with the capacitance of $0.1\mu\text{F}$ to $2.2\mu\text{F}$ between input/output pins and GND pin as close as possible.

TYPICAL CHARACTERISTICS

1) Output Voltage vs. Output Current



2) Output Voltage vs. Input Voltage

R1100D091C



R1100D091C



R1100D301C



R1100D301C



R1100D401C



R1100D401C

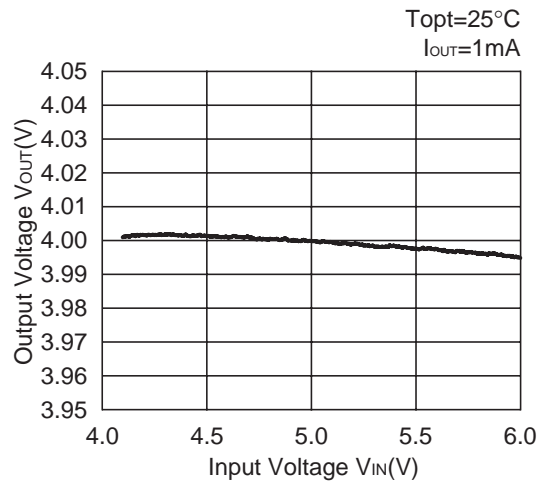

3) Dropout Voltage vs. Output Current

R1100D091C

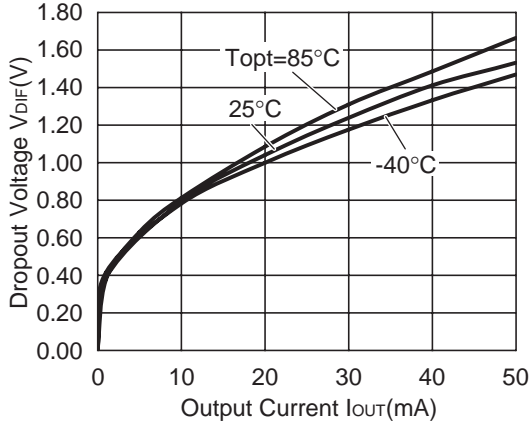

R1100D301C

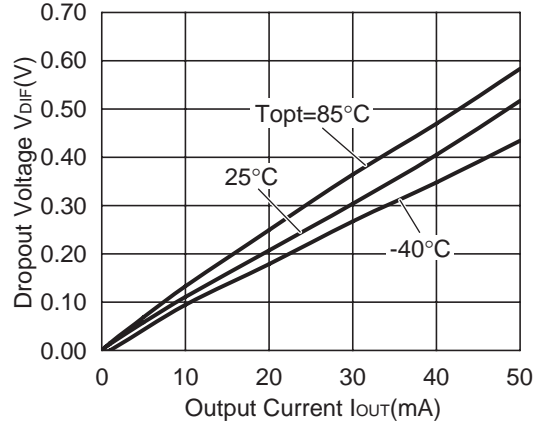

R1100D401C



4) Output Voltage vs. Temperature

R1100D091C

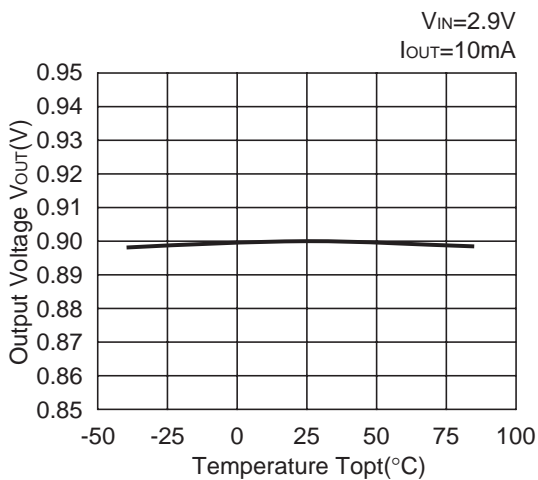

R1100D301C

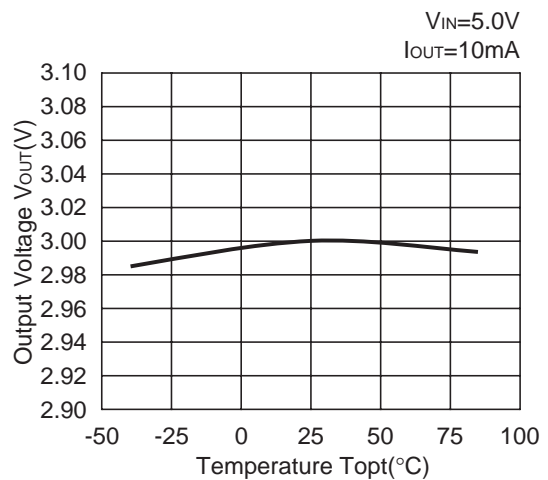

R1100D401C



5) Supply Current vs. Input Voltage

R1100D091C



R1100D301C

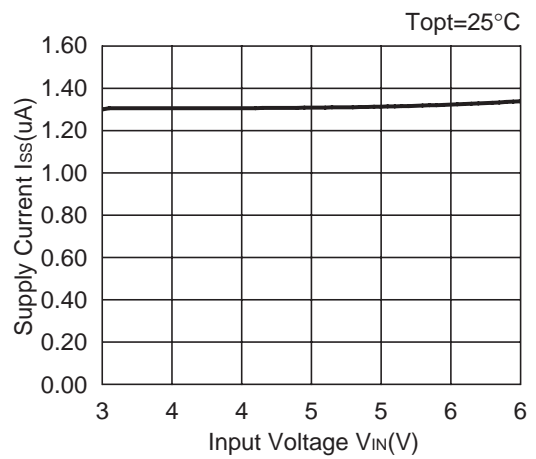

R1100D401C



6) Supply Current vs. Temperature

R1100D091C



R1100D301C



R1100D401C



7) Dropout Voltage vs. Set Output Voltage

R1100Dxx1C

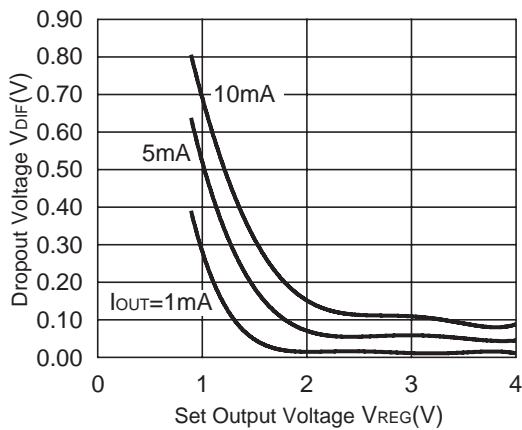

8) Line Transient Response

R1100D091C



R1100D091C



R1100D301C



R1100D301C



R1100D401C

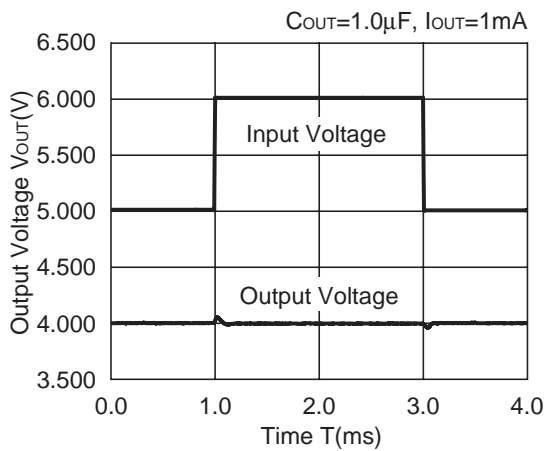

R1100D401C

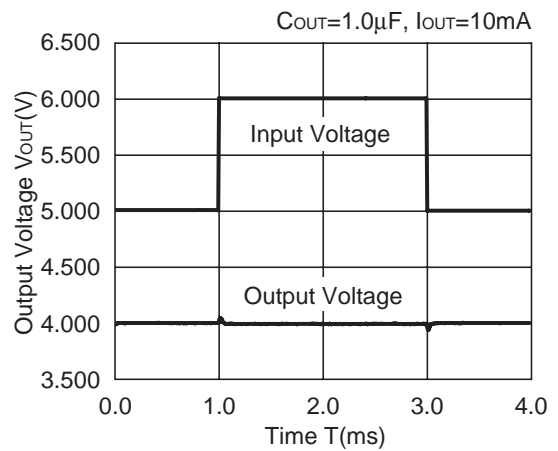

9) Load Transient Response

R1100D091C



R1100D301C

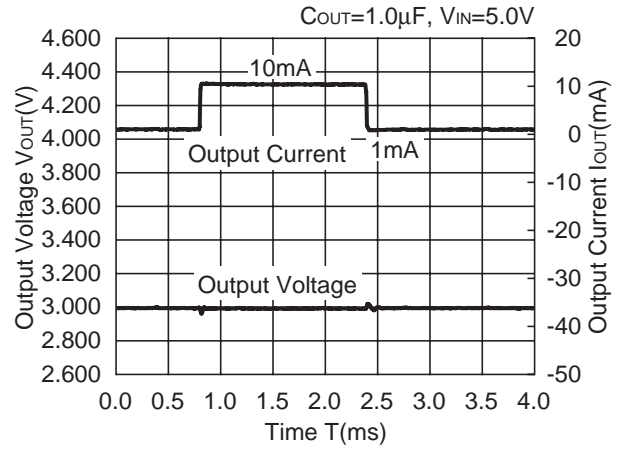

R1100D401C

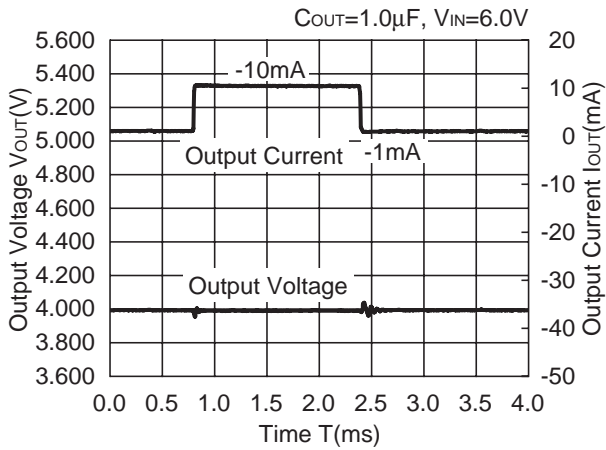

10) Ripple Rejection vs. Frequency

R1100D091C



R1100D301C



R1100D401C

$V_{IN}=5.5V_{DC}+0.5V_{p-p}$,
 $I_{OUT}=10mA$, $C_{OUT}=1\mu F$





1. The products and the product specifications described in this document are subject to change or discontinuation of production without notice for reasons such as improvement. Therefore, before deciding to use the products, please refer to Ricoh sales representatives for the latest information thereon.
2. The materials in this document may not be copied or otherwise reproduced in whole or in part without prior written consent of Ricoh.
3. Please be sure to take any necessary formalities under relevant laws or regulations before exporting or otherwise taking out of your country the products or the technical information described herein.
4. The technical information described in this document shows typical characteristics of and example application circuits for the products. The release of such information is not to be construed as a warranty of or a grant of license under Ricoh's or any third party's intellectual property rights or any other rights.
5. The products listed in this document are intended and designed for use as general electronic components in standard applications (office equipment, telecommunication equipment, measuring instruments, consumer electronic products, amusement equipment etc.). Those customers intending to use a product in an application requiring extreme quality and reliability, for example, in a highly specific application where the failure or misoperation of the product could result in human injury or death (aircraft, spacevehicle, nuclear reactor control system, traffic control system, automotive and transportation equipment, combustion equipment, safety devices, life support system etc.) should first contact us.
6. We are making our continuous effort to improve the quality and reliability of our products, but semiconductor products are likely to fail with certain probability. In order to prevent any injury to persons or damages to property resulting from such failure, customers should be careful enough to incorporate safety measures in their design, such as redundancy feature, fire containment feature and fail-safe feature. We do not assume any liability or responsibility for any loss or damage arising from misuse or inappropriate use of the products.
7. Anti-radiation design is not implemented in the products described in this document.
8. Please contact Ricoh sales representatives should you have any questions or comments concerning the products or the technical information.



Ricoh is committed to reducing the environmental loading materials in electrical devices with a view to contributing to the protection of human health and the environment.

Ricoh has been providing RoHS compliant products since April 1, 2006 and Halogen-free products since April 1, 2012.

RICOH RICOH ELECTRONIC DEVICES CO., LTD.

<http://www.e-devices.ricoh.co.jp/en/>

Sales & Support Offices

RICOH ELECTRONIC DEVICES CO., LTD.

Higashi-Shinagawa Office (International Sales)
3-32-3, Higashi-Shinagawa, Shinagawa-ku, Tokyo 140-8655, Japan
Phone: +81-3-5479-2857 Fax: +81-3-5479-0502

RICOH EUROPE (NETHERLANDS) B.V.

Semiconductor Support Centre
Prof. W.H. Keesomlaan 1, 1183 DJ Amstelveen, The Netherlands
Phone: +31-20-5474-309

RICOH ELECTRONIC DEVICES KOREA CO., LTD.

3F, Haesung Bldg. 504, Teheran-ro, Gangnam-gu, Seoul, 135-725, Korea
Phone: +82-2-2135-5700 Fax: +82-2-2051-5713

RICOH ELECTRONIC DEVICES SHANGHAI CO., LTD.

Room 403, No.2 Building, No.690 Bilbo Road, Pu Dong New District, Shanghai 201203,
People's Republic of China
Phone: +86-21-5027-3200 Fax: +86-21-5027-3299

RICOH ELECTRONIC DEVICES CO., LTD.

Taipei office
Room 109, 10F-1, No.51, Hengyang Rd., Taipei City, Taiwan (R.O.C.)
Phone: +886-2-2313-1621/1622 Fax: +886-2-2313-1623

Mouser Electronics

Authorized Distributor

Click to View Pricing, Inventory, Delivery & Lifecycle Information:

Ricoh Electronics:

[R1100D331C-TR-F](#) [R1100D101C-TR-F](#) [R1100D201C-TR-F](#) [R1100D301C-TR-F](#) [R1100D181C-TR-F](#) [R1100D121C-TR-F](#) [R1100D381C-TR-F](#) [R1100D221C-TR-F](#)



Компания «ЭлектроПласт» предлагает заключение долгосрочных отношений при поставках импортных электронных компонентов на взаимовыгодных условиях!

Наши преимущества:

- Оперативные поставки широкого спектра электронных компонентов отечественного и импортного производства напрямую от производителей и с крупнейших мировых складов;
- Поставка более 17-ти миллионов наименований электронных компонентов;
- Поставка сложных, дефицитных, либо снятых с производства позиций;
- Оперативные сроки поставки под заказ (от 5 рабочих дней);
- Экспресс доставка в любую точку России;
- Техническая поддержка проекта, помощь в подборе аналогов, поставка прототипов;
- Система менеджмента качества сертифицирована по Международному стандарту ISO 9001;
- Лицензия ФСБ на осуществление работ с использованием сведений, составляющих государственную тайну;
- Поставка специализированных компонентов (Xilinx, Altera, Analog Devices, Intersil, Interpoint, Microsemi, Aeroflex, Peregrine, Syfer, Eurofarad, Texas Instrument, Miteq, Cobham, E2V, MA-COM, Hittite, Mini-Circuits, General Dynamics и др.);

Помимо этого, одним из направлений компании «ЭлектроПласт» является направление «Источники питания». Мы предлагаем Вам помощь Конструкторского отдела:

- Подбор оптимального решения, техническое обоснование при выборе компонента;
- Подбор аналогов;
- Консультации по применению компонента;
- Поставка образцов и прототипов;
- Техническая поддержка проекта;
- Защита от снятия компонента с производства.



Как с нами связаться

Телефон: 8 (812) 309 58 32 (многоканальный)

Факс: 8 (812) 320-02-42

Электронная почта: org@eplast1.ru

Адрес: 198099, г. Санкт-Петербург, ул. Калинина, дом 2, корпус 4, литера А.