

ADG506A/ADG507A

FEATURES

- 44 V Supply Maximum Rating
- V_{SS} to V_{DD} Analog Signal Range
- Single/Dual Supply Specifications
- Wide Supply Ranges (10.8 V to 16.5 V)
- Extended Plastic Temperature Range
(-40°C to +85°C)
- Low Power Dissipation (28 mW max)
- Low Leakage (20 pA typ)
- Available in 28-Lead DIP, SOIC, PLCC, TSSOP and LCCC Packages
- Superior Alternative to:
DG506A, HI-506
DG507A, HI-507

FUNCTIONAL BLOCK DIAGRAM



GENERAL DESCRIPTION

The ADG506A and ADG507A are CMOS monolithic analog multiplexers with 16 channels and dual 8 channels, respectively. The ADG506A switches one of 16 inputs to a common output, depending on the state of four binary addresses and an enable input. The ADG507A switches one of eight differential inputs to a common differential output, depending on the state of three binary addresses and an enable input. Both devices have TTL and 5 V CMOS logic compatible digital inputs.

The ADG506A and ADG507A are designed on an enhanced LC²MOS process, which gives an increased signal capability of V_{SS} to V_{DD} and enables operation over a wide range of supply voltages. The devices can operate comfortably anywhere in the 10.8 V to 16.5 V single or dual supply range. These multiplexers also feature high switching speeds and low R_{ON} .

PRODUCT HIGHLIGHTS

1. Single/Dual Supply Specifications with a Wide Tolerance
The devices are specified in the 10.8 V to 16.5 V range for both single and dual supplies.
2. Extended Signal Range
The enhanced LC²MOS processing results in a high break-down and an increased analog signal range of V_{SS} to V_{DD} .
3. Break-Before-Make Switching
Switches are guaranteed break-before-make so input signals are protected against momentary shorting.
4. Low Leakage
Leakage currents in the range of 20 pA make these multiplexers suitable for high precision circuits.

ORDERING GUIDE

Model ¹	Temperature Range	Package Option ²
ADG506AKN	-40°C to +85°C	N-28
ADG506AKR	-40°C to +85°C	R-28
ADG506AKP	-40°C to +85°C	P-28A
ADG506ABQ	-40°C to +85°C	Q-28
ADG506ATQ	-55°C to +125°C	Q-28
ADG506ATE	-55°C to +125°C	E-28A
ADG507AKN	-40°C to +85°C	N-28
ADG507AKR	-40°C to +85°C	R-28
ADG507AKP	-40°C to +85°C	P-28A
ADG507AKRU	-40°C to +85°C	RU-28
ADG507ABQ	-40°C to +85°C	Q-28
ADG507ATQ	-55°C to +125°C	Q-28
ADG507ATE	-55°C to +125°C	E-28A

NOTES

¹To order MIL-STD-883, Class B processed parts, add /883B to part number. See Analog Devices' *Military/Aerospace Reference Manual* (1994) for military data sheet.

²E = Leadless Ceramic Chip Carrier (LCCC); N = Plastic DIP; P = Plastic Leaded Chip Carrier (PLCC); Q = Cerdip; R = 0.3" Small Outline IC (SOIC); RU = Thin Shrink Small Outline Package (TSSOP).

REV. C

Information furnished by Analog Devices is believed to be accurate and reliable. However, no responsibility is assumed by Analog Devices for its use, nor for any infringements of patents or other rights of third parties which may result from its use. No license is granted by implication or otherwise under any patent or patent rights of Analog Devices.

ADG506A/ADG507A—SPECIFICATIONS

Dual Supply ($V_{DD} = +10.8\text{ V to }+16.5\text{ V}$, $V_{SS} = -10.8\text{ V to }-16.5\text{ V}$ unless otherwise noted)

Parameter	ADG506A ADG507A K Version		ADG506A ADG507A B Version		ADG506A ADG507A T Version		Units	Comments
	+25°C	-40°C to +85°C	+25°C	-40°C to +85°C	+25°C	-55°C to +125°C		
ANALOG SWITCH								
Analog Signal Range	V_{SS} V_{DD}	V_{SS} V_{DD}	V_{SS} V_{DD}	V_{SS} V_{DD}	V_{SS} V_{DD}	V_{SS} V_{DD}	V min V max	
R_{ON}	280 450 300	V_{SS} V_{DD} 600 400	280 450 300	V_{SS} V_{DD} 600 400	280 450 300	V_{SS} V_{DD} 600 400	Ω typ Ω max Ω max	-10 V \leq $V_S \leq$ +10 V, $I_{DS} = 1\text{ mA}$; Test Circuit 1 $V_{DD} = 15\text{ V}$ ($\pm 10\%$), $V_{SS} = -15\text{ V}$ ($\pm 10\%$) $V_{DD} = 15\text{ V}$ ($\pm 5\%$), $V_{SS} = -15\text{ V}$ ($\pm 5\%$)
R_{ON} Drift	0.6		0.6		0.6		%/°C typ	-10 V \leq $V_S \leq$ +10 V, $I_{DS} = 1\text{ mA}$
R_{ON} Match	5		5		5		% typ	-10 V \leq $V_S \leq$ +10 V, $I_{DS} = 1\text{ mA}$
I_S (OFF), Off Input Leakage	0.02 1	50	0.02 1	50	0.02 1	50	nA typ nA max	$V_1 = \pm 10\text{ V}$, $V_2 = \mp 10\text{ V}$; Test Circuit 2
I_D (OFF), Off Output Leakage	0.04		0.04		0.04		nA typ	$V_1 = \pm 10\text{ V}$, $V_2 = \mp 10\text{ V}$; Test Circuit 3
ADG506A	1	200	1	200	1	200	nA max	
ADG507A	1	100	1	100	1	100	nA max	
I_D (ON), On Channel Leakage	0.04		0.04		0.04		nA typ	$V_1 = \pm 10\text{ V}$, $V_2 = \mp 10\text{ V}$; Test Circuit 4
ADG506A	1	200	1	200	1	200	nA max	
ADG507A	1	100	1	100	1	100	nA max	
I_{DIFF} , Differential Off Output Leakage (ADG507A Only)		25		25		25	nA max	$V_1 = \pm 10\text{ V}$, $V_2 = \mp 10\text{ V}$; Test Circuit 5
DIGITAL CONTROL								
V_{INH} , Input High Voltage		2.4		2.4		2.4	V min	
V_{INL} , Input Low Voltage		0.8		0.8		0.8	V max	
I_{INL} or I_{INH}		1		1		1	μA max	$V_{IN} = 0$ to V_{DD}
C_{IN} Digital Input Capacitance	8		8		8		pF max	
DYNAMIC CHARACTERISTICS								
$t_{TRANSITION}^1$	200 300	400	200 300	400	200 300	400	ns typ ns max	$V_1 = \pm 10\text{ V}$, $V_2 = +10\text{ V}$; Test Circuit 6
t_{OPEN}^1	50 25	10	50 25	10	50 25	10	ns typ ns min	Test Circuit 7
t_{ON} (EN) ¹	200 300	400	200 300	400	200 300	400	ns typ ns max	Test Circuit 8
t_{OFF} (EN) ¹	200 300	400	200 300	400	200 300	400	ns typ ns max	Test Circuit 8
OFF Isolation	68 50		68 50		68 50		dB typ dB min	$V_{EN} = 0.8\text{ V}$, $R_L = 1\text{ k}\Omega$, $C_L = 15\text{ pF}$, $V_S = 7\text{ V rms}$, $f = 100\text{ kHz}$
C_S (OFF)	5		5		5		pF typ	$V_{EN} = 0.8\text{ V}$
C_D (OFF)	44		44		44		pF typ	$V_{EN} = 0.8\text{ V}$
ADG506A	22		22		22		pF typ	
ADG507A	4		4		4		pC typ	$R_S = 0\ \Omega$, $V_S = 0\text{ V}$; Test Circuit 9
Q_{INJ} , Charge Injection								
POWER SUPPLY								
I_{DD}	0.6		0.6		0.6		mA typ	$V_{IN} = V_{INL}$ or V_{INH}
		1.5		1.5		1.5	mA max	
I_{SS}	20		20		20		μA typ	$V_{IN} = V_{IN}$ or V_{INH}
		0.2		0.2		0.2	mA max	
Power Dissipation	10		10		10		mW typ	
		28		28		28	mW max	

NOTES

¹Sample tested at +25°C to ensure compliance.

Specifications subject to change without notice.

Single Supply ($V_{DD} = +10.8\text{ V to }+16.5\text{ V}$, $V_{SS} = \text{GND} = 0\text{ V}$ unless otherwise noted)

Parameter	ADG506A ADG507A K Version		ADG506A ADG507A B Version		ADG506A ADG507A T Version		Units	Comments
	+25°C	-40°C to +85°C	+25°C	-40°C to +85°C	+25°C	-55°C to +125°C		
ANALOG SWITCH								
Analog Signal Range	V_{SS} V_{DD}	V_{SS} V_{DD}	V_{SS} V_{DD}	V_{SS} V_{DD}	V_{SS} V_{DD}	V_{SS} V_{DD}	V min V max	
R_{ON}	500	1000	500	1000	500	1000	Ω typ Ω max	$0\text{ V} \leq V_S \leq +10\text{ V}$, $I_{DS} = 0.5\text{ mA}$; Test Circuit 1
R_{ON} Drift	0.6		0.6		0.6		%/°C typ	$0\text{ V} \leq V_S \leq +10\text{ V}$, $I_{DS} = 0.5\text{ mA}$
R_{ON} Match	5		5		5		% typ	$0\text{ V} \leq V_S \leq +10\text{ V}$, $I_{DS} = 0.5\text{ mA}$
I_S (OFF), Off Input Leakage	0.02 1	50	0.02 1	50	0.02 1	50	nA typ nA max	$V_1 = +10\text{ V}/0\text{ V}$, $V_2 = 0\text{ V}/+10\text{ V}$; Test Circuit 2
I_D (OFF), Off Output Leakage	0.04 1	200	0.04 1	200	0.04 1	200	nA typ nA max	$V_1 = +10\text{ V}/0\text{ V}$, $V_2 = 0\text{ V}/+10\text{ V}$; Test Circuit 3
ADG507A	1	100	1	100	1	100	nA max	
I_D (ON), On Channel Leakage	0.04 1	200	0.04 1	200	0.04 1	200	nA typ nA max	$V_1 = +10\text{ V}/0\text{ V}$, $V_2 = 0\text{ V}/+10\text{ V}$; Test Circuit 4
ADG506A	1	100	1	100	1	100	nA max	
ADG507A	1	100	1	100	1	100	nA max	
I_{DIFF} , Differential Off Output Leakage (ADG507A Only)		25		25		25	nA max	$V_1 = +10\text{ V}/0\text{ V}$, $V_2 = 0\text{ V}/+10\text{ V}$; Test Circuit 5
DIGITAL CONTROL								
V_{INH} , Input High Voltage		2.4		2.4		2.4	V min	
V_{INL} , Input Low Voltage		0.8		0.8		0.8	V max	
I_{INL} or I_{INH}		1		1		1	μA max	$V_{IN} = 0$ to V_{DD}
C_{IN} , Digital Input Capacitance	8		8		8		pF max	
DYNAMIC CHARACTERISTICS								
$t_{TRANSITION}^1$	300		300		300		ns typ	$V_1 = +10\text{ V}/0\text{ V}$, $V_2 = +10\text{ V}$; Test Circuit 6
	450	600	450	600	450	600	ns max	
t_{OPEN}^1	50		50		50		ns typ	Test Circuit 7
	25	10	25	10	25	10	ns min	
t_{ON} (EN) ¹	250		250		250		ns typ	Test Circuit 8
	450	600	450	600	450	600	ns max	
t_{OFF} (EN) ¹	250		250		250		ns typ	Test Circuit 8
	450	600	450	600	450	600	ns max	
OFF Isolation	68 50		68 50		68 50		dB typ dB min	$V_{EN} = 0.8\text{ V}$, $R_L = 1\text{ k}\Omega$, $C_L = 15\text{ pF}$, $V_S = 3.5\text{ V rms}$, $f = 100\text{ kHz}$
C_S (OFF)	5		5		5		pF typ	$V_{EN} = 0.8\text{ V}$
C_D (OFF)								
ADG506A	44		44		44		pF typ	$V_{EN} = 0.8\text{ V}$
ADG507A	22		22		22		pF typ	
Q_{INJ} , Charge Injection	4		4		4		pC typ	$R_S = 0\text{ }\Omega$, $V_S = 0\text{ V}$; Test Circuit 9
POWER SUPPLY								
I_{DD}	0.6		0.6		0.6		mA typ	$V_{IN} = V_{INL}$ or V_{INH}
		1.5		1.5		1.5	mA max	
Power Dissipation	10		10		10		mW typ	
		25		25		25	mW max	

NOTES

¹Sample tested at +25°C to ensure compliance.

Specifications subject to change without notice.

Truth Table (ADG506A)

A3	A2	A1	A0	EN	On Switch
X	X	X	X	0	NONE
0	0	0	0	1	1
0	0	0	1	1	2
0	0	1	0	1	3
0	0	1	1	1	4
0	1	0	0	1	5
0	1	0	1	1	6
0	1	1	0	1	7
0	1	1	1	1	8
1	0	0	0	1	9
1	0	0	1	1	10
1	0	1	0	1	11
1	0	1	1	1	12
1	1	0	0	1	13
1	1	0	1	1	14
1	1	1	0	1	15
1	1	1	1	1	16

Truth Table (ADG507A)

A2	A1	A0	EN	On Switch Pair
X	X	X	0	NONE
0	0	0	1	1
0	0	1	1	2
0	1	0	1	3
0	1	1	1	4
1	0	0	1	5
1	0	1	1	6
1	1	0	1	7
1	1	1	1	8

X = Don't Care

ADG506A/ADG507A

ABSOLUTE MAXIMUM RATINGS¹

(T_A = 25°C unless otherwise noted)

V _{DD} to V _{SS}	44 V
V _{DD} to GND	25 V
V _{SS} to GND	-25 V
Analog Inputs ²	
Voltage at S, D	V _{SS} - 2 V to V _{DD}
.....	+ 2 V or
.....	20 mA, Whichever Occurs First
Continuous Current, S or D	20 mA
Pulsed Current S or D	
1 ms Duration, 10% Duty Cycle	40 mA
Digital Inputs ²	
Voltage at A, EN	V _{SS} - 4 V
.....	to V _{DD} + 4 V or
.....	20 mA, Whichever Occurs First

Power Dissipation (Any Package)

Up to +75°C	470 mW
Derates above +75°C by	6 mW/°C

Operating Temperature

Commercial (K Version)	-40°C to +85°C
Industrial (B Version)	-40°C to +85°C
Extended (T Version)	-55°C to +125°C
Storage Temperature Range	-65°C to +150°C
Lead Temperature (Soldering, 10 secs)	+300°C

NOTES

¹Stresses above those listed under Absolute Maximum Ratings may cause permanent damage to the device. This is a stress rating only; functional operation of the device at these or any other conditions above those indicated in the operational sections of this specification is not implied. Exposure to absolute maximum rating conditions for extended periods may affect device reliability.

²Overvoltage at A, EN, S or D will be clamped by diodes. Current should be limited to the Maximum Rating above.

CAUTION

ESD (electrostatic discharge) sensitive device. Electrostatic charges as high as 4000 V readily accumulate on the human body and test equipment and can discharge without detection. Although the ADG506A/ADG507A feature proprietary ESD protection circuitry, permanent damage may occur on devices subjected to high energy electrostatic discharges. Therefore, proper ESD precautions are recommended to avoid performance degradation or loss of functionality.



PIN CONFIGURATIONS

DIP, SOIC



LCCC



PLCC

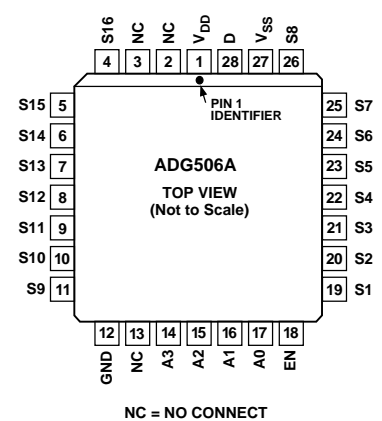

DIP, SOIC, TSSOP

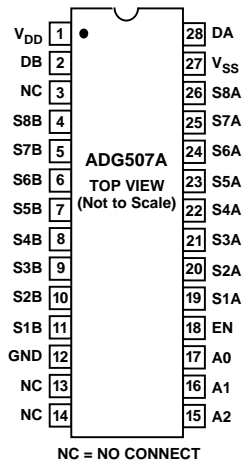

LCCC

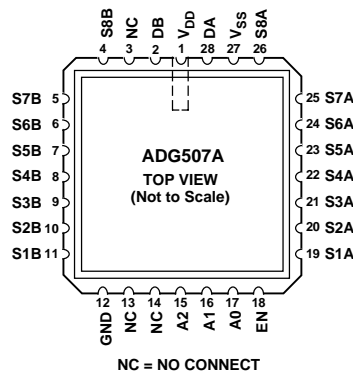

PLCC

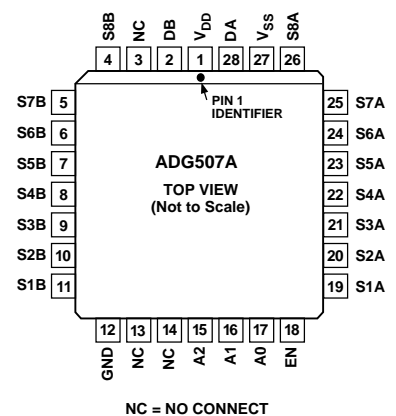

Typical Performance Characteristics—ADG506A/ADG507A

The multiplexers are guaranteed functional with reduced single or dual supplies down to 4.5 V.



Figure 1. R_{ON} as a Function of V_D (V_S): Dual Supply Voltage, $T_A = +25^\circ\text{C}$



Figure 4. R_{ON} as a Function of V_D (V_S) Single Supply Voltage, $T_A = +25^\circ\text{C}$



Figure 2. Leakage Current as a Function of Temperature (Note: Leakage Currents Reduce as the Supply Voltages Reduce)



Figure 5. Trigger Levels vs. Power Supply Voltage, Dual or Single Supply, $T_A = +25^\circ\text{C}$



Figure 3. $t_{TRANSITION}$ vs. Supply Voltage: Dual and Single Supplies, $T_A = +25^\circ\text{C}$ (Note: For V_{DD} and $V_{SS} < 10\text{ V}$; $V1 = V_{DD}/V_{SS}$, $V2 = V_{SS}/V_{DD}$. See Test Circuit 6)



Figure 6. I_{DD} vs. Supply Voltage: Dual or Single Supply, $T_A = +25^\circ\text{C}$

ADG506A/ADG507A—Test Circuits

Note: All Digital Input Signal Rise and Fall Times Measured from 10% to 90% of 3 V. $t_R = t_F = 20$ ns.



Test Circuit 1. R_{ON}



Test Circuit 2. $I_S(OFF)$



Test Circuit 3. $I_D(OFF)$



Test Circuit 4. $I_D(ON)$



$$I_{DIFF} = I_{DA(OFF)} - I_{DB(OFF)}$$

Test Circuit 5. I_{DIFF}

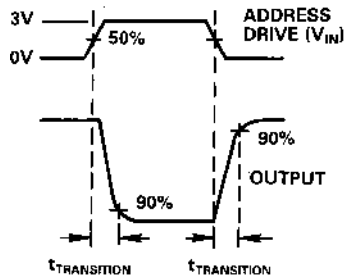

*SIMILAR CONNECTION FOR AD507A

Test Circuit 6. Switching Time of Multiplexer, $t_{TRANSITION}$

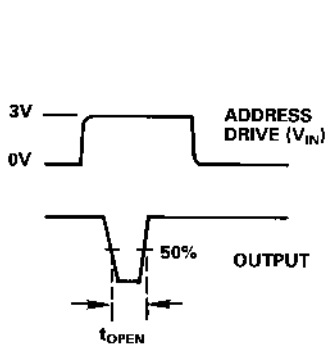
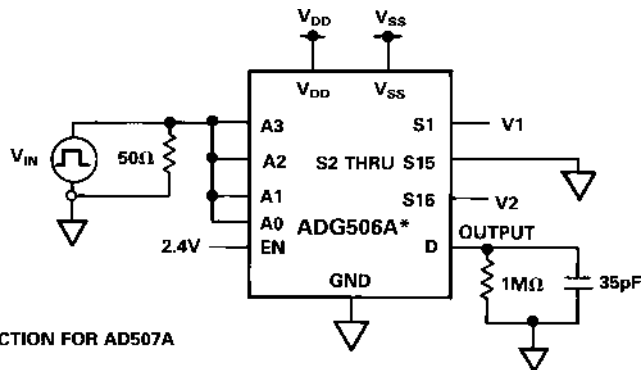

*SIMILAR CONNECTION FOR AD507A

Test Circuit 7. Break-Before-Make Delay, t_{OPEN}

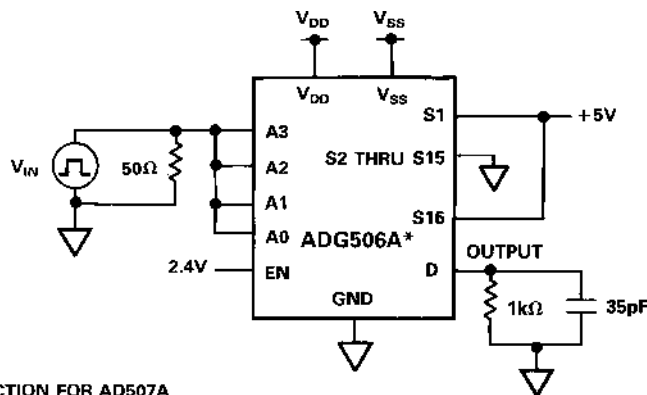



*SIMILAR CONNECTION FOR AD507A

Test Circuit 8. Enable Delay, $t_{ON}(EN)$, $t_{OFF}(EN)$

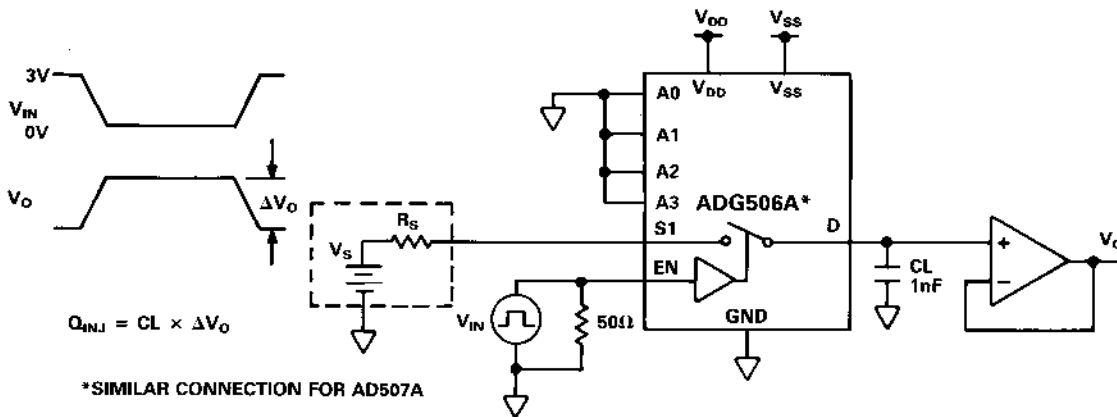

*SIMILAR CONNECTION FOR AD507A

Test Circuit 9. Charge Injection

SINGLE SUPPLY AUTOMOTIVE APPLICATION

The excellent performance of the multiplexers under single supply conditions makes the ADG506A/ADG507A suitable in applications such as automotive and disc drives where only positive power supply voltages are normally available. The following application circuit shows the ADG507A connected as an 8-channel differential multiplexer in an automotive, data acquisition application circuit.

The AD7580 is a 10-bit successive approximation ADC, which has an on-chip sample-and-hold amplifier and provides a conversion result in 20 μ s. The ADC has differential analog inputs and is configured in the application circuit for a span of 2.5 V over a common-mode range 0 V to +5 V. Wider common-mode ranges can be accommodated. See the AD7579/AD7580 data sheet for more details. The complete system operates from +12 V (+10%) and +5 V supplies. The analog input signals to the ADG507A contain information such as temperature, pressure, speed etc.



Figure 7. ADG507A in a Single Supply Automotive Data Acquisition Application

ADG506A/ADG507A

TERMINOLOGY

R_{ON}	Ohmic resistance between terminals D and S
R_{ON} Match	Difference between the R_{ON} of any two channels
R_{ON} Drift	Change in R_{ON} versus temperature
I_S (OFF)	Source terminal leakage current when the switch is off
I_D (OFF)	Drain terminal leakage current when the switch is off
I_D (ON)	Leakage current that flows from the closed switch into the body
V_S (V_D)	Analog voltage on terminal S or D
C_S (OFF)	Channel input capacitance for "OFF" condition
C_D (OFF)	Channel output capacitance for "OFF" condition
C_{IN}	Digital input capacitance
t_{ON} (EN)	Delay time between the 50% and 90% points of the digital input and switch "ON" condition

t_{OFF} (EN)	Delay time between the 50% and 10% points of the digital input and switch "OFF" condition
$t_{TRANSITION}$	Delay time between the 50% and 90% points of the digital inputs and switch "ON" condition when switching from one address state to another
t_{OPEN}	"OFF" time measured between 50% points of both switches when switching from one address state to another
V_{INL}	Maximum input voltage for Logic "0"
V_{INH}	Minimum input voltage for Logic "1"
I_{INL} (I_{INH})	Input current of the digital input
V_{DD}	Most positive voltage supply
V_{SS}	Most negative voltage supply
I_{DD}	Positive supply current
I_{SS}	Negative supply current

OUTLINE DIMENSIONS

Dimensions shown in inches and (mm).

28-Lead Plastic DIP (Suffix N)



28-Lead Cerdip (Suffix Q)



28-Lead SOIC (Suffix R)

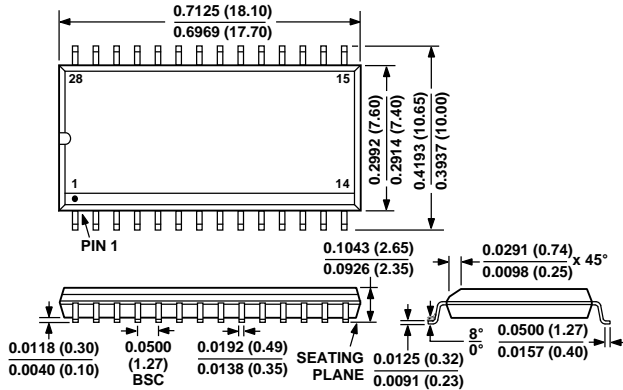

28-Lead TSSOP (Suffix RU)



28-Terminal Plastic Leaded Chip Carrier (Suffix P)



28-Terminal Leadless Ceramic Chip Carrier (Suffix E)





Компания «ЭлектроПласт» предлагает заключение долгосрочных отношений при поставках импортных электронных компонентов на взаимовыгодных условиях!

Наши преимущества:

- Оперативные поставки широкого спектра электронных компонентов отечественного и импортного производства напрямую от производителей и с крупнейших мировых складов;
- Поставка более 17-ти миллионов наименований электронных компонентов;
- Поставка сложных, дефицитных, либо снятых с производства позиций;
- Оперативные сроки поставки под заказ (от 5 рабочих дней);
- Экспресс доставка в любую точку России;
- Техническая поддержка проекта, помощь в подборе аналогов, поставка прототипов;
- Система менеджмента качества сертифицирована по Международному стандарту ISO 9001;
- Лицензия ФСБ на осуществление работ с использованием сведений, составляющих государственную тайну;
- Поставка специализированных компонентов (Xilinx, Altera, Analog Devices, Intersil, Interpoint, Microsemi, Aeroflex, Peregrine, Syfer, Eurofarad, Texas Instrument, Miteq, Cobham, E2V, MA-COM, Hittite, Mini-Circuits, General Dynamics и др.);

Помимо этого, одним из направлений компании «ЭлектроПласт» является направление «Источники питания». Мы предлагаем Вам помощь Конструкторского отдела:

- Подбор оптимального решения, техническое обоснование при выборе компонента;
- Подбор аналогов;
- Консультации по применению компонента;
- Поставка образцов и прототипов;
- Техническая поддержка проекта;
- Защита от снятия компонента с производства.



Как с нами связаться

Телефон: 8 (812) 309 58 32 (многоканальный)

Факс: 8 (812) 320-02-42

Электронная почта: org@eplast1.ru

Адрес: 198099, г. Санкт-Петербург, ул. Калинина, дом 2, корпус 4, литера А.