

TA Series



Power Chip Thick Film on Alumina Substrate

Ohmite's original Power Chip resistors feature our thick film on alumina substrate technology. These planar packages yield space saving, 10W/in² power densities that require over 50% less board space than other radial packages. Convection cooling is maximized by the planar package configuration which dissipates heat well above board level.

Ohmite's power chip resistors have a 125% higher operating temperature range than competitive product of similar design. High temperature solder and in-process plating keep terminations secure under self-heating effects by preventing re-flow from full power operation.

Flexible packaging schemes make these resistors ideal for power supplies, audio amplifiers, video fly-back, and other power control applications.



FEATURES

- High-Temp Terminal Construction
- Wide Resistance Range
- Low Inductance (50nH-100nH)
- High Power Density
- Easy to install. PC-mountable

SERIES SPECIFICATIONS

Series	Wattage	Series	Wattage	Series	Wattage	Series	Wattage	Series	Wattage
TA203	3.0	TA205	5.0	TA207	7.5	TA310	10.0	TA025	25.0
TA303	3.0	TA305	5.0	TA307	7.5	TA810	10.0	TA050	50.0
		TA605	5.0					TA100	100.0
		TA805	5.0						

CHARACTERISTICS

	Substrate	Alumina	Test Condition	
	Resistor	Thick Film	Test MILR83401	Specification
	Coating	Glass	Life (Rated Power)	40°C, rated power, 90 min ON 30 min OFF, 1000 hrs.
	Terminals	Solder Plated Phosphor Bronze	Life (Moisture Load)	60°C, 90 - 95% RH, rated power, 90 min ON 30 min OFF, 1000 hrs.
Temperature Coefficient	1 ohm:	450 ppm/°C	Temperature Cycling	Room temp > -55°C 30 min > RT 10 min ± 120°C 30 min > RT10 min 5 cycles
	1 to 100Ω:	100 ppm/°C	Flammability	UL94V-O rated (not recognized)
	101Ω and up:	50 ppm/°C	Soldering Heat	350°C Solderpot, 3 secs.
Tolerance	±1%, ±5% and ±10%		Insulation Resistance	DC 100V, 1 min
Power Rating	Based on 25°C free air			
Resistance Range	0.25 ohm to 10M ohm. Consult factory for other values			
Maximum Operating Voltage	350 VAC, 500 VDC through glass, 1000 VAC, 1500 VDC through substrate, not to exceed power rating			
Overload	Five times rated power, as long as the one second average dissipation does not exceed the wattage rating. ΔR: ±2%, 2000 hours			
Derating	100% @ 25°C to 0% @ 180°C ambient.			
Equivalent Parallel Capacitance	1.0pf (100 MHz)			
Withstanding Voltage	5000V thru back side			
Operating Temperature Range	-55°C to +180°C			
Overload Current	20 x rated current up to 8 ms (ΔR ± 0.5%)			

(continued)

rev 6/18-1

TA Series

Power Chip Thick Film on Alumina Substrate

DIMENSIONS

(±.020 in. / ±.508mm)

PA
3, 5, 7.5
& 10 watt



PW
10, 25, 50
& 100 watt

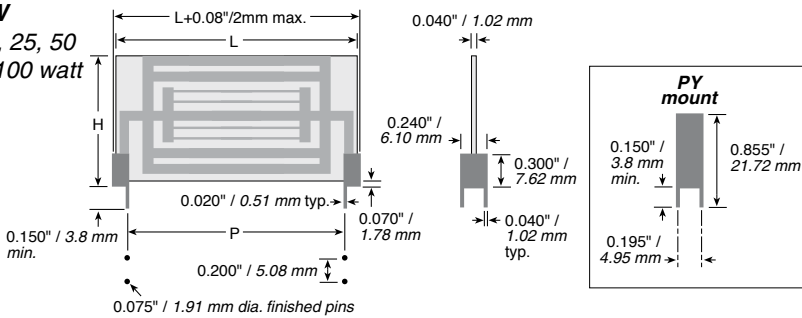

Series	Wattage	P	Length L	Height H
TA203PA	3.0	0.200 / 5.08	0.50 / 12.70	0.60 / 15.24
TA303PA	3.0	0.300 / 7.62	0.50 / 12.70	0.60 / 15.24
TA205PA	5.0	0.200 / 5.08	0.50 / 12.70	1.00 / 25.40
TA305PA	5.0	0.300 / 7.62	0.50 / 12.70	1.00 / 25.40
TA605PA	5.0	0.600 / 15.24	1.00 / 25.40	0.50 / 12.70
TA805PA	5.0	0.800 / 20.32	1.00 / 25.40	0.50 / 12.70
TA207PA	7.5	0.200 / 5.08	0.75 / 19.05	1.00 / 25.40
TA307PA	7.5	0.300 / 7.62	0.75 / 19.05	1.00 / 25.40
TA310PA	10.0	0.300 / 7.62	1.00 / 25.40	1.00 / 25.40
TA310PW*	10.0	0.300 / 7.62	1.085 / 27.56	1.00 / 25.40
TA810PA	10.0	0.800 / 20.32	1.00 / 25.40	1.00 / 25.40
TA810PW*	10.0	0.800 / 20.32	1.085 / 27.56	1.00 / 25.40
TA025PA	25.0	1.90 / 48.3	2.220 / 56.39	1.170 / 29.70
TA025PY*	25.0	1.90 / 48.3	2.220 / 56.39	1.170 / 29.70
TA050PA	50.0	1.90 / 48.3	2.220 / 56.39	2.270 / 57.60
TA050PY*	50.0	1.90 / 48.3	2.220 / 56.39	2.270 / 57.60
TA100PA	100.0	4.10 / 104.1	4.420 / 112.27	2.270 / 57.60
TA100PY*	100.0	4.10 / 104.1	4.420 / 112.27	2.270 / 57.60

*10-100 watts available in PW,PA, and PY packages.

ORDERING INFORMATION

Pin spacing (on 3-10W models only)
 2 = .2"
 3 = .3"
 8 = .8"

Tolerance
 K = 10%
 J = 5%
 F = 1%

RoHS compliant

TA 3 0 5 PA 4 K 5 0 J E

Series: TA
 Power Rating: 3 = 3 W, 05 = 5, 07 = 7.5, 10 = 10, 025 = 25, 050 = 50, 100 = 100
 Package: PA = pin terminals, std. for 3-10 W; PW = wraparound, std. for 10-100 W; PY = high-stability wraparound
 Resistance Value (Ω): R250 = 0.25, 10R0 = 10.0, 2K00 = 2,000, 45K0 = 45,000

Standard part numbers for TA series

Ohmic value	Part No. Prefix Suffix	Part Number	Ohmic value	Part No. Prefix Suffix	Part Number	Ohmic value	Part No. Prefix Suffix	Part Number
0.25	R250J	✓	50.00	50R0J	✓	2,500.00	2K50J	✓
1.00	1R00J	✓	62.00	62R0J	✓	3,000.00	3K00J	✓
1.50	1R50J	✓	68.00	68R0J	✓	4,000.00	4K00J	✓
2.00	2R00J	✓	75.00	75R0J	✓	4,700.00	4K70J	✓
4.70	4R70J	✓	100.00	100RJ	✓	5,000.00	5K00J	✓
5.00	5R00J	✓	150.00	150RJ	✓	5,100.00	5K10J	✓
5.10	5R10J	✓	200.00	200RJ	✓	7,500.00	7K50J	✓
7.50	7R50J	✓	250.00	250RJ	✓	10,000.00	10K0J	✓
8.20	8R20J	✓	270.00	270RJ	✓	15,000.00	15K0J	✓
10.00	10R0J	✓	300.00	300RJ	✓	18,000.00	18K0J	✓
11.00	11R0J	✓	470.00	470RJ	✓	20,000.00	20K0J	✓
12.00	12R0J	✓	500.00	560	✓	30,000.00	30K0J	✓
15.00	15R0J	✓	620.00	620RJ	✓	39,000.00	39K0J	✓
20.00	20R0J	✓	680.00	680RJ	✓	50,000.00	50K0J	✓
24.00	24R0J	✓	1,000.00	1K00J	✓	75,000.00	75K0J	✓
27.00	27R0J	✓	1,500.00	1K50J	✓	100,000	100KJ	✓
33.00	33R0J	✓	1,800.00	1K80J	✓	150,000	150KJ	✓
47.00	47R0J	✓	2,000.00	2K00J	✓	200,000	200KJ	✓

✓ = Stock values, + = Most popular standard values



Компания «ЭлектроПласт» предлагает заключение долгосрочных отношений при поставках импортных электронных компонентов на взаимовыгодных условиях!

Наши преимущества:

- Оперативные поставки широкого спектра электронных компонентов отечественного и импортного производства напрямую от производителей и с крупнейших мировых складов;
- Поставка более 17-ти миллионов наименований электронных компонентов;
- Поставка сложных, дефицитных, либо снятых с производства позиций;
- Оперативные сроки поставки под заказ (от 5 рабочих дней);
- Экспресс доставка в любую точку России;
- Техническая поддержка проекта, помощь в подборе аналогов, поставка прототипов;
- Система менеджмента качества сертифицирована по Международному стандарту ISO 9001;
- Лицензия ФСБ на осуществление работ с использованием сведений, составляющих государственную тайну;
- Поставка специализированных компонентов (Xilinx, Altera, Analog Devices, Intersil, Interpoint, Microsemi, Aeroflex, Peregrine, Syfer, Eurofarad, Texas Instrument, Miteq, Cobham, E2V, MA-COM, Hittite, Mini-Circuits, General Dynamics и др.);

Помимо этого, одним из направлений компании «ЭлектроПласт» является направление «Источники питания». Мы предлагаем Вам помощь Конструкторского отдела:

- Подбор оптимального решения, техническое обоснование при выборе компонента;
- Подбор аналогов;
- Консультации по применению компонента;
- Поставка образцов и прототипов;
- Техническая поддержка проекта;
- Защита от снятия компонента с производства.



Как с нами связаться

Телефон: 8 (812) 309 58 32 (многоканальный)

Факс: 8 (812) 320-02-42

Электронная почта: org@eplast1.ru

Адрес: 198099, г. Санкт-Петербург, ул. Калинина, дом 2, корпус 4, литера А.