

Glass Passivated Bridge Rectifiers

FEATURES

- Glass passivated junction
- Ideal for printed circuit board
- Reliable low cost construction
- UL Recognized File # E-326243
- Compliant to RoHS Directive 2011/65/EU and in accordance to WEEE 2002/96/EC

KBL

MECHANICAL DATA

Case: KBL

Molding compound, UL flammability classification rating 94V-0

Terminal: Matte tin plated leads, solderable per JESD22-B102

Meet JESD 201 class 1A whisker test

Polarity: Polarity as marked on the body

Weight: 5.6 g (approximately)

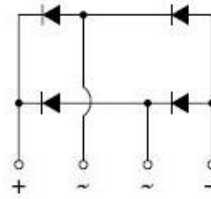

MAXIMUM RATINGS AND ELECTRICAL CHARACTERISTICS ($T_A=25^{\circ}\text{C}$ unless otherwise noted)

PARAMETER	SYMBOL	KBL 401G	KBL 402G	KBL 403G	KBL 404G	KBL 405G	KBL 406G	KBL 407G	Unit
Maximum repetitive peak reverse voltage	V_{RRM}	50	100	200	400	600	800	1000	V
Maximum RMS voltage	V_{RMS}	35	70	140	280	420	560	700	V
Maximum DC blocking voltage	V_{DC}	50	100	200	400	600	800	1000	V
Maximum average forward rectified current	$I_{F(AV)}$	4							A
Peak forward surge current, 8.3 ms single half sine-wave superimposed on rated load	I_{FSM}	150							A
Rating for fusing ($t < 8.3\text{ms}$)	I^2t	93							A^2s
Maximum instantaneous forward voltage (Note 1) $I_F = 2\text{A}$ $I_F = 4\text{A}$	V_F	1.0 1.1							V
Maximum DC reverse current at rated DC blocking voltage $T_J = 25^{\circ}\text{C}$ $T_J = 125^{\circ}\text{C}$	I_R	10 500							μA
Typical thermal resistance	$R_{\theta JL}$ $R_{\theta JA}$	2.4 19							$^{\circ}\text{C/W}$
Operating junction temperature range	T_J	- 55 to +150							$^{\circ}\text{C}$
Storage temperature range	T_{STG}	- 55 to +150							$^{\circ}\text{C}$

Note 1: Pulse Test with $PW=300\mu\text{s}$, 1% Duty Cycle

ORDERING INFORMATION

ORDERING CODE	PACKAGE	PACKING
KBL401G T0	KBL	500 / Trays
KBL402G T0	KBL	500 / Trays
KBL403G T0	KBL	500 / Trays
KBL404G T0	KBL	500 / Trays
KBL405G T0	KBL	500 / Trays
KBL406G T0	KBL	500 / Trays
KBL407G T0	KBL	500 / Trays

RATINGS AND CHARACTERISTICS CURVES

(TA=25°C unless otherwise noted)

FIG.1 FORWARD CURRENT DERATING CURVE

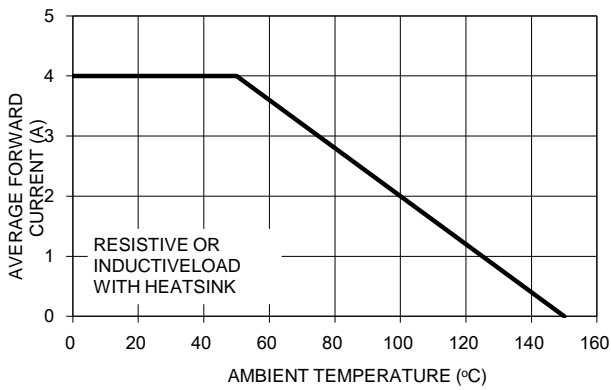

FIG. 2 TYPICAL REVERSE CHARACTERISTICS

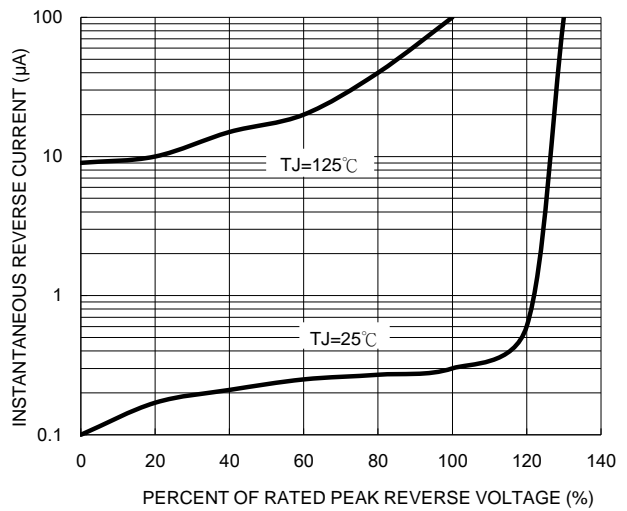

FIG. 3 MAXIMUM NON-REPETITIVE FORWARD SURGE CURRENT

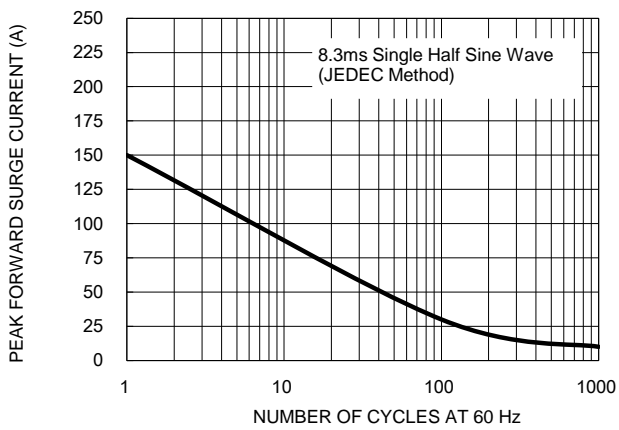

FIG. 4 TYPICAL FORWARD CHARACTERISTICS

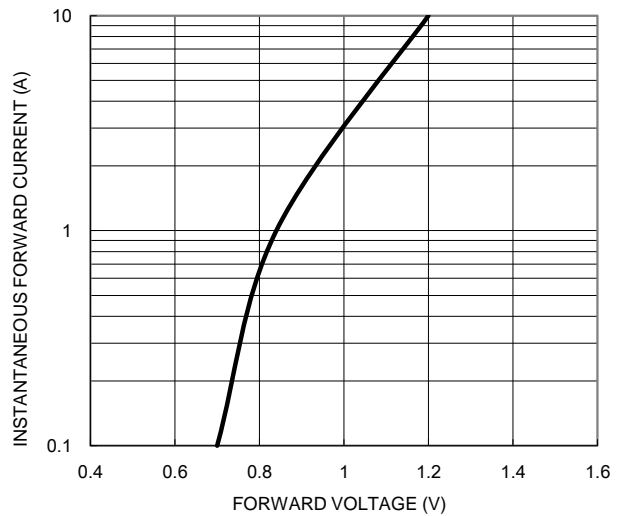
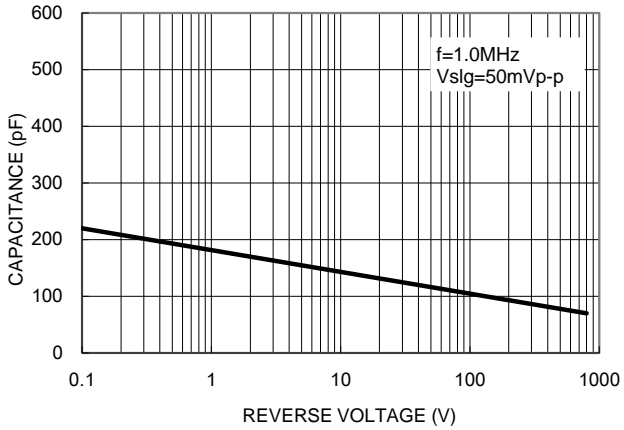
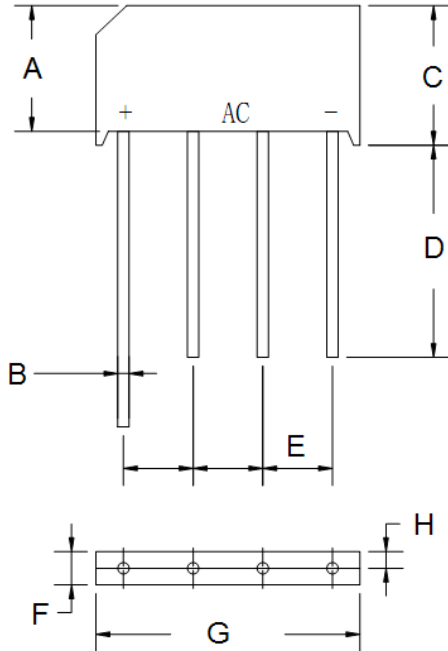

FIG. 5 TYPICAL JUNCTION CAPACITANCE



PACKAGE OUTLINE DIMENSIONS



DIM.	Unit (mm)		Unit (inch)	
	Min	Max	Min	Max
A	13.70	14.70	0.539	0.579
B	1.20	1.30	0.047	0.051
C	15.20	16.30	0.598	0.642
D	19.00	-	0.748	-
E	4.60	5.60	0.181	0.220
F	5.50	6.50	0.217	0.256
G	18.50	19.50	0.728	0.768
H	2.1 (TYP)		0.083 (TYP)	

MARKING DIAGRAM

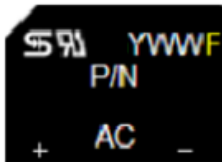

- P/N = Specific Device Code
- YWWF = Date Code
- F = Factory Code

Notice

Specifications of the products displayed herein are subject to change without notice. TSC or anyone on its behalf, assumes no responsibility or liability for any errors inaccuracies.

Information contained herein is intended to provide a product description only. No license, express or implied, to any intellectual property rights is granted by this document. Except as provided in TSC's terms and conditions of sale for such products, TSC assumes no liability whatsoever, and disclaims any express or implied warranty, relating to sale and/or use of TSC products including liability or warranties relating to fitness for a particular purpose, merchantability, or infringement of any patent, copyright, or other intellectual property right.

The products shown herein are not designed for use in medical, life-saving, or life-sustaining applications. Customers using or selling these products for use in such applications do so at their own risk and agree to fully indemnify TSC for any damages resulting from such improper use or sale.



Компания «ЭлектроПласт» предлагает заключение долгосрочных отношений при поставках импортных электронных компонентов на взаимовыгодных условиях!

Наши преимущества:

- Оперативные поставки широкого спектра электронных компонентов отечественного и импортного производства напрямую от производителей и с крупнейших мировых складов;
- Поставка более 17-ти миллионов наименований электронных компонентов;
- Поставка сложных, дефицитных, либо снятых с производства позиций;
- Оперативные сроки поставки под заказ (от 5 рабочих дней);
- Экспресс доставка в любую точку России;
- Техническая поддержка проекта, помощь в подборе аналогов, поставка прототипов;
- Система менеджмента качества сертифицирована по Международному стандарту ISO 9001;
- Лицензия ФСБ на осуществление работ с использованием сведений, составляющих государственную тайну;
- Поставка специализированных компонентов (Xilinx, Altera, Analog Devices, Intersil, Interpoint, Microsemi, Aeroflex, Peregrine, Syfer, Eurofarad, Texas Instrument, Miteq, Cobham, E2V, MA-COM, Hittite, Mini-Circuits, General Dynamics и др.);

Помимо этого, одним из направлений компании «ЭлектроПласт» является направление «Источники питания». Мы предлагаем Вам помощь Конструкторского отдела:

- Подбор оптимального решения, техническое обоснование при выборе компонента;
- Подбор аналогов;
- Консультации по применению компонента;
- Поставка образцов и прототипов;
- Техническая поддержка проекта;
- Защита от снятия компонента с производства.



Как с нами связаться

Телефон: 8 (812) 309 58 32 (многоканальный)

Факс: 8 (812) 320-02-42

Электронная почта: org@eplast1.ru

Адрес: 198099, г. Санкт-Петербург, ул. Калинина, дом 2, корпус 4, литера А.