

14V, 10nV/ $\sqrt{\text{Hz}}$, 300 $\mu\text{A}/\text{ch}$, Rail-to-Rail Input/Output Operational Amplifier

FEATURES ($V^+=5\text{V}$, $V^-=0\text{V}$, $T_a=25^\circ\text{C}$)

- Wide Supply Voltage Range
 - Single Supply 1.8V to 14V
 - Dual Supply $\pm 0.9\text{V}$ to $\pm 7\text{V}$
 - Low Noise 10nV/ $\sqrt{\text{Hz}}$ at 1kHz
 - Low Supply Current
 - NJM8530 320 $\mu\text{A}/\text{ch}$ typ.
 - NJM8532 290 $\mu\text{A}/\text{ch}$ typ.
 - NJM8534 300 $\mu\text{A}/\text{ch}$ typ.
 - Rail-to-Rail Input/Output
 - Wide Bandwidth 1MHz
 - Slew Rate 0.4V/ μs
 - Capacitive Load Drive 1000pF
 - Unity Gain Stable
 - Package
 - NJM8530 SOT-23-5
 - NJM8532 DMP8, SSOP8
 - NJM8534 MSOP8(TVSP8)*
- *meet JEDEC MO-187-DA / thin type

DESCRIPTION

The NJM8530/NJM8532/NJM8534 are single, dual and quad rail to rail input and output single supply operational amplifier featuring 14V supply voltage, low noise and low power.

A wide supply voltage range from 1.8V to 14V with a rail to rail input and output allows the device to be used in wide variety of applications, such as audio amplifier, high-side current sensing, buffering and others. Furthermore, low supply current of 290 μA typical per amplifier combined with a wide bandwidth of 1MHz and low very low noise of 10nV/ $\sqrt{\text{Hz}}$ at 1kHz make them very suitable for a variety of battery-powered applications that require a good balance between low power, low noise and wide bandwidth.

The NJM8530/NJM8532/NJM8534 can drive up to approximately 1000pF, and is unity-gain stable. Operating temperature range is -40°C to 125°C .

The NJM8530(Single) is available in 5-pin SOT-23 package. The NJM8532(Dual) is available in 8-pin DMP, SSOP and MSOP(TVSP): meet JEDEC MO-187-DA / thin type package. The NJM8534(Quad) is available in 14-pin SSOP package.

APPLICATIONS

- Battery-powered instruments
 - Audio, Sensor applications, Medical, Security
- High-side/Low-side Current sensing amplifiers
- Active Filters
- Analog-to-digital / Digital-to-analog Buffers
- Handheld Test Equipment

Rail-to-Rail Input/Output Op-Amp (Bipolar)

Supply Voltage	6V	14V
Single	NJM2730	NJM8530
Dual	NJM2732	NJM8532
Quad	NJM2734	NJM8534

PIN CONFIGURATION / PRODUCT INFORMATION

Pin Function					
Package					
Product Name	NJM8530F	NJM8532M	NJM8532V	NJM8532RB1	NJM8534V

BLOCK DIAGRAM

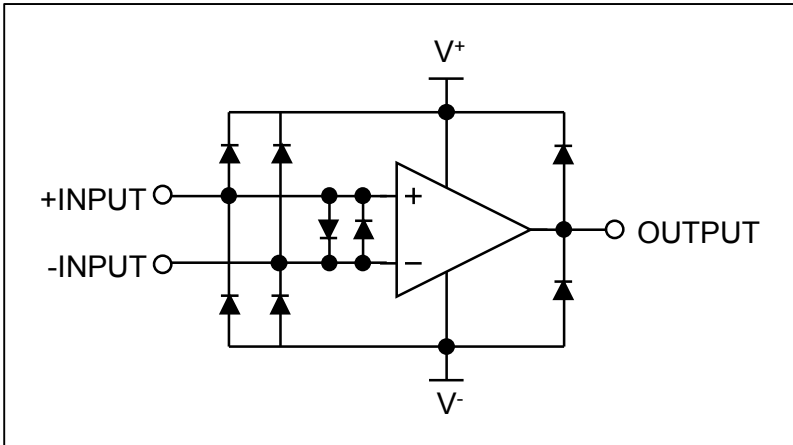

■ ABSOLUTE MAXIMUM RATINGS (Ta=25°C)

PARAMETER	SYMBOL	RATING	UNIT
Supply Voltage	V ⁺ -V ⁻	15	V
Input Voltage	V _{IN}	V ⁻ -0.3 to V ⁺ +0.3 ⁽²⁾	V
Differential Input Voltage	V _{ID}	±1.0 ⁽¹⁾⁽²⁾	V
Input Current	I _{IN}	2 ⁽²⁾	mA
Power Dissipation ⁽³⁾ SOT-23-5 DMP8 SSOP8 MSOP8(TVSP8) SSOP14	P _D	2-layer / 4-layer ⁽⁴⁾ 480 / 650 470 / 600 430 / 540 510 / 680 500 / 620	mW
Operating Temperature Range	T _{opr}	-40 to +125	°C
Storage Temperature Range	T _{stg}	-40 to +150	°C

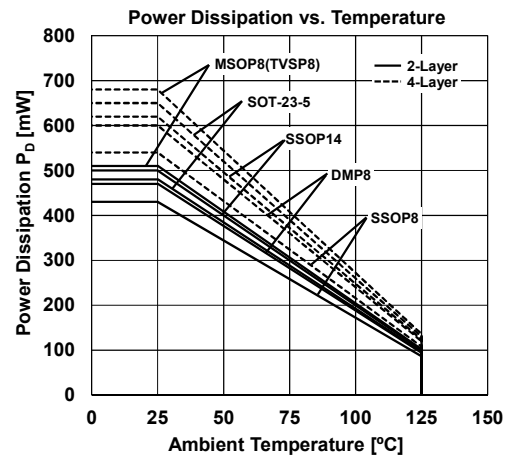

(1) Differential voltage is the voltage difference between +INPUT and -INPUT.

(2) The inputs are protected by diodes. If the differential input voltage exceeds 1.0V, the input current must be limited 2 mA or less by using a restriction resistance.

Input voltages outside the supply voltage will be clamped by ESD protection diodes. If the input voltage exceeds the supply voltage, the input current must be limited 2 mA or less by using a restriction resistance.

(3) Power dissipation is the power that can be consumed by the IC at Ta=25°C, and is the typical measured value based on JEDEC condition. When using the IC over Ta=25°C subtract the value [mW/°C]=P_D/(T_{stg}(MAX)-25) per temperature.

(4) 2-layer: EIA/JEDEC STANDARD Test board (76.2x114.3x1.6mm, 2-layers, FR-4) mounting
4-layer: EIA/JEDEC STANDARD Test board (76.2x114.3x1.6mm, 4-layers, FR-4) mounting

■ RECOMMENDED OPERATING CONDITIONS (Ta=25°C)

PARAMETER	SYMBOL	CONDITION	MIN.	TYP.	MAX.	UNIT
Supply Voltage	V ⁺ -V ⁻	Single Supply	1.8		14	V
	V ⁺ /V ⁻	Dual Supply	±0.9		±7	V

■ **ELECTRICAL CHARACTERISTICS** ($V^+=5V$, $V^-=0V$, $V_{COM}=2.5V$, $T_a=25^\circ C$, unless otherwise noted.)

PARAMETER	SYMBOL	TEST CONDITION	MIN.	TYP.	MAX.	UNIT
INPUT CHARACTERISTICS						
Input Offset Voltage	V_{IO}		-	1	4	mV
Input Offset Voltage Drift	$\Delta V_{IO}/\Delta T$	$T_a=-40^\circ C$ to $+125^\circ C$	-	1.5	-	$\mu V/^\circ C$
Input Bias Current	I_B		-	50	250	nA
Input Offset Current	I_{IO}		-	5	100	nA
Open-Loop Voltage Gain	A_V	$R_L=2k\Omega$ to 2.5V	60	85	-	dB
Common-Mode Rejection Ratio	CMR	⁽⁵⁾	55	70	-	dB
Common-Mode Input Voltage Range	V_{ICM}	CMR \geq 55dB	0	-	5	V
OUTPUT CHARACTERISTICS						
High-level Output Voltage	V_{OH}	$R_L=20k\Omega$ to 2.5V	4.9	4.95	-	V
		$R_L=2k\Omega$ to 2.5V	4.75	4.85	-	V
Low-level Output Voltage	V_{OL}	$R_L=20k\Omega$ to 2.5V	-	0.05	0.1	V
		$R_L=2k\Omega$ to 2.5V	-	0.15	0.25	V
Short-Circuit Output Current	I_{SC}	Sourcing	-	20	-	mA
		Sinking	-	5	-	mA
POWER SUPPLY						
Supply Current (All Amplifiers)	I_{SUPPLY}	No Signal	-	320	550	μA
NJM8530						
NJM8532						
NJM8534						
Supply Voltage Rejection Ratio	SVR	$V^+=4V$ to 6V	70	85	-	dB
AC CHARACTERISTICS						
Slew Rate	SR	$R_L=2k\Omega$ to 2.5V	-	0.4	-	V/ μs
Gain Bandwidth Product	GBW	$R_L=2k\Omega$ to 2.5V	-	1	-	MHz
Phase Margin	Φ_m	$R_L=2k\Omega$ to 2.5V	-	75	-	Deg
Equivalent Input Noise Voltage	e_n	$f=1kHz$	-	10	-	nV/ \sqrt{Hz}
Channel Separation	CS	$f=1kHz$, $V_o=1.2V_{rms}$	-	-133	-	dB
NJM8532/NJM8534						

(5) CMR specified is the lower of the CMR+ and CMR-.

CMR+ measured with $V^+/2 \leq V_{CM} \leq V^+$, and CMR- measured with $V^- \leq V_{CM} \leq V^+/2$.

■ ELECTRICAL CHARACTERISTICS ($V^+=3V$, $V^-=0V$, $V_{COM}=1.5V$, $T_a=25^\circ C$, unless otherwise noted.)

PARAMETER	SYMBOL	TEST CONDITION	MIN.	TYP.	MAX.	UNIT
INPUT CHARACTERISTICS						
Input Offset Voltage	V_{IO}		-	1	4	mV
Input Offset Voltage Drift	$\Delta V_{IO}/\Delta T$	$T_a=-40^\circ C$ to $+125^\circ C$	-	1.8	-	$\mu V/^\circ C$
Input Bias Current	I_B		-	50	250	nA
Input Offset Current	I_{IO}		-	5	100	nA
Open-Loop Voltage Gain	A_V	$R_L=2k\Omega$ to 1.5V	60	84	-	dB
Common-Mode Rejection Ratio	CMR	⁽⁵⁾	48	63	-	dB
Common-Mode Input Voltage Range	V_{ICM}	CMR \geq 48dB	0	-	3	V
OUTPUT CHARACTERISTICS						
High-level Output Voltage	V_{OH}	$R_L=20k\Omega$ to 1.5V	2.9	2.95	-	V
		$R_L=2k\Omega$ to 1.5V	2.75	2.85	-	V
Low-level Output Voltage	V_{OL}	$R_L=20k\Omega$ to 1.5V	-	0.05	0.1	V
		$R_L=2k\Omega$ to 1.5V	-	0.15	0.25	V
Short-Circuit Output Current	I_{SC}	Sourcing	-	18	-	mA
		Sinking	-	4.8	-	mA
POWER SUPPLY						
Supply Current (All Amplifiers)	I_{SUPPLY}	No Signal				
NJM8530			-	270	460	μA
NJM8532			-	510	880	μA
NJM8534			-	1000	1800	μA
Supply Voltage Rejection Ratio	SVR	$V^+=2.4V$ to 4V	68	83	-	dB
AC CHARACTERISTICS						
Slew Rate	SR	$R_L=2k\Omega$ to 1.5V	-	0.35	-	V/ μs
Gain Bandwidth Product	GBW	$R_L=2k\Omega$ to 1.5V	-	1	-	MHz
Phase Margin	Φ_m	$R_L=2k\Omega$ to 1.5V	-	75	-	Deg
Equivalent Input Noise Voltage	e_n	$f=1kHz$	-	10	-	nV/ \sqrt{Hz}
Channel Separation	CS	$f=1kHz$, $V_o=0.7V_{rms}$				
NJM8532/NJM8534			-	-130	-	dB

(5) CMR specified is the lower of the CMR+ and CMR-.

CMR+ measured with $V^+/2 \leq V_{CM} \leq V^+$, and CMR- measured with $V^- \leq V_{CM} \leq V^+/2$.

■ ELECTRICAL CHARACTERISTICS ($V^+=1.8V$, $V^-=0V$, $V_{COM}=0.9V$, $T_a=25^\circ C$, unless otherwise noted.)

PARAMETER	SYMBOL	TEST CONDITION	MIN.	TYP.	MAX.	UNIT
INPUT CHARACTERISTICS						
Input Offset Voltage	V_{IO}		-	1	4	mV
Input Offset Voltage Drift	$\Delta V_{IO}/\Delta T$	$T_a=-40^\circ C$ to $+125^\circ C$	-	2.4	-	$\mu V/^\circ C$
Input Bias Current	I_B		-	50	250	nA
Input Offset Current	I_{IO}		-	5	100	nA
Open-Loop Voltage Gain	A_V	$R_L=2k\Omega$ to $0.9V$	60	83	-	dB
Common-Mode Rejection Ratio	CMR	⁽⁵⁾	40	55	-	dB
Common-Mode Input Voltage Range	V_{ICM}	CMR \geq 40dB	0	-	1.8	V
OUTPUT CHARACTERISTICS						
High-level Output Voltage	V_{OH}	$R_L=20k\Omega$ to $0.9V$	1.7	1.75	-	V
		$R_L=2k\Omega$ to $0.9V$	1.55	1.65	-	V
Low-level Output Voltage	V_{OL}	$R_L=20k\Omega$ to $0.9V$	-	0.05	0.1	V
		$R_L=2k\Omega$ to $0.9V$	-	0.15	0.25	V
Short-Circuit Output Current	I_{SC}	Sourcing	-	18	-	mA
		Sinking	-	4.7	-	mA
POWER SUPPLY						
Supply Current (All Amplifiers)	I_{SUPPLY}	No Signal				
NJM8530			-	240	430	μA
NJM8532			-	460	800	μA
NJM8534			-	900	1600	μA
Supply Voltage Rejection Ratio	SVR	$V^+=1.8V$ to $2.4V$	65	80	-	dB
AC CHARACTERISTICS						
Slew Rate	SR	$R_L=2k\Omega$ to $0.9V$	-	0.3	-	V/ μs
Gain Bandwidth Product	GBW	$R_L=2k\Omega$ to $0.9V$	-	1	-	MHz
Phase Margin	Φ_m	$R_L=2k\Omega$ to $0.9V$	-	75	-	Deg
Equivalent Input Noise Voltage	e_n	$f=1kHz$	-	10	-	nV/ \sqrt{Hz}
Channel Separation	CS	$f=1kHz$, $V_o=0.4V_{rms}$				
NJM8532/NJM8534			-	-125	-	dB

(5) CMR specified is the lower of the CMR+ and CMR-.

CMR+ measured with $V^+/2 \leq V_{CM} \leq V^+$, and CMR- measured with $V^- \leq V_{CM} \leq V^+/2$.

■ TYPICAL CHARACTERISTICS ($V^- = 0V$, $T_a = 25^\circ C$, unless otherwise noted.)

Supply Current per Amplifier vs. Supply Voltage
 $G_v = 0dB$

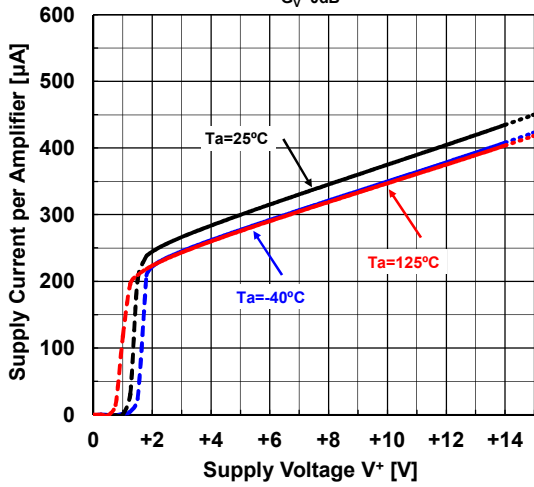

Supply Current per Amplifier vs. Temperature
 $G_v = 0dB$

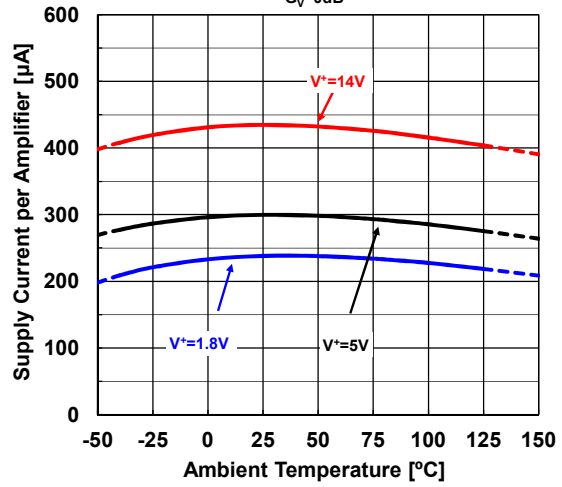

Input Offset Voltage vs. Supply Voltage
 $V_{COM} = V^+/2$

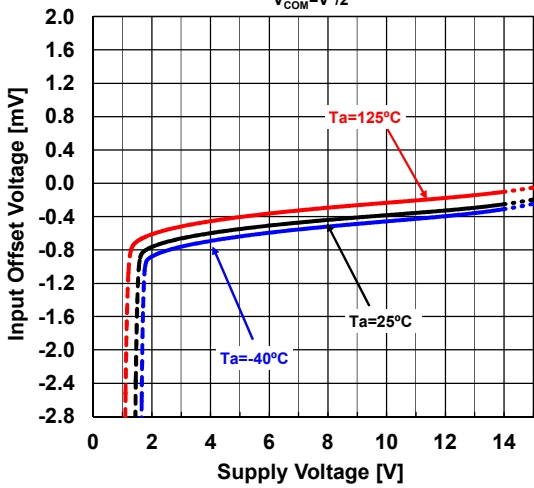

Input Offset Voltage vs. Temperature
 $V_{COM} = V^+/2$

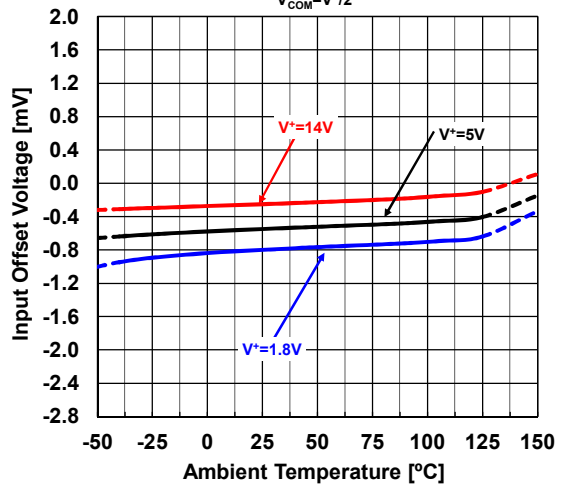

Input Offset Voltage Distribution
 $V^+ = 14V, V_{COM} = V^+/2, T_a = 25^\circ C$

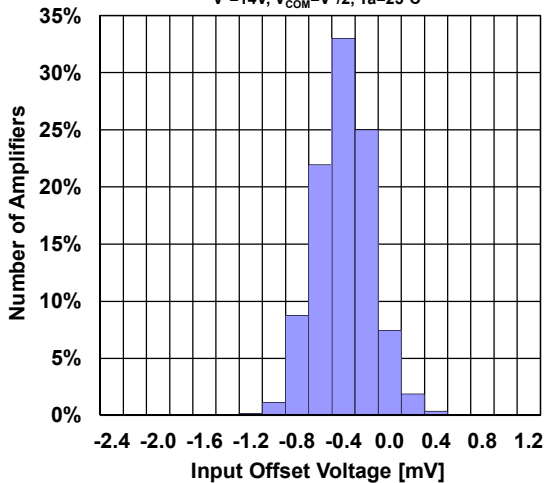

Input Offset Voltage Distribution
 $V^+ = 5V, V_{COM} = V^+/2, T_a = 25^\circ C$

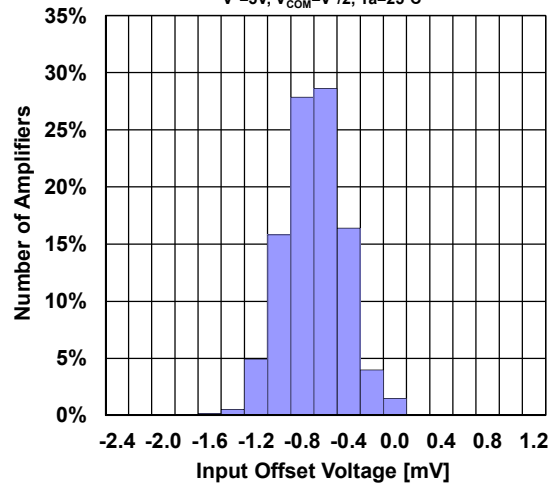

■ TYPICAL CHARACTERISTICS ($V^- = 0V$, $T_a = 25^\circ C$, unless otherwise noted.)

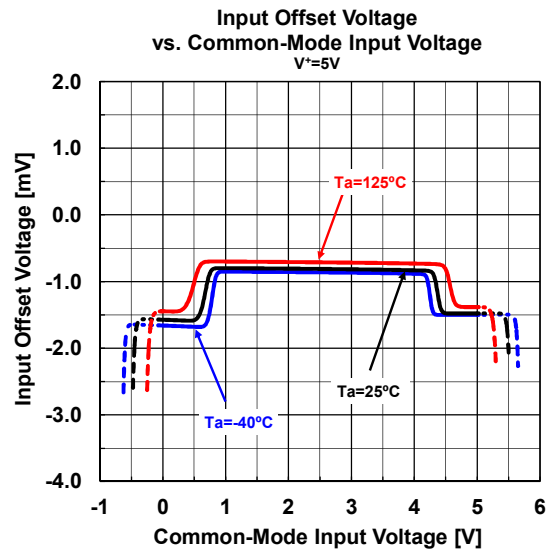
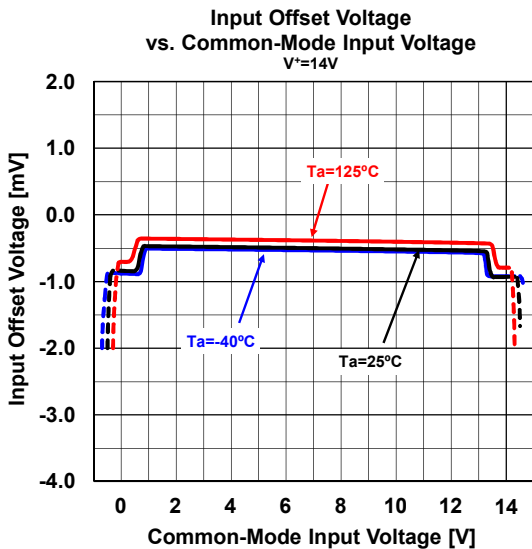
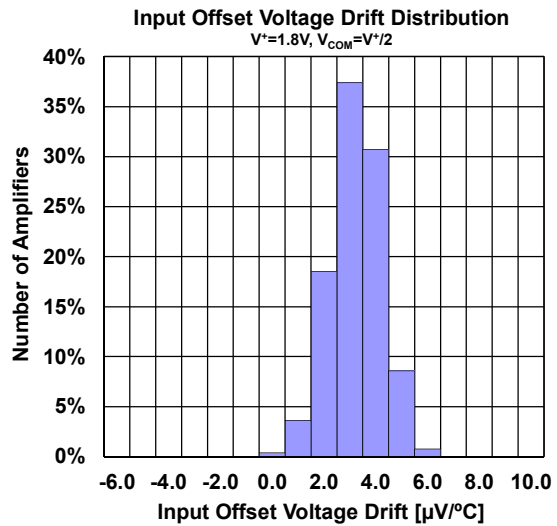
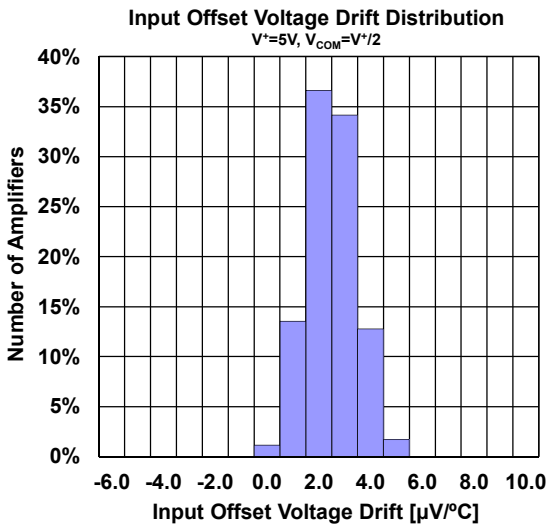
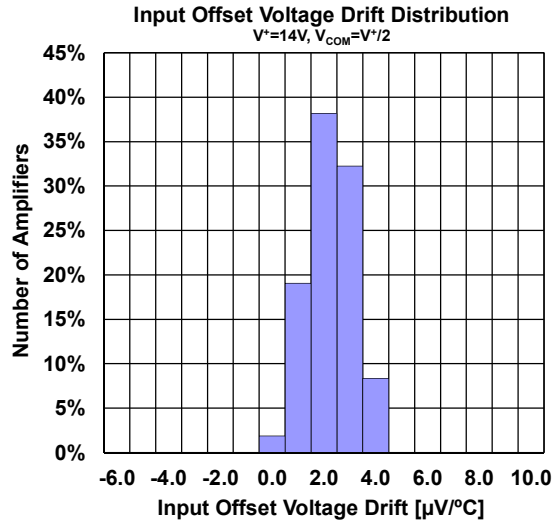
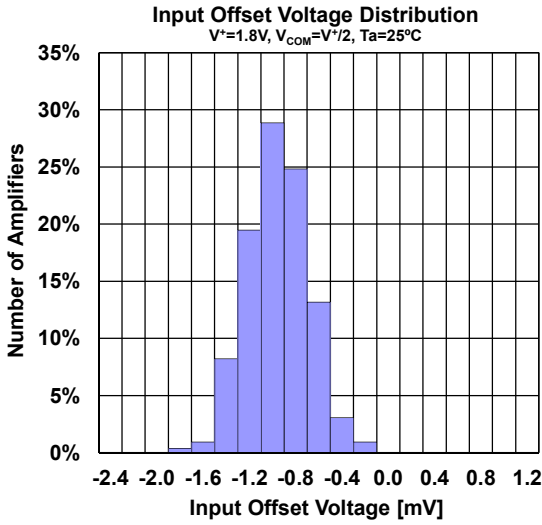

■ TYPICAL CHARACTERISTICS ($V^- = 0V$, $T_a = 25^\circ C$, unless otherwise noted.)

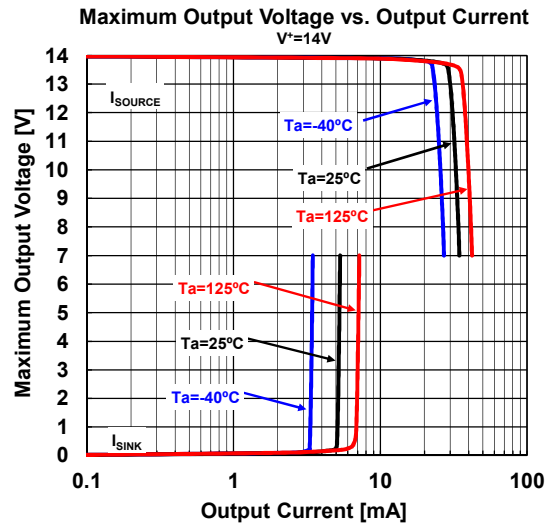
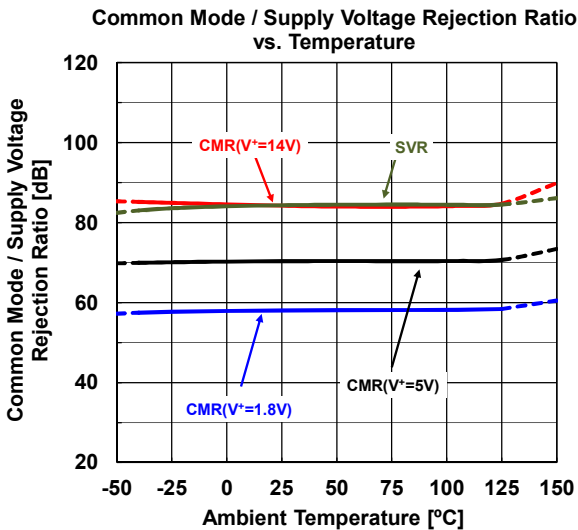
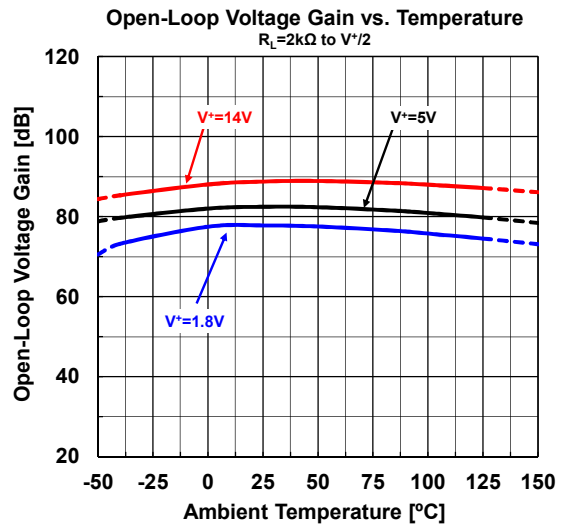
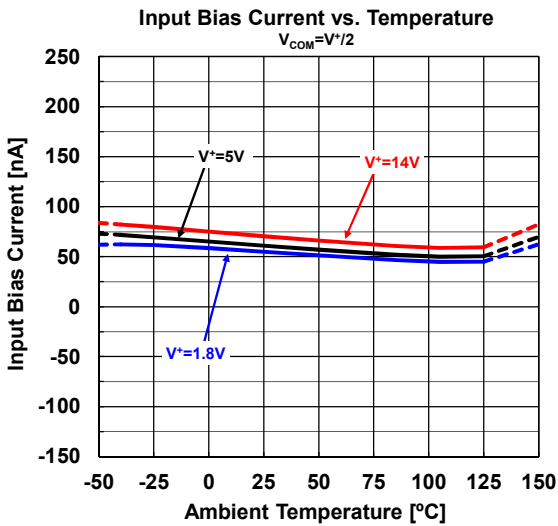
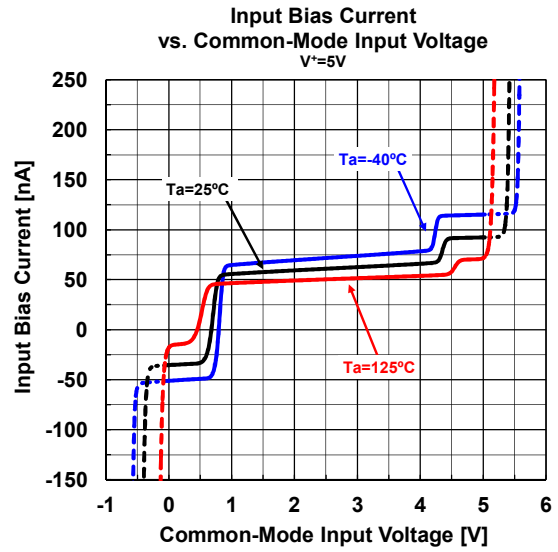
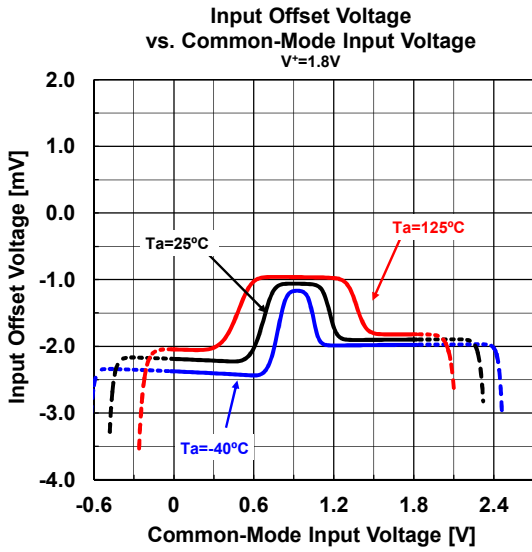

■ TYPICAL CHARACTERISTICS ($V^- = 0V$, $T_a = 25^\circ C$, unless otherwise noted.)

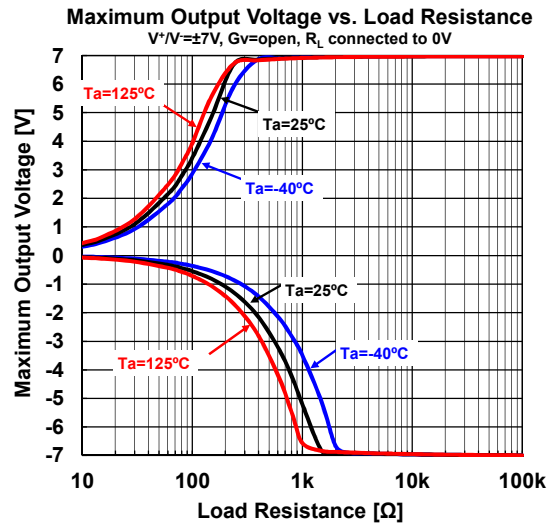
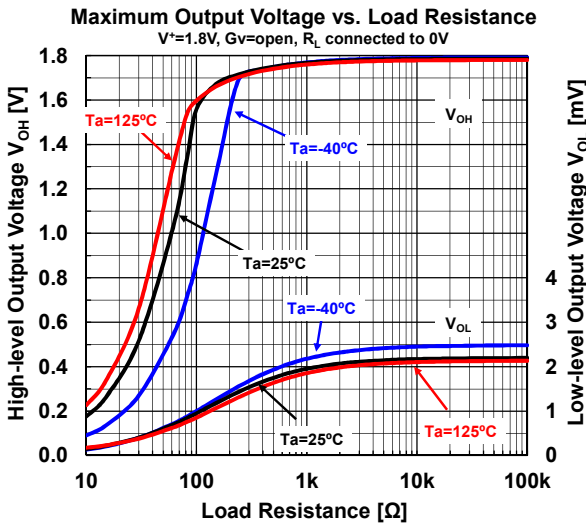
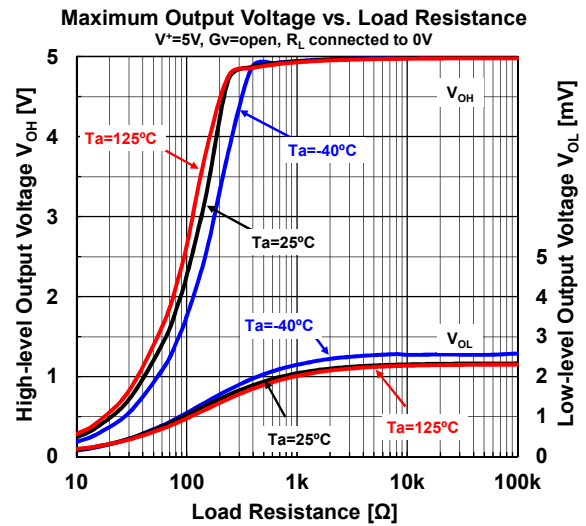
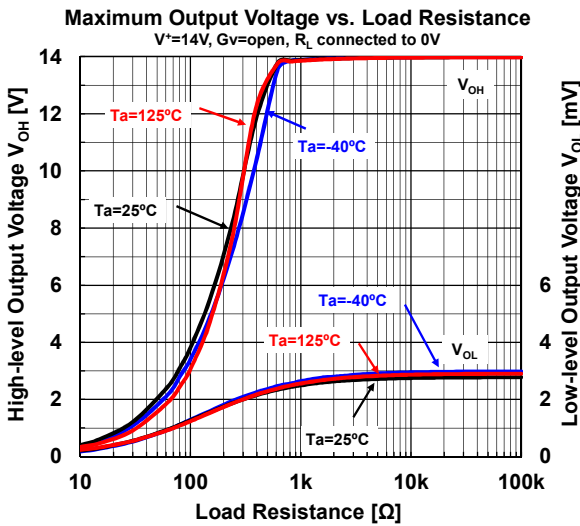
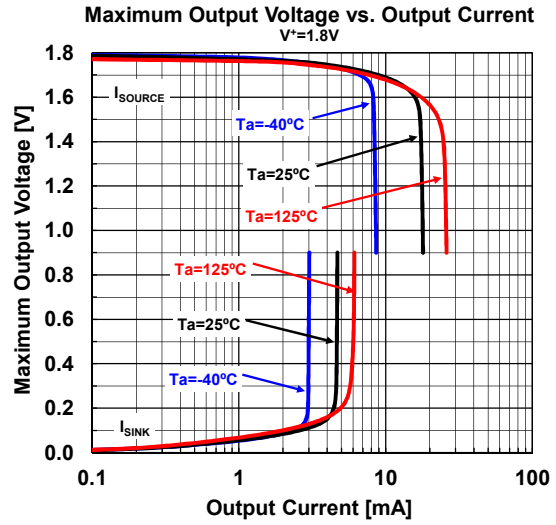
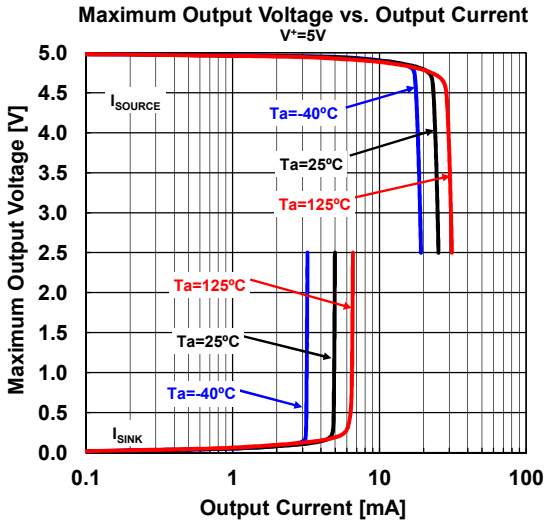

■ TYPICAL CHARACTERISTICS ($V^- = 0V$, $T_a = 25^\circ C$, unless otherwise noted.)

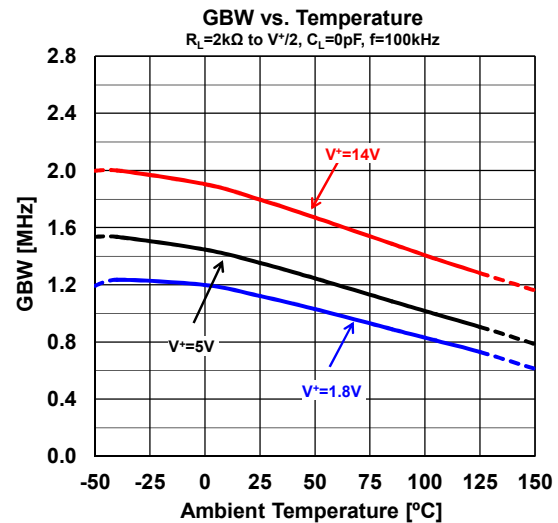
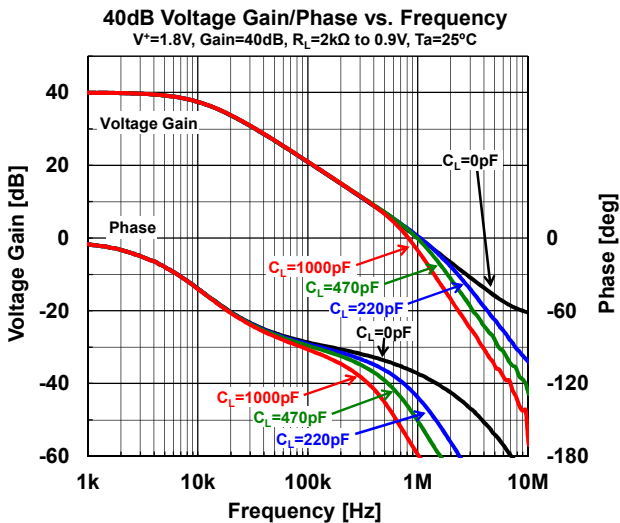
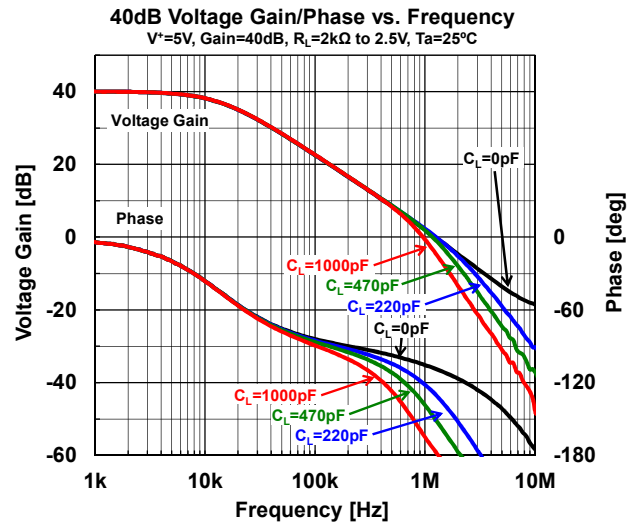
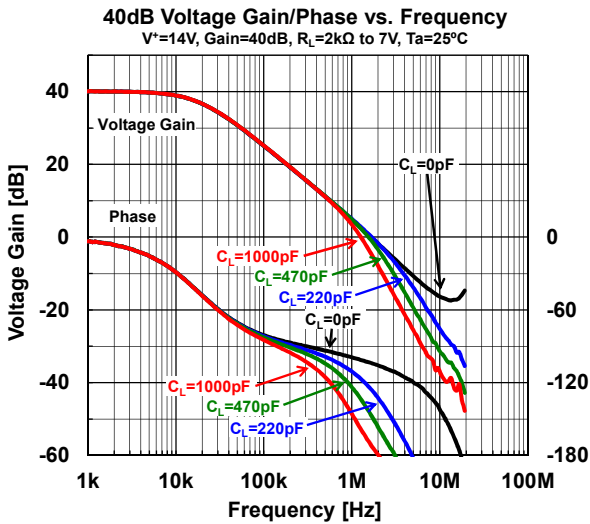
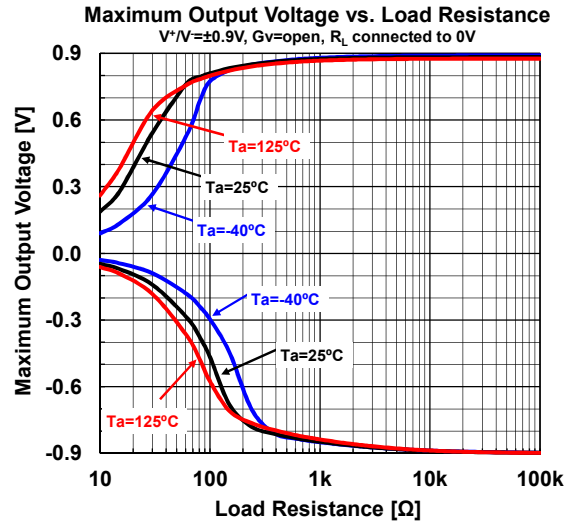
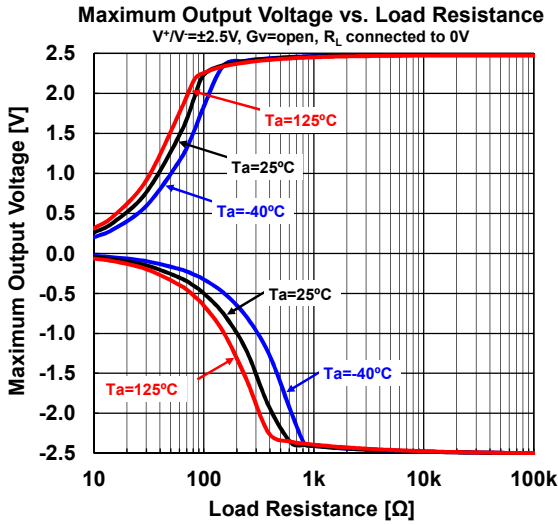

■ TYPICAL CHARACTERISTICS ($V^- = 0V$, $T_a = 25^\circ C$, unless otherwise noted.)

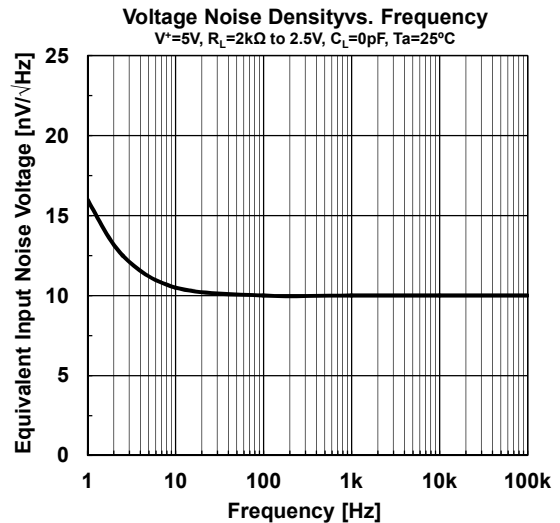
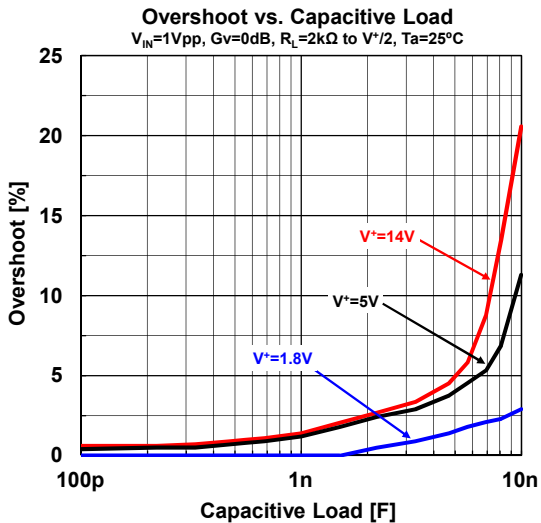
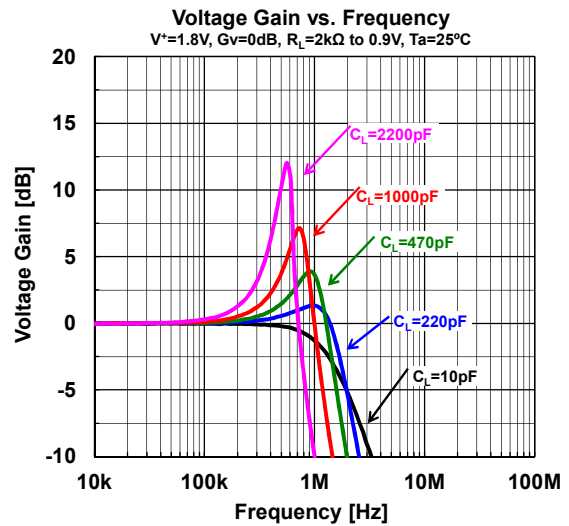
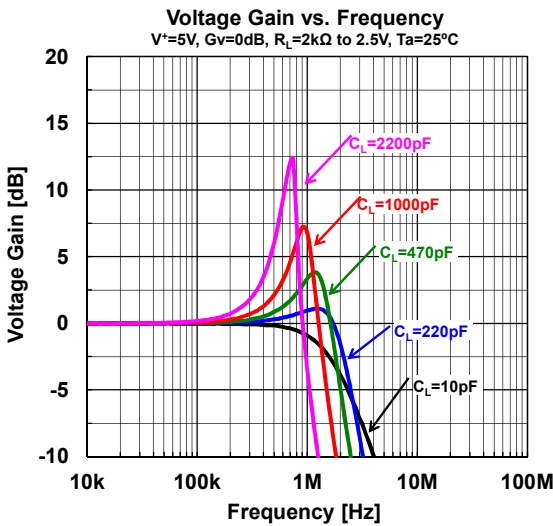
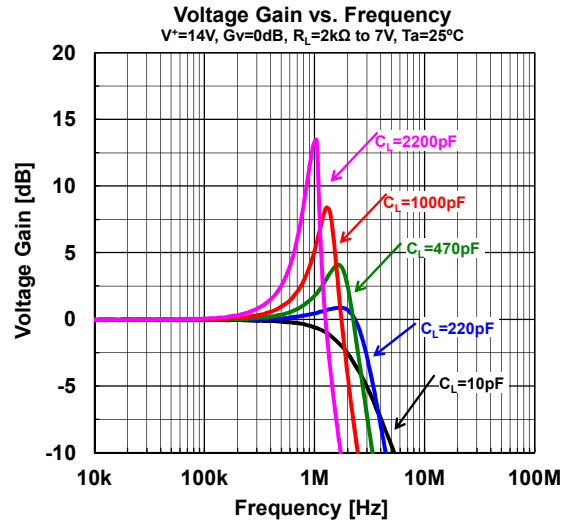
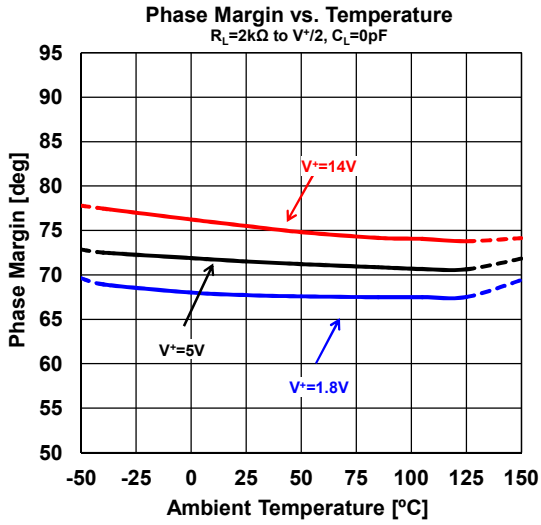

■ TYPICAL CHARACTERISTICS ($V^- = 0V$, $T_a = 25^\circ C$, unless otherwise noted.)

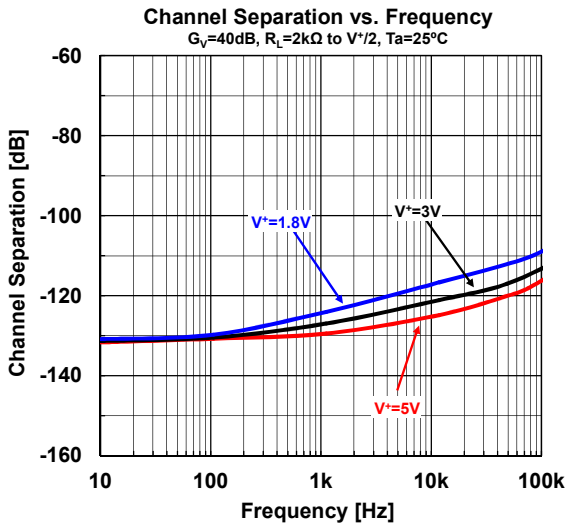
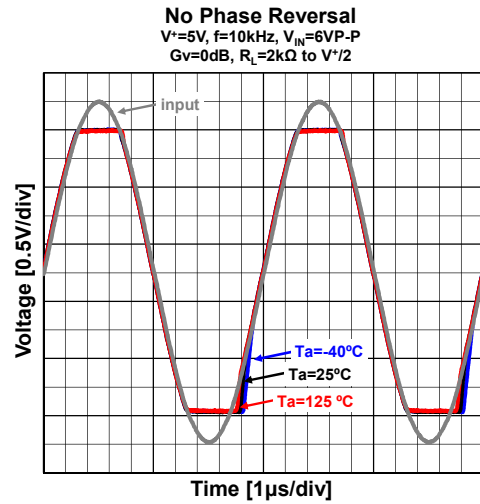
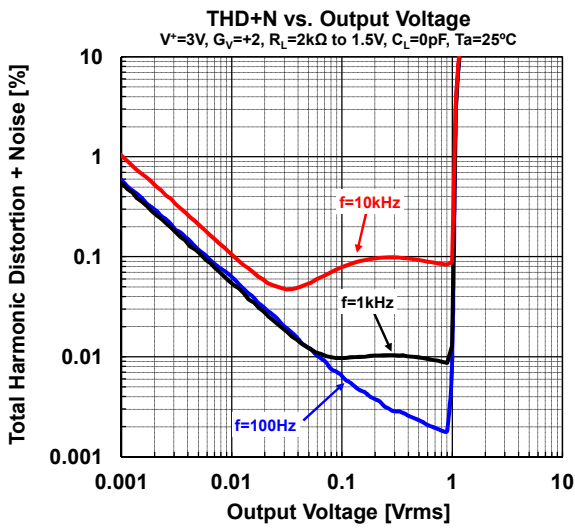
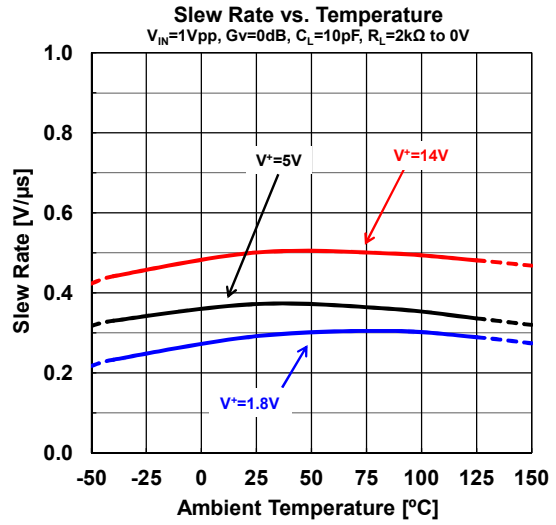
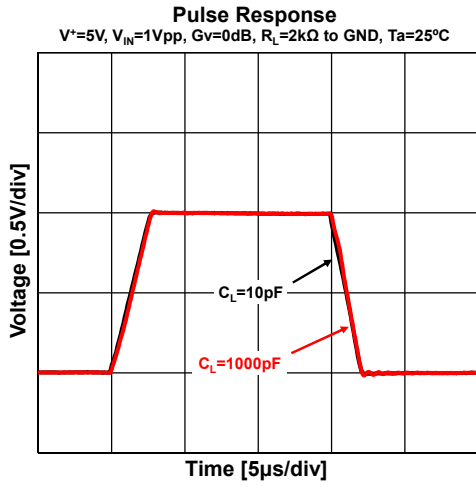

APPLICATIONS INFORMATION

Single and Dual Supply Voltage Operation

The NJM8530/NJM8532/NJM8534 works with both single supply and dual supply when the voltage supplied is between V^+ and V^- . These amplifiers operate from single +1.8 to +14V supply and dual $\pm 0.9V$ to $\pm 7V$ supply.

Common-Mode Input Voltage Range

When the supply voltage does not meet the condition of electrical characteristics, the range of common-mode input voltage is as follows:

$$V_{ICM} (\text{typ.}) = V^- \text{ to } V^+ \quad (T_a = 25^\circ\text{C})$$

Difference of V_{ICM} when Temperature change, refer to typical characteristic graph.

During designing, consider variations in characteristics for use with allowance.

Maximum Output Voltage Range

When the supply voltage does not meet the condition of electrical characteristics, the range of the typ. value of the maximum output voltage is as follows:

$$V_{OM} (\text{typ.}) = V^+ + 50\text{mV} \text{ to } V^- - 50\text{mV} \quad (R_L = 20\text{k}\Omega, T_a = 25^\circ\text{C})$$

During designing, consider variations in characteristics and temperature characteristics for use with allowance.

In addition, also note that the output voltage range becomes narrow as shown in typical characteristics graph when an output current increases.

Rail-to-Rail Input

The input stage of NJM8530/NJM8532/NJM8534 has two input differential pairs, PNP-transistor and NPN-transistor (Figure1). When the common-mode input voltage is at the low end of the negative supply voltage, typically (V^-) to $(V^-) + 0.6V$, the PNP-transistor input differential pair is active and amplifies the input signal. As the common-mode input voltage is increased above the typically $(V^-) + 0.6V$, the NPN-transistor differential pair gradually turns on, thus both pairs are active. When the Common-Mode Input voltage continues increasing near the positive supply voltage, typically $(V^+) - 0.6V$ to positive supply voltage, the PNP-transistor differential pair gradually turns off and amplifies the input signal by NPN-transistor differential pair only. The transition occurs at approximately 0.6V away from both supply rails and results in a change in offset voltage due to the different offset voltage of the differential pairs as shown in figure2.

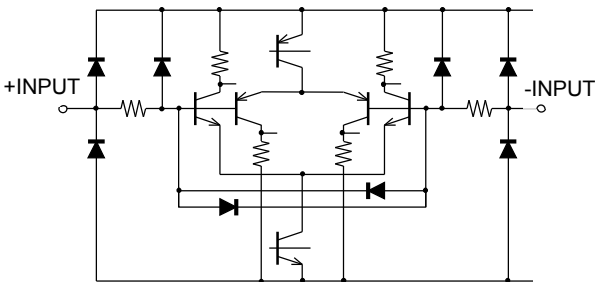

Figure1. Simplified Schematic of Input Stage

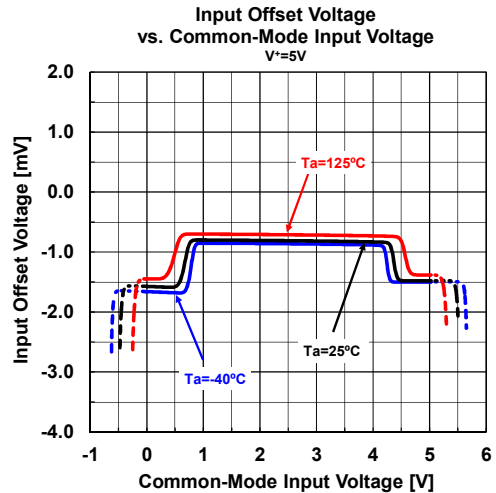

Figure2. Offset Voltage change with common-mode input voltage.

Input Voltage Exceeding the Supply Voltage

Inputs of the NJM8530/NJM8532/NJM8534 are protected by ESD diodes (shown in Figure1) that will conduct if the input voltages exceed the power supplies by more than approximately 300mV. Momentary voltages greater than 300mV beyond the power supply, inputs can be tolerated if the current is limited to 2mA. Figure3 is easily accomplished with an input resistor. If the input voltage exceeds the supply voltage, the input current must be limited 2mA or less by using a restriction resistance (R_{LIMIT}) as shown in figure3.

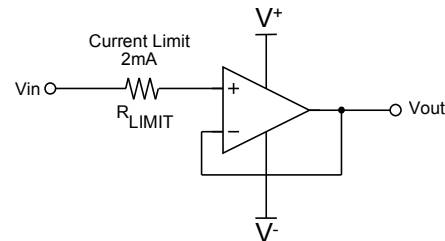

Figure3. Input Current Protection for Voltages Exceeding the Supply Voltage.

Differential Input Voltage

The NJM8530/NJM8532/NJM8534 has internal protection circuitry that prevents damage to the input stage from large differential input voltages. This protection circuitry consists of two diodes and two resistors as shown in figure1. The diodes limit the differential voltage applied to the amplifiers' internal circuitry to no more than diodes' forward-voltage drop (V_F). Input bias current is specified typically 50nA for small differential input voltages. For large differential input voltage above the V_F , this protection circuitry increases the input current at +INPUT and -INPUT. The maximum differential input voltage is 1.0V, but if the differential input voltage exceeds 1.0V, the input current must be limited 2 mA or less by using a restriction resistance.

■ APPLICATIONS INFORMATION

Capacitive load

The NJM8530/NJM8532/NJM8534 can use at unity gain follower, but the unity gain follower is the most sensitive configuration to capacitive loading. The combination of capacitive load placed directly on the output of an amplifier along with the output impedance of the amplifier creates a phase lag which in turn reduces the phase margin of the amplifier. If phase margin is significantly reduced, the response will cause overshoot and ringing in the step response. The NJM8530/NJM8532/NJM8534 is unity gain stable for capacitive loads of 1000pF (see the overshoot vs. capacitive load graph). To drive heavier capacitive loads, an isolation resistor, R_{ISO} as shown Figure4, should be used. R_{ISO} improves the feedback loop's phase margin by making the output load resistive at higher frequencies. The larger the value of R_{ISO} , the more stable the output voltage will be. However, larger values of R_{ISO} result in reduced output swing, reduced output current drive and reduced frequency bandwidth.

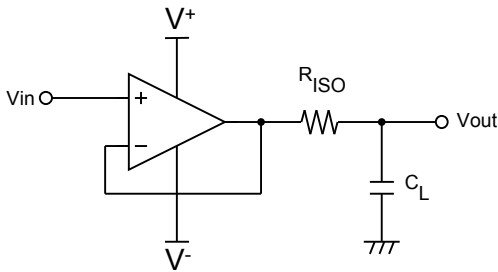
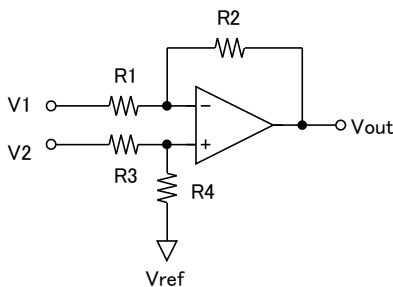

Figure4. Isolating capacitive load

Differential Amplifier

Figure5 shows a one op-amp differential amplifier that consists of the single op-amp and four external resistors. Differential amplifier amplifies the difference between its two input pins, and rejects the common-mode input voltage at both input pins. This is used in variety of applications including current sensing, differential to single-end converter, isolation amplifier to remove common-mode noise.



$$V_{out} = \left(\frac{R1+R2}{R3+R4} \right) \frac{R4}{R1} V_2 - \frac{R2}{R1} V_1 + \left(\frac{R1+R2}{R3+R4} \right) \frac{R3}{R1} V_{ref}$$

$$R1=R3, R2=R4$$

$$V_{out} = \frac{R2}{R1} (V_2 - V_1) + V_{ref}$$

Figure5. Differential Amplifier

The differential amplifier's common-mode rejection ratio (CMR) is primarily determined by resistor mismatches, not by the op-amp's CMR. Ideally, the resistors are chosen such that $R2/R1 = R4/R3$. The CMR due to the resistors in differential amplifier can be calculated using the below formula:

$$CMR_{R_error} \approx 20 \log \left(\frac{1 + \frac{R2}{R1}}{4 R_{error}} \right)$$

$$CMR_{R_error} = \text{CMR due only to the resistors}$$

$$R_{error} = \text{Resistor's tolerance}$$

Example:

$R2/R1=1$ and $R_{error}=0.1\%$, then $CMR=54\text{dB}$

$R2/R1=1$ and $R_{error}=1\%$, then $CMR=34\text{dB}$

If using resistors with 1% tolerance and gain=1, the CMR will only be 34dB.

Current Sensing

Current sensing applications are one such application in a wide range of electronic applications and mostly used for feedback control systems, including power metering battery life indicators and chargers, over-current protection and supervising circuit, automotive, and medical equipment. In such applications, it is desirable to use a shunt with very low resistance to minimize the series voltage drop and minimizes wasted power, and allows the measurement of high current. The NJM8530/NJM8532/NJM8534 is ideal for these current sensing applications.

Figure6 shows a high-side current sensing circuit, and Figure7 shows a low-side current sensing circuit. The NJM8530/NJM8532/NJM8534 has rail-to-rail input and output characteristics, thus allows the both of high-side and low-side current sensing circuit. Furthermore, low supply current of 290 $\mu\text{A}/\text{ch}$ can save the power at battery applications.

The NJM8530/NJM8532/NJM8534 operates up to 14V, and rail-to-rail feature allows the output voltage close to 14V (almost reach the power supply of op-amp). For example, if using a typical shunt resistor of 0.1 Ω , allows the current sensing up to approximately 1.4A of current. The differential amplifier's common-mode rejection ratio (CMR) is primarily determined by resistor mismatches. For details, refer to Differential Amplifiers in the Applications Information.

■ APPLICATIONS INFORMATION

Current Sensing (continues)

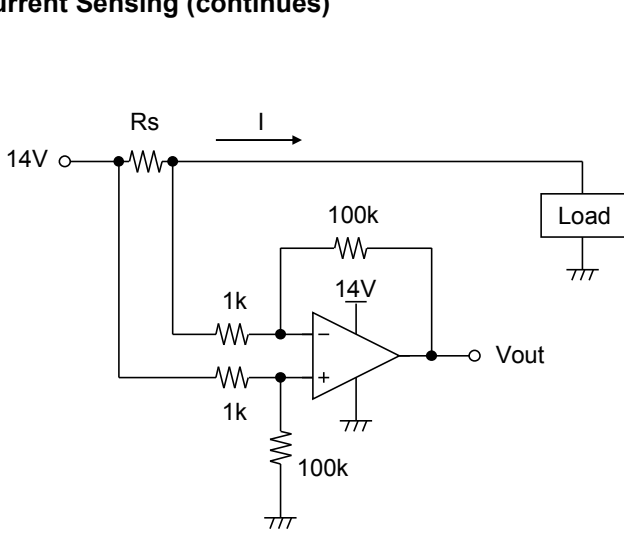

Figure6. High-Side Current Sensing

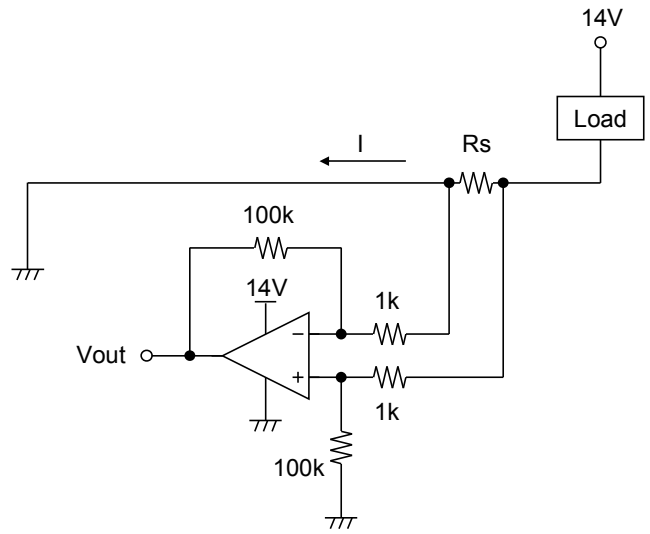
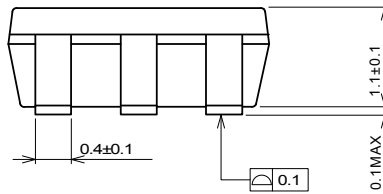
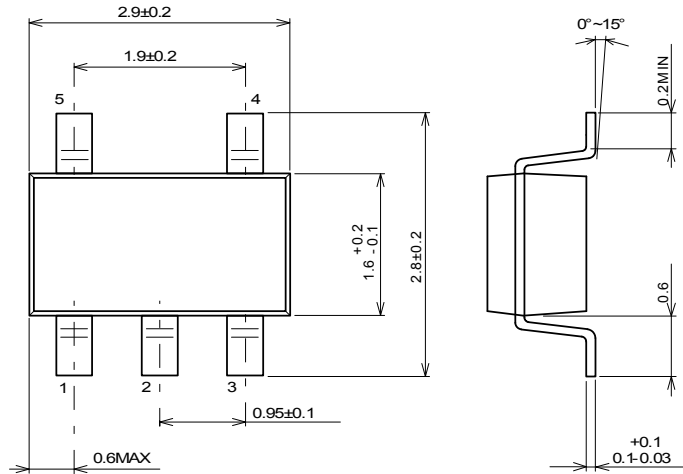

Figure7. Low-Side Current Sensing

■ PACKAGE DIMENSIONS



Unit: mm

SOT-23-5Package

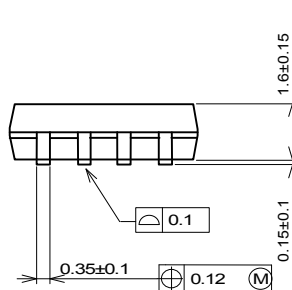
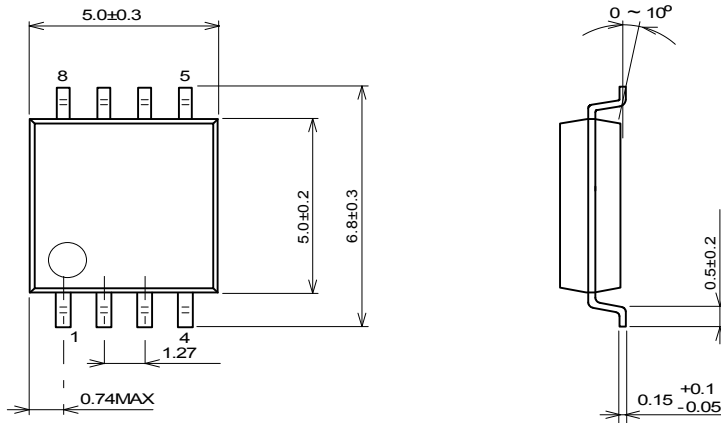

Unit: mm

DMP8 Package

■ PACKAGE DIMENSIONS

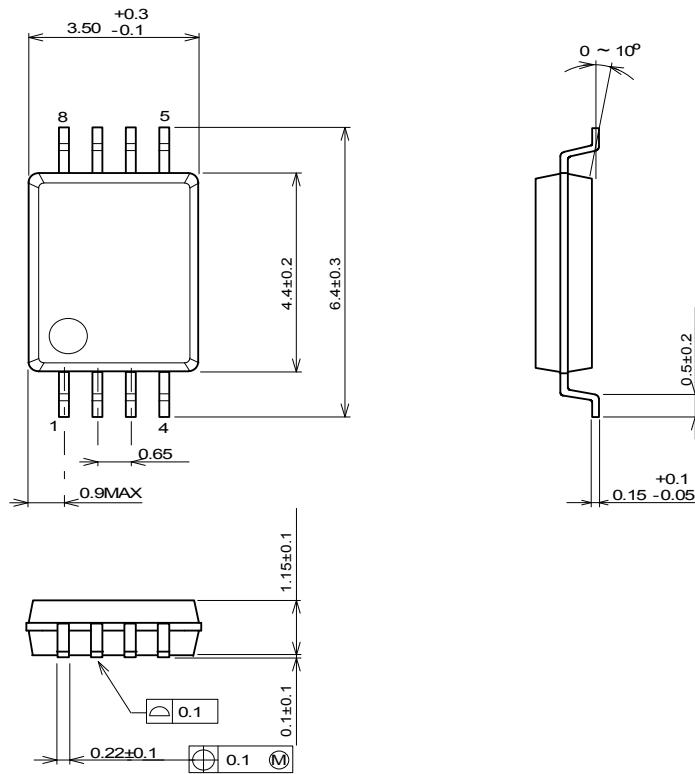

Unit: mm

SSOP8 Package

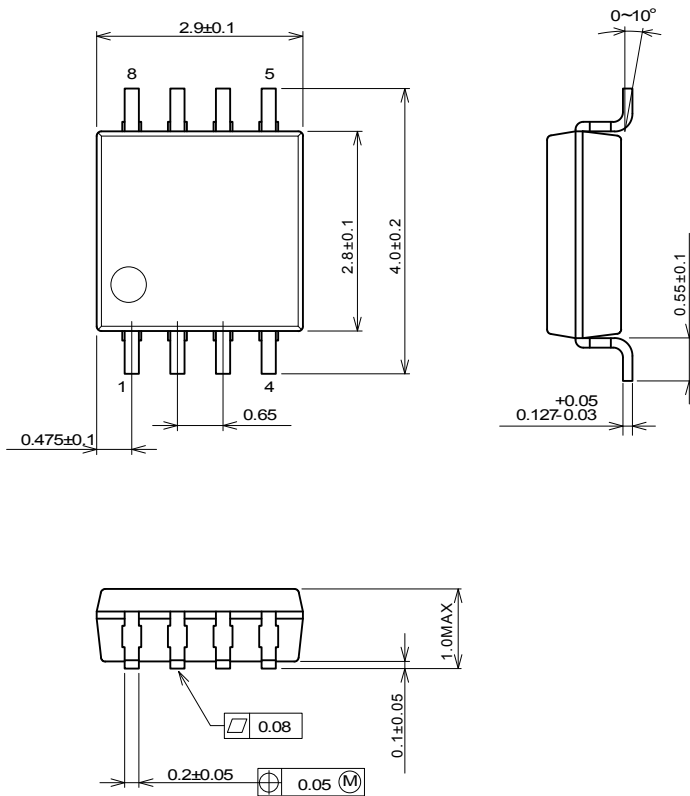

Unit: mm

MSOP8 (TVSP8)
meet JEDEC MO-187-DA / thin Package

■ PACKAGE DIMENSIONS

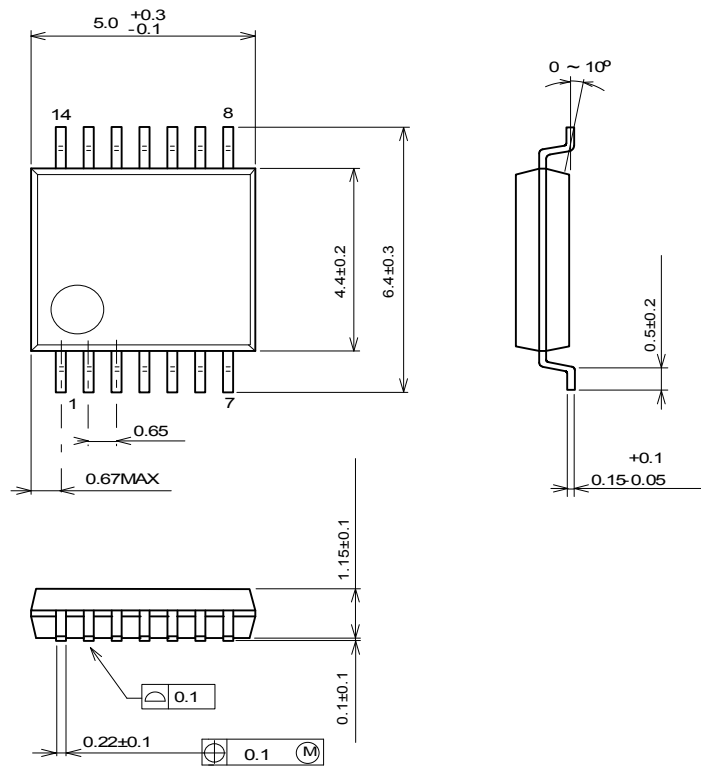

Unit: mm

SSOP14 Package

[CAUTION]
 The specifications on this databook are only given for information, without any guarantee as regards either mistakes or omissions. The application circuits in this databook are described only to show representative usages of the product and not intended for the guarantee or permission of any right including the industrial rights.

Mouser Electronics

Authorized Distributor

Click to View Pricing, Inventory, Delivery & Lifecycle Information:

[NJR:](#)

[NJM8534V](#)



Компания «ЭлектроПласт» предлагает заключение долгосрочных отношений при поставках импортных электронных компонентов на взаимовыгодных условиях!

Наши преимущества:

- Оперативные поставки широкого спектра электронных компонентов отечественного и импортного производства напрямую от производителей и с крупнейших мировых складов;
- Поставка более 17-ти миллионов наименований электронных компонентов;
- Поставка сложных, дефицитных, либо снятых с производства позиций;
- Оперативные сроки поставки под заказ (от 5 рабочих дней);
- Экспресс доставка в любую точку России;
- Техническая поддержка проекта, помощь в подборе аналогов, поставка прототипов;
- Система менеджмента качества сертифицирована по Международному стандарту ISO 9001;
- Лицензия ФСБ на осуществление работ с использованием сведений, составляющих государственную тайну;
- Поставка специализированных компонентов (Xilinx, Altera, Analog Devices, Intersil, Interpoint, Microsemi, Aeroflex, Peregrine, Syfer, Eurofarad, Texas Instrument, Miteq, Cobham, E2V, MA-COM, Hittite, Mini-Circuits, General Dynamics и др.);

Помимо этого, одним из направлений компании «ЭлектроПласт» является направление «Источники питания». Мы предлагаем Вам помощь Конструкторского отдела:

- Подбор оптимального решения, техническое обоснование при выборе компонента;
- Подбор аналогов;
- Консультации по применению компонента;
- Поставка образцов и прототипов;
- Техническая поддержка проекта;
- Защита от снятия компонента с производства.



Как с нами связаться

Телефон: 8 (812) 309 58 32 (многоканальный)

Факс: 8 (812) 320-02-42

Электронная почта: org@eplast1.ru

Адрес: 198099, г. Санкт-Петербург, ул. Калинина, дом 2, корпус 4, литера А.