



NTC thermistors for temperature measurement

SMD NTC thermistors,
case size 0805 (2012)

Series/Type: B574**V2
Date: February 2009

SMD
Applications

- Temperature measurement and compensation

Features

- Multilayer SMD NTC with inner electrodes
- Nickel barrier termination
- Excellent long-term aging stability in high-temperature environment
- Superior resistance stability during soldering (change <1%)

Options

- Alternative resistance ratings, resistance tolerances and B value tolerances available on request.

Delivery mode

Blister tape, 180-mm reel (standard);
330-mm reel (on request)

General technical data

| | | | | |
|-------------------------------|--------------------|---------------------|----------------|------|
| Climatic category | (IEC 60068-1) | | 55/125/56 | |
| Max. power | (at 25 °C, on PCB) | $P_{25}^{(1)}$ | 210 | mW |
| Resistance tolerance | | $\Delta R_R/R_R$ | $\pm 3, \pm 5$ | % |
| Rated temperature | | T_R | 25 | °C |
| Dissipation factor | (on PCB) | $\delta_{th}^{(1)}$ | approx. 3.5 | mW/K |
| Thermal cooling time constant | (on PCB) | $\tau_c^{(1)}$ | approx. 10 | s |
| Heat capacity | | $C_{th}^{(1)}$ | approx. 35 | mJ/K |

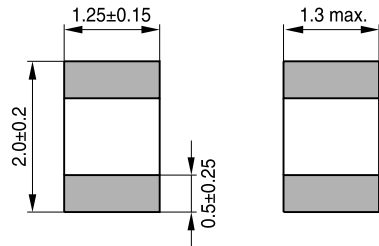
Dimensional drawing

■ Termination

TNT0473-1

Dimensions in mm
Approx. weight 13 mg

1) Depends on mounting situation

SMD
Electrical specification and ordering codes

| R_{25} Ω | No. of R/T characteristic | $B_{25/50}$ K | $B_{25/85}$ K | $B_{25/100}$ K | Ordering code |
|----------------------|------------------------------|------------------|------------------|-------------------|-----------------|
| 100 | 8501 | 3500 | 3540 | 3550 $\pm 3\%$ | B57411V2101+062 |
| 150 | 8501 | 3500 | 3540 | 3550 $\pm 3\%$ | B57411V2151+062 |
| 220 | 8501 | 3500 | 3540 | 3550 $\pm 3\%$ | B57411V2221+062 |
| 330 | 8501 | 3500 | 3540 | 3550 $\pm 3\%$ | B57411V2331+062 |
| 470 | 8502 | 3940 | 3980 | 4000 $\pm 3\%$ | B57421V2471+062 |
| 680 | 8502 | 3940 | 3980 | 4000 $\pm 3\%$ | B57421V2681+062 |
| 1.0 k | 8502 | 3940 | 3980 | 4000 $\pm 3\%$ | B57421V2102+062 |
| 1.5 k | 8502 | 3940 | 3980 | 4000 $\pm 3\%$ | B57421V2152+062 |
| 2.2 k | 8502 | 3940 | 3980 | 4000 $\pm 3\%$ | B57421V2222+062 |
| 3.3 k | 8502 | 3940 | 3980 | 4000 $\pm 3\%$ | B57421V2332+062 |
| 4.7 k | 8500 | 3590 | 3635 | 3650 $\pm 3\%$ | B57401V2472+062 |
| 4.7 k | 8507 | 4386 | 4455 | 4480 $\pm 3\%$ | B57471V2472+062 |
| 6.8 k | 8507 | 4386 | 4455 | 4480 $\pm 3\%$ | B57471V2682+062 |
| 10 k | 8502 | 3940 | 3980 | 4000 $\pm 3\%$ | B57421V2103+062 |
| 10 k | 8507 | 4386 | 4455 | 4480 $\pm 3\%$ | B57471V2103+062 |
| 22 k | 8502 | 3940 | 3980 | 4000 $\pm 3\%$ | B57421V2223+062 |
| 22 k | 8507 | 4386 | 4455 | 4480 $\pm 3\%$ | B57471V2223+062 |
| 33 k | 8502 | 3940 | 3980 | 4000 $\pm 3\%$ | B57421V2333+062 |
| 33 k | 8507 | 4386 | 4455 | 4480 $\pm 3\%$ | B57471V2333+062 |
| 47 k | 8507 | 4386 | 4455 | 4480 $\pm 3\%$ | B57471V2473+062 |
| 100 k | 8507 | 4386 | 4455 | 4480 $\pm 3\%$ | B57471V2104+062 |
| 470 k | 8507 | 4386 | 4455 | 4480 $\pm 3\%$ | B57471V2474+062 |

+ = Resistance tolerance

H = $\pm 3\%$

J = $\pm 5\%$

SMD
Reliability data

SMD NTC thermistors are tested in accordance with IEC 60068. The parts are mounted on a standardized PCB in accordance with IEC 60539-1.

| Test | Standard | Test conditions | $\Delta R_{25}/R_{25}$ (typical) | Remarks |
|------------------------------------|---------------------------------|---|-------------------------------------|----------------------------|
| Storage in dry heat | IEC 60068-2-2 JIS C 0021 | Storage at upper category temperature T: (125 ±2) °C t: 1000 h | < 2% | |
| Storage in damp heat, steady state | IEC 60068-2-78 JIS C 0022 | Temperature of air: (40 ±2) °C Relative humidity of air: (93 +2/-3)% Duration: 56 days | < 2% | |
| Rapid temperature cycling | IEC 60068-2-14 JIS C 0025 | Lower test temperature: -55 °C Upper test temperature: 125 °C Number of cycles: 100 | < 2% | |
| Endurance | | P_{max} : 210 mW T: (65 ±2) °C t: 1000 h | < 2% | |
| Solderability | IEC 60068-2-58 JIS C 0054 | Solderability: (215 ±3) °C, (3 ±0.3) s (235 ±5) °C, (2 ±0.2) s Resistance to soldering heat: (260 ±5) °C, (10 ±1) s | | 95% of terminations wetted |
| Resistance drift after soldering | | Reflow soldering profile Wave soldering profile | < 1% | |



SMD

R/T characteristics

| R/T No. | 8500 | | 8501 | | 8502 | |
|---------|---------------------------------|---------|---------------------------------|---------|---------------------------------|---------|
| T (°C) | B _{25/100} = 3650 K | | B _{25/100} = 3550 K | | B _{25/100} = 4000 K | |
| | R _T /R ₂₅ | α (%/K) | R _T /R ₂₅ | α (%/K) | R _T /R ₂₅ | α (%/K) |
| -55.0 | 63.917 | 6.8 | 56.633 | 6.5 | 96.158 | 7.4 |
| -50.0 | 45.889 | 6.5 | 41.134 | 6.3 | 66.892 | 7.1 |
| -45.0 | 33.344 | 6.3 | 30.209 | 6.1 | 47.127 | 6.9 |
| -40.0 | 24.504 | 6.1 | 22.42 | 5.9 | 33.606 | 6.6 |
| -35.0 | 18.201 | 5.8 | 16.807 | 5.7 | 24.243 | 6.4 |
| -30.0 | 13.657 | 5.6 | 12.721 | 5.5 | 17.681 | 6.2 |
| -25.0 | 10.347 | 5.5 | 9.7156 | 5.3 | 13.032 | 6.0 |
| -20.0 | 7.9114 | 5.3 | 7.4854 | 5.1 | 9.702 | 5.8 |
| -15.0 | 6.1019 | 5.1 | 5.8152 | 5.0 | 7.2923 | 5.6 |
| -10.0 | 4.7454 | 4.9 | 4.5537 | 4.8 | 5.5314 | 5.4 |
| -5.0 | 3.7198 | 4.8 | 3.5931 | 4.7 | 4.2325 | 5.3 |
| 0.0 | 2.938 | 4.6 | 2.8558 | 4.5 | 3.2657 | 5.1 |
| 5.0 | 2.3372 | 4.5 | 2.2857 | 4.4 | 2.54 | 4.9 |
| 10.0 | 1.8722 | 4.4 | 1.8416 | 4.3 | 1.9907 | 4.8 |
| 15.0 | 1.5096 | 4.2 | 1.4934 | 4.1 | 1.5716 | 4.7 |
| 20.0 | 1.2249 | 4.1 | 1.2184 | 4.0 | 1.2494 | 4.5 |
| 25.0 | 1.0000 | 4.0 | 1.0000 | 3.9 | 1.0000 | 4.4 |
| 30.0 | 0.82111 | 3.9 | 0.82537 | 3.8 | 0.80552 | 4.3 |
| 35.0 | 0.67798 | 3.8 | 0.68495 | 3.7 | 0.65288 | 4.1 |
| 40.0 | 0.56279 | 3.7 | 0.57139 | 3.6 | 0.53229 | 4.0 |
| 45.0 | 0.46958 | 3.6 | 0.47905 | 3.5 | 0.43645 | 3.9 |
| 50.0 | 0.39374 | 3.5 | 0.40358 | 3.4 | 0.35981 | 3.8 |
| 55.0 | 0.33171 | 3.4 | 0.34158 | 3.3 | 0.29819 | 3.7 |
| 60.0 | 0.28073 | 3.3 | 0.2904 | 3.2 | 0.24837 | 3.6 |
| 65.0 | 0.23863 | 3.2 | 0.24795 | 3.1 | 0.20787 | 3.5 |
| 70.0 | 0.2037 | 3.1 | 0.21259 | 3.0 | 0.17479 | 3.4 |
| 75.0 | 0.17459 | 3.0 | 0.183 | 3.0 | 0.14763 | 3.3 |
| 80.0 | 0.15022 | 3.0 | 0.15813 | 2.9 | 0.12523 | 3.2 |
| 85.0 | 0.12975 | 2.9 | 0.13715 | 2.8 | 0.10667 | 3.2 |
| 90.0 | 0.11247 | 2.8 | 0.11938 | 2.7 | 0.091227 | 3.1 |
| 95.0 | 0.097838 | 2.8 | 0.10427 | 2.7 | 0.078319 | 3.0 |
| 100.0 | 0.085396 | 2.7 | 0.091375 | 2.6 | 0.067488 | 2.9 |
| 105.0 | 0.074781 | 2.6 | 0.080333 | 2.5 | 0.058363 | 2.9 |
| 110.0 | 0.065691 | 2.6 | 0.070846 | 2.5 | 0.050647 | 2.8 |
| 115.0 | 0.057883 | 2.5 | 0.062666 | 2.4 | 0.044098 | 2.7 |
| 120.0 | 0.051153 | 2.4 | 0.055592 | 2.4 | 0.03852 | 2.7 |
| 125.0 | 0.045335 | 2.4 | 0.049454 | 2.3 | 0.033752 | 2.6 |
| 130.0 | 0.040289 | 2.3 | — | — | 0.029663 | 2.6 |
| 135.0 | 0.0359 | 2.3 | — | — | 0.026146 | 2.5 |
| 140.0 | 0.032071 | 2.2 | — | — | 0.023111 | 2.4 |
| 145.0 | 0.028723 | 2.2 | — | — | 0.020484 | 2.4 |
| 150.0 | 0.025786 | 2.1 | — | — | 0.018203 | 2.3 |

SMD
R/T characteristics

| R/T No. 8507 | | | | | | | | |
|---------------------|---------------------------------|---------|--------|---------------------------------|---------|--------|---------------------------------|---------|
| T (°C) | B _{25/100} = 4480 K | | T (°C) | B _{25/100} = 4480 K | | T (°C) | B _{25/100} = 4480 K | |
| | R _T /R ₂₅ | α (%/K) | | R _T /R ₂₅ | α (%/K) | | R _T /R ₂₅ | α (%/K) |
| -55.0 | 142.71 | 7.9 | 15.0 | 1.6492 | 5.1 | 85.0 | 0.081823 | 3.6 |
| -50.0 | 96.913 | 7.6 | 20.0 | 1.2798 | 5.0 | 90.0 | 0.068589 | 3.5 |
| -45.0 | 66.637 | 7.4 | 25.0 | 1.0000 | 4.9 | 95.0 | 0.057735 | 3.4 |
| -40.0 | 46.366 | 7.1 | 30.0 | 0.78663 | 4.7 | 100.0 | 0.048796 | 3.3 |
| -35.0 | 32.629 | 6.9 | 35.0 | 0.62277 | 4.6 | 105.0 | 0.041403 | 3.2 |
| -30.0 | 23.213 | 6.7 | 40.0 | 0.4961 | 4.5 | 110.0 | 0.035263 | 3.2 |
| -25.0 | 16.686 | 6.5 | 45.0 | 0.39757 | 4.4 | 115.0 | 0.030143 | 3.1 |
| -20.0 | 12.115 | 6.3 | 50.0 | 0.32044 | 4.3 | 120.0 | 0.025858 | 3.0 |
| -15.0 | 8.8803 | 6.1 | 55.0 | 0.2597 | 4.1 | 125.0 | 0.022258 | 3.0 |
| -10.0 | 6.5692 | 5.9 | 60.0 | 0.21161 | 4.0 | 130.0 | 0.019223 | 2.9 |
| -5.0 | 4.9025 | 5.8 | 65.0 | 0.17331 | 3.9 | 135.0 | 0.016655 | 2.8 |
| 0.0 | 3.6896 | 5.6 | 70.0 | 0.14265 | 3.8 | 140.0 | 0.014476 | 2.8 |
| 5.0 | 2.7994 | 5.4 | 75.0 | 0.11799 | 3.8 | 145.0 | 0.012619 | 2.7 |
| 10.0 | 2.1406 | 5.3 | 80.0 | 0.098035 | 3.7 | 150.0 | 0.011033 | 2.7 |

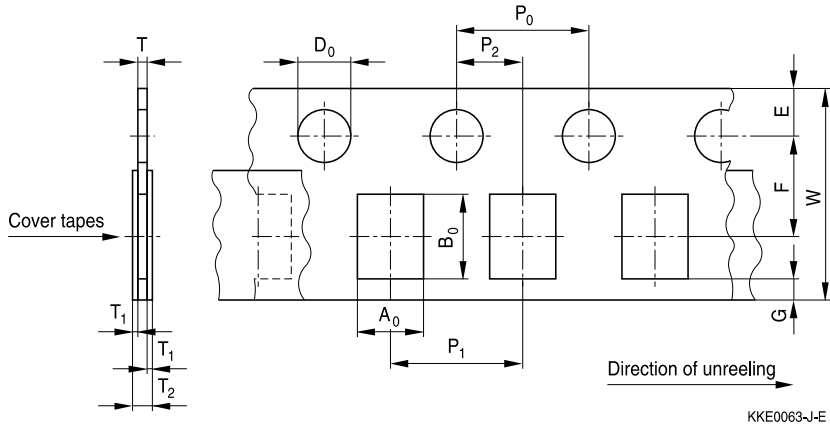
SMD
Taping and packing
1 Taping of SMD NTC thermistors
1.1 Cardboard tape for case size 0402 and 0603 (taping to IEC 60286-3)

Dimensions (mm)

| | Case size 0402 (8-mm tape) | Case size 0603 (8-mm tape) | Tolerance |
|------------------|----------------------------------|----------------------------------|---------------------|
| $A_0 \times B_0$ | 0.60 × 1.15 | 0.95 × 1.80 | ±0.2 |
| T_2 | 0.70 | 1.10 | max. |
| T | 0.60 | 0.90 | max. |
| D_0 | 1.50 | 1.50 | ±0.10 |
| P_0 | 4.00 | 4.00 | ±0.10 ¹⁾ |
| P_2 | 2.00 | 2.00 | ±0.05 |
| P_1 | 2.00 | 4.00 | ±0.10 |
| W | 8.00 | 8.00 | ±0.30 |
| E | 1.75 | 1.75 | ±0.10 |
| F | 3.50 | 3.50 | ±0.05 |
| G | 0.75 | 0.75 | min. |

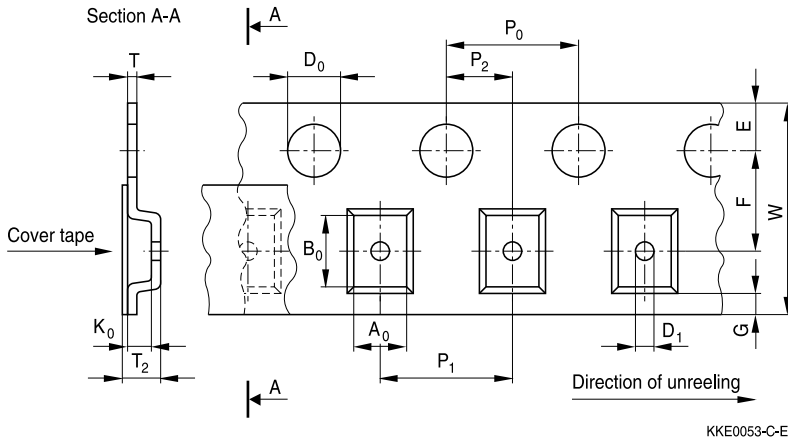
1) ≤0.2 mm over 10 sprocket holes.

SMD
1.2 Blister tape for case size 0805 (taping to IEC 60286-3)

Dimensions (mm)

| | Case size 0805 (8-mm tape) | Tolerance |
|------------------|----------------------------------|-----------------|
| $A_0 \times B_0$ | 1.60×2.40 | ± 0.2 |
| K_0 | 1.40 | max. |
| T_2 | 2.5 | max. |
| D_0 | 1.50 | $+0.10/-0$ |
| D_1 | 1.00 | min. |
| P_0 | 4.00 | $\pm 0.10^{2)}$ |
| P_2 | 2.00 | ± 0.05 |
| P_1 | 4.00 | ± 0.10 |
| W | 8.00 | ± 0.30 |
| E | 1.75 | ± 0.10 |
| F | 3.50 | ± 0.05 |
| G | 0.75 | min. |

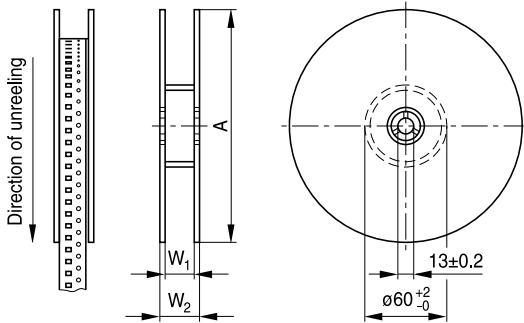
 2) ≤ 0.2 mm over 10 sprocket holes.

SMD
1.3 Reel packing

KKE0058-I

Packing survey

| Case size | Chip thickness ³⁾ mm | 8-mm tape | | Reel dimensions mm | | | | | Packing units | |
|-----------|------------------------------------|-----------|------------|-----------------------|-------|------|---------|-----------|---------------|-------------|
| | | Blister | Card-board | A | Tol. | W1 | Tol. | W2 | 180-mm reel | 330-mm reel |
| 0402 | 0.5 | | x | 180 | -3/+0 | 8.4 | +1.5/-0 | 14.4 max. | 10000 | - |
| 0603 | 0.8 | | x | 180 | -3/+0 | 8.4 | +1.5/-0 | 14.4 max. | 4000 | - |
| | | | | 330 | ±2.0 | 12.4 | +1.5/-0 | 18.4 max. | - | 16000 |
| 0805 | 0.8 | x | | 180 | -3/+0 | 8.4 | +1.5/-0 | 14.4 max. | 4000 | 16000 |
| | 1.2 | x | | 330 | ±2.0 | 12.4 | +1.5/-0 | 18.4 max. | 3000 | 12000 |

3) Chip thickness depends on the resistance value.

SMD
Mounting instructions
1 Soldering
1.1 SMD NTC thermistors

SMD NTC thermistors can be provided with a nickel barrier termination or on special request with silver-palladium termination. The usage of mild, non-activated fluxes for soldering is recommended as well as a proper cleaning of the PCB.

■ Nickel barrier termination

The nickel barrier layer of the silver/nickel/tin termination (see figure 1) prevents leaching of the silver base metalization layer. This allows great flexibility in the selection of soldering parameters.

The tin prevents the nickel layer from oxidizing and thus ensures better wetting by the solder. The nickel barrier termination is suitable for all commonly-used soldering methods.

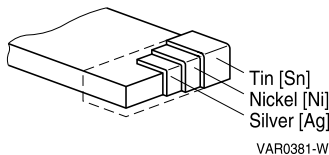

Figure 1

SMD NTC thermistors, structure of nickel barrier termination

1.1.1 Solderability (test to IEC 60068-2-58)

Preconditioning: Immersion into flux F-SW 32.

Evaluation criterion: Wetting of soldering areas $\geq 95\%$.

| Solder | Bath temperature (°C) | Dwell time (s) |
|--------------------------------------|-----------------------|----------------|
| SnPb 60/40 | 215 \pm 3 | 3 |
| SnAg (3.0 ... 4.0), Cu (0.5 ... 0.9) | 245 \pm 3 | 3 |

1.1.2 Resistance to soldering heat (test to IEC 60068-2-58)

Preconditioning: Immersion into flux F-SW 32.

Evaluation criterion: Leaching of side edges $\leq 1/3$.

| Solder | Bath temperature (°C) | Dwell time (s) |
|--------------------------------------|-----------------------|----------------|
| SnPb 60/40 | 260 –5 | 10 |
| SnAg (3.0 ... 4.0), Cu (0.5 ... 0.9) | 260 –5 | 10 |

SMD

Wave soldering

Temperature characteristic at component terminal with dual wave soldering

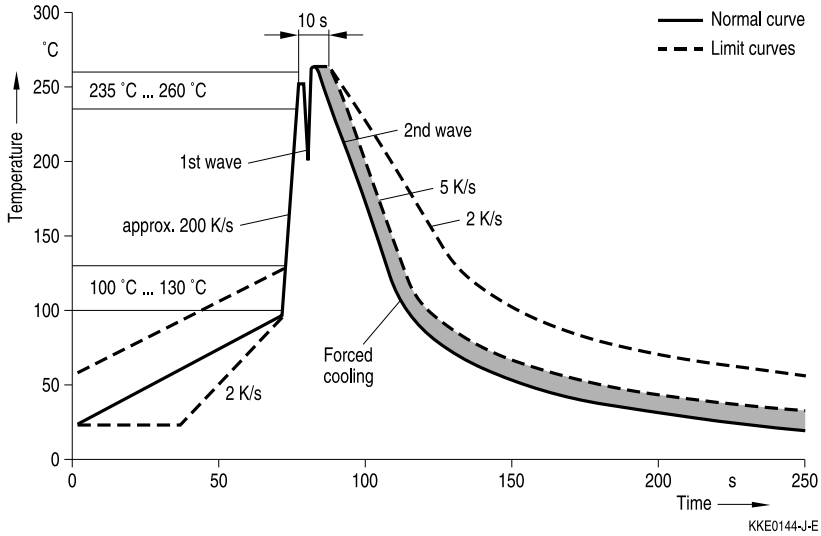

Solder joint profiles for silver/nickel/tin terminations

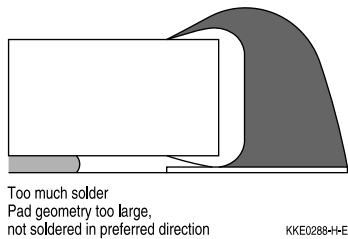
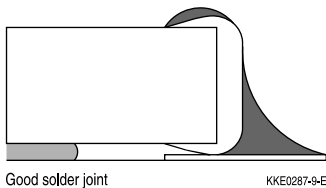

SMD
Reflow soldering

Recommended temperature characteristic for reflow soldering following J-STD-020C

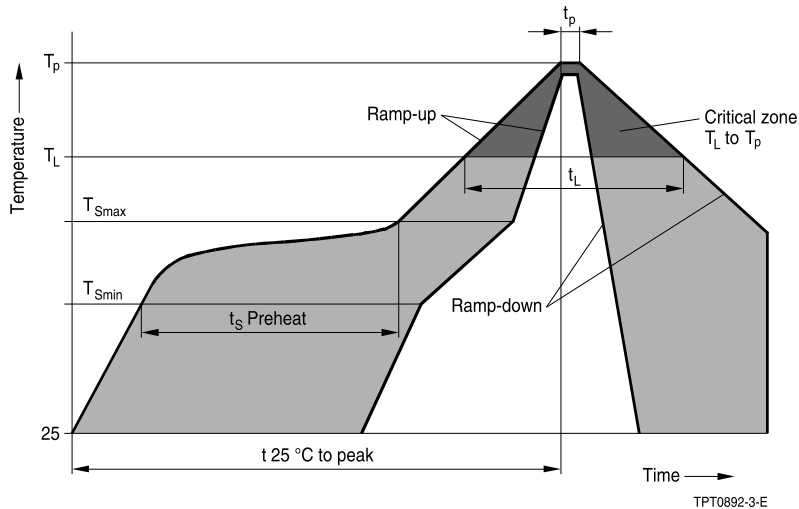

| Profile feature | Sn-Pb eutectic assembly | Pb-free assembly |
|---|-------------------------|--------------------|
| Average ramp-up rate (T_{Smax} to T_p) | 3 °C/ second max. | 3 °C/ second max. |
| Preheat | | |
| - Temperature min (T_{Smin}) | 100 °C | 150 °C |
| - Temperature max (T_{Smax}) | 150 °C | 200 °C |
| - Time (t_{Smin} to t_{Smax}) | 60 ... 120 seconds | 60 ... 180 seconds |
| Time maintained above: | | |
| - Temperature min (T_L) | 183 °C | 217 °C |
| - Time (t_L) | 60 ... 150 seconds | 60 ... 150 seconds |
| Peak/ classification temperature (T_p) | 220 °C ... 240 °C | 240 °C ... 260 °C |
| Time within 5 °C of actual peak temperature (t_p) | 10 ... 30 seconds | 20 ... 40 seconds |
| Ramp-down rate | 6 °C/ second max. | 6 °C/ second max. |
| Time 25 °C to peak temperature | 6 minutes max. | 8 minutes max. |

Note: All temperatures refer to topside of the package, measured on the package body surface.

SMD NTC thermistors, case size 0805 (2012)

SMD

Solder joint profiles for silver/nickel/tin terminations

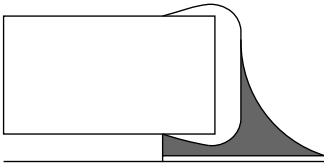

Good solder joint

TNT0565-G-E

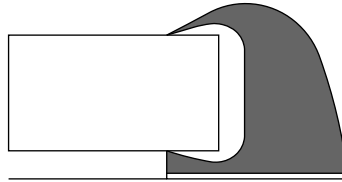

Too much solder
Pad geometry too large

KKE0071-A-E

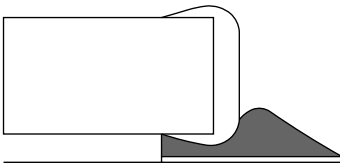

Poor wetting

KKE0072-I-E

1.1.3 Recommended geometry of solder pads

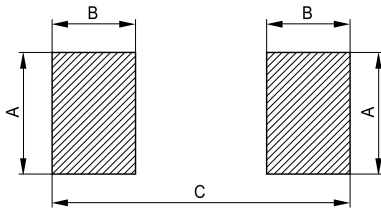

KKE0092-X

Recommended maximum dimensions (mm)

| Case size inch/mm | A | B | C |
|----------------------|-----|-----|-----|
| 0402/1005 | 0.6 | 0.6 | 1.7 |
| 0603/1608 | 1.0 | 1.0 | 3.0 |
| 0805/2012 | 1.3 | 1.2 | 3.4 |

1.1.4 Notes

Iron soldering should be avoided, hot air methods are recommended for repair purposes.

SMD**2 Conductive adhesion**

An alternative to soldering is the gluing of thermistors with conductive adhesives. The benefit of this method is that it involves no thermal stress. The adhesives used must be chemically inert.

3 Sealing and potting

When thermistors are sealed, potted or overmolded, there must be no mechanical stress caused by thermal expansion during the production process (curing / overmolding process) and during later operation. The upper category temperature of the thermistor must not be exceeded. Ensure that the materials used (sealing / potting compound and plastic material) are chemically neutral.

4 Cleaning

If cleaning is necessary, mild cleaning agents such as ethyl alcohol and cleaning gasoline are recommended. Cleaning agents based on water are not allowed. Ultrasonic cleaning methods are permissible.

5 Storage

In order to maintain their solderability, thermistors must be stored in a non-corrosive atmosphere. Humidity, temperature and container materials are critical factors.

Do not store SMDs where they are exposed to heat or direct sunlight. Otherwise, the packing material may be deformed or SMDs may stick together, causing problems during mounting. After opening the factory seals, such as polyvinyl-sealed packages, use the SMDs as soon as possible.

The components should be left in the original packing. Touching the metallization of unsoldered thermistors may change their soldering properties.

Storage temperature: $-25\text{ }^{\circ}\text{C}$ up to $45\text{ }^{\circ}\text{C}$

Relative humidity (without condensation): $\leq 75\%$ annual mean

$< 95\%$, maximum 30 days per annum

Solder the thermistors listed in this data book after shipment from EPCOS within the time specified:

SMDs: 12 months

Leaded components: 24 months

SMD

6 Placement and orientation of SMD NTC thermistors on PCB

a) Component placement

Incorrect

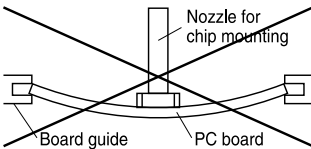

Correct

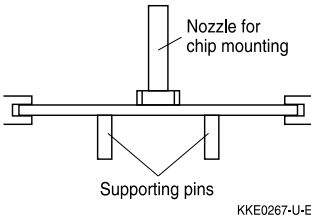

It is recommended that the PC board should be held by means of some adequate supporting pins such as shown left to prevent the SMDs from being damaged or cracked.

b) Cracks

SMDs located near an easily warped area

SMD breakage probability due to stress at a breakaway

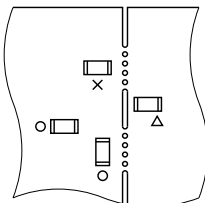
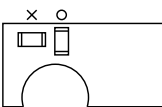

O = correct
X = incorrect
Δ = incorrect (under certain conditions)

KKE0268-3-E

When placing a component near an area which is apt to bend or a grid groove on the PC board, it is advisable to have both electrodes subjected to uniform stress, or to position the component's electrodes at right angles to the grid groove or bending line (see c) Component orientation).

c) Component orientation

Locate chip horizontal to the direction in which stress acts

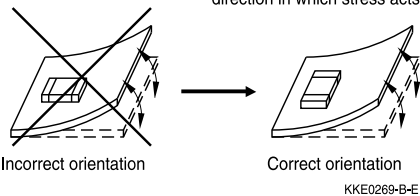

Choose a mounting position that minimizes the stress imposed on the chip during flexing or bending of the board.

SMD

Cautions and warnings General

See "Important notes" at the end of this document.

Storage

- Store thermistors only in original packaging. Do not open the package prior to storage.
- Storage conditions in original packaging: storage temperature $-25\text{ }^{\circ}\text{C} \dots +45\text{ }^{\circ}\text{C}$, relative humidity $\leq 75\%$ annual mean, $< 95\%$ maximum 30 days per annum, dew precipitation is inadmissible.
- Do not store thermistors where they are exposed to heat or direct sunlight. Otherwise, the packing material may be deformed or components may stick together, causing problems during mounting.
- Avoid contamination of thermistor surface during storage, handling and processing.
- Avoid storage of thermistors in harmful environments like corrosive gases (SO_x , Cl etc).
- Use the components as soon as possible after opening the factory seals, i.e. the polyvinyl-sealed packages.
- Solder thermistors within the time specified after shipment from EPCOS.
For leaded components this is 24 months, for SMDs 12 months.

Handling

- NTC thermistors must not be dropped. Chip-offs or any other damage must not be caused during handling of NTCs.
- Do not touch components with bare hands. Gloves are recommended.
- Avoid contamination of thermistor surface during handling.

Bending / twisting leads

- A lead (wire) may be bent at a minimum distance of twice the wire's diameter plus 4 mm from the component head or housing. When bending ensure the wire is mechanically relieved at the component head or housing. The bending radius should be at least 0.75 mm.
- Twisting (torsion) by 180° of a lead bent by 90° is permissible at 6 mm from the bottom of the thermistor body.

Soldering

- Use resin-type flux or non-activated flux.
- Insufficient preheating may cause ceramic cracks.
- Rapid cooling by dipping in solvent is not recommended.
- Complete removal of flux is recommended.

SMD

Mounting

- Ensure that no thermo-mechanical stress occurs due to production processes (curing or overmolding processes) when thermistors are sealed, potted or overmolded or during their subsequent operation. The maximum temperature of the thermistor must not be exceeded. Ensure that the materials used (sealing/potting compound and plastic material) are chemically neutral.
- Electrodes/contacts must not be scratched or damaged before/during/after the mounting process.
- Contacts and housing used for assembly with the thermistor must be clean before mounting.
- Ensure that adjacent materials are designed for operation at temperatures comparable to the surface temperature of the thermistor. Be sure that surrounding parts and materials can withstand the temperature.
- Avoid contamination of the thermistor surface during processing.
- The connections of sensors (e.g. cable end, wire end, plug terminal) may only be exposed to an environment with normal atmospheric conditions.
- Tensile forces on cables or leads must be avoided during mounting and operation.
- Bending or twisting of cables or leads directly on the thermistor body is not permissible.
- Avoid using chemical substances as mounting aids. It must be ensured that no water or other liquids enter the NTC thermistors (e.g. through plug terminals). In particular, water based substances (e.g. soap suds) must not be used as mounting aids for sensors.

Operation

- Use thermistors only within the specified operating temperature range.
- Use thermistors only within the specified power range.
- Environmental conditions must not harm the thermistors. Only use the thermistors under normal atmospheric conditions or within the specified conditions.
- Contact of NTC thermistors with any liquids and solvents should be prevented. It must be ensured that no water enters the NTC thermistors (e.g. through plug terminals). For measurement purposes (checking the specified resistance vs. temperature), the component must not be immersed in water but in suitable liquids (e.g. Galden).
- Avoid dewing and condensation unless thermistor is specified for these conditions.
- Bending or twisting of cables and/or wires is not permissible during operation of the sensor in the application.
- Be sure to provide an appropriate fail-safe function to prevent secondary product damage caused by malfunction.

This listing does not claim to be complete, but merely reflects the experience of EPCOS AG.

SMD
Symbols and terms

| Symbol | English | German |
|---------------------|--|---|
| A | Area | Fläche |
| AWG | American Wire Gauge | Amerikanische Norm für Drahtquerschnitte |
| B | B value | B-Wert |
| B _{25/100} | B value determined by resistance measurement at 25 °C and 100 °C | B-Wert, ermittelt durch Widerstandsmessungen bei 25 °C und 100 °C |
| C _{th} | Heat capacitance | Wärmekapazität |
| I | Current | Strom |
| N | Number (integer) | Anzahl (ganzzahliger Wert) |
| P ₂₅ | Maximum power at 25 °C | Maximale Leistung bei 25 °C |
| P _{diss} | Power dissipation | Verlustleistung |
| P _{ei} | Electrical power | Elektrische Leistung |
| P _{max} | Maximum power within stated temperature range | Maximale Leistung im angegebenen Temperaturbereich |
| $\Delta R_B/R_B$ | Resistance tolerance caused by spread of B value | Widerstandstoleranz, die durch die Streuung des B-Wertes verursacht wird |
| R _{ins} | Insulation resistance | Isolationswiderstand |
| R _p | Parallel resistance | Parallelwiderstand |
| R _R | Rated resistance | Nennwiderstand |
| $\Delta R_R/R_R$ | Resistance tolerance | Widerstandstoleranz |
| R _s | Series resistance | Serienwiderstand |
| R _T | Resistance at temperature T (e.g. R ₂₅ = resistance at 25 °C) | Widerstand bei Temperatur T (z.B. R ₂₅ = Widerstand bei 25 °C) |
| T | Temperature | Temperatur |
| ΔT | Temperature tolerance | Temperaturtoleranz |
| t | Time | Zeit |
| T _A | Ambient temperature | Umgebungstemperatur |
| T _{max} | Upper category temperature | Obere Grenztemperatur (Kategorietemperatur) |
| T _{min} | Lower category temperature | Untere Grenztemperatur (Kategorietemperatur) |
| T _{op} | Operating temperature | Betriebstemperatur |
| T _R | Rated temperature | Nenntemperatur |
| T _{surf} | Surface temperature | Oberflächentemperatur |
| V | Voltage | Spannung |
| V _{ins} | Insulation test voltage | Isolationsprüfspannung |
| V _{op} | Operating voltage | Betriebsspannung |
| V _{test} | Test voltage | Prüfspannung |

SMD

| Symbol | English | German |
|---------------|-------------------------------|--------------------------------|
| α | Temperature coefficient | Temperaturkoeffizient |
| Δ | Tolerance, change | Toleranz, Änderung |
| δ_{th} | Dissipation factor | Wärmeleitwert |
| τ_c | Thermal cooling time constant | Thermische Abkühlzeitkonstante |
| τ_a | Thermal time constant | Thermische Zeitkonstante |

Abbreviations / Notes

| Symbol | English | German |
|-------------------|--|---|
| <u>SMD</u> | Surface-mounted devices | Oberflächenmontierbares Bauelement |
| * | To be replaced by a number in ordering codes, type designations etc. | Platzhalter für Zahl im Bestellnummerncode oder für die Typenbezeichnung. |
| + | To be replaced by a letter. All dimensions are given in mm. The commas used in numerical values denote decimal points. | Platzhalter für einen Buchstaben. Alle Maße sind in mm angegeben. Verwendete Kommas in Zahlenwerten bezeichnen Dezimalpunkte. |

Important notes

The following applies to all products named in this publication:

1. Some parts of this publication contain **statements about the suitability of our products for certain areas of application**. These statements are based on our knowledge of typical requirements that are often placed on our products in the areas of application concerned. We nevertheless expressly point out **that such statements cannot be regarded as binding statements about the suitability of our products for a particular customer application**. As a rule, EPCOS is either unfamiliar with individual customer applications or less familiar with them than the customers themselves. For these reasons, it is always ultimately incumbent on the customer to check and decide whether an EPCOS product with the properties described in the product specification is suitable for use in a particular customer application.
2. We also point out that **in individual cases, a malfunction of electronic components or failure before the end of their usual service life cannot be completely ruled out in the current state of the art, even if they are operated as specified**. In customer applications requiring a very high level of operational safety and especially in customer applications in which the malfunction or failure of an electronic component could endanger human life or health (e.g. in accident prevention or lifesaving systems), it must therefore be ensured by means of suitable design of the customer application or other action taken by the customer (e.g. installation of protective circuitry or redundancy) that no injury or damage is sustained by third parties in the event of malfunction or failure of an electronic component.
3. **The warnings, cautions and product-specific notes must be observed.**
4. In order to satisfy certain technical requirements, **some of the products described in this publication may contain substances subject to restrictions in certain jurisdictions (e.g. because they are classed as hazardous)**. Useful information on this will be found in our Material Data Sheets on the Internet (www.epcos.com/material). Should you have any more detailed questions, please contact our sales offices.
5. We constantly strive to improve our products. Consequently, **the products described in this publication may change from time to time**. The same is true of the corresponding product specifications. Please check therefore to what extent product descriptions and specifications contained in this publication are still applicable before or when you place an order. We also **reserve the right to discontinue production and delivery of products**. Consequently, we cannot guarantee that all products named in this publication will always be available. The aforementioned does not apply in the case of individual agreements deviating from the foregoing for customer-specific products.
6. Unless otherwise agreed in individual contracts, **all orders are subject to the current version of the "General Terms of Delivery for Products and Services in the Electrical Industry" published by the German Electrical and Electronics Industry Association (ZVEI)**.
7. The trade names EPCOS, BAOKE, Alu-X, CeraDiode, CSMP, CSSP, CTVS, DSSP, MiniBlue, MKK, MLSC, MotorCap, PCC, PhaseCap, PhaseCube, PhaseMod, SIFERRIT, SIFI, SIKOREL, SilverCap, SIMDAD, SIMID, SineFormer, SIOV, SIP5D, SIP5K, ThermoFuse, WindCap are **trademarks registered or pending** in Europe and in other countries. Further information will be found on the Internet at www.epcos.com/trademarks.



Компания «ЭлектроПласт» предлагает заключение долгосрочных отношений при поставках импортных электронных компонентов на взаимовыгодных условиях!

Наши преимущества:

- Оперативные поставки широкого спектра электронных компонентов отечественного и импортного производства напрямую от производителей и с крупнейших мировых складов;
- Поставка более 17-ти миллионов наименований электронных компонентов;
- Поставка сложных, дефицитных, либо снятых с производства позиций;
- Оперативные сроки поставки под заказ (от 5 рабочих дней);
- Экспресс доставка в любую точку России;
- Техническая поддержка проекта, помощь в подборе аналогов, поставка прототипов;
- Система менеджмента качества сертифицирована по Международному стандарту ISO 9001;
- Лицензия ФСБ на осуществление работ с использованием сведений, составляющих государственную тайну;
- Поставка специализированных компонентов (Xilinx, Altera, Analog Devices, Intersil, Interpoint, Microsemi, Aeroflex, Peregrine, Syfer, Eurofarad, Texas Instrument, Miteq, Cobham, E2V, MA-COM, Hittite, Mini-Circuits, General Dynamics и др.);

Помимо этого, одним из направлений компании «ЭлектроПласт» является направление «Источники питания». Мы предлагаем Вам помощь Конструкторского отдела:

- Подбор оптимального решения, техническое обоснование при выборе компонента;
- Подбор аналогов;
- Консультации по применению компонента;
- Поставка образцов и прототипов;
- Техническая поддержка проекта;
- Защита от снятия компонента с производства.



Как с нами связаться

Телефон: 8 (812) 309 58 32 (многоканальный)

Факс: 8 (812) 320-02-42

Электронная почта: org@eplast1.ru

Адрес: 198099, г. Санкт-Петербург, ул. Калинина, дом 2, корпус 4, литера А.