

SENSOR-LINK



Conxall's Sensor-Link series includes the Mini-Mizer, AC Micro-Mizer, DC Micro-Mizer and the Nano-Mizer product lines, which are overmolded cable assemblies. The overmolding process provides for environmental sealing and strain relief for flexing applications.

Designed to meet or exceed the requirements of UL, CSA, NEMA, ANSI, IEC and SAE, the Sensor-Link series is intermateable and intermountable with other manufacturers equivalents. Conxall's strength is the combination of application experience and internal manufacturing capabilities that provide the knowledge and flexibility to meet and exceed the expectations of our customers.

Originally developed as an interconnect for a variety of sensing devices, the Sensor-Link series has found a wide range of applications as a general disconnect. Our exceptional quality, service and cost effectiveness makes Sensor-Link series the logical choice.

In our ongoing effort to expand our product offering, we are introducing our Mini and DC Micro Multi-Port box series, Micro/Mini LEDs, Die Block Connectors, and Shielded Nano-Mizer assemblies. Conxall's goal is to be a full service supplier to the sensor market.



TABLE OF CONTENTS

| | |
|---|-------|
| Mini-Mizer® "C" Size | 4-5 |
| Mini-Mizer® "A" Size | 6-10 |
| Mini-Mizer® EMI/RFI Shielded | 11 |
| Mini-Mizer® LED Cordsets | 12 |
| Mini-Mizer® Wiring Sequence Charts & Specifications | 13-15 |
| AC Metal Micro-Mizer® | 16-19 |
| DC Metal Micro-Mizer® | 20-23 |
| Single Key Plastic Micro-Mizer® | 24-25 |
| DC Micro-Mizer® EMI/RFI Shielded | 26 |
| DC Micro-Mizer® LED Cordsets | 27 |
| Micro-Mizer® Wiring Sequence Charts & Specifications | 28-29 |
| Nano-Mizer® and Molded Cord Sets | 30-31 |
| Nano-Mizer® EMI/RFI Shielded | 32 |
| Nano-Mizer® Wiring Sequence Charts and Specifications | 33 |
| Die Block Connectors | 34-36 |
| Die Block Wiring Sequence Charts and Specifications | 37 |
| Multi-Port "A" Size Mini-Mizer® Junction Boxes | 38-39 |
| Multi-Port DC Micro-Mizer® Junction Boxes | 40-42 |
| New Products | 43 |

Warranty

CONXALL® Corp. manufactures the finest quality products available to the marketplace. However, these products are intended to be used in accordance with the specifications described in this catalog. Any use or application that deviates from the stated operating specifications is not recommended and may be unsafe. A limited warranty applies to all CONXALL® Corp. products. Except for obligations specifically assumed by CONXALL® Corp. under warranty, CONXALL® Corp. will not be liable for any loss, damage, cost of repairs, incidental or consequential damages of any kind whether or not based upon expressed or implied warranty, contract, negligence, or strict liability arising in connection with the design, manufacture, sale, use or repair of the products.

All drawings contained in this document are for representational purposes only, and should not be for used final specifications or engineering.

* Please visit the product pages on our website for the most up-to-date product information

SENSOR-LINK MINI-MIZER® "C" Size

MOLDED CONNECTOR ASSEMBLIES



| Face View Male | Rating | Overall Length Inches | Straight Male Single Ended | Straight Female Single Ended | 90° Male Single Ended | 90° Female Single Ended | Straight Inline Male Single Ended | Straight Inline Female Single Ended |
|----------------|--------|-----------------------|----------------------------|------------------------------|-----------------------|-------------------------|-----------------------------------|-------------------------------------|
| | 600V | 36 | 169P36 | 169S36 | 189P36 | 189S36 | 199P36 | 199S36 |
| | | 72 | 169P72 | 169S72 | 189P72 | 189S72 | 199P72 | 199S72 |
| | | 144 | 169P144 | 169S144 | 189P144 | 189S144 | 199P144 | 199S144 |
| | | Custom | 169PXXXX | 169SXXXX | 189PXXXX | 189SXXXX | 199PXXXX | 199SXXXX |
| | 600V | 36 | 1610P36 | 1610S36 | 1810P36 | 1810S36 | 1910P36 | 1910S36 |
| | | 72 | 1610P72 | 1610S72 | 1810P72 | 1810S72 | 1910P72 | 1910S72 |
| | | 144 | 1610P144 | 1610S144 | 1810P144 | 1810S144 | 1910P144 | 1910S144 |
| | | Custom | 1610PXXXX | 1610SXXXX | 1810PXXXX | 1810SXXXX | 1910PXXXX | 1910SXXXX |
| | 600V | 36 | 1612P36 | 1612S36 | 1812P36 | 1812S36 | 1912P36 | 1912S36 |
| | | 72 | 1612P72 | 1612S72 | 1812P72 | 1812S72 | 1912P72 | 1912S72 |
| | | 144 | 1612P144 | 1612S144 | 1812P144 | 1812S144 | 1912P144 | 1912S144 |
| | | Custom | 1612PXXXX | 1612SXXXX | 1812PXXXX | 1812SXXXX | 1912PXXXX | 1912SXXXX |
| | 600V | 36 | 1619P36 | 1619S36 | 1819P36 | 1819S36 | 1919P36 | 1919S36 |
| | | 72 | 1619P72 | 1619S72 | 1819P72 | 1819S72 | 1919P72 | 1919S72 |
| | | 144 | 1619P144 | 1619S144 | 1819P144 | 1819S144 | 1919P144 | 1919S144 |
| | | Custom | 1619PXXXX | 1619SXXXX | 1819PXXXX | 1819SXXXX | 1919PXXXX | 1919SXXXX |

XXXX – Indicates “overall length / lead length” in inches.
For mechanical, electrical and wiring sequence see pages 13-15.
90° assemblies have key position at 12 o’clock.



| Externally Threaded Receptacle Male 12 Inch Leads | Externally Threaded Receptacle Female 12 Inch Leads | Internally Threaded Receptacle Male 12 Inch Leads | Internally Threaded Receptacle Female 12 Inch Leads | Straight Male / Male Double Ended | Straight Female / Female Double Ended | Straight Male / Female Double Ended | Extension Set Inline Male / Female Double Ended | Extension Set Inline Female / Male Double Ended |
|---|---|---|---|-----------------------------------|---------------------------------------|-------------------------------------|---|---|
| 179P12 | 179S12 | 179PN12 | 179SN12 | 569P9P36 | 569S9S36 | 569P9S36 | 519P9S36 | 519S9P36 |
| | | | | 569P9P72 | 569S9S72 | 569P9S72 | 519P9S72 | 519S9P72 |
| 179PXXX | 179SXXX | 179PNXXX | 179SNXXX | 569P9P144 | 569S9S144 | 569P9S144 | 519P9S144 | 519S9P144 |
| | | | | 569P9PXXX | 569S9SXXX | 569P9SXXX | 519P9SXXX | 519S9PXXX |
| 1710P12 | 1710S12 | 1710PN12 | 1710SN12 | 5610P10P36 | 5610S10S36 | 5610P10S36 | 5110P10S36 | 5110S10P36 |
| | | | | 5610P10P72 | 5610S10S72 | 5610P10S72 | 5110P10S72 | 5110S10P72 |
| 1710PXXX | 1710SXXX | 1710PNXXX | 1710SNXXX | 5610P10P144 | 5610S10S144 | 5610P10S144 | 5110P10S144 | 5110S10P144 |
| | | | | 5610P10PXXX | 5610S10SXXX | 5610P10SXXX | 5110P10SXXX | 5110S10PXXX |
| 1712P12 | 1712S12 | 1712PN12 | 1712SN12 | 5612P12P36 | 5612S12S36 | 5612P12S36 | 5112P12S36 | 5112S12P36 |
| | | | | 5612P12P72 | 5612S12S72 | 5612P12S72 | 5112P12S72 | 5112S12P72 |
| 1712PXXX | 1712SXXX | 1712PNXXX | 1712SNXXX | 5612P12P144 | 5612S12S144 | 5612P12S144 | 5112P12S144 | 5112S12P144 |
| | | | | 5612P12PXXX | 5612S12SXXX | 5612P12SXXX | 5112P12SXXX | 5112S12PXXX |
| 1719P12 | 1719S12 | 1719PN12 | 1719SN12 | 5619P19P36 | 5619S19S36 | 5619P19S36 | 5119P19S36 | 5119S19P36 |
| | | | | 5619P19P72 | 5619S19S72 | 5619P19S72 | 5119P19S72 | 5119S19P72 |
| 1719PXXX | 1719SXXX | 1719PNXXX | 1719SNXXX | 5619P19P144 | 5619S19S144 | 5619P19S144 | 5119P19S144 | 5119S19P144 |
| | | | | 5619P19PXXX | 5619S19SXXX | 5619P19SXXX | 5119P19SXXX | 5119S19PXXX |

XXXX - Indicates "overall length / lead length" in inches.
 For mechanical, electrical and wiring sequence see pages 13-15.



* Please visit the product pages on our website for the most up-to-date product information

SENSOR-LINK MINI-MIZER® "A" Size

MOLDED CONNECTOR ASSEMBLIES



| Face View Male | Rating | Overall Length Inches | Straight Male Single Ended | Straight Female Single Ended | 90° Male Single Ended | 90° Female Single Ended | Straight Inline Male Single Ended | Straight Inline Female Single Ended | Externally Threaded Receptacle Male 12 Inch Leads |
|----------------|-------------|-----------------------|----------------------------|------------------------------|-----------------------|-------------------------|-----------------------------------|-------------------------------------|---|
| | 13A 600V | 36 | 162P36 | 162S36 | 182P36 | 182S36 | 192P36 | 192S36 | 172P12 |
| | | 72 | 162P72 | 162S72 | 182P72 | 182S72 | 192P72 | 192S72 | |
| | | 144 | 162P144 | 162S144 | 182P144 | 182S144 | 192P144 | 192S144 | |
| | | Custom | 162PXXXX | 162SXXXX | 182PXXXX | 182SXXXX | 192PXXXX | 192SXXXX | |
| | 13A 600V | 36 | 163P36 | 163S36 | 183P36 | 183S36 | 193P36 | 193S36 | 173P12 |
| | | 72 | 163P72 | 163S72 | 183P72 | 183S72 | 193P72 | 193S72 | |
| | | 144 | 163P144 | 163S144 | 183P144 | 183S144 | 193P144 | 193S144 | |
| | | Custom | 163PXXXX | 163SXXXX | 183PXXXX | 183SXXXX | 193PXXXX | 193SXXXX | |
| | 10A 600V | 36 | 164P36 | 164S36 | 184P36 | 184S36 | 194P36 | 194S36 | 174P12 |
| | | 72 | 164P72 | 164S72 | 184P72 | 184S72 | 194P72 | 194S72 | |
| | | 144 | 164P144 | 164S144 | 184P144 | 184S144 | 194P144 | 194S144 | |
| | | Custom | 164PXXXX | 164SXXXX | 184PXXXX | 184SXXXX | 194PXXXX | 194SXXXX | |
| | 8A 600V | 36 | 165P36 | 165S36 | 185P36 | 185S36 | 195P36 | 195S36 | 175P12 |
| | | 72 | 165P72 | 165S72 | 185P72 | 185S72 | 195P72 | 195S72 | |
| | | 144 | 165P144 | 165S144 | 185P144 | 185S144 | 195P144 | 195S144 | |
| | | Custom | 165PXXXX | 165SXXXX | 185PXXXX | 185SXXXX | 195PXXXX | 195SXXXX | |
| | 8A 600V | 36 | 166P36 | 166S36 | 186P36 | 186S36 | 196P36 | 196S36 | 176P12 |
| | | 72 | 166P72 | 166S72 | 186P72 | 186S72 | 196P72 | 196S72 | |
| | | 144 | 166P144 | 166S144 | 186P144 | 186S144 | 196P144 | 196S144 | |
| | | Custom | 166PXXXX | 166SXXXX | 186PXXXX | 186SXXXX | 196PXXXX | 196SXXXX | |

XXXX – Indicates “overall length / lead length” in inches.
For mechanical, electrical and wiring sequence see pages 13-15.
90° assemblies have key position at 12 o’clock.



| Externally Threaded Receptacle Female 12 Inch Leads | Internally Threaded Receptacle Male 12 Inch Leads | Internally Threaded Receptacle Female 12 Inch Leads | Straight Male /Male Double Ended | Straight Female /Female Double Ended | Straight Male /Female Double Ended | 90° Male /Male Double Ended | 90° Female /Female Double Ended | 90° Male /Female Double Ended |
|---|---|---|----------------------------------|--------------------------------------|------------------------------------|-----------------------------|---------------------------------|-------------------------------|
| 172S12 | 172PN12 | 172SN12 | 562P2P36 | 562S2S36 | 562P2S36 | 542P2P36 | 542S2S36 | 542P2S36 |
| | | | 562P2P72 | 562S2S72 | 562P2S72 | 542P2P72 | 542S2S72 | 542P2S72 |
| | | | 562P2P144 | 562S2S144 | 562P2S144 | 542P2P144 | 542S2S144 | 542P2S144 |
| 172SXXX | 172PNXXX | 172SNXXX | 562P2PXXXX | 562S2SXXXX | 562P2SXXXX | 542P2PXXXX | 542S2SXXXX | 542P2SXXXX |
| | | | 563P3P36 | 563S3S36 | 563P3S36 | 543P3P36 | 543S3S36 | 543P3S36 |
| 173S12 | 173PN12 | 173SN12 | 563P3P72 | 563S3S72 | 563P3S72 | 543P3P72 | 543S3S72 | 543P3S72 |
| | | | 563P3P144 | 563S3S144 | 563P3S144 | 543P3P144 | 543S3S144 | 543P3S144 |
| 173SXXX | 173PNXXX | 173SNXXX | 563P3PXXXX | 563S3SXXXX | 563P3SXXXX | 543P3PXXXX | 543S3SXXXX | 543P3SXXXX |
| | | | 564P4P36 | 564S4S36 | 564P4S36 | 544P4P36 | 544S4S36 | 544P4S36 |
| 174S12 | 174PN12 | 174SN12 | 564P4P72 | 564S4S72 | 564P4S72 | 544P4P72 | 544S4S72 | 544P4S72 |
| | | | 564P4P144 | 564S4S144 | 564P4S144 | 544P4P144 | 544S4S144 | 544P4S144 |
| 174SXXX | 174PNXXX | 174SNXXX | 564P4PXXXX | 564S4SXXXX | 564P4SXXXX | 544P4PXXXX | 544S4SXXXX | 544P4SXXXX |
| | | | 565P5P36 | 565S5S36 | 565P5S36 | 545P5P36 | 545S5S36 | 545P5S36 |
| 175S12 | 175PN12 | 175SN12 | 565P5P72 | 565S5S72 | 565P5S72 | 545P5P72 | 545S5S72 | 545P5S72 |
| | | | 565P5P144 | 565S5S144 | 565P5S144 | 545P5P144 | 545S5S144 | 545P5S144 |
| 175SXXX | 175PNXXX | 175SNXXX | 565P5PXXXX | 565S5SXXXX | 565P5SXXXX | 545P5PXXXX | 545S5SXXXX | 545P5SXXXX |
| | | | 566P6P36 | 566S6S36 | 566P6S36 | 546P6P36 | 546S6S36 | 546P6S36 |
| 176S12 | 176PN12 | 176SN12 | 566P6P72 | 566S6S72 | 566P6S72 | 546P6P72 | 546S6S72 | 546P6S72 |
| | | | 566P6P144 | 566S6S144 | 566P6S144 | 546P6P144 | 546S6S144 | 546P6S144 |
| 176SXXX | 176PNXXX | 176SNXXX | 566P6PXXXX | 566S6SXXXX | 566P6SXXXX | 546P6PXXXX | 546S6SXXXX | 546P6SXXXX |

XXXX – Indicates “overall length / lead length” in inches.
 For mechanical, electrical and wiring sequence see pages 13-15.
 90° assemblies have key position at 12 o'clock.

* Please visit the product pages on our website for the most up-to-date product information

SENSOR-LINK MINI-MIZER® "A" Size

MOLDED CONNECTOR ASSEMBLIES



| Face View Male | Rating | Overall Length Inches | Straight Extension Set Inline Male /Female Double Ended | Straight Extension Set Inline Female /Male Double Ended | Straight to 90° Male /Male Double Ended | Straight to 90° Female /Female Double Ended | Straight to 90° Male /Female Double Ended | Straight to 90° Female /Male Double Ended |
|----------------|-------------|-----------------------|---|---|---|---|---|---|
| | 13A 600V | 36 | 512P2S36 | 512S2P36 | 552P2P36 | 552S2S36 | 552P2S36 | 552S2P36 |
| | | 72 | 512P2S72 | 512S2P72 | 552P2P72 | 552S2S72 | 552P2S72 | 552S2P72 |
| | | 144 | 512P2S144 | 512S2P144 | 552P2P144 | 552S2S144 | 552P2S144 | 552S2P144 |
| | | Custom | 512P2SXXXX | 512S2PXXXX | 552P2PXXXX | 552S2SXXXX | 552P2SXXXX | 552S2PXXXX |
| | 13A 600V | 36 | 513P3S36 | 513S3P36 | 553P3P36 | 553S3S36 | 553P3S36 | 553S3P36 |
| | | 72 | 513P3S72 | 513S3P72 | 553P3P72 | 553S3S72 | 553P3S72 | 553S3P72 |
| | | 144 | 513P3S144 | 513S3P144 | 553P3P144 | 553S3S144 | 553P3S144 | 553S3P144 |
| | | Custom | 513P3SXXXX | 513S3PXXXX | 553P3PXXXX | 553S3SXXXX | 553P3SXXXX | 553S3PXXXX |
| | 10A 600V | 36 | 514P4S36 | 514S4P36 | 554P4P36 | 554S4S36 | 554P4S36 | 554S4P36 |
| | | 72 | 514P4S72 | 514S4P72 | 554P4P72 | 554S4S72 | 554P4S72 | 554S4P72 |
| | | 144 | 514P4S144 | 514S4P144 | 554P4P144 | 554S4S144 | 554P4S144 | 554S4P144 |
| | | Custom | 514P4SXXXX | 514S4PXXXX | 554P4PXXXX | 554S4SXXXX | 554P4SXXXX | 554S4PXXXX |
| | 8A 600V | 36 | 515P5S36 | 515S5P36 | 555P5P36 | 555S5S36 | 555P5S36 | 555S5P36 |
| | | 72 | 515P5S72 | 515S5P72 | 555P5P72 | 555S5S72 | 555P5S72 | 555S5P72 |
| | | 144 | 515P5S144 | 515S5P144 | 555P5P144 | 555S5S144 | 555P5S144 | 555S5P144 |
| | | Custom | 515P5SXXXX | 515S5PXXXX | 555P5PXXXX | 555S5SXXXX | 555P5SXXXX | 555S5PXXXX |
| | 8A 600V | 36 | 516P6S36 | 516S6P36 | 556P6P36 | 556S6S36 | 556P6S36 | 556S6P36 |
| | | 72 | 516P6S72 | 516S6P72 | 556P6P72 | 556S6S72 | 556P6S72 | 556S6P72 |
| | | 144 | 516P6S144 | 516S6P144 | 556P6P144 | 556S6S144 | 556P6S144 | 556S6P144 |
| | | Custom | 516P6SXXXX | 516S6PXXXX | 556P6PXXXX | 556S6SXXXX | 556P6SXXXX | 556S6PXXXX |

XXXX - Indicates "overall length" in inches.
For mechanical, electrical and wiring sequence see pages 13-15.
90° assemblies have key position at 12 o'clock.



| Face View Male | Rating | Wiring Diagram | Cable Length Inches | Y-Splitter Female/Female Female | Y-Splitter Male/Female Female |
|----------------|-------------|----------------|---------------------|---------------------------------|-------------------------------|
| | 10A 300V | | 12 Custom | 592S2S2S12 592S2S2SXXX | 592P2S2S12 592P2S2SXXX |
| | 10A 300V | | 12 Custom | 593S3S3S12 593S3S3SXXX | 593P3S3S12 593P3S3SXXX |
| | 8A 300V | | 12 Custom | 594S4S4S12 594S4S4SXXX | 594P4S4S12 594P4S4SXXX |
| | 6A 300V | | 12 Custom | 595S5S5S12 595S5S5SXXX | 595P5S5S12 595P5S5SXXX |
| | 6A 300V | | 12 Custom | 596S6S6S12 596S6S6SXXX | 596P6S6S12 596P6S6SXXX |

For insert combinations not shown - consult factory.
 XXX - Indicates "cable length" in inches.
 For mechanical, electrical and wiring sequence see pages 13-15.

| Face View Male | Rating | Terminator Male | Terminator Female |
|----------------|----------|-----------------|-------------------|
| | 8A, 600V | 535P | 535S |

Consult factory for other insert configurations.

| Shorting Plug Male | Shorting Plug Female |
|--------------------|----------------------|
| 52XPYY | 52XSYY |

X indicates number of contacts
 YY indicates shorting positions
 Shorting plug utilizes a jumper wire (no resistor)



* Please visit the product pages on our website for the most up-to-date product information

SENSOR-LINK MINI-MIZER® "A" Size

MOLDED CONNECTOR ASSEMBLIES



| Face View Male | Rating | Wiring Diagram | Cable Length Inches | Dual Connector with Cable Male/Female | Dual Connector with Cable Female/Female |
|----------------|-------------|----------------|---------------------|---------------------------------------|---|
| | 13A 600V | | 36 Custom | 572P2S36 572P2SXXX | 572S2S36 572S2SXXX |
| | 13A 600V | | 36 Custom | 573P3S36 573P3SXXX | 573S3S36 573S3SXXX |
| | 10A 600V | | 36 Custom | 574P4S36 574P4SXXX | 574S4S36 574S4SXXX |
| | 8A 600V | | 36 Custom | 575P5S36 575P5SXXX | 575S5S36 575S5SXXX |
| | 8A 600V | | 36 Custom | 576P6S36 576P6SXXX | 576S6S36 576S6SXXX |

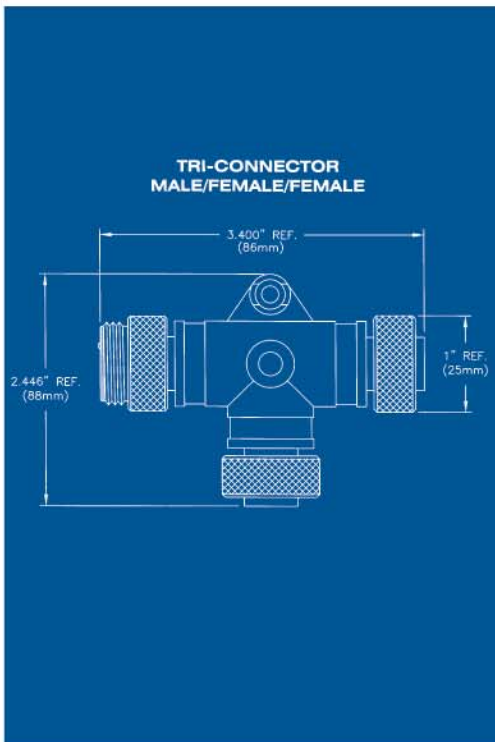

| Face View Male | Rating | Wiring Diagram | Tri-Connector Male/Female Female | Tri-Connector Female/Female Female |
|----------------|-------------|----------------|----------------------------------|------------------------------------|
| | 13A 600V | | 582P2S2S | 582S2S2S |
| | 13A 600V | | 583P3S3S | 583S3S3S |
| | 10A 600V | | 584P4S4S | 584S4S4S |
| | 8A 600V | | 585P5S5S | 585S5S5S |
| | 8A 600V | | 586P6S6S | 586S6S6S |

XXX – Indicates “cable length” in inches.
For mechanical, electrical and wiring sequence see pages 13-15.
For insert combinations not shown - consult factory.

* Please visit the product pages on our website for the most up-to-date product information

SENSOR-LINK MINI-MIZER® "A" Size EMI/RFI SHIELDED MOLDED CONNECTOR ASSEMBLIES



| Face View Male | Rating | Overall Length Inches | Straight Male or Female Single Ended | Straight Inline Male or Female Single Ended | Straight Extension Set Male or Female Double Ended | Straight Male or Female Double Ended | Receptacle Male or Female 12 Inch leads |
|----------------|-------------|-----------------------|--------------------------------------|---|--|--------------------------------------|---|
| | 13A 600V | 36 | SH162*36 | SH192*36 | SH512*2*36 | SH562*2*36 | |
| | | 72 | SH162*72 | SH192*72 | SH512*2*72 | SH562*2*72 | SH172*12 |
| | | 144 | SH162*144 | SH192*144 | SH512*2*144 | SH562*2*144 | |
| | | Custom | SH162*XXXX | SH192*XXXX | SH512*2*XXXX | SH562*2*XXXX | SH172*XXX |
| | 13A 600V | 36 | SH163*36 | SH193*36 | SH513*3*36 | SH563*3*36 | |
| | | 72 | SH163*72 | SH193*72 | SH513*3*72 | SH563*3*72 | SH173*12 |
| | | 144 | SH163*144 | SH193*144 | SH513*3*144 | SH563*3*144 | |
| | | Custom | SH163*XXXX | SH193*XXXX | SH513*3*XXXX | SH563*3*XXXX | SH173*XXX |
| | 10A 600V | 36 | SH164*36 | SH194*36 | SH514*4*36 | SH564*4*36 | |
| | | 72 | SH164*72 | SH194*72 | SH514*4*72 | SH564*4*72 | SH174*12 |
| | | 144 | SH164*144 | SH194*144 | SH514*4*144 | SH564*4*144 | |
| | | Custom | SH164*XXXX | SH194*XXXX | SH514*4*XXXX | SH564*4*XXXX | SH174*XXX |
| | 8A 600V | 36 | SH165*36 | SH195*36 | SH515*5*36 | SH565*5*36 | |
| | | 72 | SH165*72 | SH195*72 | SH515*5*72 | SH565*5*72 | SH175*12 |
| | | 144 | SH165*144 | SH195*144 | SH515*5*144 | SH565*5*144 | |
| | | Custom | SH165*XXXX | SH195*XXXX | SH515*5*XXXX | SH565*5*XXXX | SH175*XXX |
| | 8A 600V | 36 | SH166*36 | SH196*36 | SH516*6*36 | SH566*6*36 | |
| | | 72 | SH166*72 | SH196*72 | SH516*6*72 | SH566*6*72 | SH176*12 |
| | | 144 | SH166*144 | SH196*144 | SH516*6*144 | SH566*6*144 | |
| | | Custom | SH166*XXXX | SH196*XXXX | SH516*6*XXXX | SH566*6*XXXX | SH176*XXX |

*** - Indicates Gender "P" = Male (Pins) or "S" = Female (Sockets).
XXXX - Indicates "overall length / cable length" in inches.
For mechanical, electrical and wiring sequence see pages 13-15.



* Please visit the product pages on our website for the most up-to-date product information

SENSOR-LINK MINI-MIZER® "A" Size LED Cordsets

MOLDED CONNECTOR ASSEMBLIES

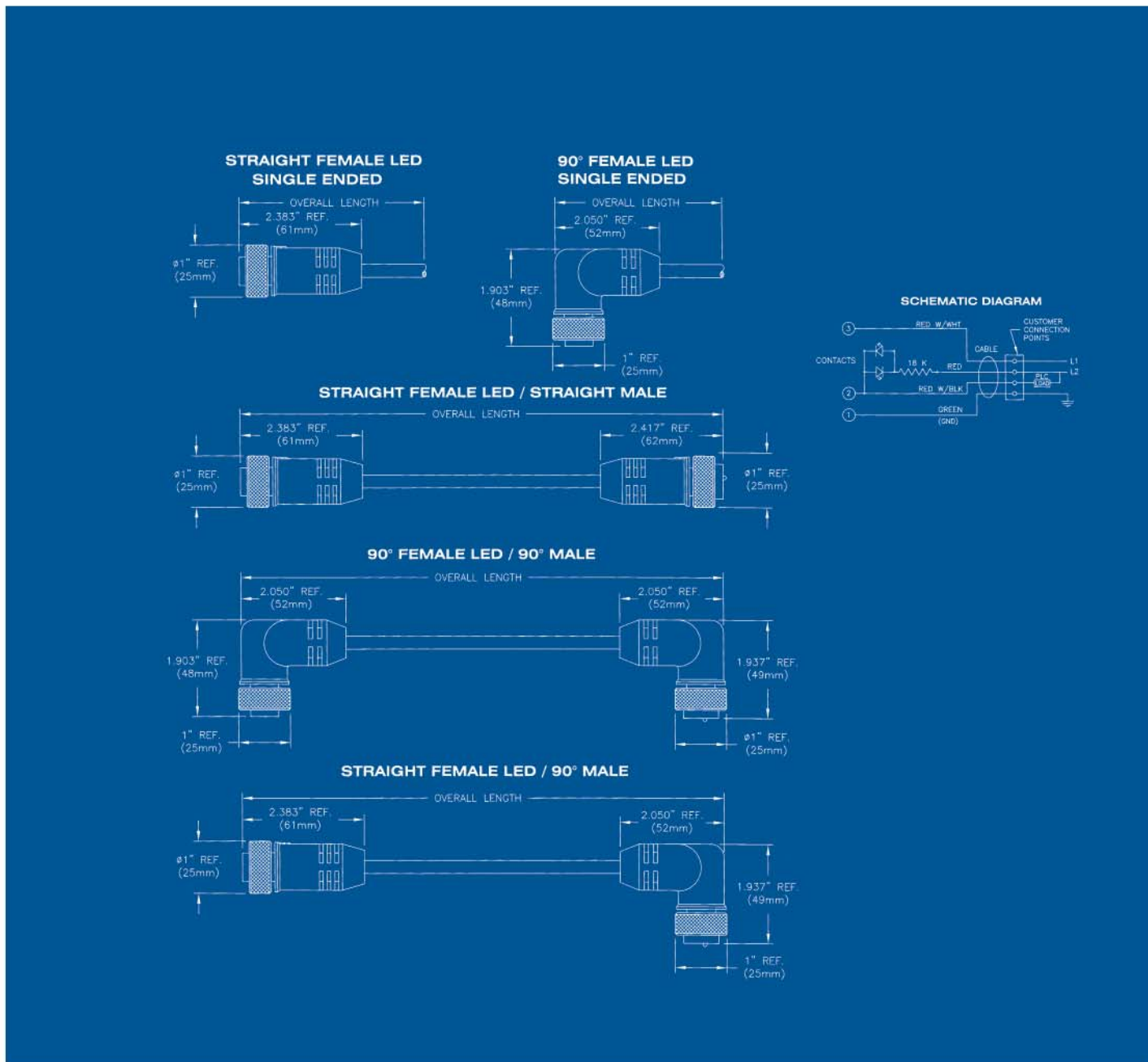

| Face View Female | Rating | Overall Length Inches | Straight Female LED Single Ended | 90° Female LED Single Ended | Straight Female LED / Straight Male* | 90° Female LED / 90° Male* | Straight Female LED / 90° Male* |
|------------------|--------|-----------------------|----------------------------------|-----------------------------|--------------------------------------|----------------------------|---------------------------------|
| | 3A | 36 | 163SL36 | 183SL36 | 563S4PL36 | 543S4PL36 | 553S4PL36 |
| | 120V | 72 | 163SL72 | 183SL72 | 563S4PL72 | 543S4PL72 | 553S4PL72 |
| | 144 | 144 | 163SL144 | 183SL144 | 563S4PL144 | 543S4PL144 | 553S4PL144 |
| | Custom | | 163SLXXXX | 183SLXXXX | 563S4PLXXXX | 543S4PLXXXX | 553S4PLXXXX |

*On side "B", the male insert has 4 positions.
XXXX – Indicates "overall length" in inches.
For mechanical and electrical specifications see pages 14 & 15.
90° assemblies have key position at 12 o'clock.

SENSOR-LINK MINI-MIZER®



MOLDED CONNECTOR ASSEMBLIES

STANDARD MINI-MIZER WIRING SEQUENCE

Panel Mounts and Cable Assemblies Conductor Color
Code per Contact Position:

INDUSTRIAL "A & C" Size

2 CONTACTS

- | | | |
|----|-----|--|
| 1. | WHT | |
| 2. | BLK | |

3 CONTACTS

- | | | |
|----|--------------|--|
| 1. | (GROUND) GRN | |
| 2. | BLK | |
| 3. | WHT | |

4 CONTACTS

- | | | |
|----|--------------|--|
| 1. | BLK | |
| 2. | WHT | |
| 3. | RED | |
| 4. | (GROUND) GRN | |

5 CONTACTS

- | | | |
|----|--------------|--|
| 1. | WHT | |
| 2. | RED | |
| 3. | (GROUND) GRN | |
| 4. | ORG | |
| 5. | BLK | |

6 CONTACTS

- | | | |
|----|--------------|--|
| 1. | WHT | |
| 2. | RED | |
| 3. | (GROUND) GRN | |
| 4. | ORG | |
| 5. | BLK | |
| 6. | BLU | |

9 CONTACTS

- | | | |
|----|--------------|--|
| 1. | ORG | |
| 2. | BLU | |
| 3. | RED/BLK | |
| 4. | GRN/BLK | |
| 5. | WHT | |
| 6. | RED | |
| 7. | (GROUND) GRN | |
| 8. | WHT/BLK | |
| 9. | BLK | |

10 CONTACTS

- | | | |
|-----|--------------|--|
| 1. | ORG | |
| 2. | BLU | |
| 3. | WHT/BLK | |
| 4. | RED/BLK | |
| 5. | GRN/BLK | |
| 6. | ORG/BLK | |
| 7. | RED | |
| 8. | (GROUND) GRN | |
| 9. | BLK | |
| 10. | WHT | |

12 CONTACTS

- | | | |
|-----|--------------|--|
| 1. | ORG | |
| 2. | BLU | |
| 3. | WHT/BLK | |
| 4. | RED/BLK | |
| 5. | GRN/BLK | |
| 6. | ORG/BLK | |
| 7. | BLU/BLK | |
| 8. | BLK/WHT | |
| 9. | (GROUND) GRN | |
| 10. | RED | |
| 11. | WHT | |
| 12. | BLK | |

19 CONTACTS

- | | | |
|-----|-------------------|--|
| 1. | VIO | |
| 2. | RED | |
| 3. | GRY | |
| 4. | RED/BLU | |
| 5. | BLU* | |
| 6. | GRN | |
| 7. | BRN* | |
| 8. | WHT/GRN | |
| 9. | WHT/YEL | |
| 10. | WHT/GRY | |
| 11. | BLK | |
| 12. | (GROUND) GRN/YEL* | |
| 13. | YEL/BRN | |
| 14. | BRN/GRN | |
| 15. | WHT | |
| 16. | YEL/BRN | |
| 17. | PNK | |
| 18. | GRY/BRN | |
| 19. | GRY/PNK | |

* 18 AWG wires
(other wires are 22 AWG)

AUTOMOTIVE "A" Size

3 CONTACTS

- | | | |
|----|--------------|--|
| 1. | (GROUND) GRN | |
| 2. | RED 2 | |
| 3. | RED 3 | |

4 CONTACTS

- | | | |
|----|--------------|--|
| 1. | RED 1 | |
| 2. | RED 2 | |
| 3. | RED 3 | |
| 4. | (GROUND) GRN | |

5 CONTACTS

- | | | |
|----|--------------|--|
| 1. | RED 1 | |
| 2. | RED 2 | |
| 3. | (GROUND) GRN | |
| 4. | RED 4 | |
| 5. | RED 5 | |

For Automotive Color Code Insert
"A" 164PA36

INTERNATIONAL "A" Size

2 CONTACTS

- | | | |
|----|-----|--|
| 1. | BRN | |
| 2. | BLU | |

3 CONTACTS

- | | | |
|----|-----|--|
| 1. | BLK | |
| 2. | BRN | |
| 3. | BLU | |

3 CONTACTS*

- | | | |
|----|---------|--|
| 1. | GRN/YEL | |
| 2. | BRN | |
| 3. | BLU | |

4 CONTACTS

- | | | |
|----|-----|--|
| 1. | BLK | |
| 2. | BLU | |
| 3. | BRN | |
| 4. | WHT | |

5 CONTACTS

- | | | |
|----|---------|--|
| 1. | BLK | |
| 2. | BLU | |
| 3. | GRN/YEL | |
| 4. | BRN | |
| 5. | WHT | |

For International Color Code Insert
"I" 164PI36

*For Second International Color
Code Use "IA" 164PIA36

SENSOR-LINK MINI-MIZER®

MOLDED CONNECTOR ASSEMBLIES

SENSOR LINK PRODUCT LINE

MINI-MIZER® SPECIFICATIONS

STANDARD PANEL MOUNTS:

- 16 AWG, 105C, 600V, PVC Hook-up Wire
- EPTR "Santoprene" Insert
- Lead Length 12 In.
- Epoxy Filled

STANDARD CABLE ASSEMBLIES:

- 16 AWG, PVC Yellow Jacketed Cable
- Insert Material
 - Polyurethane ("A" Size)
 - PVC ("C" Size)
- PVC Overmold
- Length 3, 6 and 12 Ft.
 - Options*
 - 16 AWG, Polyurethane Yellow Jacketed Cable
For Polyurethane Cable add suffix "U"
 - 16 AWG, PVC & Polyurethane Yellow Jacketed
Shielded Cable
For Shielded Cable add suffix "S"
- Lengths other than standard
- DeviceNet Gray
 - Add suffix "D1": Thin
 - Add suffix "D2": Thick

Y SPLITTER ASSEMBLIES:

- 18 AWG, Polyurethane Yellow Jacketed Cable
- Polyurethane Insert
- Polyurethane Overmold

TRI CONNECTOR:

- 18 AWG Hook-up Wires
- Polyurethane Insert
- Polyurethane Overmold
 - Options*
 - DeviceNet Gray
 - Add suffix "D1": Thin
 - Add suffix "D2": Thick

DUAL CONNECTOR WITH CABLE:

- 18 AWG, Polyurethane Yellow Jacketed Cable
- Polyurethane Insert
- Polyurethane Overmold

TERMINATOR:

- Resistor 1/4 Watt 121 Ohm 1%
- Polyurethane Insert
- Polyurethane Overmold

LED CORDSET:

- 2 High Intensity (700-1,000 mcd) Extended Life Yellow LEDs. (Typical life @ ambient temperature is 100,000 hours)
- 18 AWG, PVC Yellow Jacketed Cable
- PVC Insert
- PVC, Clear Overmold (LED Side Only)
 - Options*
 - 18 AWG, Polyurethane Yellow Jacketed Cable
 - Polyurethane, Clear Overmold (LED Side Only)

**SENSOR LINK
PRODUCT LINE**

MINI-MIZER[®] SPECIFICATIONS

ELECTRICAL RATING:

VOLTAGE: 600V (NON-LED ASSEMBLIES)
120V (LED ASSEMBLIES)

CABLE ASSEMBLIES:

COUPLING NUT: Anodized Aluminum (Optional Nylon and Stainless Steel) Consult Factory

CONTACTS: Copper Alloy, Gold-plated

INSERT: Polyurethane ("A" Size)
PVC ("C" Size)

MOLDED HEADS: PVC or PUR per Cable Jacket Material

CABLE: 16 AWG: PVC Insulated, Fine Stranded Copper Conductors, Yellow Oil Resistant PVC Jacketed
600V, STO, 105°C.
18 AWG, 300V, 105°C for Y-splitter & Dual Connector with Cable
UL Recognized, CSA Certified

PANEL MOUNT ASSEMBLIES:

SHELLS: Anodized Aluminum (Optional Nylon and Stainless Steel) Consult Factory

CONTACTS: Copper Alloy, Gold-plated

INSERTS: Ethylene Propylene
Thermoplastic Rubber
"Santoprene"

WIRE: 16 AWG PVC Insulated, 600V
UL Recognized, CSA Certified

ENVIRONMENTAL:

PROTECTION: NEMA 6P, IP67 & IP68

OPERATING AMBIENT: -20° to 80°C

CERTIFICATIONS:

UL: UL Recognized, File No. E150822

CSA: CSA Certified, FILE No. 181200

EMI/RFI SHIELDING:

Meets or Exceeds IEC Directives:

IEC 1000-4-2 ESD, 5KV to 15KV in 2.5KV Steps
IEC 1000-4-3 RFI Immunity, 10V/m
IEC 1000-4-4 Fast Transient, 2K
IEC 1000-4-5 Surge, DC Immunity, 3.1KV
EN50141 Induced RF Immunity, 10V/m



* Please visit the product pages on our website for the most up-to-date product information

SENSOR-LINK AC METAL MICRO-MIZER®

MOLDED CONNECTOR ASSEMBLIES



Anti-vibration coupling nuts standard.

| Face View Male | Rating | Overall Length Inches | Straight Male Single Ended | Straight Female Single Ended | 90° Male Single Ended | 90° Female Single Ended |
|----------------|------------|-----------------------|----------------------------|------------------------------|-----------------------|-------------------------|
| | 3A 300V | 36 | 402P36 | 402S36 | 462P36 | 462S36 |
| | | 72 | 402P72 | 402S72 | 462P72 | 462S72 |
| | | 144 | 402P144 | 402S144 | 462P144 | 462S144 |
| | | Custom | 402PXXXX | 402SXXXX | 462PXXXX | 462SXXXX |
| | 3A 300V | 36 | 403P36 | 403S36 | 463P36 | 463S36 |
| | | 72 | 403P72 | 403S72 | 463P72 | 463S72 |
| | | 144 | 403P144 | 403S144 | 463P144 | 463S144 |
| | | Custom | 403PXXXX | 403SXXXX | 463PXXXX | 463SXXXX |
| | 3A 300V | 36 | 404P36 | 404S36 | 464P36 | 464S36 |
| | | 72 | 404P72 | 404S72 | 464P72 | 464S72 |
| | | 144 | 404P144 | 404S144 | 464P144 | 464S144 |
| | | Custom | 404PXXXX | 404SXXXX | 464PXXXX | 464SXXXX |
| | 3A 300V | 36 | 405P36 | 405S36 | 465P36 | 465S36 |
| | | 72 | 405P72 | 405S72 | 465P72 | 465S72 |
| | | 144 | 405P144 | 405S144 | 465P144 | 465S144 |
| | | Custom | 405PXXXX | 405SXXXX | 465PXXXX | 465SXXXX |
| | 3A 300V | 36 | 406P36 | 406S36 | 466P36 | 466S36 |
| | | 72 | 406P72 | 406S72 | 466P72 | 466S72 |
| | | 144 | 406P144 | 406S144 | 466P144 | 466S144 |
| | | Custom | 406PXXXX | 406SXXXX | 466PXXXX | 466SXXXX |

XXXX – Indicates “overall length” in inches.

For mechanical, electrical and wiring sequence see pages 28 & 29.

90° assemblies have major key position at 6 o'clock (in line with the cable).



Anti-vibration coupling nuts standard.

| Receptacle Male 1/4 - 18 NPT 12 Inch Leads | Receptacle Female 12 Inch Leads | Receptacle Male 1/2 - 14 NPT 12 Inch Leads | Straight Male /Male Double Ended | Straight Female /Female Double Ended | Straight Male /Female Double Ended |
|--|------------------------------------|--|-------------------------------------|---|---------------------------------------|
| 412P12 | 412S12 | 412PA12 | 472P2P36 | 472S2S36 | 472P2S36 |
| | | | 472P2P72 | 472S2S72 | 472P2S72 |
| | | | 472P2P144 | 472S2S144 | 472P2S144 |
| 412PXXX | 412SXXX | 412PAXXX | 472P2PXXXX | 472S2SXXXX | 472P2SXXXX |
| | | | 473P3P36 | 473S3S36 | 473P3S36 |
| | | | 473P3P72 | 473S3S72 | 473P3S72 |
| | | | 473P3P144 | 473S3S144 | 473P3S144 |
| 413PXXX | 413SXXX | 413PAXXX | 473P3PXXXX | 473S3SXXXX | 473P3SXXXX |
| | | | 474P4P36 | 474S4S36 | 474P4S36 |
| | | | 474P4P72 | 474S4S72 | 474P4S72 |
| | | | 474P4P144 | 474S4S144 | 474P4S144 |
| 414PXXX | 414SXXX | 414PAXXX | 474P4PXXXX | 474S4SXXXX | 474P4SXXXX |
| | | | 475P5P36 | 475S5S36 | 475P5S36 |
| | | | 475P5P72 | 475S5S72 | 475P5S72 |
| | | | 475P5P144 | 475S5S144 | 475P5S144 |
| 415PXXX | 415SXXX | 415PAXXX | 475P5PXXXX | 475S5SXXXX | 475P5SXXXX |
| | | | 476P6P36 | 476S6S36 | 476P6S36 |
| | | | 476P6P72 | 476S6S72 | 476P6S72 |
| | | | 476P6P144 | 476S6S144 | 476P6S144 |
| 416PXXX | 416SXXX | 416PAXXX | 476P6PXXXX | 476S6SXXXX | 476P6SXXXX |

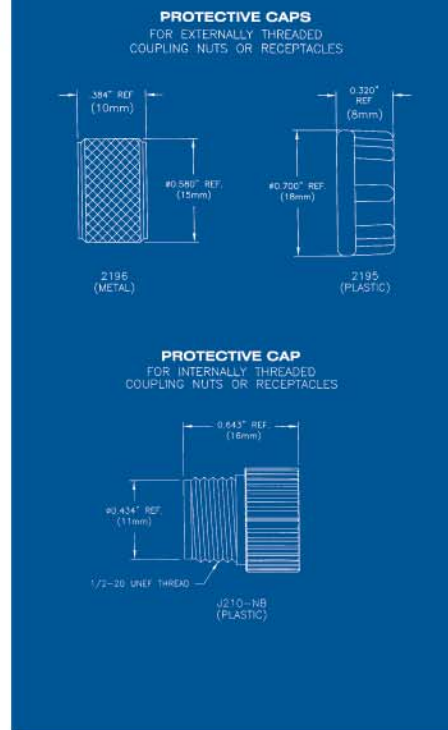

XXXX - Indicates "overall length / lead length" in inches.
For mechanical, electrical and wiring sequence see pages 28 & 29.

* Please visit the product pages on our website for the most up-to-date product information

SENSOR-LINK AC METAL MICRO-MIZER®

MOLDED CONNECTOR ASSEMBLIES



Anti-vibration coupling nuts standard.

| Face View Male | Rating | Overall Length Inches | 90° Male / Male Double Ended | 90° Female / Female Double Ended | 90° Male / Female Double Ended | Straight to 90° Male / Female Double Ended | Straight to 90° Female / Male Double Ended |
|----------------|------------|-----------------------|------------------------------|----------------------------------|--------------------------------|--|--|
| | 3A 300V | 36 | 452P2P36 | 452S2S36 | 452P2S36 | 482P2S36 | 482S2P36 |
| | | 72 | 452P2P72 | 452S2S72 | 452P2S72 | 482P2S72 | 482S2P72 |
| | | 144 | 452P2P144 | 452S2S144 | 452P2S144 | 482P2S144 | 482S2P144 |
| | | Custom | 452P2PXXXX | 452S2SXXXX | 452P2SXXXX | 482P2SXXXX | 482S2PXXXX |
| | 3A 300V | 36 | 453P3P36 | 453S3S36 | 453P3S36 | 483P3S36 | 483S3P36 |
| | | 72 | 453P3P72 | 453S3S72 | 453P3S72 | 483P3S72 | 483S3P72 |
| | | 144 | 453P3P144 | 453S3S144 | 453P3S144 | 483P3S144 | 483S3P144 |
| | | Custom | 453P3PXXXX | 453S3SXXXX | 453P3SXXXX | 483P3SXXXX | 483S3PXXXX |
| | 3A 300V | 36 | 454P4P36 | 454S4S36 | 454P4S36 | 484P4S36 | 484S4P36 |
| | | 72 | 454P4P72 | 454S4S72 | 454P4S72 | 484P4S72 | 484S4P72 |
| | | 144 | 454P4P144 | 454S4S144 | 454P4S144 | 484P4S144 | 484S4P144 |
| | | Custom | 454P4PXXXX | 454S4SXXXX | 454P4SXXXX | 484P4SXXXX | 484S4PXXXX |
| | 3A 300V | 36 | 455P5P36 | 455S5S36 | 455P5S36 | 485P5S36 | 485S5P36 |
| | | 72 | 455P5P72 | 455S5S72 | 455P5S72 | 485P5S72 | 485S5P72 |
| | | 144 | 455P5P144 | 455S5S144 | 455P5S144 | 485P5S144 | 485S5P144 |
| | | Custom | 455P5PXXXX | 455S5SXXXX | 455P5SXXXX | 485P5SXXXX | 485S5PXXXX |
| | 3A 300V | 36 | 456P6P36 | 456S6S36 | 456P6S36 | 486P6S36 | 486S6P36 |
| | | 72 | 456P6P72 | 456S6S72 | 456P6S72 | 486P6S72 | 486S6P72 |
| | | 144 | 456P6P144 | 456S6S144 | 456P6S144 | 486P6S144 | 486S6P144 |
| | | Custom | 456P6PXXXX | 456S6SXXXX | 456P6SXXXX | 486P6SXXXX | 486S6PXXXX |

XXXX – Indicates “overall length” in inches.

For mechanical, electrical and wiring sequence see pages 28 & 29.

90° assemblies have major key position at 6 o'clock (in line with the cable).

* Please visit the product pages on our website for the most up-to-date product information

SENSOR-LINK AC METAL MICRO-MIZER®



MOLDED CONNECTOR ASSEMBLIES

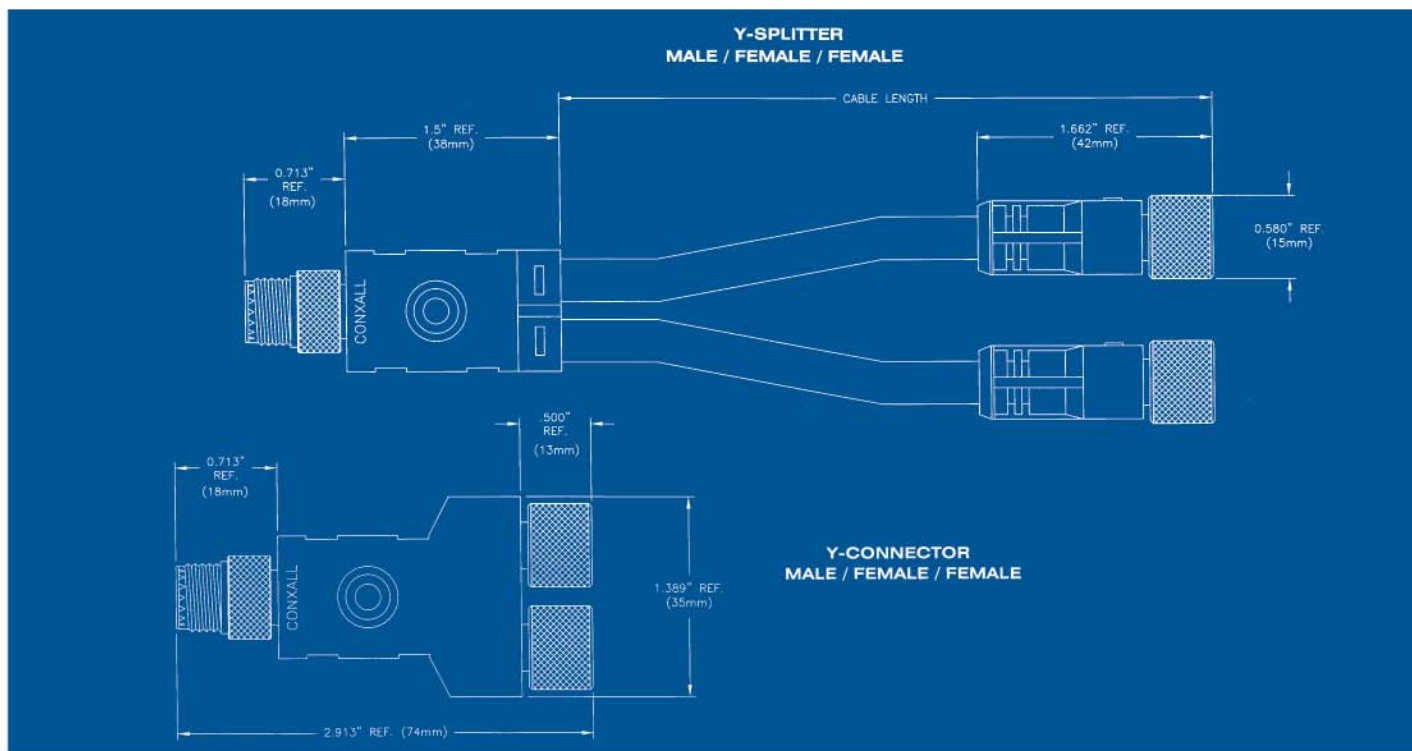

Anti-vibration coupling nuts standard.

| Face View Male | Rating | Wiring Diagram | Y-Splitter Female / Female Female | Y-Splitter Male / Female Female | Y-Connector Female / Female Female | Y-Connector Male / Female Female |
|----------------|------------|----------------|-----------------------------------|---------------------------------|------------------------------------|----------------------------------|
| | 3A 300V | | 492S2S2S12 492S2S2SXXX | 492P2S2S12 492P2S2SXXX | 422S2S2S | 422P2S2S |
| | 3A 300V | | 493S3S3S12 493S3S3SXXX | 493P3S3S12 493P3S3SXXX | 423S3S3S | 423P3S3S |
| | 3A 300V | | 494S4S4S12 494S4S4SXXX | 494P4S4S12 494P4S4SXXX | 424S4S4S | 424P4S4S |
| | 3A 300V | | 495S5S5S12 495S5S5SXXX | 495P5S5S12 495P5S5SXXX | 425S5S5S | 425P5S5S |
| | 3A 300V | | 496S6S6S12 496S6S6SXXX | 496P6S6S12 496P6S6SXXX | 426S6S6S | 426P6S6S |

XXX – Indicates “cable length” in inches, other than standard 12 inch length.
For mechanical, electrical and wiring sequence see pages 28 & 29.
For insert combinations not shown — consult factory.



* Please visit the product pages on our website for the most up-to-date product information

SENSOR-LINK DC METAL MICRO-MIZER®

MOLDED CONNECTOR ASSEMBLIES



Anti-vibration coupling nuts standard.

| Face View Male | Rating | Overall Length Meters | Straight Male Single Ended | Straight Female Single Ended | 90° Male Single Ended | 90° Female Single Ended |
|----------------|------------|-----------------------|----------------------------|------------------------------|-----------------------|-------------------------|
| | 3A 300V | 1 | 302P1 | 302S1 | 342P1 | 342S1 |
| | | 2 | 302P2 | 302S2 | 342P2 | 342S2 |
| | | 4 | 302P4 | 302S4 | 342P4 | 342S4 |
| | | Custom | 302PXX | 302SXX | 342PXX | 342SXX |
| | 3A 300V | 1 | 303P1 | 303S1 | 343P1 | 343S1 |
| | | 2 | 303P2 | 303S2 | 343P2 | 343S2 |
| | | 4 | 303P4 | 303S4 | 343P4 | 343S4 |
| | | Custom | 303PXX | 303SXX | 343PXX | 343SXX |
| | 3A 300V | 1 | 304P1 | 304S1 | 344P1 | 344S1 |
| | | 2 | 304P2 | 304S2 | 344P2 | 344S2 |
| | | 4 | 304P4 | 304S4 | 344P4 | 344S4 |
| | | Custom | 304PXX | 304SXX | 344PXX | 344SXX |
| | 3A 300V | 1 | 305P1 | 305S1 | 345P1 | 345S1 |
| | | 2 | 305P2 | 305S2 | 345P2 | 345S2 |
| | | 4 | 305P4 | 305S4 | 345P4 | 345S4 |
| | | Custom | 305PXX | 305SXX | 345PXX | 345SXX |
| | 2A 125V | 1 | 308P1 | 308S1 | 348P1 | 348S1 |
| | | 2 | 308P2 | 308S2 | 348P2 | 348S2 |
| | | 4 | 308P4 | 308S4 | 348P4 | 348S4 |
| | | Custom | 308PXX | 308SXX | 348PXX | 348SXX |

Consult Factory for 6 & 7 Pole

XX - Indicates "overall length" in meters.
 For mechanical, electrical and wiring sequence see pages 28 & 29.
 90° assemblies have key position at 45 degrees.



Anti-vibration coupling nuts standard.

| Receptacle Male 1/4 - 18 NPT .3 Meter Leads | Receptacle Female .3 Meter Leads | Receptacle Male 1/2 - 14 NPT .3 Meter Leads | Straight Male / Male Double Ended | Straight Female / Female Double Ended | Straight Male / Female Double Ended |
|---|-------------------------------------|---|--------------------------------------|--|--|
| 312P.3 | 312S.3 | 312PA.3 | 372P2P1 | 372S2S1 | 372P2S1 |
| | | | 372P2P2 | 372S2S2 | 372P2S2 |
| | | | 372P2P4 | 372S2S4 | 372P2S4 |
| 312PXX | 312SXX | 312PAXX | 372P2PXX | 372S2SXX | 372P2SXX |
| | | | 373P3P1 | 373S3S1 | 373P3S1 |
| | | | 373P3P2 | 373S3S2 | 373P3S2 |
| | | | 373P3P4 | 373S3S4 | 373P3S4 |
| 313PXX | 313SXX | 313PAXX | 373P3PXX | 373S3SXX | 373P3SXX |
| | | | 374P4P1 | 374S4S1 | 374P4S1 |
| | | | 374P4P2 | 374S4S2 | 374P4S2 |
| | | | 374P4P4 | 374S4S4 | 374P4S4 |
| 314PXX | 314SXX | 314PAXX | 374P4PXX | 374S4SXX | 374P4SXX |
| | | | 375P5P1 | 375S5S1 | 375P5S1 |
| | | | 375P5P2 | 375S5S2 | 375P5S2 |
| | | | 375P5P4 | 375S5S4 | 375P5S4 |
| 315PXX | 315SXX | 315PAXX | 375P5PXX | 375S5SXX | 375P5SXX |
| | | | 378P8P1 | 378S8S1 | 378P8S1 |
| | | | 378P8P2 | 378S8S2 | 378P8S2 |
| | | | 378P8P4 | 378S8S4 | 378P8S4 |
| 318PXX | 318SXX | 318PAXX | 378P8PXX | 378S8SXX | 378P8SXX |

PROTECTIVE CAPS
FOR EXTERNALLY THREADED
COUPLING NUTS OR RECEPTACLES

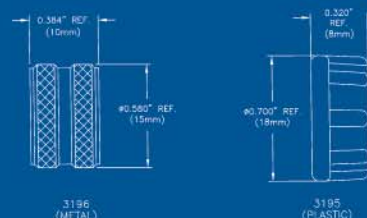

PROTECTIVE CAP
FOR INTERNALLY THREADED
COUPLING NUTS OR RECEPTACLES

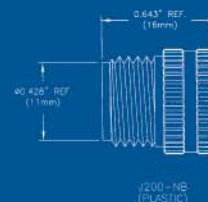

XX - Indicates "overall length / lead length" in meters.
For mechanical, electrical and wiring sequence see pages 28 & 29.

SENSOR-LINK DC METAL MICRO-MIZER®

MOLDED CONNECTOR ASSEMBLIES



Anti-vibration coupling nuts standard.

| Face View Male | Rating | Overall Length Meters | 90° Male/Male Double Ended | 90° Female/Female Double Ended | 90° Male/Female Double Ended | Straight to 90° Male/Female Double Ended | Straight to 90° Female/Male Double Ended |
|----------------|------------|-----------------------|----------------------------|--------------------------------|------------------------------|--|--|
| | 3A 300V | 1 | 362P2P1 | 362S2S1 | 362P2S1 | 352P2S1 | 352S2P1 |
| | | 2 | 362P2P2 | 362S2S2 | 362P2S2 | 352P2S2 | 352S2P2 |
| | | 4 | 362P2P4 | 362S2S4 | 362P2S4 | 352P2S4 | 352S2P4 |
| | | Custom | 362P2PXX | 362S2SXX | 362P2SXX | 352P2SXX | 352S2PXX |
| | 3A 300V | 1 | 363P3P1 | 363S3S1 | 363P3S1 | 353P3S1 | 353S3P1 |
| | | 2 | 363P3P2 | 363S3S2 | 363P3S2 | 353P3S2 | 353S3P2 |
| | | 4 | 363P3P4 | 363S3S4 | 363P3S4 | 353P3S4 | 353S3P4 |
| | | Custom | 363P3PXX | 363S3SXX | 363P3SXX | 353P3SXX | 353S3PXX |
| | 3A 300V | 1 | 364P4P1 | 364S4S1 | 364P4S1 | 354P4S1 | 354S4P1 |
| | | 2 | 364P4P2 | 364S4S2 | 364P4S2 | 354P4S2 | 354S4P2 |
| | | 4 | 364P4P4 | 364S4S4 | 364P4S4 | 354P4S4 | 354S4P4 |
| | | Custom | 364P4PXX | 364S4SXX | 364P4SXX | 354P4SXX | 354S4PXX |
| | 3A 300V | 1 | 365P5P1 | 365S5S1 | 365P5S1 | 355P5S1 | 355S5P1 |
| | | 2 | 365P5P2 | 365S5S2 | 365P5S2 | 355P5S2 | 355S5P2 |
| | | 4 | 365P5P4 | 365S5S4 | 365P5S4 | 355P5S4 | 355S5P4 |
| | | Custom | 365P5PXX | 365S5SXX | 365P5SXX | 355P5SXX | 355S5PXX |
| | 2A 125V | 1 | 368P8P1 | 368S8S1 | 368P8S1 | 358P8S1 | 358S8P1 |
| | | 2 | 368P8P2 | 368S8S2 | 368P8S2 | 358P8S2 | 358S8P2 |
| | | 4 | 368P8P4 | 368S8S4 | 368P8S4 | 358P8S4 | 358S8P4 |
| | | Custom | 368P8PXX | 368S8SXX | 368P8SXX | 358P8SXX | 358S8PXX |

Consult Factory for 6 & 7 Pole

XX – Indicates “overall length” in meters.
For mechanical, electrical and wiring sequence see pages 28 & 29.
90° assemblies have key position at 45 degrees.

* Please visit the product pages on our website for the most up-to-date product information

SENSOR-LINK DC METAL MICRO-MIZER®



MOLDED CONNECTOR ASSEMBLIES



Anti-vibration coupling nuts standard.

| Face View Male | Rating | Wiring Diagram | Y-Splitter Female / Female Female | Y-Splitter Male / Female Female | Y-Connector Female / Female Female | Y-Connector Male / Female Female |
|----------------|------------|----------------|-----------------------------------|---------------------------------|------------------------------------|----------------------------------|
| | 3A 300V | | 392S2S2S.3 392S2S2SXX | 392P2S2S.3 392P2S2SXX | 322S2S2S | 322P2S2S |
| | 3A 300V | | 393S3S3S.3 393S3S3SXX | 393P3S3S.3 393P3S3SXX | 323S3S3S | 323P3S3S |
| | 3A 300V | | 394S4S4S.3 394S4S4SXX | 394P4S4S.3 394P4S4SXX | 324S4S4S | 324P4S4S |
| | 3A 300V | | 395S5S5S.3 395S5S5SXX | 395P5S5S.3 395P5S5SXX | 325S5S5S | 325P5S5S |
| | 2A 125V | | 398S8S8S.3 398S8S8SXX | 398P8S8S.3 398P8S8SXX | 328S8S8S | 328P8S8S |

Consult Factory for 6 & 7 Pole

XX – Indicates “cable length” in meters, other than standard .3 meter length.
For mechanical, electrical and wiring sequence see pages 28 & 29.
For insert combinations not shown — consult factory.

* Please visit the product pages on our website for the most up-to-date product information

SINGLE KEY PLASTIC MICRO-MIZER®

MOLDED CONNECTOR ASSEMBLIES

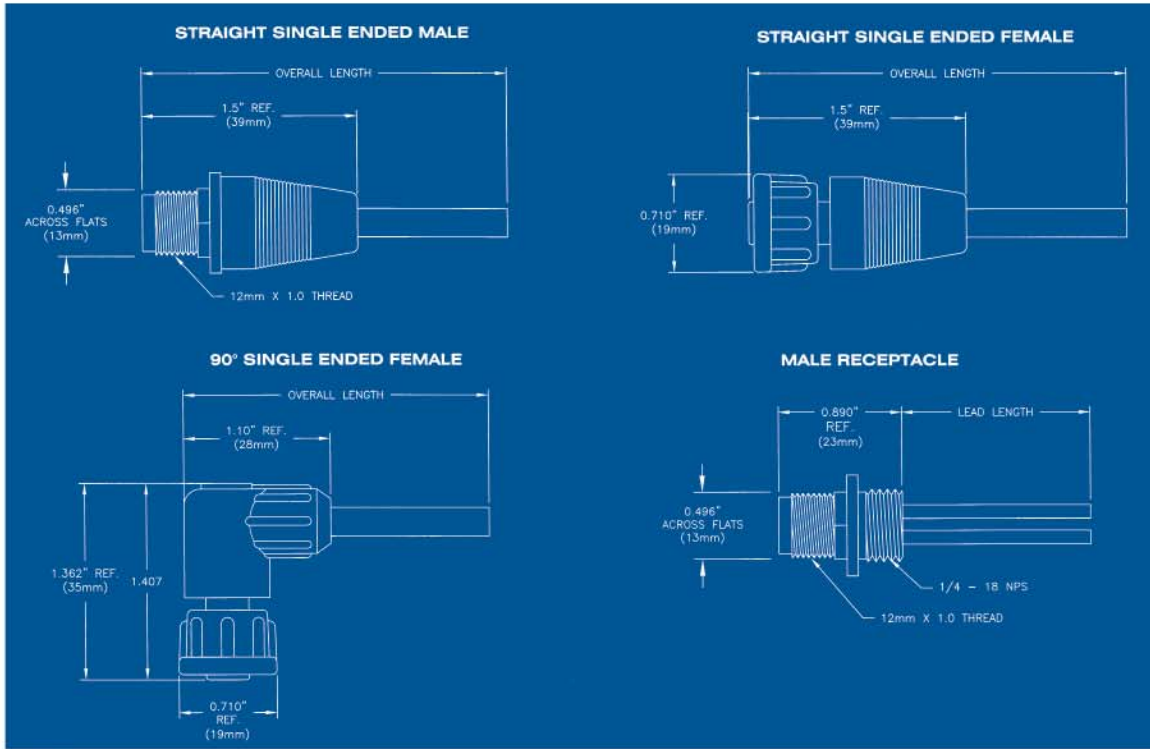

| Face View Male | Rating | Overall Length Meters | Straight Male Single Ended | Straight Female Single Ended | 90° Female Single Ended | Receptacle Male .3 Meter Leads |
|----------------|------------|-----------------------|----------------------------|------------------------------|-------------------------|--------------------------------|
| | 3A 300V | 1 | 202P1 | 202S1 | 232S1 | 212P.3 |
| | | 2 | 202P2 | 202S2 | 232S2 | |
| | | 4 | 202P4 | 202S4 | 232S4 | |
| | | Custom | 202PXX | 202SXX | 232SXX | |
| | 3A 300V | 1 | 203P1 | 203S1 | 233S1 | 213P.3 |
| | | 2 | 203P2 | 203S2 | 233S2 | |
| | | 4 | 203P4 | 203S4 | 233S4 | |
| | | Custom | 203PXX | 203SXX | 233SXX | |
| | 3A 300V | 1 | 204P1 | 204S1 | 234S1 | 214P.3 |
| | | 2 | 204P2 | 204S2 | 234S2 | |
| | | 4 | 204P4 | 204S4 | 234S4 | |
| | | Custom | 204PXX | 204SXX | 234SXX | |
| | 3A 300V | 1 | 205P1 | 205S1 | 235S1 | 215P.3 |
| | | 2 | 205P2 | 205S2 | 235S2 | |
| | | 4 | 205P4 | 205S4 | 235S4 | |
| | | Custom | 205PXX | 205SXX | 235SXX | |

XX - Indicates "overall length / lead length" in meters.
 For mechanical, electrical and wiring sequence see pages 28 & 29.



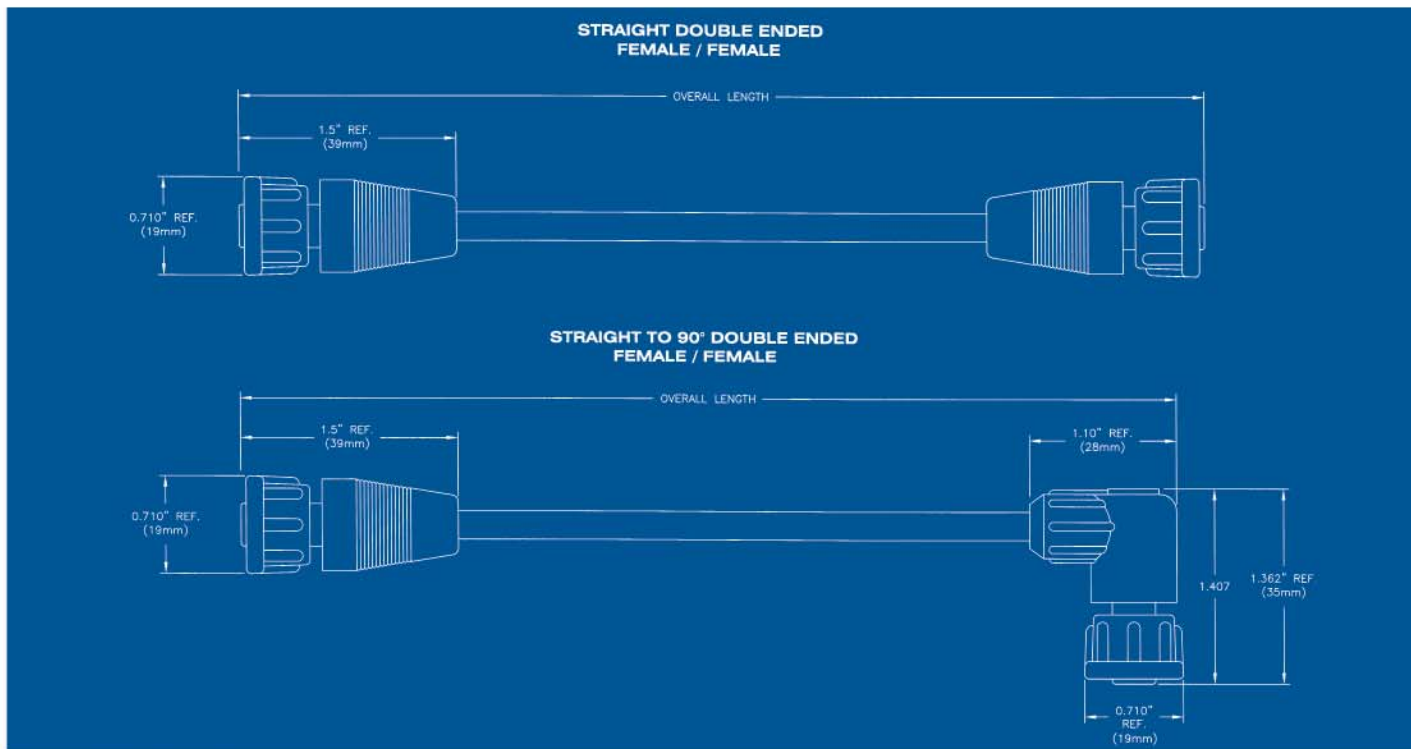

See page 19 for Sealing Covers.

| Straight Female / Female Double Ended | Straight Male / Female Double Ended | Straight Male / Male Double Ended | 90° Female / Female Double Ended | Straight to 90° Female / Female Double Ended | Straight to 90° Male / Female Double Ended |
|---------------------------------------|-------------------------------------|-----------------------------------|----------------------------------|--|--|
| 242S2S1 | 242P2S1 | 242P2P1 | 262S2S1 | 272S2S1 | 272P2S1 |
| 242S2S2 | 242P2S2 | 242P2P2 | 262S2S2 | 272S2S2 | 272P2S2 |
| 242S2S4 | 242P2S4 | 242P2P4 | 262S2S4 | 272S2S4 | 272P2S4 |
| 242S2SXX | 242P2SXX | 242P2PXX | 262S2SXX | 272S2SXX | 272P2SXX |
| 243S3S1 | 243P3S1 | 243P3P1 | 263S3S1 | 273S3S1 | 273P3S1 |
| 243S3S2 | 243P3S2 | 243P3P2 | 263S3S2 | 273S3S2 | 273P3S2 |
| 243S3S4 | 243P3S4 | 243P3P4 | 263S3S4 | 273S3S4 | 273P3S4 |
| 243S3SXX | 243P3SXX | 243P3PXX | 263S3SXX | 273S3SXX | 273P3SXX |
| 244S4S1 | 244P4S1 | 244P4P1 | 264S4S1 | 274S4S1 | 274P4S1 |
| 244S4S2 | 244P4S2 | 244P4P2 | 264S4S2 | 274S4S2 | 274P4S2 |
| 244S4S4 | 244P4S4 | 244P4P4 | 264S4S4 | 274S4S4 | 274P4S4 |
| 244S4SXX | 244P4SXX | 244P4PXX | 264S4SXX | 274S4SXX | 274P4SXX |
| 245S5S1 | 245P5S1 | 245P5P1 | 265S5S1 | 275S5S1 | 275P5S1 |
| 245S5S2 | 245P5S2 | 245P5P2 | 265S5S2 | 275S5S2 | 275P5S2 |
| 245S5S4 | 245P5S4 | 245P5P4 | 265S5S4 | 275S5S4 | 275P5S4 |
| 245S5SXX | 245P5SXX | 245P5PXX | 265S5SXX | 275S5SXX | 275P5SXX |

XX – Indicates “overall length” in meters.
 For mechanical, electrical and wiring sequence see pages 28 & 29.

SENSOR-LINK DC METAL MICRO-MIZER[®] EMI/RFI SHIELDED MOLDED CONNECTOR ASSEMBLIES



| Face View Male | Rating | Overall Length Meters | Straight Inline Male Single Ended | Straight Female Single Ended | Straight Inline Male Double Ended | Straight Female/Female Double Ended | Straight Male/Female Double Ended | Receptacle Male .3 Meter Leads |
|----------------|------------|-----------------------|-----------------------------------|------------------------------|-----------------------------------|-------------------------------------|-----------------------------------|--------------------------------|
| | 3A 300V | 1 | SH302P*1 | SH302S1 | SH372P2P*1 | SH372S2S1 | SH372P2S*1 | SH312P.3 |
| | | 2 | SH302P*2 | SH302S2 | SH372P2P*2 | SH372S2S2 | SH372P2S*2 | |
| | | 4 | SH302P*4 | SH302S4 | SH372P2P*4 | SH372S2S4 | SH372P2S*4 | |
| | | Custom | SH302P*XX | SH302SXX | SH372P2P*XX | SH372S2SXX | SH372P2S*XX | |
| | 3A 300V | 1 | SH303P*1 | SH303S1 | SH373P3P*1 | SH373S3S1 | SH373P3S*1 | SH313P.3 |
| | | 2 | SH303P*2 | SH303S2 | SH373P3P*2 | SH373S3S2 | SH373P3S*2 | |
| | | 4 | SH303P*4 | SH303S4 | SH373P3P*4 | SH373S3S4 | SH373P3S*4 | |
| | | Custom | SH303P*XX | SH303SXX | SH373P3P*XX | SH373S3SXX | SH373P3S*XX | |
| | 3A 300V | 1 | SH304P*1 | SH304S1 | SH374P4P*1 | SH374S4S1 | SH374P4S*1 | SH314P.3 |
| | | 2 | SH304P*2 | SH304S2 | SH374P4P*2 | SH374S4S2 | SH374P4S*2 | |
| | | 4 | SH304P*4 | SH304S4 | SH374P4P*4 | SH374S4S4 | SH374P4S*4 | |
| | | Custom | SH304P*XX | SH304SXX | SH374P4P*XX | SH374S4SXX | SH374P4S*XX | |
| | 3A 300V | 1 | SH305P*1 | SH305S1 | SH375P5P*1 | SH375S5S1 | SH375P5S*1 | SH315P.3 |
| | | 2 | SH305P*2 | SH305S2 | SH375P5P*2 | SH375S5S2 | SH375P5S*2 | |
| | | 4 | SH305P*4 | SH305S4 | SH375P5P*4 | SH375S5S4 | SH375P5S*4 | |
| | | Custom | SH305P*XX | SH305SXX | SH375P5P*XX | SH375S5SXX | SH375P5S*XX | |
| | 2A 125V | 1 | SH308P*1 | SH308S1 | SH378P8P*1 | SH378S8S1 | SH378P8S*1 | SH318P.3 |
| | | 2 | SH308P*2 | SH308S2 | SH378P8P*2 | SH378S8S2 | SH378P8S*2 | |
| | | 4 | SH308P*4 | SH308S4 | SH378P8P*4 | SH378S8S4 | SH378P8S*4 | |
| | | Custom | SH308P*XX | SH308SXX | SH378P8P*XX | SH378S8SXX | SH378P8S*XX | |

Consult Factory for 6 & 7 Pole

XX – Indicates “overall length” in meters.
For mechanical, electrical and wiring sequence see pages 28 & 29.
* Insert an “R” for Rotating Male Coupling Nut. (Blank is standard for fixed nut.)

* Please visit the product pages on our website for the most up-to-date product information

SENSOR-LINK[®]

DC METAL MICRO-MIZER[®] LED CORDSETS

MOLDED CONNECTOR ASSEMBLIES



| Face View Female | Circuit Type | Rating | Overall Length Meters | Straight Inline Male Single Ended | Straight Female Single Ended | Straight Inline Male Double Ended | Straight Female/Female Double Ended | Straight Male/Female Double Ended |
|------------------|--------------|--------------------|-----------------------|-----------------------------------|------------------------------|-----------------------------------|-------------------------------------|-----------------------------------|
| | PNP | 3A 10 to 30V DC | 1 | 303SL1PNP | 343SL1PNP | 373S4PL1PNP | 363S4PL1PNP | 353S4PL1PNP |
| | | | 2 | 303SL2PNP | 343SL2PNP | 373S4PL2PNP | 363S4PL2PNP | 353S4PL2PNP |
| | | | 4 | 303SL4PNP | 343SL4PNP | 373S4PL4PNP | 363S4PL4PNP | 353S4PL4PNP |
| | | | Custom | 303SLXXPNP | 343SLXXPNP | 373S4PLXXPNP | 363S4PLXXPNP | 353S4PLXXPNP |
| | NPN | 3A 10 to 30V DC | 1 | 303SL1NPN | 343SL1NPN | 373S4PL1NPN | 363S4PL1NPN | 353S4PL1NPN |
| | | | 2 | 303SL2NPN | 343SL2NPN | 373S4PL2NPN | 363S4PL2NPN | 353S4PL2NPN |
| | | | 4 | 303SL4NPN | 343SL4NPN | 373S4PL4NPN | 363S4PL4NPN | 353S4PL4NPN |
| | | | Custom | 303SLXXNPN | 343SLXXNPN | 373S4PLXXNPN | 363S4PLXXNPN | 353S4PLXXNPN |

XX – Indicates “overall length” in meters.
 Note: Only three of the four positions of the insert are being utilized. Position 2 is a “dummy” contact.
 For mechanical and electrical specifications see pages 28 & 29.
 90° assemblies have key position at 45 degrees.

SENSOR-LINK MICRO-MIZER®

MOLDED CONNECTOR ASSEMBLIES

STANDARD MINI-MIZER WIRING SEQUENCE

Panel Mounts and Cable Assemblies Conductor
Color Code per Contact Position:

DC

2 CONTACTS

| | | |
|----|-----|--|
| 3. | BRN | |
| 4. | BLU | |

3 CONTACTS

| | | |
|----|-----|--|
| 1. | BRN | |
| 3. | BLU | |
| 4. | BLK | |

4 CONTACTS

| | | |
|----|-----|--|
| 1. | BRN | |
| 2. | WHT | |
| 3. | BLU | |
| 4. | BLK | |

5 CONTACTS

| | | |
|----|-----|--|
| 1. | BRN | |
| 2. | WHT | |
| 3. | BLU | |
| 4. | BLK | |
| 5. | GRY | |

8 CONTACTS

| | | |
|----|------|--|
| 1. | WHT | |
| 2. | BRN | |
| 3. | GRN | |
| 4. | YEL | |
| 5. | GRY | |
| 6. | PINK | |
| 7. | BLU | |
| 8. | RED | |

AC

2 CONTACTS

| | | |
|----|-----|--|
| 1. | BRN | |
| 2. | BLU | |

3 CONTACTS

| | | |
|----|---------|--|
| 1. | GRN | |
| 2. | RED/BLK | |
| 3. | RED/WHT | |

4 CONTACTS

| | | |
|----|---------|--|
| 1. | RED/BLK | |
| 2. | RED/WHT | |
| 3. | RED | |
| 4. | GRN | |

5 CONTACTS

| | | |
|----|---------|--|
| 1. | RED/WHT | |
| 2. | RED | |
| 3. | GRN | |
| 4. | RED/YEL | |
| 5. | RED/BLK | |

6 CONTACTS

| | | |
|----|---------|--|
| 1. | RED/WHT | |
| 2. | RED | |
| 3. | GRN | |
| 4. | RED/YEL | |
| 5. | RED/BLK | |
| 6. | RED/BLU | |

SENSOR LINK PRODUCT LINE

MICRO-MIZER® SPECIFICATIONS

STANDARD PANEL MOUNTS:

- 22 AWG, 80°C, 300V, PVC Hook-up Wire
- Nylon Insert
- Lead Length 12 In.
- Epoxy Filled

STANDARD AC & DC METAL:

- 22 AWG, PVC Yellow Jacketed Cable
- Nylon Insert (Black for AC, Yellow for DC)
- PVC, Yellow Overmold
- Length 3, 6 and 12 Ft. for AC 1, 2 and 4 Meters for DC

Options

- 22 AWG, Polyurethane Yellow Jacketed Cable
For polyurethane cable add suffix "U"
- 22 AWG, PVC & Polyurethane Yellow Jacketed Shielded Cable
For Shielded Cable add suffix "S"
- Lengths other than standard

STANDARD SINGLE KEY PLASTIC:

- 22 AWG, PVC Yellow Jacketed Cable
 - Nylon, Black Insert
 - PVC, Black Overmold
 - Length 1, 2 and 4 Meters
- Options
- 22 AWG, Polyurethane Yellow Jacketed Cable
For polyurethane cable add suffix "U"
 - 22 AWG, PVC & Polyurethane Yellow Jacketed Shielded Cable
For Shielded Cable add suffix "S"
 - Lengths other than standard

Y-SPLITTER ASSEMBLIES:

- 22 AWG, PVC Yellow Jacketed Cable
 - Nylon Insert
 - PVC Overmold
- Options
- 22 AWG, Polyurethane Yellow Jacketed Cable

DC LED CORDSETS:

- 1 Green & 1 Yellow Extended Life LEDs (Typical life @ ambient temperature is 100,000 hours.)
 - PNP or NPN
 - 22 AWG, PVC Yellow Jacketed Cable
 - Nylon Insert
 - PVC, Clear Overmold
- Options
- 22 AWG, Polyurethane Yellow Jacketed Cable
 - Polyurethane, Clear Overmold

**SENSOR LINK
PRODUCT LINE**

MICRO-MIZER® AC/DC METAL AND PLASTIC

ELECTRICAL RATING

VOLTAGE: Metal/Plastic (Non-LED Assemblies) - 300V
Metal (LED Assemblies) - 10-30V DC

CABLE ASSEMBLIES

COUPLING NUT: Metal-Anodized Aluminum
Plastic-Nylon
Optional-Nickel-plated Brass or Stainless Steel
(Consult Factory)

CONTACTS: Metal/Plastic-Copper Alloy, Gold-plated

INSERT: Metal/Plastic-Nylon

MOLDED HEADS: Metal/Plastic-PVC

O-RINGS: Metal/Plastic-Viton

CABLE: Metal/Plastic-22 AWG: PVC Insulated, Fine Stranded Copper Conductors,
Yellow Oil Resistant PVC Jacketed 300V, ST, 105°C.
UL Recognized, CSA Certified

PANEL MOUNT ASSEMBLIES

SHELLS: Metal-Anodized Aluminum
Plastic-Nylon

Optional-Nickel-plated Brass
(Consult Factory)

CONTACTS: Metal/Plastic-Copper Alloy, Gold-plated

INSERTS: Metal-Nylon

WIRE: Metal/Plastic-22 AWG PVC Insulated, 300V
UL Recognized, CSA Certified

ENVIRONMENTAL

PROTECTION: Metal/Plastic-NEMA 6P, IP67 & IP68

OPERATING

AMBIENT: Metal/Plastic--20° to 80°C

CERTIFICATIONS

UL: Metal/Plastic-UL Recognized,
File No. E150822

cUL: Metal/Plastic-Canadian UL Recognized,
File No. E150822

CSA: Metal/Plastic-CSA
Certified File No. 181200

SENSOR-LINK NANO-MIZER®

MOLDED CONNECTOR ASSEMBLIES

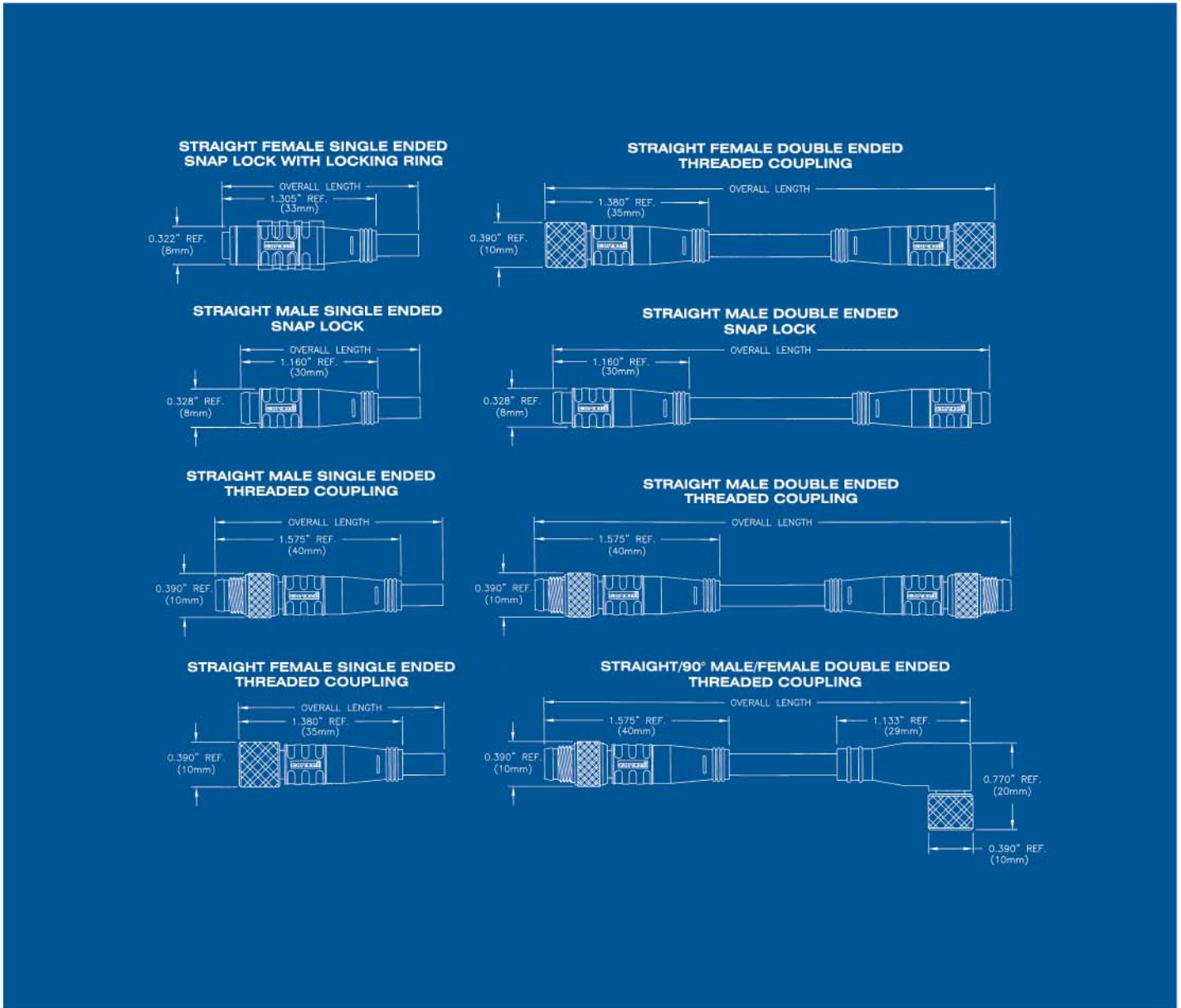

| Face View Male | Coupling Options | | Snap Lock Threaded Straight Male Single Ended | Snap Lock w/ Ring | Snap Lock w/ Ring | Receptacle Male .3 Meter Lead | Receptacle Female .3 Meter Lead | Snap Lock Threaded Straight Male/Male Double Ended |
|----------------|------------------|-----------------------|---|--------------------|--------------------|-------------------------------|---------------------------------|--|
| | Rating | Overall Length Meters | | Snap Lock Threaded | Snap Lock Threaded | | | |
| | 4 A 300V | 2 | 603P*2 | 603S*2* | 653S*2* | 613P.3 | 613S.3 | 673P3P*2 |
| | | 5 | 603P*5 | 603S*5* | 653S*5* | | | 673P3P*5 |
| | | 6 | 603P*6 | 603S*6* | 653S*6* | | | 673P3P*6 |
| | | Custom | 603P*XX | 603S*XX* | 653S*XX* | | | 613PXX |
| | 4 A 300V | 2 | 604P*2 | 604S*2* | 654S*2* | 614P.3 | 614S.3 | 674P4P*2 |
| | | 5 | 604P*5 | 604S*5* | 654S*5* | | | 674P4P*5 |
| | | 6 | 604P*6 | 604S*6* | 654S*6* | | | 674P4P*6 |
| | | Custom | 604P*XX | 604S*XX* | 654S*XX* | | | 614PXX |



| Snap Lock w/ Ring | Snap Lock w/ Ring | Snap Lock w/ Ring | Snap Lock w/ Ring | Snap Lock w/ Ring |
|-------------------------------------|-----------------------------------|--------------------------------|--|--|
| Snap Lock | Snap Lock | Snap Lock | Snap Lock | Snap Lock |
| Threaded | Threaded | Threaded | Threaded | Threaded |
| Straight Female/Female Double Ended | Straight Female/Male Double Ended | 90° Female/Female Double Ended | Straight to 90° Female/Female Double Ended | Straight to 90° Male/Female Double Ended |
| 673S3S*2* | 673S3P*2* | 663S3S*2* | 683S3S*2* | 683P3S*2* |
| 673S3S*5* | 673S3P*5* | 663S3S*5* | 683S3S*5* | 683P3S*5* |
| 673S3S*6* | 673S3P*6* | 663S3S*6* | 683S3S*6* | 683P3S*6* |
| 673S3S*XX* | 673S3P*XX* | 663S3S*XX* | 683S3S*XX* | 683P3S*XX* |
| 674S4S*2* | 674S4P*2* | 664S4S*2* | 684S4S*2* | 684P4S*2* |
| 674S4S*5* | 674S4P*5* | 664S4S*5* | 684S4S*5* | 684P4S*5* |
| 674S4S*6* | 674S4P*6* | 664S4S*6* | 684S4S*6* | 684P4S*6* |
| 674S4S*XX* | 674S4P*XX* | 664S4S*XX* | 684S4S*XX* | 684P4S*XX* |

Coupling Code Example:
 604SS2L = Snap Lock with Locking Ring
 604SS2 = Snap Lock without Locking Ring
 604SI2 = Threaded

Note: XX - Indicates "overall length / lead length" in meters

Ordering Code Example:
 683P3S * XX *

Optional L = Locking Ring
 Length in Meters
 S = Snap Lock
 T = Threaded



* Please visit the product pages on our website for the most up-to-date product information

SENSOR-LINK NANO-MIZER[®] EMI/RFI SHIELDED MOLDED CONNECTOR ASSEMBLIES

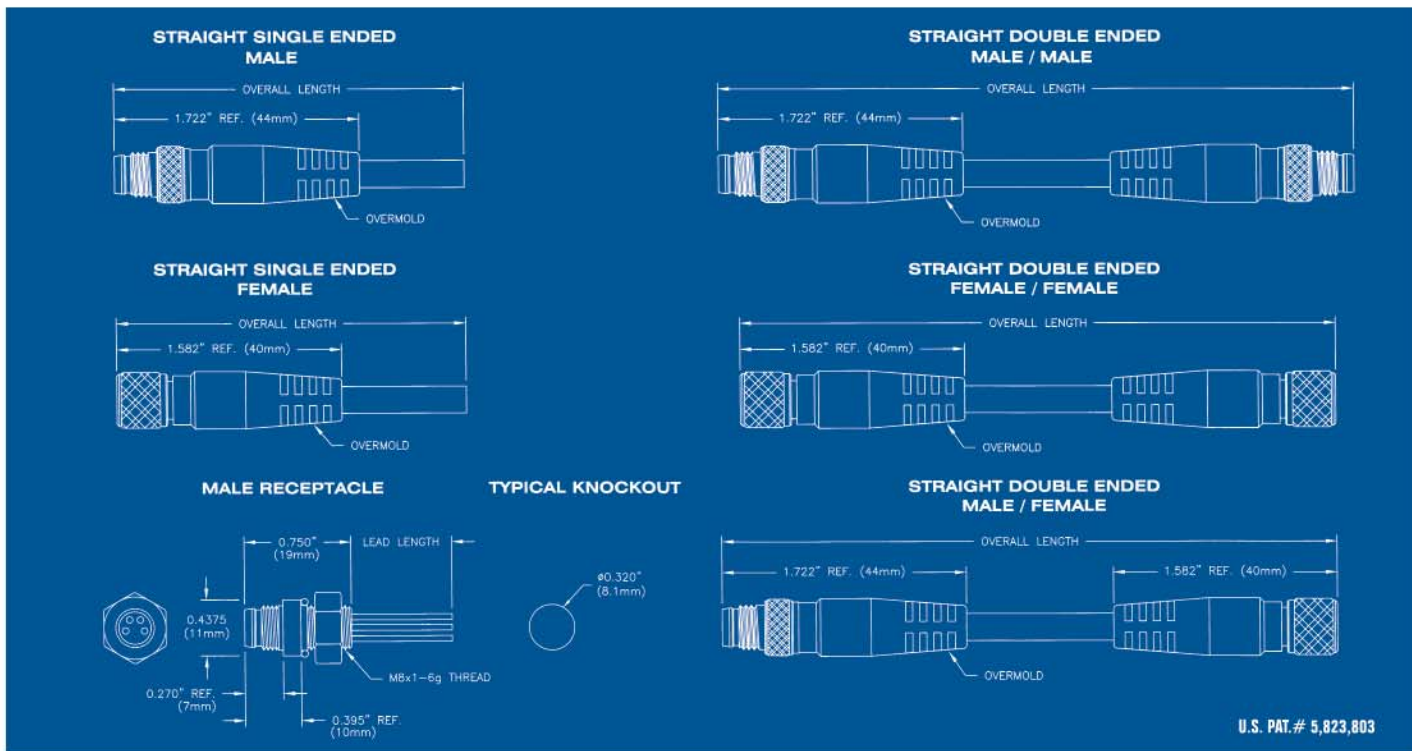

U.S. PAT.# 5,823,803

| Face View Male | Rating | Overall Length Meters | Straight Inline Male Single Ended | Straight Female Single Ended | Straight Inline Male Double Ended | Straight Female/Female Double Ended | Straight Female/Male Double Ended | Receptacle Male .3 Meter Leads |
|----------------|------------|-----------------------|-----------------------------------|------------------------------|-----------------------------------|-------------------------------------|-----------------------------------|--------------------------------|
| | 4A 125V | 2 | SH603PT2 | SH603ST2 | SH673P3PT2 | SH673S3ST2 | SH673S3PT2 | |
| | | 5 | SH603PT5 | SH603ST5 | SH673P3PT5 | SH673S3ST5 | SH673S3PT5 | SH613P.3 |
| | | 6 | SH603PT6 | SH603ST6 | SH673P3PT6 | SH673S3ST6 | SH673S3PT6 | |
| | | Custom | SH603PTXX | SH603STXX | SH673P3PTXX | SH673S3STXX | SH673S3PTXX | SH613PXX |
| | 4A 125V | 2 | SH604PT2 | SH604ST2 | SH674P4PT2 | SH674S4ST2 | SH674S4PT2 | |
| | | 5 | SH604PT5 | SH604ST5 | SH674P4PT5 | SH674S4ST5 | SH674S4PT5 | SH614P.3 |
| | | 6 | SH604PT6 | SH604ST6 | SH674P4PT6 | SH674S4ST6 | SH674S4PT6 | |
| | | Custom | SH604PTXX | SH603STXX | SH674P4PTXX | SH674S4STXX | SH674S4PTXX | SH614PXX |

For mechanical, electrical and wiring sequence see page 33.

SENSOR-LINK NANO-MIZER®



MOLDED CONNECTOR ASSEMBLIES

SENSOR LINK PRODUCT LINE NANO-MIZER® SPECIFICATIONS

ELECTRICAL RATING

VOLTAGE: 300V, 4 Amps (Non-Shielded);
125V, 4 Amps (Shielded)

CABLE ASSEMBLIES

COUPLING NUT: Nickel Plated Brass
CONTACTS: Copper Alloy, Gold-Plated
INSERT: G.F. Nylon
MOLDED HEADS: PVC
O-RINGS: Viton
CABLE: .25mm² (or approximately 24 AWG) PVC Insulated, Fine Stranded Copper Conductors, Yellow Oil Resistant PVC Jacketed 300V, ST, 105°C. UL Recognized, CSA Certified

PANEL MOUNT ASSEMBLIES

SHELLS: Nickel plated brass
CONTACTS: Copper Alloy Gold-Plated
INSERTS: G.F. Nylon
WIRE: 24 AWG PVC Insulated, 300V UL Recognized, CSA Certified

ENVIRONMENTAL

PROTECTION: NEMA 6P, IP67 & IP68

OPERATING AMBIENT: -20° to 105°C

CERTIFICATIONS

UL: UL Recognized, File No. E-150822

CSA: CSA Certified File No.181200

STANDARD NANO-MIZER WIRING SEQUENCE

Panel Mounts and Cable Assemblies Conductor Color Code per Contact Position:

3 CONTACTS

- 1. BRN
- 3. BLU
- 4. BLK



4 CONTACTS

- 1. BRN
- 2. WHT
- 3. BLU
- 4. BLK



* Please visit the product pages on our website for the most up-to-date product information

SENSOR-LINK DIE BLOCK CONNECTORS

MOLDED CONNECTOR ASSEMBLIES

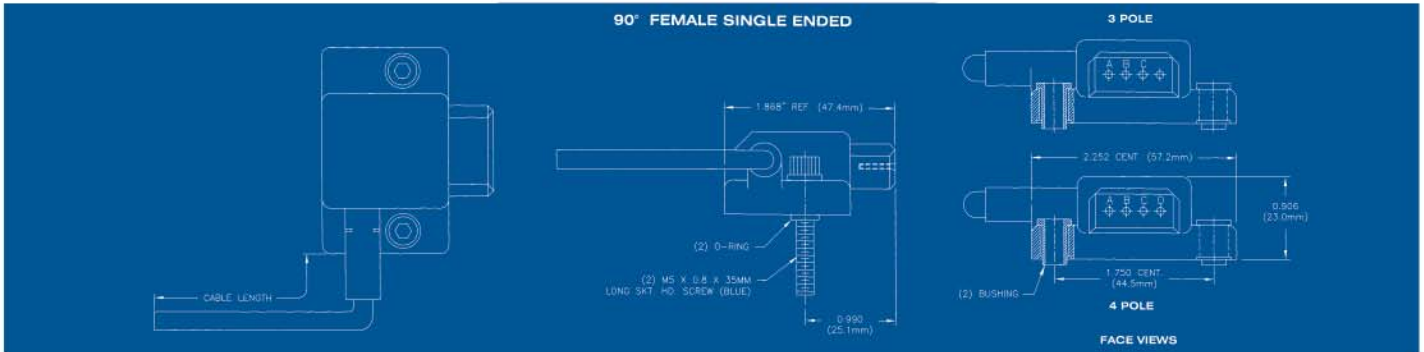

| Rating | Cable Length Feet | 3-Pole Yellow 90° Female Die Block | 3-Pole Blue 90° Female Die Block | 4-Pole Yellow 90° Female Die Block | 4-Pole Blue 90° Female Die Block |
|--------|-------------------|------------------------------------|----------------------------------|------------------------------------|----------------------------------|
| 7.5A | 6 | DBR3S3-6 | DBR3S2-6 | DBR4S3-6 | DBR4S2-6 |
| | 10 | DBR3S3-10 | DBR3S2-10 | DBR4S3-10 | DBR4S2-10 |
| 300VAC | 12 | DBR3S3-12 | DBR3S2-12 | DBR4S3-12 | DBR4S2-12 |
| | 20 | DBR3S3-20 | DBR3S2-20 | DBR4S3-20 | DBR4S2-20 |
| 24VDC | Custom | DBR3S3-XX | DBR3S2-XX | DBR4S3-XX | DBR4S2-XX |

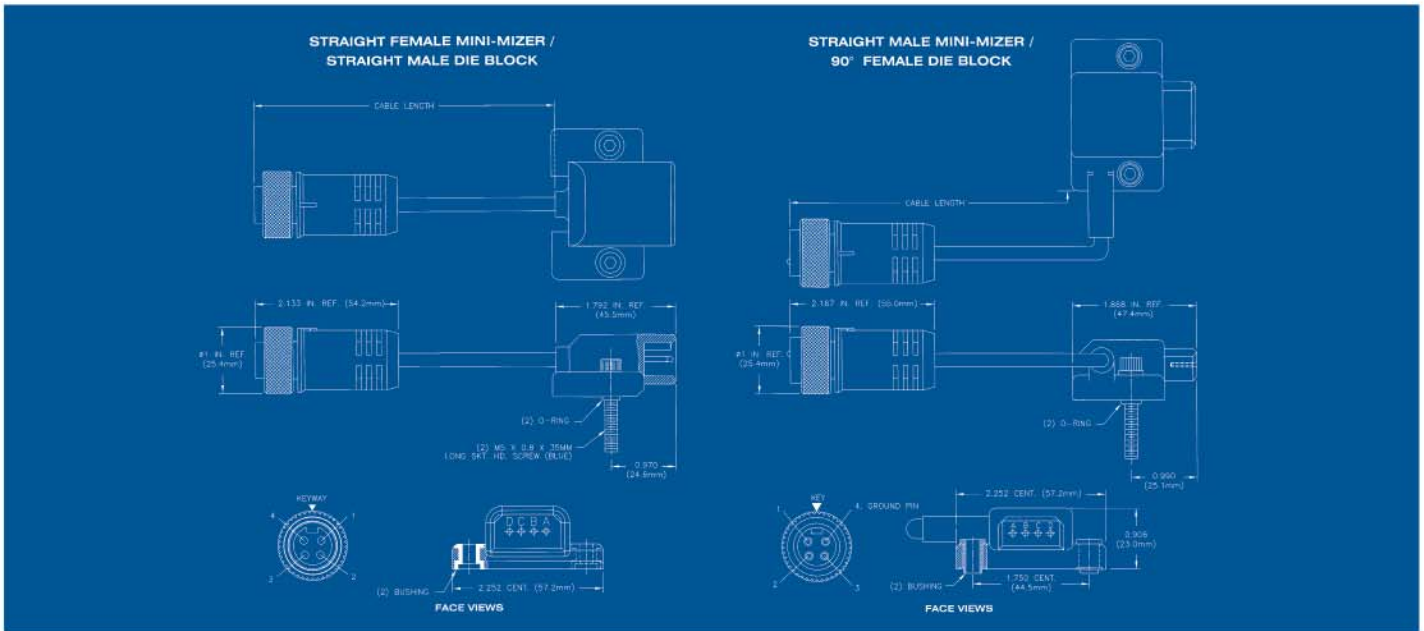

| # Of Poles | Rating | Cable Length Feet | Yellow Straight Female Mini-Mizer to Straight Male Die Block | Blue Straight Female Mini-Mizer to Straight Male Die Block | Yellow Straight Male Mini-Mizer to 90° Female Die Block | Blue Straight Male Mini-Mizer to 90° Female Die Block |
|------------|--------|-------------------|--|--|---|---|
| 4 | 7.5A | 1 | DB20S4SS4P3-1 | DB20S4SS4P2-1 | DB20S4PR4S3-1 | DB20S4PR4S2-1 |
| | | 2 | DB20S4SS4P3-2 | DB20S4SS4P2-2 | DB20S4PR4S3-2 | DB20S4PR4S2-2 |
| | 300VAC | 3 | DB20S4SS4P3-3 | DB20S4SS4P2-3 | DB20S4PR4S3-3 | DB20S4PR4S2-3 |
| | | 4 | DB20S4SS4P3-4 | DB20S4SS4P2-4 | DB20S4PR4S3-4 | DB20S4PR4S2-4 |
| | 24VDC | 6 | DB20S4SS4P3-6 | DB20S4SS4P2-6 | DB20S4PR4S3-6 | DB20S4PR4S2-6 |
| | | 12 | DB20S4SS4P3-12 | DB20S4SS4P2-12 | DB20S4PR4S3-12 | DB20S4PR4S2-12 |
| | Custom | DB20S4SS4P3-XX | DB20S4SS4P2-XX | DB20S4PR4S3-XX | DB20S4PR4S2-XX | |

XX - Indicates "Overall Length" in feet.
For mechanical, electrical and wiring sequence see page 37.



| # Of Poles | Rating | Cable Length Feet | Yellow Straight Female AC Micro-Mizer to Straight Male Die Block | Red Straight Female AC Micro-Mizer to Straight Male Die Block | Yellow Straight Female AC Micro-Mizer to 90° Female Die Block | Red Straight Female AC Micro-Mizer to 90° Female Die Block |
|------------|-----------------|-------------------|--|---|---|--|
| 3 | 300VAC 24VDC | 1 | DB40S3SS3P3-1 | DB40S3SS3P1-1 | DB40S3SR3S3-1 | DB40S3SR3S1-1 |
| | | 2 | DB40S3SS3P3-2 | DB40S3SS3P1-2 | DB40S3SR3S3-2 | DB40S3SR3S1-2 |
| | | 3 | DB40S3SS3P3-3 | DB40S3SS3P1-3 | DB40S3SR3S3-3 | DB40S3SR3S1-3 |
| | | 4 | DB40S3SS3P3-4 | DB40S3SS3P1-4 | DB40S3SR3S3-4 | DB40S3SR3S1-4 |
| | | 6 | DB40S3SS3P3-6 | DB40S3SS3P1-6 | DB40S3SR3S3-6 | DB40S3SR3S1-6 |
| | | 12 | DB40S3SS3P3-12 | DB40S3SS3P1-12 | DB40S3SR3S3-12 | DB40S3SR3S1-12 |
| | | Custom | DB40S3SS3P3-XX | DB40S3SS3P1-XX | DB40S3SR3S3-XX | DB40S3SR3S1-XX |
| 4 | 300VAC 24VDC | 1 | DB40S4SS4P3-1 | DB40S4SS4P1-1 | DB40S4SR4S3-1 | DB40S4SR4S1-1 |
| | | 2 | DB40S4SS4P3-2 | DB40S4SS4P1-2 | DB40S4SR4S3-2 | DB40S4SR4S1-2 |
| | | 3 | DB40S4SS4P3-3 | DB40S4SS4P1-3 | DB40S4SR4S3-3 | DB40S4SR4S1-3 |
| | | 4 | DB40S4SS4P3-4 | DB40S4SS4P1-4 | DB40S4SR4S3-4 | DB40S4SR4S1-4 |
| | | 6 | DB40S4SS4P3-6 | DB40S4SS4P1-6 | DB40S4SR4S3-6 | DB40S4SR4S1-6 |
| | | 12 | DB40S4SS4P3-12 | DB40S4SS4P1-12 | DB40S4SR4S3-12 | DB40S4SR4S1-12 |
| | | Custom | DB40S4SS4P3-XX | DB40S4SS4P1-XX | DB40S4SR4S3-XX | DB40S4SR4S1-XX |

XX - Indicates "Overall Length" in feet.
For mechanical, electrical and wiring sequence see page 37.

SENSOR-LINK DIE BLOCK CONNECTORS

MOLDED CONNECTOR ASSEMBLIES



| # Of Poles | Rating | Cable Length Feet | Yellow Straight Female DC Micro-Mizer to Straight Male Die Block | Blue Straight Female DC Micro-Mizer to Straight Male Die Block | Yellow Straight Female DC Micro-Mizer to 90° Female Die Block | Blue Straight Female DC Micro-Mizer to 90° Female Die Block |
|------------|-----------------|-------------------|--|--|---|---|
| 3 | 300VAC 24VDC | 1 | DB30S3SS3P3-1 | DB30S3SS3P2-1 | DB30S3SR3S3-1 | DB30S3SR3S2-1 |
| | | 2 | DB30S3SS3P3-2 | DB30S3SS3P2-2 | DB30S3SR3S3-2 | DB30S3SR3S2-2 |
| | | 3 | DB30S3SS3P3-3 | DB30S3SS3P2-3 | DB30S3SR3S3-3 | DB30S3SR3S2-3 |
| | | 4 | DB30S3SS3P3-4 | DB30S3SS3P2-4 | DB30S3SR3S3-4 | DB30S3SR3S2-4 |
| | | 6 | DB30S3SS3P3-6 | DB30S3SS3P2-6 | DB30S3SR3S3-6 | DB30S3SR3S2-6 |
| | | 12 | DB30S3SS3P3-12 | DB30S3SS3P2-12 | DB30S3SR3S3-12 | DB30S3SR3S2-12 |
| | | Custom | DB30S3SS3P3-XX | DB30S3SS3P2-XX | DB30S3SR3S3-XX | DB30S3SR3S2-XX |
| 4 | 300VAC 24VDC | 1 | DB30S4SS4P3-1 | DB30S4SS4P2-1 | DB30S4SR4S3-1 | DB30S4SR4S2-1 |
| | | 2 | DB30S4SS4P3-2 | DB30S4SS4P2-2 | DB30S4SR4S3-2 | DB30S4SR4S2-2 |
| | | 3 | DB30S4SS4P3-3 | DB30S4SS4P2-3 | DB30S4SR4S3-3 | DB30S4SR4S2-3 |
| | | 4 | DB30S4SS4P3-4 | DB30S4SS4P2-4 | DB30S4SR4S3-4 | DB30S4SR4S2-4 |
| | | 6 | DB30S4SS4P3-6 | DB30S4SS4P2-6 | DB30S4SR4S3-6 | DB30S4SR4S2-6 |
| | | 12 | DB30S4SS4P3-12 | DB30S4SS4P2-12 | DB30S4SR4S3-12 | DB30S4SR4S2-12 |
| | | Custom | DB30S4SS4P3-XX | DB30S4SS4P2-XX | DB30S4SR4S3-XX | DB30S4SR4S2-XX |

XX - Indicates "Overall Length" in feet.
For mechanical, electrical and wiring sequence see page 37.

SENSOR-LINK DIE BLOCK CONNECTORS



MOLDED CONNECTOR ASSEMBLIES

SENSOR LINK PRODUCT LINE DIE BLOCK CONNECTORS SPECIFICATIONS

ELECTRICAL RATING

VOLTAGE: 300 VAC
24 VDC

MATERIALS

- COUPLING NUT:** Anodized Aluminum
- CONTACTS:** Copper Alloy, Gold-Plated
- MOLDED HEADS:** Polyurethane
- O-RINGS:** Viton
- CABLE:** 18 AWG, PVC Yellow Jacket Cable
- BUSHINGS:** Stainless Steel

STANDARD DIE BLOCK CONNECTOR WIRING SEQUENCE

Assembly Conductor Color Code per Contact Position:
(Below diagrams reflect Face View Female view)

Single Ended Die Block

3 Pole:

- A BRN
- B BLU
- C BLK



4 Pole:

- A RED/BLK
- B RED/WHT
- C RED
- D GRN



4-Pole Mini-Mizer to Die Block

- | | |
|-----------|-----------|
| 1 RED/BLK | A RED/BLK |
| 2 RED/WHT | B RED/WHT |
| 3 RED | C RED |
| 4 GRN | D GRN |

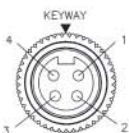

STANDARD DIE BLOCK CONNECTOR WIRING SEQUENCE (continued)

AC Micro-Mizer to Die Block

3 Pole:

- | | |
|-----------|-----------|
| 1 GRN | A GRN |
| 2 RED/WHT | B RED/WHT |
| 3 RED/BLK | C RED/BLK |



("D" Position of a 3-pole female die block is molded open to accept a 4-pole mate.)

4 Pole:

- | | |
|-----------|-----------|
| 1 RED/BLK | A RED/BLK |
| 2 RED/WHT | B RED/WHT |
| 3 RED | C RED |
| 4 GRN | D GRN |



DC Micro-Mizer to Die Block

3 Pole:

- | | |
|-------|-------|
| 1 BRN | A BRN |
| 2 BLU | B BLU |
| 3 BLK | C BLK |



("D" Position of a 3-pole female die block is molded open to accept a 4-pole mate.)

4 Pole:

- | | |
|-------|-------|
| 1 BRN | A BLK |
| 2 WHT | B BLU |
| 3 BLU | C WHT |
| 4 BLK | D BRN |



SENSOR-LINK MULTI-PORT "A" Size MINI-MIZER® JUNCTION BOXES



Junction Box P/N Sequence



SENSOR-LINK MULTI-PORT "A" Size MINI-MIZER[®]



JUNCTION BOXES

SENSOR LINK PRODUCT LINE

MULTI-PORT "A" Size MINI-MIZER[®] JUNCTION BOXES

FEATURES

- 2, 3, 4, 5, 6 pole "A" Size Mini-Mizer I/O ports.
- Available in 4, 6, & 8 ports.
- Internally or externally threaded ports.
- Home Run Connector or Home Run Cable.
- Home Run Connector available in "A" & "C" Size Mini-Mizer.
- 36, 72, or 144 inch standard cable lengths.
- Customer specified lengths available upon request.
- Wiring can be parallel or series.
- Assemblies are epoxy sealed.
- Available with or without LEDs
- Uses standard cables, "Y" connectors and splitters available from Conxall.
- Port environmental covers are available.

SPECIFICATIONS

- Junction Box is rated at 7 amps at 600 volts.
- Temperature rating: -20° C - +80° C.
- UL Recognized, File number E150822.
- Meets IP68 requirements.

MATERIALS

- Enclosure - PBT plastic
- Receptacle Shells - Anodized aluminum
- Consult factory for stainless steel or nickel plated brass receptacle shells.
- Contacts - Gold over nickel plated copper alloy
- Cable - 16 AWG, PVC Yellow Jacketed
- Connector Inserts - Santoprene

Consult factory for wiring diagrams.

Consult factory for customization.

* Please visit the product pages on our website for the most up-to-date product information

SENSOR-LINK MULTI-PORT DC MICRO-MIZER®

JUNCTION BOXES



PNP CIRCUIT (current sinking) / NORMALLY OPEN OR NORMALLY CLOSED [1 green LED per box - power indicator / 1 yellow LED per port - I/O indicator]

| # OF PORTS | N/O - N/C | CABLE LENGTH | CONNECTOR | I/O PIN # | PART NUMBER |
|------------|-----------|--------------|-------------------|-----------|--------------|
| 8 | OPEN | 1 | NONE | 4 | JD085SNM15 |
| 8 | OPEN | 5 | NONE | 4 | JD085SNM55 |
| 8 | OPEN | 10 | NONE | 4 | JD085SNM105 |
| 8 | OPEN | 1 | 12 POLE MALE MINI | 4 | JD085SNM1B5 |
| 8 | OPEN | 5 | 12 POLE MALE MINI | 4 | JD085SNM5B5 |
| 8 | OPEN | 10 | 12 POLE MALE MINI | 4 | JD085SNM10B5 |
| 8 | CLOSED | 1 | NONE | 2 | JD085SNM16 |
| 8 | CLOSED | 5 | NONE | 2 | JD085SNM56 |
| 8 | CLOSED | 10 | NONE | 2 | JD085SNM106 |
| 8 | CLOSED | 1 | 12 POLE MALE MINI | 2 | JD085SNM1B6 |
| 8 | CLOSED | 5 | 12 POLE MALE MINI | 2 | JD085SNM5B6 |
| 8 | CLOSED | 10 | 12 POLE MALE MINI | 2 | JD085SNM10B6 |

NPN CIRCUIT (current sourcing) / NORMALLY OPEN OR NORMALLY CLOSED [1 green LED per box - power indicator / 1 yellow LED per port - I/O indicator]

| # OF PORTS | N/O - N/C | CABLE LENGTH | CONNECTOR | I/O PIN # | PART NUMBER |
|------------|-----------|--------------|-------------------|-----------|--------------|
| 8 | OPEN | 1 | NONE | 4 | JD085SNM13 |
| 8 | OPEN | 5 | NONE | 4 | JD085SNM53 |
| 8 | OPEN | 10 | NONE | 4 | JD085SNM103 |
| 8 | OPEN | 1 | 12 POLE MALE MINI | 4 | JD085SNM1B3 |
| 8 | OPEN | 5 | 12 POLE MALE MINI | 4 | JD085SNM5B3 |
| 8 | OPEN | 10 | 12 POLE MALE MINI | 4 | JD085SNM10B3 |
| 8 | CLOSED | 1 | NONE | 2 | JD085SNM14 |
| 8 | CLOSED | 5 | NONE | 2 | JD085SNM54 |
| 8 | CLOSED | 10 | NONE | 2 | JD085SNM104 |
| 8 | CLOSED | 1 | 12 POLE MALE MINI | 2 | JD085SNM1B4 |
| 8 | CLOSED | 5 | 12 POLE MALE MINI | 2 | JD085SNM5B4 |
| 8 | CLOSED | 10 | 12 POLE MALE MINI | 2 | JD085SNM10B4 |



TWIN WIRED PNP CIRCUIT (current sinking)
[1 green LED per box - power indicator / 2 yellow LED per port - I/O indicator]

| # OF PORTS | CABLE LENGTH | CONNECTOR | I/O PIN # | PART NUMBER |
|------------|--------------|-------------------|-----------|--------------|
| 8 | 1 | NONE | 2 & 4 | JD085SNM18 |
| 8 | 5 | NONE | 2 & 4 | JD085SNM58 |
| 8 | 10 | NONE | 2 & 4 | JD085SNM108 |
| 8 | 1 | 19 POLE MALE MINI | 2 & 4 | JD085SNM1B8 |
| 8 | 5 | 19 POLE MALE MINI | 2 & 4 | JD085SNM5B8 |
| 8 | 10 | 19 POLE MALE MINI | 2 & 4 | JD085SNM10B8 |

TWIN WIRED NPN CIRCUIT (current sourcing)
[1 green LED per box - power indicator / 2 yellow LED per port - I/O indicator]

| # OF PORTS | CABLE LENGTH | CONNECTOR | I/O PIN # | PART NUMBER |
|------------|--------------|-------------------|-----------|--------------|
| 8 | 1 | NONE | 2 & 4 | JD085SNM17 |
| 8 | 5 | NONE | 2 & 4 | JD085SNM57 |
| 8 | 10 | NONE | 2 & 4 | JD085SNM107 |
| 8 | 1 | 19 POLE MALE MINI | 2 & 4 | JD085SNM1B7 |
| 8 | 5 | 19 POLE MALE MINI | 2 & 4 | JD085SNM5B7 |
| 8 | 10 | 19 POLE MALE MINI | 2 & 4 | JD085SNM10B7 |

POWER LED ONLY - NORMALLY OPEN OR NORMALLY CLOSED
[1 green LED per box - power indicator / no port I/O LED indicator]

| # OF PORTS | N/O - N/C | CABLE LENGTH | CONNECTOR | I/O PIN # | PART NUMBER |
|------------|-----------|--------------|-------------------|-----------|---------------|
| 8 | OPEN | 1 | NONE | 4 | JD085SNM19 |
| 8 | OPEN | 5 | NONE | 4 | JD085SNM59 |
| 8 | OPEN | 10 | NONE | 4 | JD085SNM109 |
| 8 | OPEN | 1 | 12 POLE MALE MINI | 4 | JD085SNM1B9 |
| 8 | OPEN | 5 | 12 POLE MALE MINI | 4 | JD085SNM5B9 |
| 8 | OPEN | 10 | 12 POLE MALE MINI | 4 | JD085SNM10B9 |
| 8 | CLOSED | 1 | NONE | 2 | JD085SNM110 |
| 8 | CLOSED | 5 | NONE | 2 | JD085SNM510 |
| 8 | CLOSED | 10 | NONE | 2 | JD085SNM1010 |
| 8 | CLOSED | 1 | 12 POLE MALE MINI | 2 | JD085SNM1B10 |
| 8 | CLOSED | 5 | 12 POLE MALE MINI | 2 | JD085SNM5B10 |
| 8 | CLOSED | 10 | 12 POLE MALE MINI | 2 | JD085SNM10B10 |

NO LED - NORMALLY OPEN OR NORMALLY CLOSED
[no box LED power indicator / no port I/O LED indicator]

| # OF PORTS | N/O - N/C | CABLE LENGTH | CONNECTOR | I/O PIN # | PART NUMBER |
|------------|-----------|--------------|-------------------|-----------|--------------|
| 8 | OPEN | 1 | NONE | 4 | JD085SNM11 |
| 8 | OPEN | 5 | NONE | 4 | JD085SNM51 |
| 8 | OPEN | 10 | NONE | 4 | JD085SNM101 |
| 8 | OPEN | 1 | 12 POLE MALE MINI | 4 | JD085SNM1B1 |
| 8 | OPEN | 5 | 12 POLE MALE MINI | 4 | JD085SNM5B1 |
| 8 | OPEN | 10 | 12 POLE MALE MINI | 4 | JD085SNM10B1 |
| 8 | CLOSED | 1 | NONE | 2 | JD085SNM12 |
| 8 | CLOSED | 5 | NONE | 2 | JD085SNM52 |
| 8 | CLOSED | 10 | NONE | 2 | JD085SNM102 |
| 8 | CLOSED | 1 | 12 POLE MALE MINI | 2 | JD085SNM1B2 |
| 8 | CLOSED | 5 | 12 POLE MALE MINI | 2 | JD085SNM5B2 |
| 8 | CLOSED | 10 | 12 POLE MALE MINI | 2 | JD085SNM10B2 |

SENSOR-LINK MULTI-PORT DC MICRO-MIZER®

JUNCTION BOXES

SENSOR LINK
PRODUCT LINE

MULTI-PORT DC MICRO-MIZER® JUNCTION BOXES

FEATURES

- 5 pole 12 mm DC Micro I/O ports.
- Blunt cut cable, 12 pole male connector or 19 pole male connector options.
- 1, 5, or 10 meter standard cable lengths.
- Customer specified lengths available upon request.
- PNP (current sinking) or NPN (current sourcing) options.
- Normally Open (pin #4) or Normally Closed (pin #2) wiring options.
- Port designation tabs included.
- Environmental port covers included.
- Assemblies are epoxy sealed.
- Available with 2 I/O LEDs per port, 1 I/O LED per port, power LED only, or no LEDs.
- Custom assemblies built to customer specifications upon request.
- Uses standard cables, Y connectors, and splitters available from Conxall.

SPECIFICATIONS

- Individual ports are rated at 4 amps at 30 volts.
- Junction box is rated at 12 amps at 30 volts.
- Temperature rating: -20° C - +80° C.
- UL Recognized, File number E150822.
- Meets IP68 requirements.

MATERIALS

- Enclosure - Modified PPO plastic
- Receptacle Shells - Nickel plated brass
- Consult factory for stainless steel receptacle shells.
- Contacts - Gold over nickel plated copper alloy
- Cable - 8 - #22 & 3 - #18 with PVC insulation and PUR jacket.
- Connector inserts - Nylon
- Port environmental covers - Nylon
- Port designation tabs - Styrene

Consult factory for wiring diagrams.

Consult factory for 4 or 6 port options.

Consult factory for 4, 6, or 8 Port AC version Junction Boxes.

NEW PRODUCTS



MICRO-MIZER® / NANO-MIZER® "T" & "Y" SPLITTERS

- Polyurethane Overmold
- Nickel plated brass coupling rings
- 4,5, or 8 positions available
- Available in series or parallel wiring
- With or without mounting tabs
- Various "T" configurations available
 - Micro-Mizer® male -to- Micro-Mizer® female with Micro-Mizer® female drop
 - Micro-Mizer® male -to- Micro-Mizer® female with Nano-Mizer® female drop
- Various "Y" configurations available
 - (1) Nano-Mizer® male -to- (2) Nano-Mizer® females
 - (1) Micro-Mizer® male -to- (2) Nano-Mizer® females
 - (1) Micro-Mizer® male -to- (2) Micro-Mizer® females

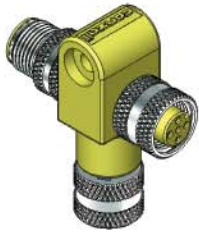



Компания «ЭлектроПласт» предлагает заключение долгосрочных отношений при поставках импортных электронных компонентов на взаимовыгодных условиях!

Наши преимущества:

- Оперативные поставки широкого спектра электронных компонентов отечественного и импортного производства напрямую от производителей и с крупнейших мировых складов;
- Поставка более 17-ти миллионов наименований электронных компонентов;
- Поставка сложных, дефицитных, либо снятых с производства позиций;
- Оперативные сроки поставки под заказ (от 5 рабочих дней);
- Экспресс доставка в любую точку России;
- Техническая поддержка проекта, помощь в подборе аналогов, поставка прототипов;
- Система менеджмента качества сертифицирована по Международному стандарту ISO 9001;
- Лицензия ФСБ на осуществление работ с использованием сведений, составляющих государственную тайну;
- Поставка специализированных компонентов (Xilinx, Altera, Analog Devices, Intersil, Interpoint, Microsemi, Aeroflex, Peregrine, Syfer, Eurofarad, Texas Instrument, Miteq, Cobham, E2V, MA-COM, Hittite, Mini-Circuits, General Dynamics и др.);

Помимо этого, одним из направлений компании «ЭлектроПласт» является направление «Источники питания». Мы предлагаем Вам помощь Конструкторского отдела:

- Подбор оптимального решения, техническое обоснование при выборе компонента;
- Подбор аналогов;
- Консультации по применению компонента;
- Поставка образцов и прототипов;
- Техническая поддержка проекта;
- Защита от снятия компонента с производства.



Как с нами связаться

Телефон: 8 (812) 309 58 32 (многоканальный)

Факс: 8 (812) 320-02-42

Электронная почта: org@eplast1.ru

Адрес: 198099, г. Санкт-Петербург, ул. Калинина, дом 2, корпус 4, литера А.