

MJTP SERIES 6MM & 4MM SMD TACT SWITCHES

FEATURES

- Numerous single pole-single throw momentary configurations.
- Excellent tactile feed-back (Snap dome).
- Ultra-compact size.
- Long operating life for high reliability.
- Molded-in terminals minimize wicking of flux or solder.

MATERIALS

| | |
|-------------------|---|
| Case: | High temperature 4/6 nylon. |
| Actuator: | High temperature 4/6 nylon. |
| Cover/Bracket: | PET film, tin plated brass or stainless steel. |
| Terminals: | Silver plated brass. |
| Shorting Contact: | Phosphor bronze or stainless steel with silver plating. |
| L.E.D. rating: | Forward voltage- 2.1 V (3.0 V Max.). Cont. fwd. current 20mA max. @ 25°C. |

Gold plating available on contacts & terminals
- consult factory.

SPECIFICATIONS SUBJECT TO CHANGE WITHOUT NOTICE.

GENERAL SPECIFICATIONS

ELECTRICALS

| | |
|----------------------------------|--|
| Contact rating: | 50 mA @ 12 VDC |
| Insulation resistance: | 100 megohms min. (100 VDC) |
| Dielectric withstanding voltage: | 250 VAC for 1 minute |
| Contact resistance: | 100 milliohms max. @ 5 VDC, 10 mA |
| Electrical life: | 100,000 cycles min. (1,000,000 cycles available - consult factory) |
| Contact bounce: | less than 10 msec. |

MECHANICALS, THERMALS, ENVIRONMENTALS

| | |
|------------------------------|---|
| Plunger travel: | .010" + .008", - .004" (0,25 +0,2, -0,1 mm) |
| Actuation force: | 160 grams ±30 grams |
| Operating temperature range: | -20°C to +70°C |
| Storage temperature range: | -30°C to +80°C for 96 hours |
| Shock resistance: | 30G per method 213, MIL-STD-202 |
| Vibration resistance: | passes method 201, MIL-STD-202 |

SOLDERING (note - non-washable except for models indicated as 'process compatible').

| | |
|----------------------|---|
| IR reflow soldering: | 240°C max. for 20 seconds max. |
| Wave soldering: | 255°C max. for 5 seconds max. |
| Hand soldering: | 320°C max. for 3.5 seconds max. (40 watt iron max.) |

US # MJTP1106S

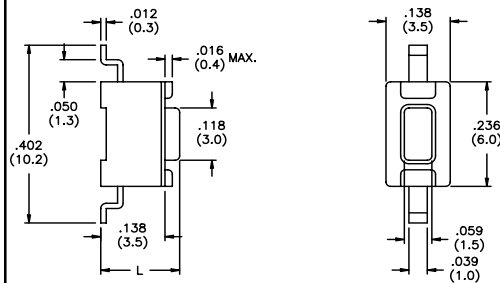

| US Model No. | Dim. L (in./mm) |
|--------------|-----------------|
| MJTP1106S | .169 (4,3) |
| MJTP1106SA | .197 (5,0) |

Bulk packaged.

US # MJTP1106SATR

Same as above, except supplied on tape and reel as shown.

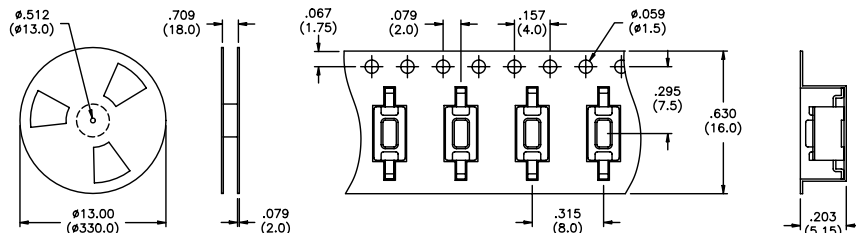

Tape & reel packaging - quantity 1800 per reel.

M

US # MJTP1122
Grounding



Bulk packaged.

US # MJTP1122A
Grounding

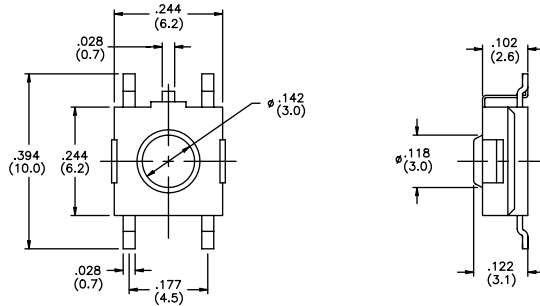

Bulk packaged.

US # MJTP1122B
EU # PHAP3374

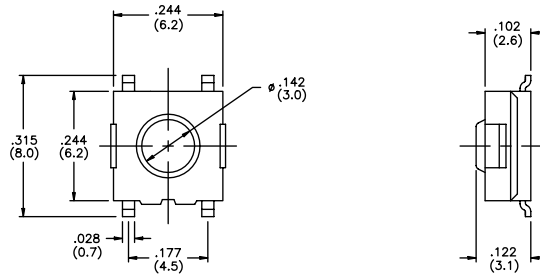

Bulk packaged.

US # MJTP1122TR,
MJTP1122BTR &
MJTP3374TR
EU # PHAP3374R

Same as above,
except supplied
on tape & reel
as shown.
Note -
MJTP1122A
not available on
tape & reel.



Tape & reel packaging - quantity 1500 per reel.

SPECIFICATIONS SUBJECT TO CHANGE WITHOUT NOTICE.

M

SPECIFICATIONS SUBJECT TO CHANGE WITHOUT NOTICE.

US # MJTP1125B

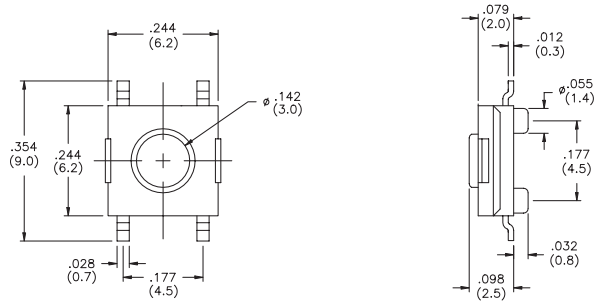

Bulk packaged.

New!

**US # MJTP1138
EU # PHAP3368**

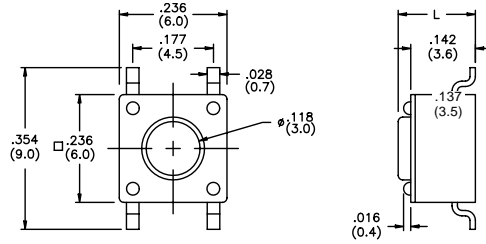

| US Model No. | Dim. L (in./mm) | EU Model No. |
|------------------|-----------------|------------------|
| MJTP1138 | .170 (4,3) | PHAP3368 |
| MJTP1138A | .197 (5,0) | PHAP3368A |
| MJTP1138B | .374 (9,5) | PHAP3368B |
| MJTP1138C | .315 (8,0) | PHAP3368C |
| MJTP1138D | .512 (13,0) | PHAP3368D |
| MJTP1138E | .287 (7,3) | PHAP3368E |
| MJTP1138F | .335 (8,5) | PHAP3368F |
| MJTP1138G | .275 (7,0) | N/A |

Bulk packaged. Tubes available for some models consult factory.

SPECIFICATIONS SUBJECT TO CHANGE WITHOUT NOTICE.

US # MJTP1138TR & MJTP1138ATR

Same as above except supplied on tape & reel as shown.



Tape & reel packaging - quantity 1200 per reel.

US # MJTP1140 EU # PHAP3390

4mm x 4mm



Bulk packaged.

US # MJTP1140A EU # PHAP3391

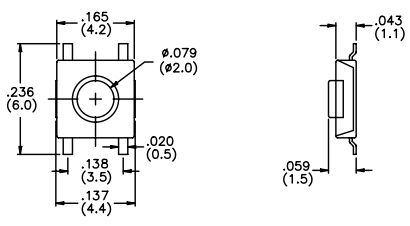

Bulk packaged.

US # MJTP1140TR & MJTP1140ATR EU # PHAP3390R & PHAP3391R

Same as above, except supplied on tape & reel as shown.



Tape & reel packaging - quantity 3400 per reel.

US # MJTP1162 EU # PHAP3371



| US Model No. | Dim. L (in./mm) | EU Model No. |
|------------------|-----------------|------------------|
| MJTP1162 | .102 (2,6) | PHAP3371 |
| MJTP1162A | .134 (3,4) | PHAP3371A |

Bulk packaged.

SPECIFICATIONS SUBJECT TO CHANGE WITHOUT NOTICE.

US # MJTP1162TR & MJTP1162ATR
EU # PHAP3371R & PHAP3371AR
 Same as above except supplied on tape & reel as shown.

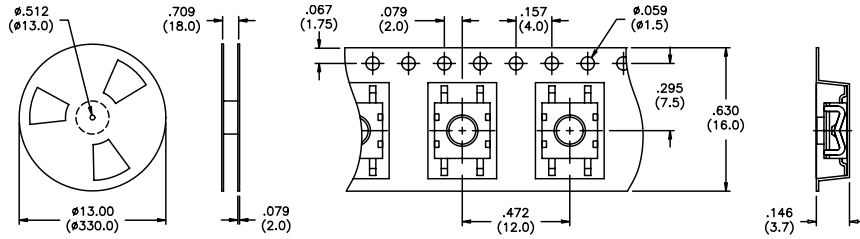

Tape & reel packaging - quantity 1600 per reel.

US # MJTPSJW66N
 Process compatible



New!



Bulk packaged.

US # MJTPSJW69N
 Process compatible



New!

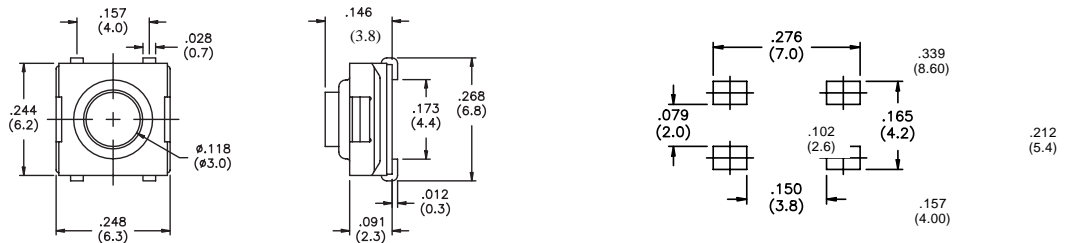

Bulk packaged.

US # MJTPSMW
 Process compatible

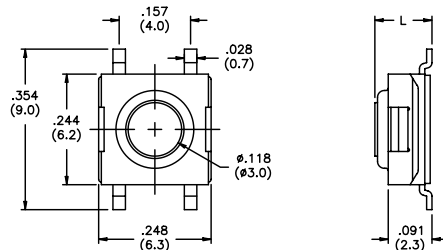

| US Model No. | Dim. L (in./mm) |
|-----------------|-----------------|
| MJTPSMW | .122 (3,1) |
| MJTPSMWA | .091 (2,3) |
| MJTPSMWB | .146 (3,8) |

Bulk packaged.

M

US # MJTPSMWTR & MJTPSMWATR, MJTPSMWBTR

Same as above except supplied on tape & reel as shown.

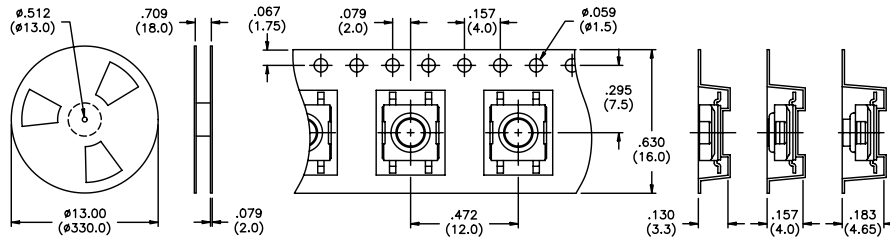

Tape & reel packaging - quantity 'MWTR' & 'MWATR' 2000 per reel, 'MWBTR' 1900 per reel.

SCHEMATICS

MJTP1122
 MJTP1125
 MJTP1137
 MJTP1138
 MJTP1140
 MJTP1162
 MJTPSJW66N
 MJTPSJW69N
 MJTPSMW

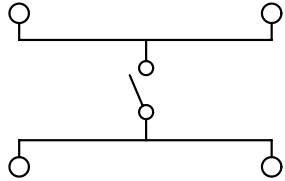

MJTP1106

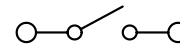

PRINTED CIRCUIT BOARD LAYOUTS

Layout tolerances; Linear: $\pm .004"$ ($\pm 0,1\text{MM}$) Holes: $\pm .002"$ ($\pm 0,05\text{MM}$) Pads: $\pm .008"$ ($\pm 0,2\text{MM}$)

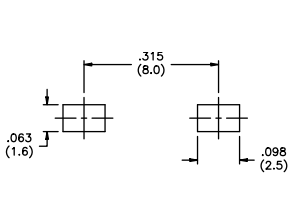

MJTP1106S

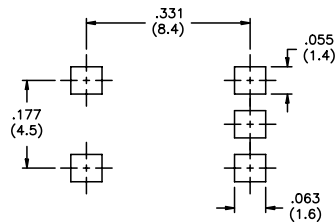

MJTP1122

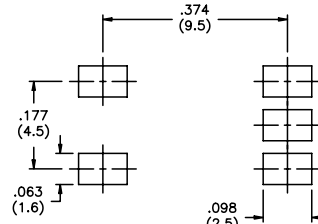

MJTP1122A



MJTP1122B

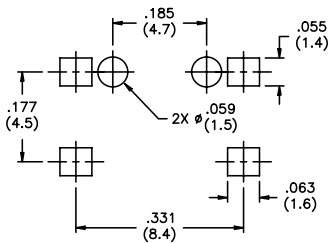

MJTP1137

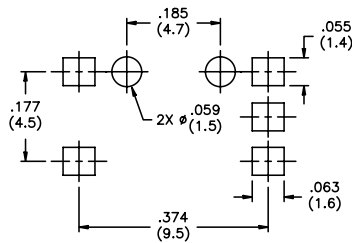

MJTP1137E

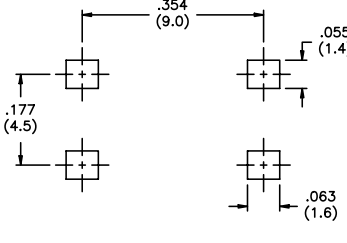

MJTP1138

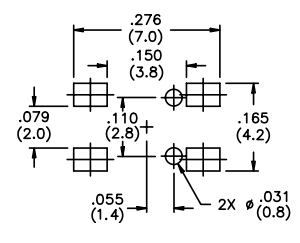

MJTP1140

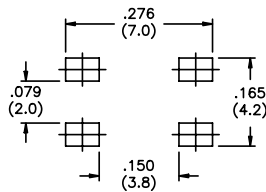

MJTP1140A

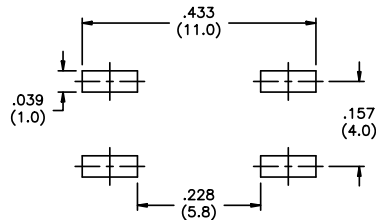

MJTP1162

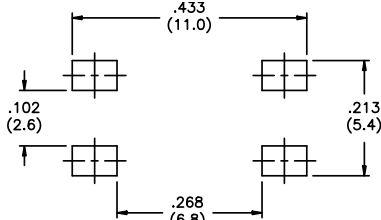

MJTPSMW

M

SPECIFICATIONS SUBJECT TO CHANGE WITHOUT NOTICE.



Компания «ЭлектроПласт» предлагает заключение долгосрочных отношений при поставках импортных электронных компонентов на взаимовыгодных условиях!

Наши преимущества:

- Оперативные поставки широкого спектра электронных компонентов отечественного и импортного производства напрямую от производителей и с крупнейших мировых складов;
- Поставка более 17-ти миллионов наименований электронных компонентов;
- Поставка сложных, дефицитных, либо снятых с производства позиций;
- Оперативные сроки поставки под заказ (от 5 рабочих дней);
- Экспресс доставка в любую точку России;
- Техническая поддержка проекта, помощь в подборе аналогов, поставка прототипов;
- Система менеджмента качества сертифицирована по Международному стандарту ISO 9001;
- Лицензия ФСБ на осуществление работ с использованием сведений, составляющих государственную тайну;
- Поставка специализированных компонентов (Xilinx, Altera, Analog Devices, Intersil, Interpoint, Microsemi, Aeroflex, Peregrine, Syfer, Eurofarad, Texas Instrument, Miteq, Cobham, E2V, MA-COM, Hittite, Mini-Circuits, General Dynamics и др.);

Помимо этого, одним из направлений компании «ЭлектроПласт» является направление «Источники питания». Мы предлагаем Вам помощь Конструкторского отдела:

- Подбор оптимального решения, техническое обоснование при выборе компонента;
- Подбор аналогов;
- Консультации по применению компонента;
- Поставка образцов и прототипов;
- Техническая поддержка проекта;
- Защита от снятия компонента с производства.



Как с нами связаться

Телефон: 8 (812) 309 58 32 (многоканальный)

Факс: 8 (812) 320-02-42

Электронная почта: org@eplast1.ru

Адрес: 198099, г. Санкт-Петербург, ул. Калинина, дом 2, корпус 4, литера А.