

# MJTP SERIES 6MM & 4MM SMD TACT SWITCHES

## FEATURES

- Numerous single pole-single throw momentary configurations.
- Excellent tactile feed-back (Snap dome).
- Ultra-compact size.
- Long operating life for high reliability.
- Molded-in terminals minimize wicking of flux or solder.

## MATERIALS

Case:	High temperature 4/6 nylon.
Actuator:	High temperature 4/6 nylon.
Cover/Bracket:	PET film, tin plated brass or stainless steel.
Terminals:	Silver plated brass.
Shorting Contact:	Phosphor bronze or stainless steel with silver plating.
L.E.D. rating:	Forward voltage- 2.1 V (3.0 V Max.). Cont. fwd. current 20mA max. @ 25°C.

Gold plating available on contacts & terminals  
- consult factory.

SPECIFICATIONS SUBJECT TO CHANGE WITHOUT NOTICE.

## GENERAL SPECIFICATIONS

### ELECTRICALS

Contact rating:	50 mA @ 12 VDC
Insulation resistance:	100 megohms min. (100 VDC)
Dielectric withstanding voltage:	250 VAC for 1 minute
Contact resistance:	100 milliohms max. @ 5 VDC, 10 mA
Electrical life:	100,000 cycles min. (1,000,000 cycles available - consult factory)
Contact bounce:	less than 10 msec.

### MECHANICALS, THERMALS, ENVIRONMENTALS

Plunger travel:	.010" + .008", - .004" (0,25 +0,2, -0,1 mm)
Actuation force:	160 grams ±30 grams
Operating temperature range:	-20°C to +70°C
Storage temperature range:	-30°C to +80°C for 96 hours
Shock resistance:	30G per method 213, MIL-STD-202
Vibration resistance:	passes method 201, MIL-STD-202

### SOLDERING (note - non-washable except for models indicated as 'process compatible').

IR reflow soldering:	240°C max. for 20 seconds max.
Wave soldering:	255°C max. for 5 seconds max.
Hand soldering:	320°C max. for 3.5 seconds max. (40 watt iron max.)

### US # MJTP1106S

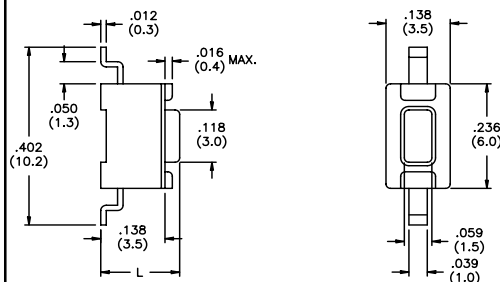

US Model No.	Dim. L (in./mm)
<b>MJTP1106S</b>	.169 (4,3)
<b>MJTP1106SA</b>	.197 (5,0)

Bulk packaged.

### US # MJTP1106SATR

Same as above, except supplied on tape and reel as shown.

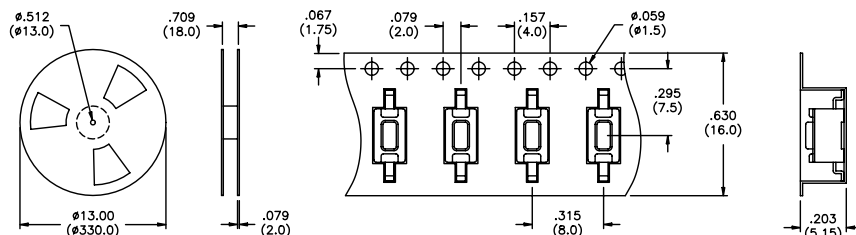

Tape & reel packaging - quantity 1800 per reel.

M

**US # MJTP1122**  
Grounding

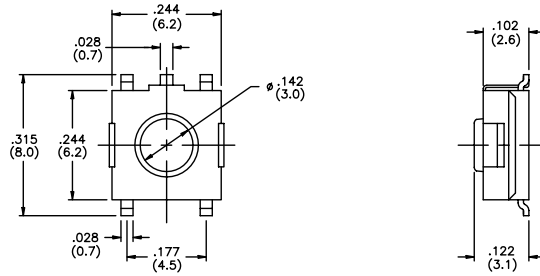

Bulk packaged.

**US # MJTP1122A**  
Grounding

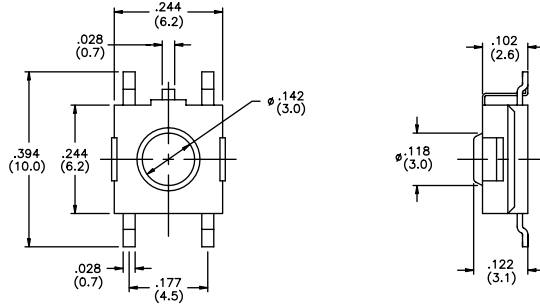

Bulk packaged.

**US # MJTP1122B**  
**EU # PHAP3374**

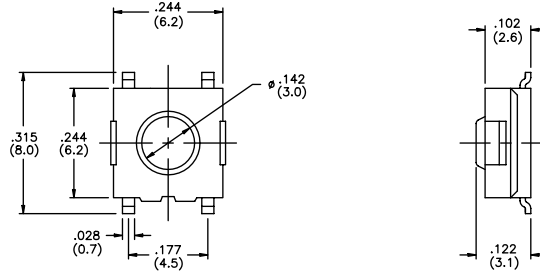

Bulk packaged.

**US # MJTP1122TR,**  
**MJTP1122BTR &**  
**MJTP3374TR**  
**EU # PHAP3374R**

Same as above,  
except supplied  
on tape & reel  
as shown.  
Note -  
MJTP1122A  
not available on  
tape & reel.

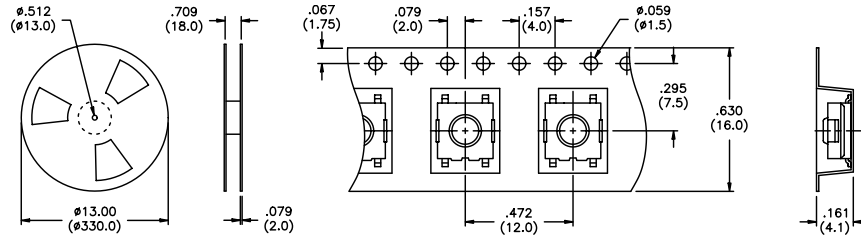

Tape & reel packaging - quantity 1500 per reel.

SPECIFICATIONS SUBJECT TO CHANGE WITHOUT NOTICE.

M

SPECIFICATIONS SUBJECT TO CHANGE WITHOUT NOTICE.

**US # MJTP1125B**

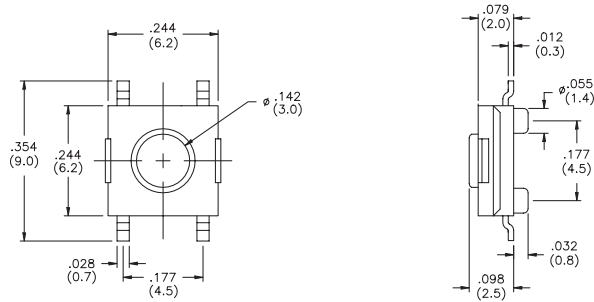

Bulk packaged.

**New!**

**US # MJTP1138  
EU # PHAP3368**

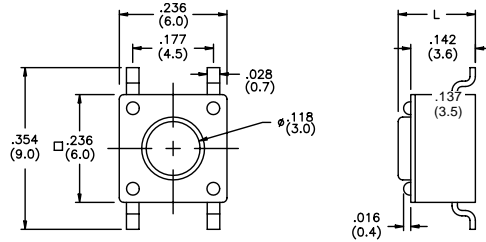

US Model No.	Dim. L (in./mm)	EU Model No.
<b>MJTP1138</b>	.170 (4,3)	<b>PHAP3368</b>
<b>MJTP1138A</b>	.197 (5,0)	<b>PHAP3368A</b>
<b>MJTP1138B</b>	.374 (9,5)	<b>PHAP3368B</b>
<b>MJTP1138C</b>	.315 (8,0)	<b>PHAP3368C</b>
<b>MJTP1138D</b>	.512 (13,0)	<b>PHAP3368D</b>
<b>MJTP1138E</b>	.287 (7,3)	<b>PHAP3368E</b>
<b>MJTP1138F</b>	.335 (8,5)	<b>PHAP3368F</b>
<b>MJTP1138G</b>	.275 (7,0)	N/A

Bulk packaged. Tubes available for some models consult factory.

SPECIFICATIONS SUBJECT TO CHANGE WITHOUT NOTICE.

**US # MJTP1138TR & MJTP1138ATR**

Same as above except supplied on tape & reel as shown.

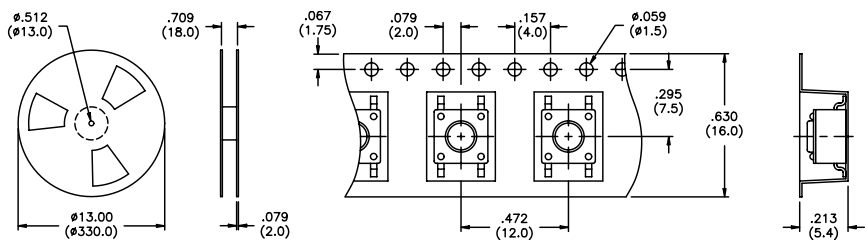

Tape & reel packaging - quantity 1200 per reel.

**US # MJTP1140 EU # PHAP3390**

4mm x 4mm

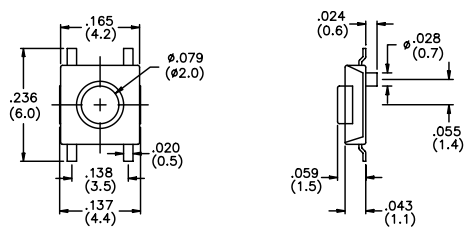

Bulk packaged.

**US # MJTP1140A EU # PHAP3391**

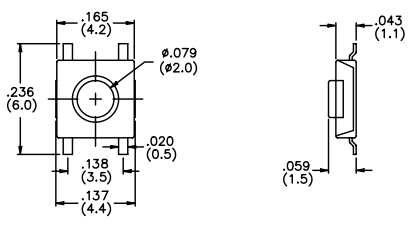

Bulk packaged.

**US # MJTP1140TR & MJTP1140ATR EU # PHAP3390R & PHAP3391R**

Same as above, except supplied on tape & reel as shown.

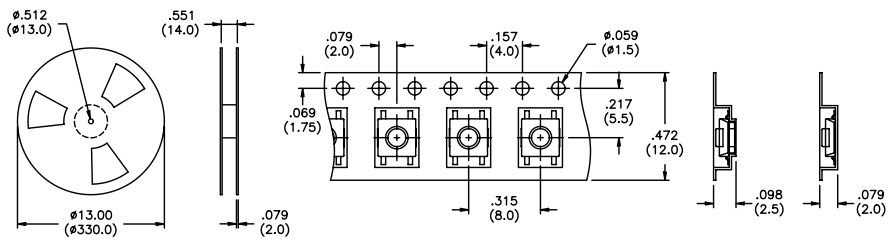

Tape & reel packaging - quantity 3400 per reel.

**US # MJTP1162 EU # PHAP3371**

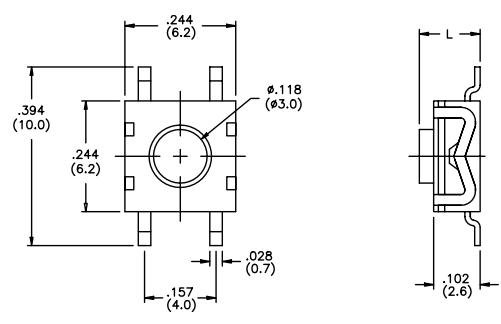

US Model No.	Dim. L (in./mm)	EU Model No.
<b>MJTP1162</b>	.102 (2,6)	<b>PHAP3371</b>
<b>MJTP1162A</b>	.134 (3,4)	<b>PHAP3371A</b>

Bulk packaged.

SPECIFICATIONS SUBJECT TO CHANGE WITHOUT NOTICE.

**US # MJTP1162TR & MJTP1162ATR**  
**EU # PHAP3371R & PHAP3371AR**  
 Same as above except supplied on tape & reel as shown.

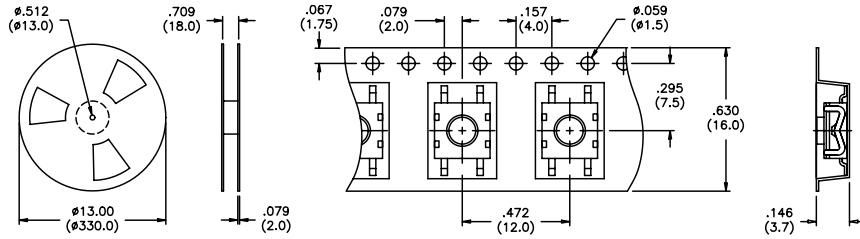

Tape & reel packaging - quantity 1600 per reel.

**US # MJTPSJW66N**  
 Process compatible



**New!**

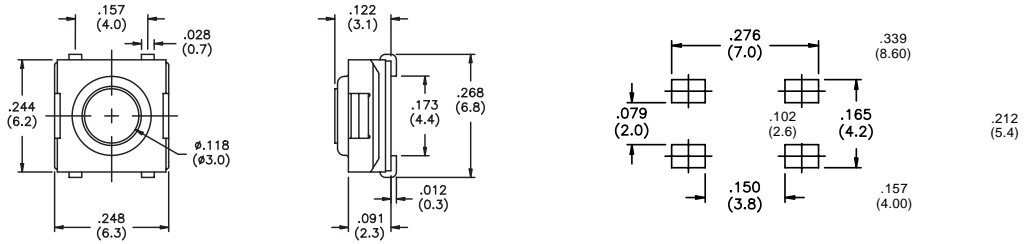

Bulk packaged.

**US # MJTPSJW69N**  
 Process compatible



**New!**

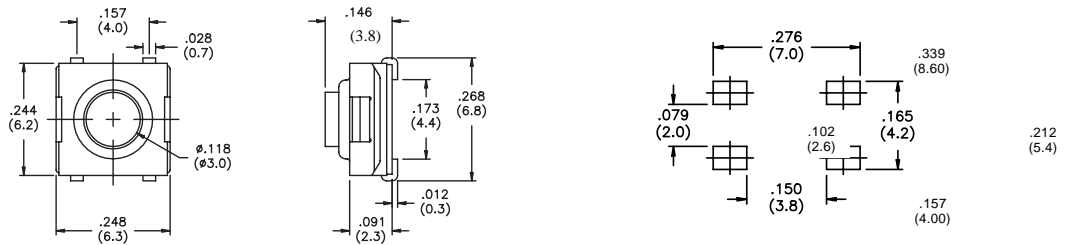

Bulk packaged.

**US # MJTPSMW**  
 Process compatible

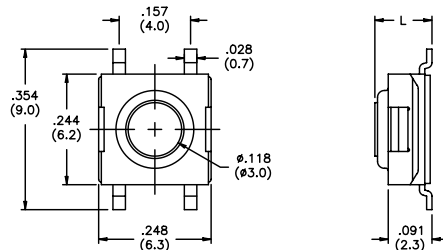

US Model No.	Dim. L (in./mm)
<b>MJTPSMW</b>	.122 (3,1)
<b>MJTPSMWA</b>	.091 (2,3)
<b>MJTPSMWB</b>	.146 (3,8)

Bulk packaged.

**M**

**US # MJTPSMWTR & MJTPSMWATR, MJTPSMWBTR**

Same as above except supplied on tape & reel as shown.

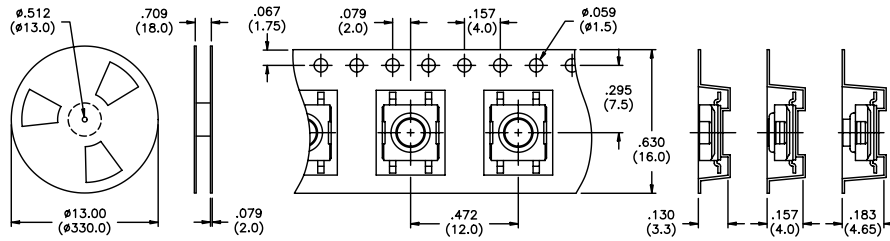

Tape & reel packaging - quantity 'MWTR' & 'MWATR' 2000 per reel, 'MWBTR' 1900 per reel.

**SCHEMATICS**

MJTP1122  
 MJTP1125  
 MJTP1137  
 MJTP1138  
 MJTP1140  
 MJTP1162  
 MJTPSJW66N  
 MJTPSJW69N  
 MJTPSMW

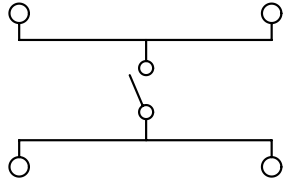

MJTP1106

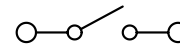

**PRINTED CIRCUIT BOARD LAYOUTS**

Layout tolerances; Linear:  $\pm .004"$  ( $\pm 0,1\text{MM}$ ) Holes:  $\pm .002"$  ( $\pm 0,05\text{MM}$ ) Pads:  $\pm .008"$  ( $\pm 0,2\text{MM}$ )

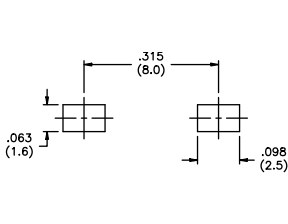

MJTP1106S

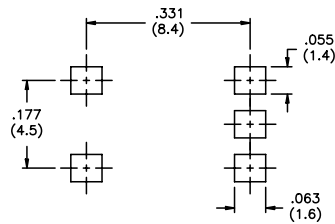

MJTP1122

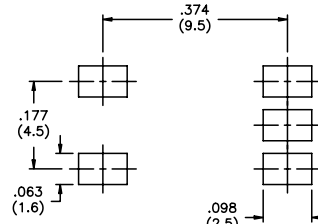

MJTP1122A

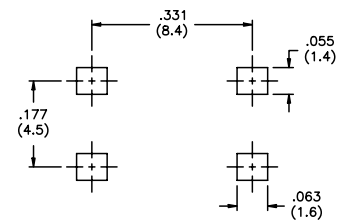

MJTP1122B

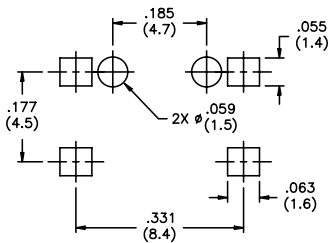

MJTP1137

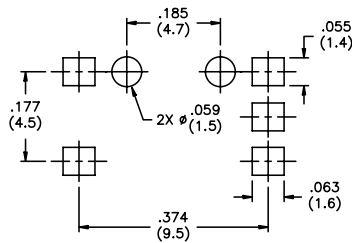

MJTP1137E

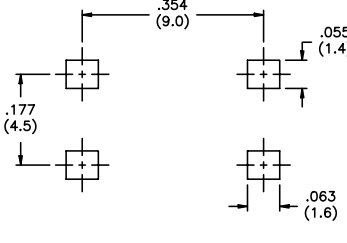

MJTP1138

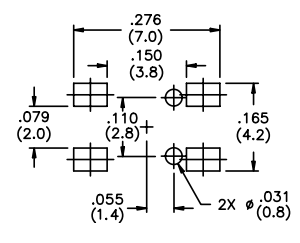

MJTP1140

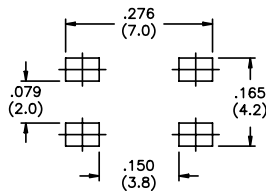

MJTP1140A

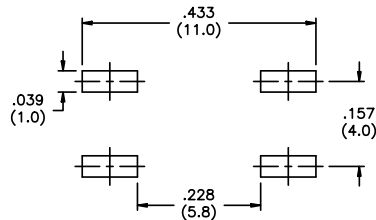

MJTP1162

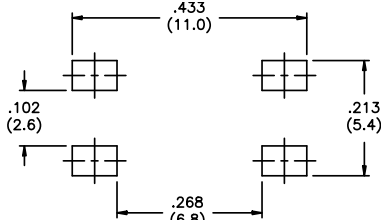

MJTPSMW

M

SPECIFICATIONS SUBJECT TO CHANGE WITHOUT NOTICE.



Компания «ЭлектроПласт» предлагает заключение долгосрочных отношений при поставках импортных электронных компонентов на взаимовыгодных условиях!

Наши преимущества:

- Оперативные поставки широкого спектра электронных компонентов отечественного и импортного производства напрямую от производителей и с крупнейших мировых складов;
- Поставка более 17-ти миллионов наименований электронных компонентов;
- Поставка сложных, дефицитных, либо снятых с производства позиций;
- Оперативные сроки поставки под заказ (от 5 рабочих дней);
- Экспресс доставка в любую точку России;
- Техническая поддержка проекта, помощь в подборе аналогов, поставка прототипов;
- Система менеджмента качества сертифицирована по Международному стандарту ISO 9001;
- Лицензия ФСБ на осуществление работ с использованием сведений, составляющих государственную тайну;
- Поставка специализированных компонентов (Xilinx, Altera, Analog Devices, Intersil, Interpoint, Microsemi, Aeroflex, Peregrine, Syfer, Eurofarad, Texas Instrument, Miteq, Cobham, E2V, MA-COM, Hittite, Mini-Circuits, General Dynamics и др.);

Помимо этого, одним из направлений компании «ЭлектроПласт» является направление «Источники питания». Мы предлагаем Вам помощь Конструкторского отдела:

- Подбор оптимального решения, техническое обоснование при выборе компонента;
- Подбор аналогов;
- Консультации по применению компонента;
- Поставка образцов и прототипов;
- Техническая поддержка проекта;
- Защита от снятия компонента с производства.



#### Как с нами связаться

**Телефон:** 8 (812) 309 58 32 (многоканальный)

**Факс:** 8 (812) 320-02-42

**Электронная почта:** [org@eplast1.ru](mailto:org@eplast1.ru)

**Адрес:** 198099, г. Санкт-Петербург, ул. Калинина, дом 2, корпус 4, литера А.