

# General Specifications

## Electrical Capacity (Resistive Load)

**Power Level (silver):** 6A @ 125V AC & 3A @ 250V AC

4A @ 30V DC for On-None-On & On-None-Off; 3A @ 30V DC for all other circuits

**Logic Level (gold):** 0.4VA maximum @ 28V AC/DC maximum (Applicable Range 0.1mA ~ 0.1A @ 20mV ~ 28V)

**Logic/Power Level (gold over silver):** Combines silver & gold ratings

Note: Find additional explanation of dual rating & operating range in Supplement section.

## Other Ratings

**Contact Resistance:** 10 milliohms maximum for silver; 20 milliohms maximum for gold

**Insulation Resistance:** 1,000 megohms minimum @ 500V DC

**Dielectric Strength:** 1,000V AC minimum between contacts for 1 minute minimum;  
1,500V AC minimum between contacts and case for 1 minute minimum

**Mechanical Life:** 100,000 operations minimum; 50,000 operations minimum for flat, locking & splashproof devices

**Electrical Life:** 25,000 operations minimum for silver; 50,000 operations minimum for gold;

50,000 operations minimum for silver at 3A @ 125V AC

**Angle of Throw:** 25°

## Materials & Finishes

**Toggle:** Brass with chrome plating

**Frame:** Stainless steel

**Bushing:** Brass with nickel plating

**Support Bracket:** Brass with tin plating

**Case:** Diallyl phthalate resin (UL94V-0)

**Movable Contactor:** Phosphor bronze with silver or gold plating

**Movable Contacts:** Silver alloy (code W); copper with gold plating (code G); or silver alloy with gold plating (code A)

**Stationary Contacts:** Silver with silver plating (code W); copper or brass with gold plating (code G);  
or silver with gold plating (code A)

**Terminals:** Copper or brass with silver plating; or copper or brass with gold plating

## Environmental Data

**Operating Temp Range:** -30°C through +85°C (-22°F through +185°F)

**Humidity:** 90 ~ 95% humidity for 96 hours @ 40°C (104°F)

**Vibration:** 10 ~ 55Hz with peak-to-peak amplitude of 1.5mm traversing the frequency range & returning  
in 1 minute; 3 right angled directions for 2 hours

**Shock:** 50G (490m/s<sup>2</sup>) acceleration (tested in 6 right angled directions, with 5 shocks in each direction)

**Sealing:** Splashproof bushing options B3, D3, D8, L3, & L8, which have o-rings inside & outside the  
bushing, meet IP67 of IEC60529 Standards.

## Installation

**Mounting Torque:** 3.0Nm (26.55 lb•in) double nut for large bushing;  
1.5Nm (13 lb•in) double nut & 0.7Nm (6 lb•in) single nut for all other bushings

## Processing

**Soldering:** Wave Soldering (PC version) for Gold: See Profile A in Supplement section.

Manual Soldering for Gold: See Profile A in Supplement section.

Wave Soldering (PC version) for Silver: See Profile B in Supplement section.

Manual Soldering for Silver: See Profile B in Supplement section.

Note: Lever must be in OFF (center) position while soldering.

**Cleaning:** These devices are not process sealed. Hand clean locally using alcohol based solution.

## Standards & Certifications

**Flammability Standards:** UL94V-0 for case

**UL:** File No. E44145 - Recognized only when ordered with marking on switch.

Add "/U" or "/CUL" before dash in part number to order UL recognized switch.

All models recognized at 6A @ 125V AC, 3A @ 250V AC or 0.4VA maximum @ 28V DC maximum.

**CSA:** File No. 023535\_0\_000 - Certified only when ordered with marking on switch.

Add "/C" before dash in part number to order CSA certified switch.

All models certified at 6A @ 125V AC or 3A @ 250V AC or 0.4VA maximum @ 28V maximum.

# Distinctive Characteristics

Antirotation design, standard on noncylindrical levers, mates toggle and bushing; bottom of toggle has two flattened sides which fit into a complementary opening inside bushing.

Antijamming design protects contacts from damage due to excessive downward force on actuator.

High torque bushing construction prevents rotation or separation from frame during installation.

High insulating barriers increase isolation of circuits in multipole devices and provide added protection to contact points.

Molded diallyl phthalate case has a UL flammability rating of 94V-0.

Epoxy sealed terminals prevent entry of solder flux and other contaminants.

Prominent external insulating barriers increase insulation resistance and dielectric strength.

Interlocked actuator block, lever, and interior guide prevent switch failure due to biased lever movement.

Clinching of frame to case well above base and terminals provides 1,500V dielectric strength.

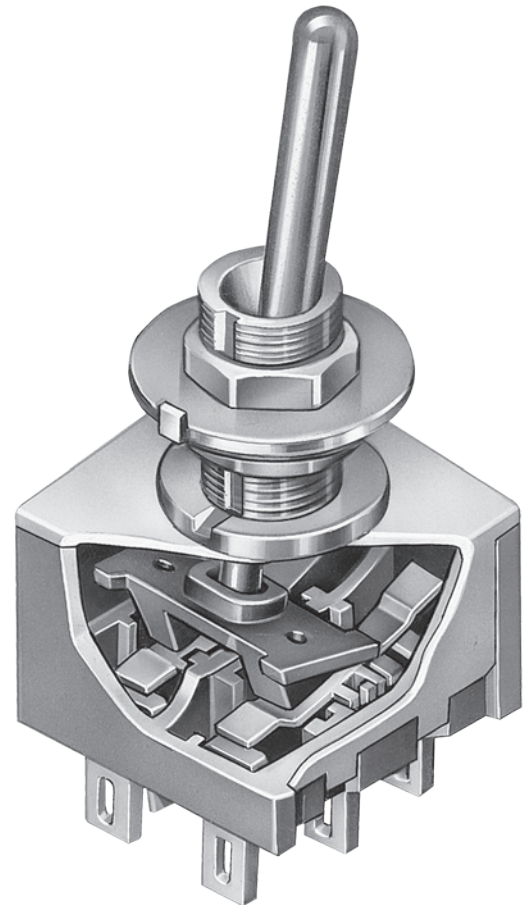

Actual Size

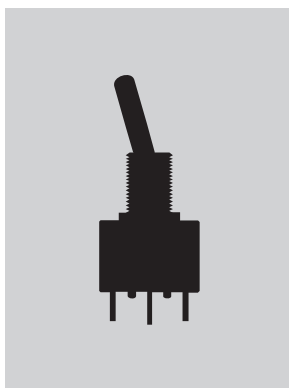

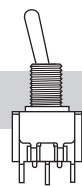
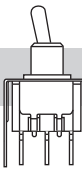
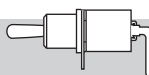
	Bushing Mount	Page A48
	Bracket PC Mount	Page A60
	Angle PC Mount	Page A66

A Toggles

Rockers

Pushbuttons

Illuminated PB

Programmable

Keylocks

Rotaries

Slides

Tactiles

Tilt

Touch

Indicators

Accessories

Supplement

**M20**

**1**

**3**

**S**

**S1**

Poles	
1	SPST SPDT
2	DPST DPDT SP3T
3	3PDT
4	4PDT DP3T

Small Toggles	
<b>S</b>	.413" (10.5mm) Bat
<b>S2</b>	.200" (5.08mm) Bat
<b>S3</b>	.256" (6.5mm) Bat
<b>E</b>	.450" (11.4mm) Flatted
<b>* E2</b>	.256" (6.5mm) Flatted
<b>E4</b>	.840" (21.3mm) Flatted
<b>* Q</b>	.550" (14.0mm) Cone
<b>* Q2</b>	.640" (16.26mm) Cone
<b>* Q4</b>	.840" (21.3mm) Cone
<b>* C</b>	.571" (14.5mm) Color Tipped Cone
<b>D</b>	.840" (21.3mm) Color Capped Cone

Specify cap color for toggles C & D at the end of the part number.  
\* Available on 1- and 2-pole only.

Small Bushings	
<b>S1</b>	.350" (8.9mm) Threaded with Keyway
<b>S4</b>	6mm .350" (8.9mm) Threaded with Keyway
<b>S2</b>	.350" (8.9mm) Smooth with Keyway
<b>A1</b>	.280" (7.1mm) Threaded with Keyway
<b>A2</b>	.280" (7.1mm) Smooth with Keyway
<b>D1</b>	.350" (8.9mm) Threaded with D Flat
<b>D4</b>	6mm .350" (8.9mm) Threaded with D Flat
<b>D3</b>	.350" (8.9mm) Threaded Splashproof with D Flat (combines only with S, S2 & S3)
<b>D8</b>	6mm .350" (8.9mm) Threaded Splashproof with D Flat (combines only with S, S2 & S3)

Circuits			
<b>* 1</b>	ON	NONE	OFF
<b>2</b>	ON	NONE	ON
<b>3</b>	ON	OFF	ON
<b>5</b>	ON	NONE	(ON)
<b>8</b>	(ON)	OFF	(ON)
<b>9</b>	ON	OFF	(ON)
<b>**4</b>	ON	ON	ON
<b>**6</b>	(ON)	ON	(ON)
<b>**7</b>	ON	ON	(ON)

( ) = Momentary

\* ON-NONE-OFF circuit available in 1- and 2-pole only.

\*\* 3-ON circuits

Large Toggles	
<b>B</b>	.453" (11.5mm) Large Bat
<b>B2</b>	.689" (17.5mm) Large Bat
<b>R</b>	.610" (15.5mm) Large Flatted

Large Bushings	
<b>B1</b>	Large .472" (12mm) Threaded with Keyway
<b>B3</b>	Large .472" (12mm) Threaded Splashproof with D Flat

Locking Lever	
<b>L</b>	.201" (5.1mm) Dia. Locking Lever

Bushings For Locking Levers	
<b>L1</b>	.291" (7.4mm) Threaded with Keyway for Lever Lock
<b>L4</b>	6mm .291" (7.4mm) Threaded with Keyway for Lever Lock
<b>L2</b>	Smooth with Keyway for Lever Lock
<b>L3</b>	.295" (7.5mm) Threaded Splashproof with D Flat for Lever Lock
<b>L8</b>	6mm .295" (7.5mm) Threaded Splashproof with D Flat for Lever Lock

#### IMPORTANT:



Switches are supplied without UL, cULus & CSA marking unless specified.  
**UL, cULus & CSA recognized only when ordered with marking on the switch.**  
Specific models, ratings, & ordering instructions are noted on General Specifications page.

## ORDERING EXAMPLE

Contact Materials & Ratings		Optional Caps		Cap Colors	
<b>W</b>	Silver; Rated 6A @ 125V AC & 3A @ 250V AC	<b>For Small Bat Toggles</b>		<b>A</b>	Black
<b>G</b>	Gold; Rated 0.4VA max @ 28V AC/DC max	<b>B</b>	For S Bat Toggle	<b>B</b>	White
<b>A</b>	Gold over Silver; Rated 6A @ 125V AC & 0.4VA max @ 28V AC/DC max	<b>C</b>	Conical Cap for S Bat Toggle	<b>C</b>	Red
		<b>For Large Bat Toggles</b>		<b>E</b>	Yellow
		<b>R</b>	For B Toggle	<b>F</b>	Green
		<b>V</b>	For B2 Toggle	<b>G</b>	Blue
				<b>H</b>	Gray (for K1 & K2 paddles)

  

Terminals		Cap for Locking Lever	
<b>01</b>	Solder Lug*	<b>No Code</b>	Nickel Plated Supplied with Switch
<b>02</b>	Quick Connect	<b>A</b>	Black
<b>03</b>	.250" (6.35mm) Straight PC	<b>C</b>	Red
<b>05</b>	.425" (10.8mm) Wirewrap	<b>G</b>	Blue
<b>06</b>	.750" (19.05mm) Wirewrap		
<b>07</b>	.964" (24.5mm) Wirewrap		
<b>08</b>	1.062" (27.0mm) Wirewrap		







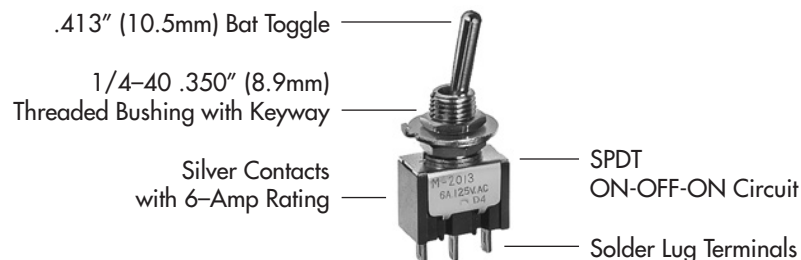





\* Wire harness & cable assemblies offered only in Americas

### DESCRIPTION FOR TYPICAL ORDERING EXAMPLE

**M2013SS1W01**

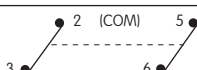

## POLES & CIRCUITS

Pole	Model	Toggle Position ( ) = Momentary			Connected Terminals			Throw & Schematics
		Down 	Center 	Up 	Down 	Center 	Up 	
SP	M2011	ON	NONE	OFF	2-3	OPEN	OPEN	SPST 
SP	M2012 M2013 M2015 M2018 M2019	ON ON ON (ON) ON	NONE OFF NONE OFF OFF	ON ON (ON) (ON) (ON)	2-3	OPEN	2-1	SPDT 
DP	M2021	ON	NONE	OFF	2-3 5-6	OPEN	OPEN	DPST 
DP	M2022 M2023 M2025 M2028 M2029	ON ON ON (ON) ON	NONE OFF NONE OFF OFF	ON ON (ON) (ON) (ON)	2-3 5-6	OPEN	2-1 5-4	DPDT 
3P	M2032 M2033 M2035 M2038 M2039	ON ON ON (ON) ON	NONE OFF NONE OFF OFF	ON ON (ON) (ON) (ON)	2-3 5-6 8-9	OPEN	2-1 5-4 8-7	3PDT 
4P	M2042 M2043 M2045 M2048 M2049	ON ON ON (ON) ON	NONE OFF NONE OFF OFF	ON ON (ON) (ON) (ON)	2-3 5-6 8-9 11-12	OPEN	2-1 5-4 8-7 11-10	4PDT 

### For 3 Throw (3-On)

#### Connected Terminals & Schematic

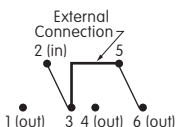
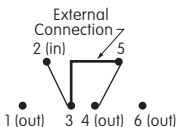
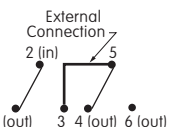
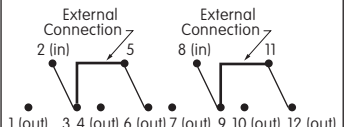
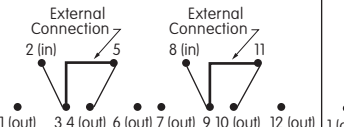
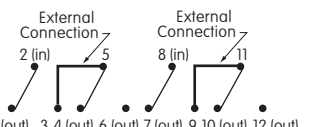
Pole	Model	Down	Center	Up	Down	Center	Up
SP	M2024 M2026 M2027	ON (ON) ON	ON ON ON	ON (ON) (ON)			
DP	M2044 M2046 M2047	ON (ON) ON	ON ON ON	ON (ON) (ON)			

The SP3T model utilizes a double pole base.

External connection must be made during field installation.

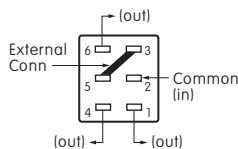

The DP3T model utilizes a four pole base.

External connection must be made during field installation.

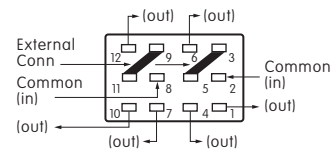

## SMALL TOGGLES

**S** .413" (10.5mm)  
Bat

**S2** .200" (5.08mm)  
Bat

**S3** .256" (6.5mm)  
Bat

### Important:

Toggle length changes based on bushing selected. All illustrations are shown with .350" long bushing. When using a .280" long bushing, toggle length increases .070".

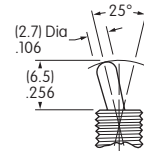
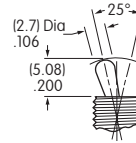
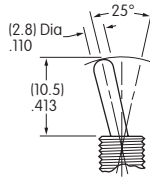

**Standard Material & Finish:** Brass with Bright Chrome  
Contact factory for optional finishes.

**E** .450" (11.4mm)  
Flatted

**E2** .256" (6.5mm)  
Flatted

**E4** .840" (21.3mm)  
Flatted

**C** .571" (14.5mm)  
Color Tipped Cone  
Supplied with Cap AT445

Material: Polycarbonate

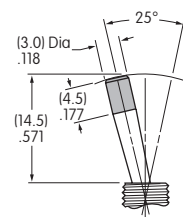
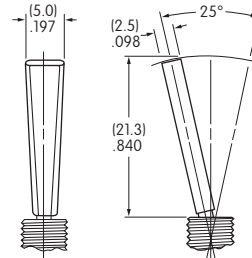
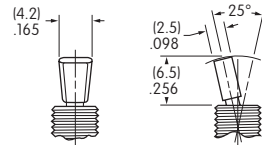
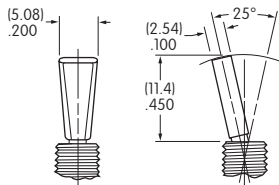

Only Available in 1- & 2-Pole

Only Available in 1- & 2-Pole

**Q** .550" (14.0mm)  
Cone

**Q2** .640" (16.26mm)  
Cone

**Q4** .840" (21.3mm)  
Cone

**D** .840" (21.3mm)  
Color Capped Cone  
Supplied with Cap AT460

Material: Polyethylene

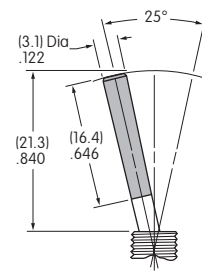
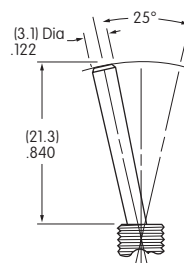
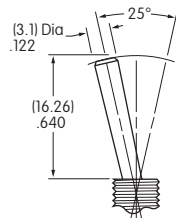
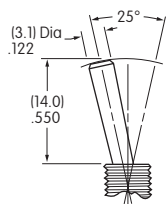

Only Available in 1- & 2-Pole

Only Available in 1- & 2-Pole

Only Available in 1- & 2-Pole

Cap Colors Available:

**A**

Black

**B**

White

**C**

Red

**E**

Yellow

**F**

Green

**G**

Blue

**H**

Gray  
(For K1 & K2 only)

## SMALL BUSHINGS

**S1** 1/4-40 .350" (8.9mm)  
Threaded with Keyway

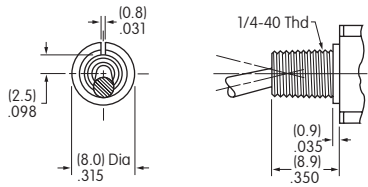

Maximum Panel Thickness with Standard Hardware: .102" (2.6mm)

**S4** 6mm/.350" (8.9mm)  
Threaded with Keyway

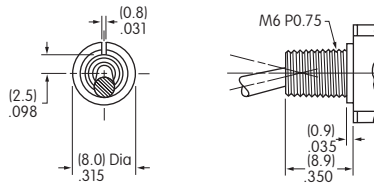

Maximum Panel Thickness with Standard Hardware: .102" (2.6mm)

**S2** .350" (8.9mm)  
Smooth with Keyway

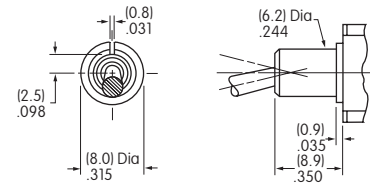

**A1** 1/4-40 .280" (7.1mm)  
Threaded with Keyway

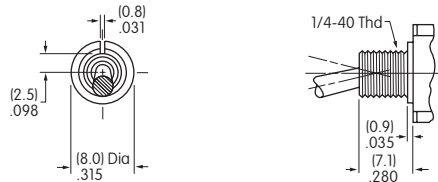

When using this bushing, toggle length is increased by .070". Maximum Panel Thickness with Standard Hardware: .031" (0.8mm)

**A2** .280" (7.1mm)  
Smooth with Keyway

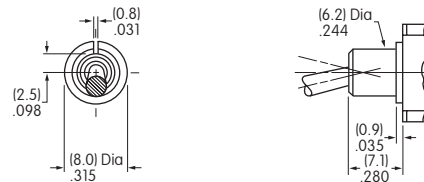

When using this bushing, toggle length is increased by .070".

**D1** 1/4-40 .350" (8.9mm)  
Threaded with D Flat

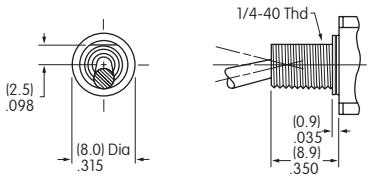

Maximum Panel Thickness with Standard Hardware: .102" (2.6mm)

**D4** 6mm/.350" (8.9mm)  
Threaded with D Flat

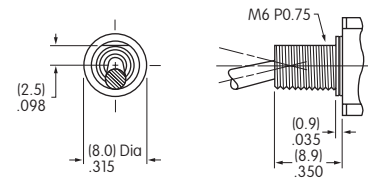

Maximum Panel Thickness with Standard Hardware: .102" (2.6mm)

**D3** 1/4-40 .350" (8.9mm)  
Threaded Splashproof with D Flat

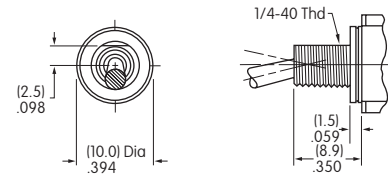

D3 combines only with S, S2 & S3 toggles. Maximum Panel Thickness with Standard Hardware: .193" (4.9mm)

**D8** 6mm/.350" (8.9mm)  
Threaded Splashproof with D Flat

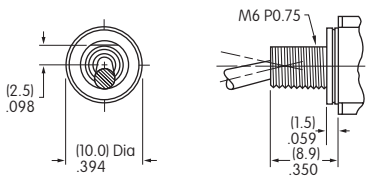

D8 combines only with S, S2 & S3 toggles. Maximum Panel Thickness with Standard Hardware: .193" (4.9mm)

### Standard Hardware Supplied for Small Bushings

Bushing Codes	S1/S4	A1	D1/D4	D3/D8	L1/L4	L3/L8
Hex Nut	2	2	2	1	2	1
Locking Ring	1	1	0	0	1	0
Lockwasher	1	1	1	0	1	0
O-ring	0	0	0	1	0	1

For S1, S2, A1, A2 or S4 Bushing with Keyway & for L1 or L4 Bushing

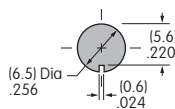

For S1, A1 or S4 Bushing with Locking Ring & for L1 or L4 Bushing

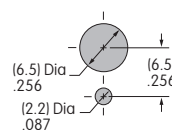

For D1, D4, D3 or D8 Bushing with D Flat & for L3 or L8 Bushing

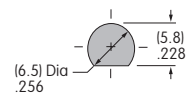

## LARGE TOGGLES

**Toggle & Bushing Combinations:** These toggles combine with the 12mm bushings B1 & B3.

**B** .453" (11.5mm)  
Large Bat

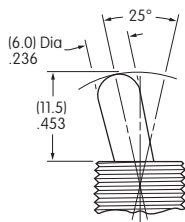

**B2** .689" (17.5mm)  
Large Bat

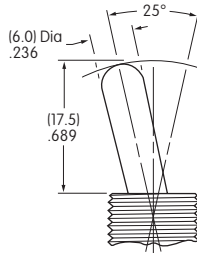

**R** .610" (15.5mm)  
Large Flatted

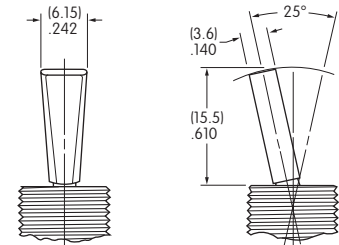

**Standard Material & Finish:** Brass with Bright Chrome  
Optional Finishes: Contact factory for satin chrome or black.

## LARGE BUSHINGS

**B1** Large .472" (12.0mm)  
Threaded with Keyway

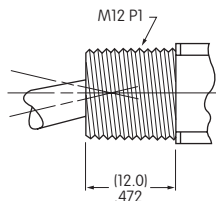
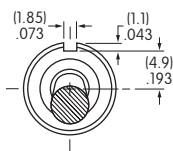

Maximum Panel Thickness with  
Standard Hardware: .216" (5.5mm)

**Standard Hardware for B1:**  
1 hex face nut AT503M, 1 locking ring AT506M,  
1 lockwasher AT508, and 1 hex backup nut AT527M

**B3** Large .472" (12.0mm)  
Threaded Splashproof with D Flat

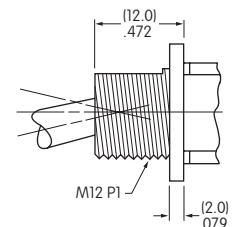
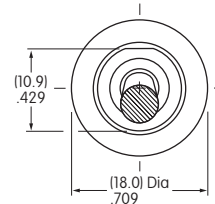

Maximum Panel Thickness with  
Standard Hardware: .256" (6.5mm)

**Standard Hardware for B3:**  
1 hex face nut AT503M  
and 1 o-ring AT401P

### Panel Cutouts

**For B1 Bushing  
with Keyway**

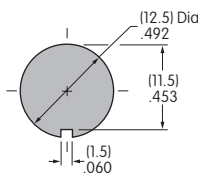

**For B1 Bushing  
with Locking Ring**

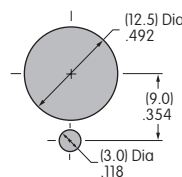

**For B3 Bushing  
with D Flat**

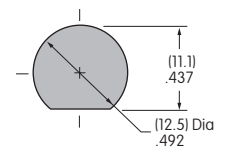



## LOCKING LEVER & BUSHINGS

**LL1** 1/4-40 .291" (7.4mm)  
Threaded with Keyway

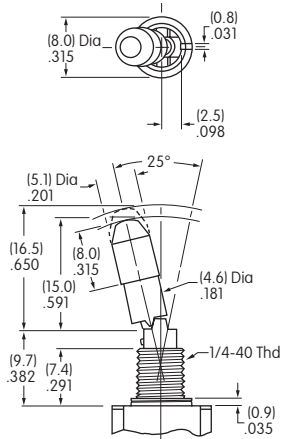

**LL4** 6mm/.291" (7.4mm)  
Threaded with Keyway

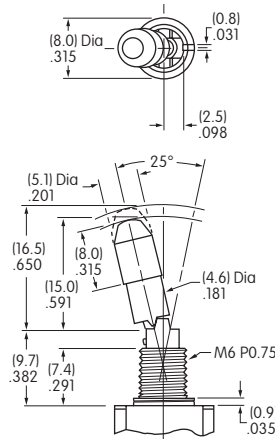

**LL2** Smooth with Keyway

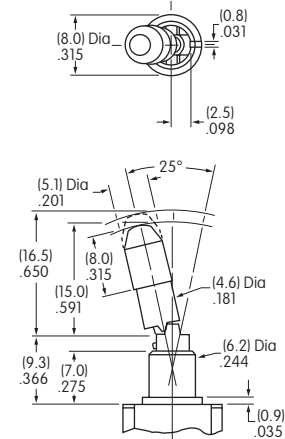

Maximum Panel Thickness with Standard Hardware: .047" (1.2mm)  
Standard Hardware for L1 & L4: 2 hex nuts AT513H or AT513M,  
1 locking ring AT507H or AT507M, and 1 lockwasher AT509

**LL3** 1/4-40 .295" (7.5mm)  
Threaded Splashproof with D Flat

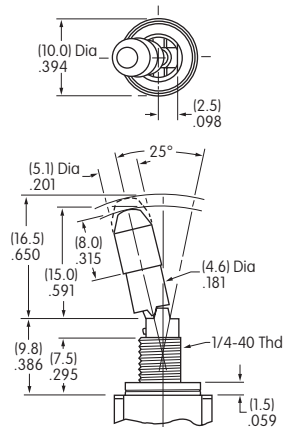

**LL8** 6mm/.295" (7.5mm)  
Threaded Splashproof with D Flat

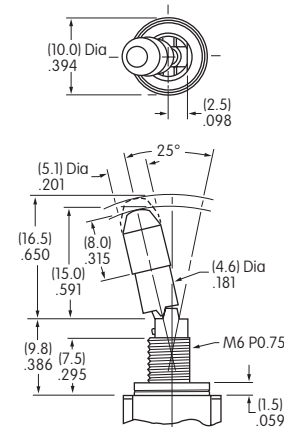

Maximum Panel Thickness with Standard Hardware: .047" (1.2mm)  
Standard Hardware for L3 and L8: 1 hex nut AT513H or AT513M and 1 o-ring AT516

Lever Material & Finish: Brass with Chrome Plating

### Locking Mechanism

on-none-on



2 positions lock

on-none-(on)



1 position locks

on-off-(on)  
on-on-(on)



2 positions lock

on-off-on  
on-on-on

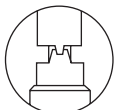

3 positions lock

(on)-off-(on)  
(on)-on-(on)

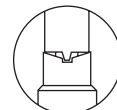

1 position locks

**No Code**

Supplied with Cap AT427

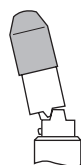

Lever

Color Codes for Optional Anodized Aluminum Caps

Cap Material:  
Brass with Nickel Plating

**A** Black

**C** Red

**G** Blue

## CONTACT MATERIALS & RATINGS

<b>W</b>	Silver over Silver	Power Level	6A @ 125V AC & 3A @ 250V AC
<b>G</b>	Gold over Brass or Copper	Logic Level	6A @ 125V AC & 3A @ 250V AC
Note: See Supplement section to find complete explanation of operating range.			
<b>A</b>	Gold over Silver	Power Level or Logic Level	6A @ 125V AC or 0.4VA maximum @ 28V AC/DC maximum
Note: This dual rated option is suitable when two or more identical switches are used in logic and in power circuits within the same application. See Supplement section to find complete explanation of dual rating and operating range.			

## TERMINALS

<b>01</b>	Solder Lug		<b>02</b>	.062" (1.57mm) Wide Quick Connect		
<b>03</b>	.250" (6.35mm) Straight PC					
<b>05</b>	.425" (10.8mm) Wirewrap or Extended PC	<b>07</b>	.964" (24.5mm) Wirewrap or Extended PC		Dimension A = terminal lengths as shown beside the terminal codes at the left.	
<b>06</b>	.750" (19.05mm) Wirewrap or Extended PC	<b>08</b>	1.062" (27.0mm) Wirewrap or Extended PC			
If using as extended PC terminal, refer to the above footprints.						

## OPTIONAL CAPS & CAP COLORS

<b>B</b>	AT415 Lever Cap for S Bat Toggle	<b>C</b>	AT444 Conical Cap for S Bat Toggle	<b>R</b>	AT434 Lever Cap for B Toggle	<b>V</b>	AT406 Lever Cap for B2 Toggle
Material: Polyethylene		Material: Polyethylene		Material: Polyvinyl Chloride		Material: Polyvinyl Chloride	

Cap Colors Available: **A** Black **B** White **C** Red **E** Yellow **F** Green **G** Blue

## TYPICAL SWITCH DIMENSIONS

### Solder Lug

### Single Pole

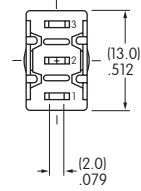
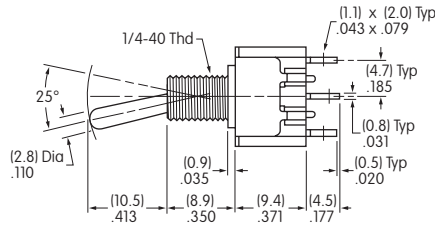
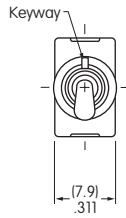

**M2012SS1W01**

M2011 model does not have terminal 1.

### Solder Lug

### Double Pole

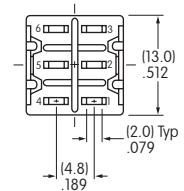
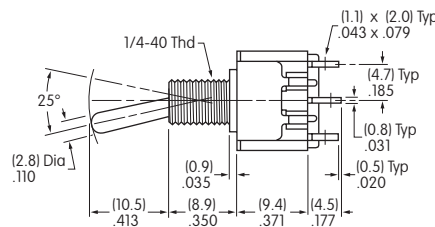
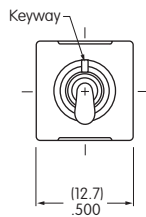

**M2022SS1W01**

M2021 model does not have terminals 1 & 4.

### Solder Lug

### Three Pole

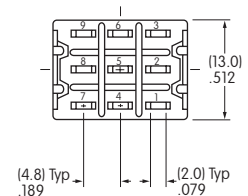
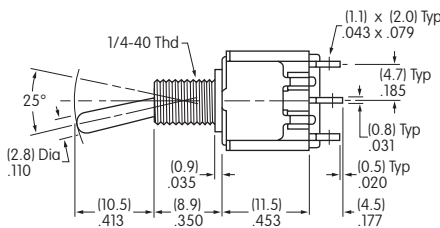
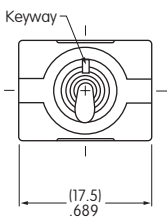

**M2032SS1W01**

### Solder Lug

### Four Pole

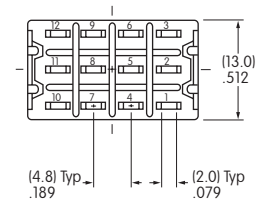
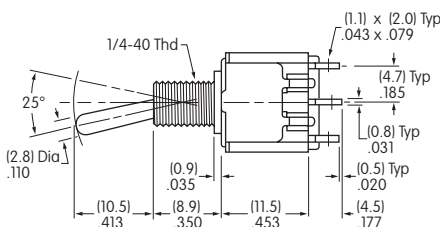
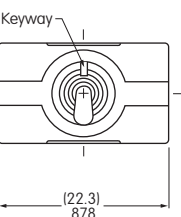

**M2042SS1W01**

Rockers

Pushbuttons

Illuminated PB

Programmable

Keylocks

Rotaries

Slides

Tactiles

Tilt

Touch

Indicators

Accessories

Supplement

## STANDARD HARDWARE FOR SMALL & LARGE BUSHINGS

**AT513H for Inch  
AT513M for Metric  
Hex Nut**  
Brass/Nickel

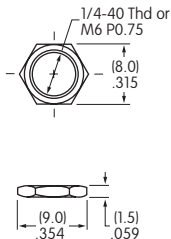

**AT507H for Inch  
AT507M for Metric  
Locking Ring**  
Steel with Zinc/Chrome

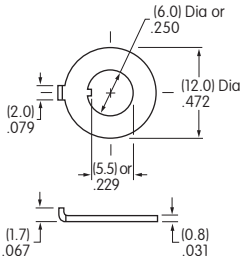

**AT509  
Lockwasher**  
Steel with Zinc/Chrome  
(not supplied with splashproof models)

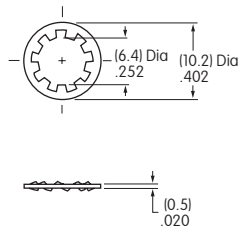

**AT516  
O-ring for  
Splashproof Models**  
Nitrile Butadiene Rubber

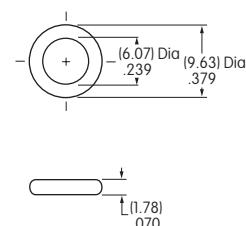

**AT503M  
Hex Face Nut**  
Brass/Chrome

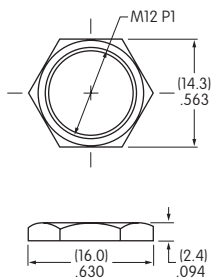

**AT506M  
Locking Ring**  
Steel with Zinc/Chrome

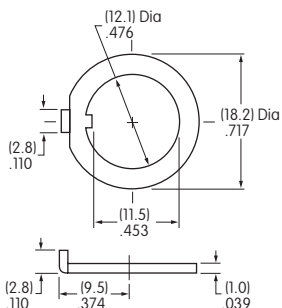

**AT508  
Lockwasher**  
Steel with Zinc/Chrome  
(not supplied with splashproof models)

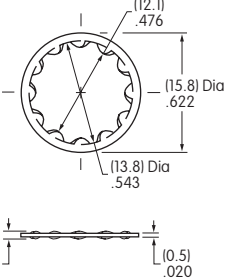

**AT527M  
Hex Nut**  
Steel with  
Nickel Plating

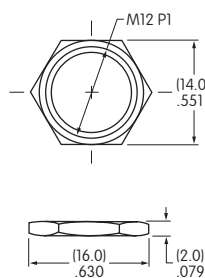

**AT401P  
O-ring for Splashproof  
Models**  
Nitrile butadiene rubber

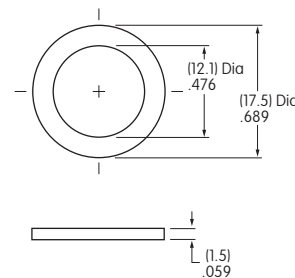

## OPTIONAL SPLASHPROOF BOOTS

Various optional nuts and ON-OFF plates are available; dimensions are shown in the Accessories & Hardware section.

**AT428 (M-metric H-Inch)  
.445" (11.3mm)  
Boot for S Toggle**  
Silicon Rubber

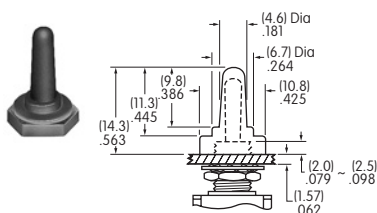

**AT402  
.760" (19.3mm)  
Boot for B2 Toggle**  
Silicon Rubber

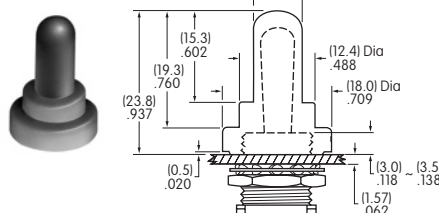

**AT402S  
.567" (14.4mm)  
Boot for B Toggle**  
Silicon Rubber

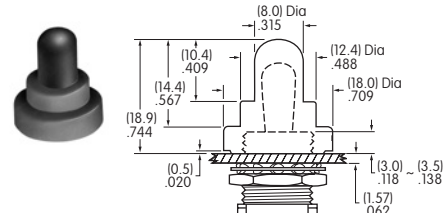

**AT401A/H/S  
.461" (11.7mm)  
Boot, Nut and O-ring for B2 Toggle**  
More details in Accessories section

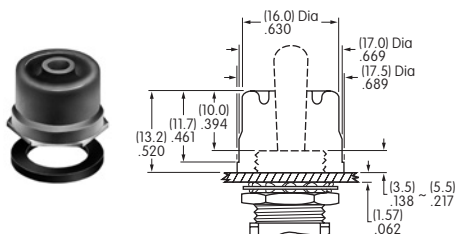

**AT4181** ← NEW  
**.732" (18.6mm)**  
Boot, Nut and O-ring for B2 Toggle  
More details in Accessories section

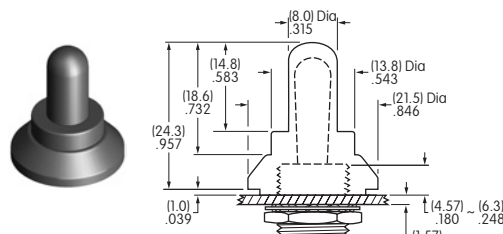

A	Toggles
	Rockers
	Pushbuttons
	Illuminated PB
	Programmable
	Keylocks
	Rotaries
	Slides
	Tactiles
	Tilt
	Touch
	Indicators
	Accessories
	Supplement



Компания «ЭлектроПласт» предлагает заключение долгосрочных отношений при поставках импортных электронных компонентов на взаимовыгодных условиях!

Наши преимущества:

- Оперативные поставки широкого спектра электронных компонентов отечественного и импортного производства напрямую от производителей и с крупнейших мировых складов;
- Поставка более 17-ти миллионов наименований электронных компонентов;
- Поставка сложных, дефицитных, либо снятых с производства позиций;
- Оперативные сроки поставки под заказ (от 5 рабочих дней);
- Экспресс доставка в любую точку России;
- Техническая поддержка проекта, помощь в подборе аналогов, поставка прототипов;
- Система менеджмента качества сертифицирована по Международному стандарту ISO 9001;
- Лицензия ФСБ на осуществление работ с использованием сведений, составляющих государственную тайну;
- Поставка специализированных компонентов (Xilinx, Altera, Analog Devices, Intersil, Interpoint, Microsemi, Aeroflex, Peregrine, Syfer, Eurofarad, Texas Instrument, Miteq, Cobham, E2V, MA-COM, Hittite, Mini-Circuits, General Dynamics и др.);

Помимо этого, одним из направлений компании «ЭлектроПласт» является направление «Источники питания». Мы предлагаем Вам помощь Конструкторского отдела:

- Подбор оптимального решения, техническое обоснование при выборе компонента;
- Подбор аналогов;
- Консультации по применению компонента;
- Поставка образцов и прототипов;
- Техническая поддержка проекта;
- Защита от снятия компонента с производства.



#### Как с нами связаться

**Телефон:** 8 (812) 309 58 32 (многоканальный)

**Факс:** 8 (812) 320-02-42

**Электронная почта:** [org@eplast1.ru](mailto:org@eplast1.ru)

**Адрес:** 198099, г. Санкт-Петербург, ул. Калинина, дом 2, корпус 4, литера А.