

General Specifications

Electrical Capacity (Resistive Load)

Power Level (silver): 6A @ 125V AC & 3A @ 250V AC

4A @ 30V DC for On-None-On & On-None-Off; 3A @ 30V DC for all other circuits

Logic Level (gold): 0.4VA maximum @ 28V AC/DC maximum (Applicable Range 0.1mA ~ 0.1A @ 20mV ~ 28V)

Logic/Power Level (gold over silver): Combines silver & gold ratings

Note: Find additional explanation of dual rating & operating range in Supplement section.

Other Ratings

Contact Resistance: 10 milliohms maximum for silver; 20 milliohms maximum for gold

Insulation Resistance: 1,000 megohms minimum @ 500V DC

Dielectric Strength: 1,000V AC minimum between contacts for 1 minute minimum;
1,500V AC minimum between contacts and case for 1 minute minimum

Mechanical Life: 100,000 operations minimum; 50,000 operations minimum for flat, locking & splashproof devices

Electrical Life: 25,000 operations minimum for silver; 50,000 operations minimum for gold;

50,000 operations minimum for silver at 3A @ 125V AC

Angle of Throw: 25°

Materials & Finishes

Toggle: Brass with chrome plating

Frame: Stainless steel

Bushing: Brass with nickel plating

Support Bracket: Brass with tin plating

Case: Diallyl phthalate resin (UL94V-0)

Movable Contactor: Phosphor bronze with silver or gold plating

Movable Contacts: Silver alloy (code W); copper with gold plating (code G); or silver alloy with gold plating (code A)

Stationary Contacts: Silver with silver plating (code W); copper or brass with gold plating (code G);
or silver with gold plating (code A)

Terminals: Copper or brass with silver plating; or copper or brass with gold plating

Environmental Data

Operating Temp Range: -30°C through +85°C (-22°F through +185°F)

Humidity: 90 ~ 95% humidity for 96 hours @ 40°C (104°F)

Vibration: 10 ~ 55Hz with peak-to-peak amplitude of 1.5mm traversing the frequency range & returning
in 1 minute; 3 right angled directions for 2 hours

Shock: 50G (490m/s²) acceleration (tested in 6 right angled directions, with 5 shocks in each direction)

Sealing: Splashproof bushing options B3, D3, D8, L3, & L8, which have o-rings inside & outside the
bushing, meet IP67 of IEC60529 Standards.

Installation

Mounting Torque: 3.0Nm (26.55 lb•in) double nut for large bushing;

1.5Nm (13 lb•in) double nut & 0.7Nm (6 lb•in) single nut for all other bushings

Processing

Soldering: Wave Soldering (PC version) for Gold: See Profile A in Supplement section.

Manual Soldering for Gold: See Profile A in Supplement section.

Wave Soldering (PC version) for Silver: See Profile B in Supplement section.

Manual Soldering for Silver: See Profile B in Supplement section.

Note: Lever must be in OFF (center) position while soldering.

Cleaning: These devices are not process sealed. Hand clean locally using alcohol based solution.

Standards & Certifications

Flammability Standards: UL94V-0 for case

UL: File No. E44145 - Recognized only when ordered with marking on switch.

Add "/U" or "/CUL" before dash in part number to order UL recognized switch.

All models recognized at 6A @ 125V AC, 3A @ 250V AC or 0.4VA maximum @ 28V DC maximum.

CSA: File No. 023535_0_000 - Certified only when ordered with marking on switch.

Add "/C" before dash in part number to order CSA certified switch.

All models certified at 6A @ 125V AC or 3A @ 250V AC or 0.4VA maximum @ 28V maximum.

Distinctive Characteristics

Antirotation design, standard on noncylindrical levers, mates toggle and bushing; bottom of toggle has two flattened sides which fit into a complementary opening inside bushing.

Antijamming design protects contacts from damage due to excessive downward force on actuator.

High torque bushing construction prevents rotation or separation from frame during installation.

High insulating barriers increase isolation of circuits in multipole devices and provide added protection to contact points.

Molded diallyl phthalate case has a UL flammability rating of 94V-0.

Epoxy sealed terminals prevent entry of solder flux and other contaminants.

Prominent external insulating barriers increase insulation resistance and dielectric strength.

Interlocked actuator block, lever, and interior guide prevent switch failure due to biased lever movement.

Clinching of frame to case well above base and terminals provides 1,500V dielectric strength.

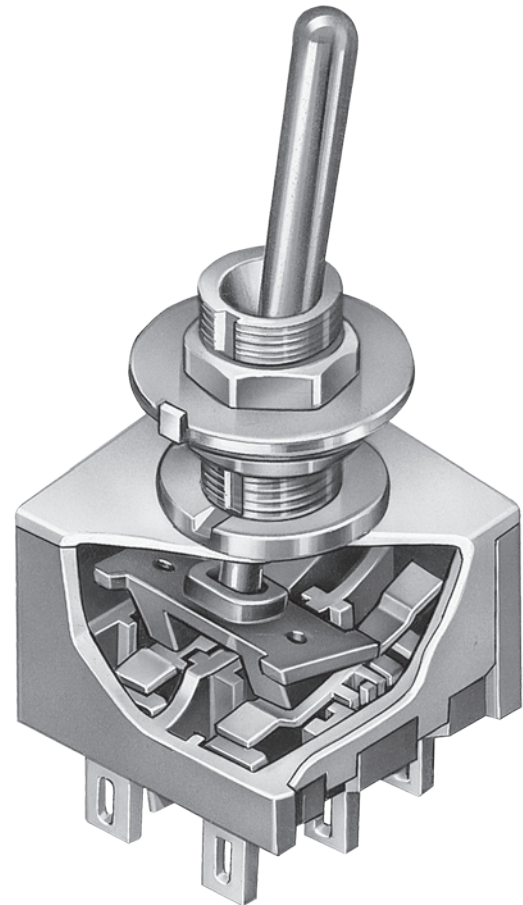

Actual Size



	Bushing Mount	Page A48
	Bracket PC Mount	Page A60
	Angle PC Mount	Page A66

A Toggles

Rockers

Pushbuttons

Illuminated PB

Programmable

Keylocks

Rotaries

Slides

Tactiles

Tilt

Touch

Indicators

Accessories

Supplement

M20

1

3

S

S1

Poles	
1	SPST SPDT
2	DPST DPDT SP3T
3	3PDT
4	4PDT DP3T

Small Toggles	
S	.413" (10.5mm) Bat
S2	.200" (5.08mm) Bat
S3	.256" (6.5mm) Bat
E	.450" (11.4mm) Flatted
* E2	.256" (6.5mm) Flatted
E4	.840" (21.3mm) Flatted
* Q	.550" (14.0mm) Cone
* Q2	.640" (16.26mm) Cone
* Q4	.840" (21.3mm) Cone
* C	.571" (14.5mm) Color Tipped Cone
D	.840" (21.3mm) Color Capped Cone

Specify cap color for toggles C & D at the end of the part number.
* Available on 1- and 2-pole only.

Small Bushings	
S1	.350" (8.9mm) Threaded with Keyway
S4	6mm .350" (8.9mm) Threaded with Keyway
S2	.350" (8.9mm) Smooth with Keyway
A1	.280" (7.1mm) Threaded with Keyway
A2	.280" (7.1mm) Smooth with Keyway
D1	.350" (8.9mm) Threaded with D Flat
D4	6mm .350" (8.9mm) Threaded with D Flat
D3	.350" (8.9mm) Threaded Splashproof with D Flat (combines only with S, S2 & S3)
D8	6mm .350" (8.9mm) Threaded Splashproof with D Flat (combines only with S, S2 & S3)

Circuits			
* 1	ON	NONE	OFF
2	ON	NONE	ON
3	ON	OFF	ON
5	ON	NONE	(ON)
8	(ON)	OFF	(ON)
9	ON	OFF	(ON)
**4	ON	ON	ON
**6	(ON)	ON	(ON)
**7	ON	ON	(ON)

() = Momentary

* ON-NONE-OFF circuit available in 1- and 2-pole only.

** 3-ON circuits

Large Toggles	
B	.453" (11.5mm) Large Bat
B2	.689" (17.5mm) Large Bat
R	.610" (15.5mm) Large Flatted

Large Bushings	
B1	Large .472" (12mm) Threaded with Keyway
B3	Large .472" (12mm) Threaded Splashproof with D Flat

Locking Lever	
L	.201" (5.1mm) Dia. Locking Lever

Bushings For Locking Levers	
L1	.291" (7.4mm) Threaded with Keyway for Lever Lock
L4	6mm .291" (7.4mm) Threaded with Keyway for Lever Lock
L2	Smooth with Keyway for Lever Lock
L3	.295" (7.5mm) Threaded Splashproof with D Flat for Lever Lock
L8	6mm .295" (7.5mm) Threaded Splashproof with D Flat for Lever Lock

IMPORTANT:



Switches are supplied without UL, cULus & CSA marking unless specified.
UL, cULus & CSA recognized only when ordered with marking on the switch.
Specific models, ratings, & ordering instructions are noted on General Specifications page.

ORDERING EXAMPLE

<div style="border: 1px solid black; padding: 5px; width: 40px; margin: 0 auto;">W</div>	<div style="border: 1px solid black; padding: 5px; width: 40px; margin: 0 auto;">01</div>	<div style="border: 1px solid black; width: 40px; height: 20px; margin: 0 auto;"></div>	<div style="border: 1px solid black; width: 40px; height: 20px; margin: 0 auto;"></div>																										
<table border="1" style="width: 100%; border-collapse: collapse;"> <thead> <tr> <th colspan="2">Contact Materials & Ratings</th> </tr> </thead> <tbody> <tr> <td style="width: 10%; text-align: center;">W</td> <td>Silver; Rated 6A @ 125V AC & 3A @ 250V AC</td> </tr> <tr> <td style="text-align: center;">G</td> <td>Gold; Rated 0.4VA max @ 28V AC/DC max</td> </tr> <tr> <td style="text-align: center;">A</td> <td>Gold over Silver; Rated 6A @ 125V AC & 0.4VA max @ 28V AC/DC max</td> </tr> </tbody> </table>		Contact Materials & Ratings		W	Silver; Rated 6A @ 125V AC & 3A @ 250V AC	G	Gold; Rated 0.4VA max @ 28V AC/DC max	A	Gold over Silver; Rated 6A @ 125V AC & 0.4VA max @ 28V AC/DC max	<table border="1" style="width: 100%; border-collapse: collapse;"> <thead> <tr> <th colspan="2">Optional Caps</th> </tr> </thead> <tbody> <tr> <td colspan="2" style="text-align: center;">For Small Bat Toggles</td> </tr> <tr> <td style="width: 10%; text-align: center;">B</td> <td>For S Bat Toggle</td> </tr> <tr> <td style="text-align: center;">C</td> <td>Conical Cap for S Bat Toggle</td> </tr> <tr> <td colspan="2" style="text-align: center;">For Large Bat Toggles</td> </tr> <tr> <td style="text-align: center;">R</td> <td>For B Toggle</td> </tr> <tr> <td style="text-align: center;">V</td> <td>For B2 Toggle</td> </tr> </tbody> </table>		Optional Caps		For Small Bat Toggles		B	For S Bat Toggle	C	Conical Cap for S Bat Toggle	For Large Bat Toggles		R	For B Toggle	V	For B2 Toggle				
Contact Materials & Ratings																													
W	Silver; Rated 6A @ 125V AC & 3A @ 250V AC																												
G	Gold; Rated 0.4VA max @ 28V AC/DC max																												
A	Gold over Silver; Rated 6A @ 125V AC & 0.4VA max @ 28V AC/DC max																												
Optional Caps																													
For Small Bat Toggles																													
B	For S Bat Toggle																												
C	Conical Cap for S Bat Toggle																												
For Large Bat Toggles																													
R	For B Toggle																												
V	For B2 Toggle																												
<table border="1" style="width: 100%; border-collapse: collapse;"> <thead> <tr> <th colspan="2">Terminals</th> </tr> </thead> <tbody> <tr> <td style="width: 10%; text-align: center;">01</td> <td>Solder Lug*</td> </tr> <tr> <td style="text-align: center;">02</td> <td>Quick Connect</td> </tr> <tr> <td style="text-align: center;">03</td> <td>.250" (6.35mm) Straight PC</td> </tr> <tr> <td style="text-align: center;">05</td> <td>.425" (10.8mm) Wirewrap</td> </tr> <tr> <td style="text-align: center;">06</td> <td>.750" (19.05mm) Wirewrap</td> </tr> <tr> <td style="text-align: center;">07</td> <td>.964" (24.5mm) Wirewrap</td> </tr> <tr> <td style="text-align: center;">08</td> <td>1.062" (27.0mm) Wirewrap</td> </tr> </tbody> </table>		Terminals		01	Solder Lug*	02	Quick Connect	03	.250" (6.35mm) Straight PC	05	.425" (10.8mm) Wirewrap	06	.750" (19.05mm) Wirewrap	07	.964" (24.5mm) Wirewrap	08	1.062" (27.0mm) Wirewrap	<table border="1" style="width: 100%; border-collapse: collapse;"> <thead> <tr> <th colspan="2">Cap for Locking Lever</th> </tr> </thead> <tbody> <tr> <td style="width: 10%; text-align: center;">No Code</td> <td>Nickel Plated Supplied with Switch</td> </tr> <tr> <td style="text-align: center;">A</td> <td>Black</td> </tr> <tr> <td style="text-align: center;">C</td> <td>Red</td> </tr> <tr> <td style="text-align: center;">G</td> <td>Blue</td> </tr> </tbody> </table>		Cap for Locking Lever		No Code	Nickel Plated Supplied with Switch	A	Black	C	Red	G	Blue
Terminals																													
01	Solder Lug*																												
02	Quick Connect																												
03	.250" (6.35mm) Straight PC																												
05	.425" (10.8mm) Wirewrap																												
06	.750" (19.05mm) Wirewrap																												
07	.964" (24.5mm) Wirewrap																												
08	1.062" (27.0mm) Wirewrap																												
Cap for Locking Lever																													
No Code	Nickel Plated Supplied with Switch																												
A	Black																												
C	Red																												
G	Blue																												
		<table border="1" style="width: 100%; border-collapse: collapse;"> <thead> <tr> <th colspan="2">Cap Colors</th> </tr> </thead> <tbody> <tr> <td style="width: 10%; text-align: center;">A</td> <td>Black</td> </tr> <tr> <td style="text-align: center;">B</td> <td>White</td> </tr> <tr> <td style="text-align: center;">C</td> <td>Red</td> </tr> <tr> <td style="text-align: center;">E</td> <td>Yellow</td> </tr> <tr> <td style="text-align: center;">F</td> <td>Green</td> </tr> <tr> <td style="text-align: center;">G</td> <td>Blue</td> </tr> <tr> <td style="text-align: center;">H</td> <td>Gray (for K1 & K2 paddles)</td> </tr> </tbody> </table>		Cap Colors		A	Black	B	White	C	Red	E	Yellow	F	Green	G	Blue	H	Gray (for K1 & K2 paddles)										
Cap Colors																													
A	Black																												
B	White																												
C	Red																												
E	Yellow																												
F	Green																												
G	Blue																												
H	Gray (for K1 & K2 paddles)																												

* Wire harness & cable assemblies offered only in Americas

DESCRIPTION FOR TYPICAL ORDERING EXAMPLE

M2013SS1W01



POLES & CIRCUITS

Pole	Model	Toggle Position () = Momentary			Connected Terminals			Throw & Schematics
		Down 	Center 	Up 	Down 	Center 	Up 	
SP	M2011	ON	NONE	OFF	2-3	OPEN	OPEN	SPST 
SP	M2012 M2013 M2015 M2018 M2019	ON ON ON (ON) ON	NONE OFF NONE OFF OFF	ON ON (ON) (ON) (ON)	2-3	OPEN	2-1	SPDT 
DP	M2021	ON	NONE	OFF	2-3 5-6	OPEN	OPEN	DPST 
DP	M2022 M2023 M2025 M2028 M2029	ON ON ON (ON) ON	NONE OFF NONE OFF OFF	ON ON (ON) (ON) (ON)	2-3 5-6	OPEN	2-1 5-4	DPDT 
3P	M2032 M2033 M2035 M2038 M2039	ON ON ON (ON) ON	NONE OFF NONE OFF OFF	ON ON (ON) (ON) (ON)	2-3 5-6 8-9	OPEN	2-1 5-4 8-7	3PDT 
4P	M2042 M2043 M2045 M2048 M2049	ON ON ON (ON) ON	NONE OFF NONE OFF OFF	ON ON (ON) (ON) (ON)	2-3 5-6 8-9 11-12	OPEN	2-1 5-4 8-7 11-10	4PDT 

For 3 Throw (3-On)

Connected Terminals & Schematic

Pole	Model	Down	Center	Up	Down	Center	Up
SP	M2024 M2026 M2027	ON (ON) ON	ON ON ON	ON (ON) (ON)	 2-3 5-6	 2-3 5-4	 2-1 5-4
DP	M2044 M2046 M2047	ON (ON) ON	ON ON ON	ON (ON) (ON)	 2-3 5-6 8-9 11-12	 2-3 5-4 8-9 11-10	 2-1 5-4 8-7 11-10

The SP3T model utilizes a double pole base.

External connection must be made during field installation.



The DP3T model utilizes a four pole base.

External connection must be made during field installation.



SMALL TOGGLES

S .413" (10.5mm)
Bat

S2 .200" (5.08mm)
Bat

S3 .256" (6.5mm)
Bat

Important:

Toggle length changes based on bushing selected. All illustrations are shown with .350" long bushing. When using a .280" long bushing, toggle length increases .070".



Standard Material & Finish: Brass with Bright Chrome
Contact factory for optional finishes.

E .450" (11.4mm)
Flatted

E2 .256" (6.5mm)
Flatted

E4 .840" (21.3mm)
Flatted

C .571" (14.5mm)
Color Tipped Cone
Supplied with Cap AT445

Material: Polycarbonate

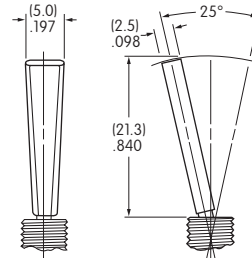

Only Available in 1- & 2-Pole

Only Available in 1- & 2-Pole

Q .550" (14.0mm)
Cone

Q2 .640" (16.26mm)
Cone

Q4 .840" (21.3mm)
Cone

D .840" (21.3mm)
Color Capped Cone
Supplied with Cap AT460

Material: Polyethylene



Only Available in 1- & 2-Pole

Only Available in 1- & 2-Pole

Only Available in 1- & 2-Pole

Cap Colors Available:

A

Black

B

White

C

Red

E

Yellow

F

Green

G

Blue

H

Gray
(For K1 & K2 only)

SMALL BUSHINGS

S1 1/4-40 .350" (8.9mm)
Threaded with Keyway



Maximum Panel Thickness with Standard Hardware: .102" (2.6mm)

S4 6mm/.350" (8.9mm)
Threaded with Keyway



Maximum Panel Thickness with Standard Hardware: .102" (2.6mm)

S2 .350" (8.9mm)
Smooth with Keyway



A1 1/4-40 .280" (7.1mm)
Threaded with Keyway



When using this bushing, toggle length is increased by .070". Maximum Panel Thickness with Standard Hardware: .031" (0.8mm)

A2 .280" (7.1mm)
Smooth with Keyway



When using this bushing, toggle length is increased by .070".

D1 1/4-40 .350" (8.9mm)
Threaded with D Flat



Maximum Panel Thickness with Standard Hardware: .102" (2.6mm)

D4 6mm/.350" (8.9mm)
Threaded with D Flat



Maximum Panel Thickness with Standard Hardware: .102" (2.6mm)

D3 1/4-40 .350" (8.9mm)
Threaded Splashproof with D Flat



D3 combines only with S, S2 & S3 toggles. Maximum Panel Thickness with Standard Hardware: .193" (4.9mm)

D8 6mm/.350" (8.9mm)
Threaded Splashproof with D Flat



D8 combines only with S, S2 & S3 toggles. Maximum Panel Thickness with Standard Hardware: .193" (4.9mm)

Standard Hardware Supplied for Small Bushings

Bushing Codes	S1/S4	A1	D1/D4	D3/D8	L1/L4	L3/L8
Hex Nut	2	2	2	1	2	1
Locking Ring	1	1	0	0	1	0
Lockwasher	1	1	1	0	1	0
O-ring	0	0	0	1	0	1

For S1, S2, A1, A2 or S4 Bushing with Keyway & for L1 or L4 Bushing



For S1, A1 or S4 Bushing with Locking Ring & for L1 or L4 Bushing



For D1, D4, D3 or D8 Bushing with D Flat & for L3 or L8 Bushing



LARGE TOGGLES

Toggle & Bushing Combinations: These toggles combine with the 12mm bushings B1 & B3.

B .453" (11.5mm)
Large Bat



B2 .689" (17.5mm)
Large Bat



R .610" (15.5mm)
Large Flatted

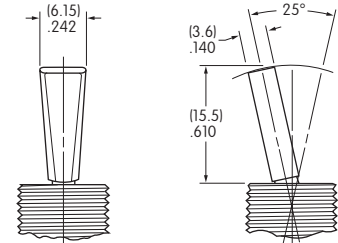

Standard Material & Finish: Brass with Bright Chrome
Optional Finishes: Contact factory for satin chrome or black.

LARGE BUSHINGS

B1 Large .472" (12.0mm)
Threaded with Keyway



Maximum Panel Thickness with
Standard Hardware: .216" (5.5mm)

Standard Hardware for B1:
1 hex face nut AT503M, 1 locking ring AT506M,
1 lockwasher AT508, and 1 hex backup nut AT527M

B3 Large .472" (12.0mm)
Threaded Splashproof with D Flat



Maximum Panel Thickness with
Standard Hardware: .256" (6.5mm)

Standard Hardware for B3:
1 hex face nut AT503M
and 1 o-ring AT401P

Panel Cutouts

**For B1 Bushing
with Keyway**



**For B1 Bushing
with Locking Ring**



**For B3 Bushing
with D Flat**



LOCKING LEVER & BUSHINGS

LL1 1/4-40 .291" (7.4mm)
Threaded with Keyway



LL4 6mm/.291" (7.4mm)
Threaded with Keyway



LL2 Smooth with Keyway



Maximum Panel Thickness with Standard Hardware: .047" (1.2mm)
Standard Hardware for L1 & L4: 2 hex nuts AT513H or AT513M,
1 locking ring AT507H or AT507M, and 1 lockwasher AT509

LL3 1/4-40 .295" (7.5mm)
Threaded Splashproof with D Flat



LL8 6mm/.295" (7.5mm)
Threaded Splashproof with D Flat



Maximum Panel Thickness with Standard Hardware: .047" (1.2mm)
Standard Hardware for L3 and L8: 1 hex nut AT513H or AT513M and 1 o-ring AT516

Lever Material & Finish: Brass with Chrome Plating

Locking Mechanism

on-none-on



2 positions lock

on-none-(on)



1 position locks

on-off-(on)
on-on-(on)



2 positions lock

on-off-on
on-on-on

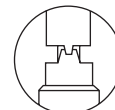

3 positions lock

(on)-off-(on)
(on)-on-(on)



1 position locks

No Code

Supplied with Cap AT427



Lever

Color Codes for Optional Anodized Aluminum Caps

Cap Material:
Brass with Nickel Plating



Black



Red



Blue

CONTACT MATERIALS & RATINGS

W

Silver over Silver

Power Level

6A @ 125V AC & 3A @ 250V AC

G

Gold over Brass or Copper

Logic Level

6A @ 125V AC & 3A @ 250V AC

Note: See Supplement section to find complete explanation of operating range.

A

Gold over Silver

Power Level
or Logic Level

6A @ 125V AC
or 0.4VA maximum @ 28V AC/DC maximum

Note: This dual rated option is suitable when two or more identical switches are used in logic and in power circuits within the same application. See Supplement section to find complete explanation of dual rating and operating range.

TERMINALS

01

Solder Lug



02

.062" (1.57mm) Wide Quick Connect

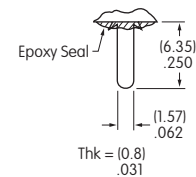

03

.250" (6.35mm) Straight PC



Single Pole



Double Pole



Three Pole



Four Pole

05

.425" (10.8mm) Wirewrap or Extended PC

07

.964" (24.5mm) Wirewrap or Extended PC

06

.750" (19.05mm) Wirewrap or Extended PC

08

1.062" (27.0mm) Wirewrap or Extended PC

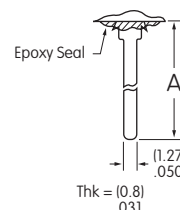

Dimension A = terminal lengths as shown beside the terminal codes at the left.

If using as extended PC terminal, refer to the above footprints.

OPTIONAL CAPS & CAP COLORS

B

AT415 Lever Cap for S Bat Toggle

Material: Polyethylene



C

AT444 Conical Cap for S Bat Toggle

Material: Polyethylene



R

AT434 Lever Cap for B Toggle

Material: Polyvinyl Chloride



V

AT406 Lever Cap for B2 Toggle

Material: Polyvinyl Chloride



Cap Colors Available:

A

Black

B

White

C

Red

E

Yellow

F

Green

G

Blue

TYPICAL SWITCH DIMENSIONS

Solder Lug

Single Pole



M2012SS1W01

M2011 model does not have terminal 1.

Solder Lug

Double Pole



M2022SS1W01

M2021 model does not have terminals 1 & 4.

Solder Lug

Three Pole



M2032SS1W01

Solder Lug

Four Pole

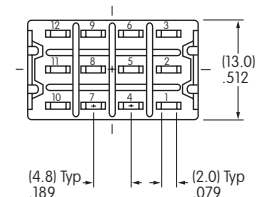

M2042SS1W01

Rockers

Pushbuttons

Illuminated PB

Programmable

Keylocks

Rotaries

Slides

Tactiles

Tilt

Touch

Indicators

Accessories

Supplement

STANDARD HARDWARE FOR SMALL & LARGE BUSHINGS

AT513H for Inch
AT513M for Metric
Hex Nut
Brass/Nickel

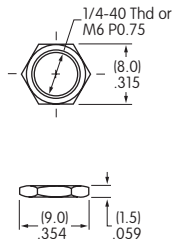

AT507H for Inch
AT507M for Metric
Locking Ring
Steel with Zinc/Chrome

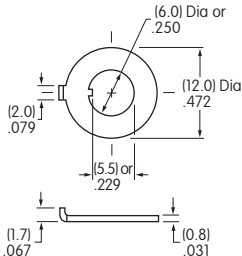

AT509
Lockwasher
Steel with Zinc/Chrome
(not supplied with splashproof models)

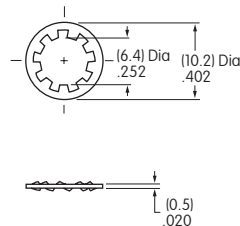

AT516
O-ring for Splashproof Models
Nitrile Butadiene Rubber



AT503M
Hex Face Nut
Brass/Chrome



AT506M
Locking Ring
Steel with Zinc/Chrome

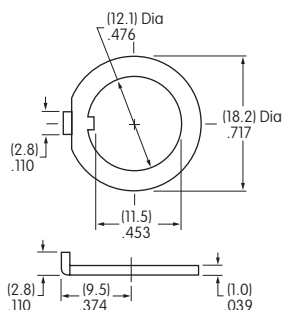

AT508
Lockwasher
Steel with Zinc/Chrome
(not supplied with splashproof models)

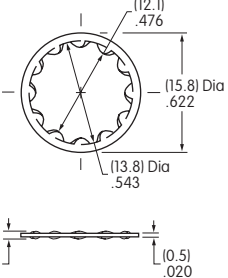

AT527M
Hex Nut
Steel with Nickel Plating



AT401P
O-ring for Splashproof Models
Nitrile butadiene rubber

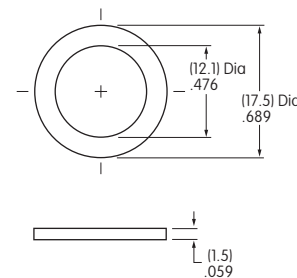

OPTIONAL SPLASHPROOF BOOTS

Various optional nuts and ON-OFF plates are available; dimensions are shown in the Accessories & Hardware section.

AT428 (M-metric H-Inch)
.445" (11.3mm)
Boot for S Toggle
Silicon Rubber

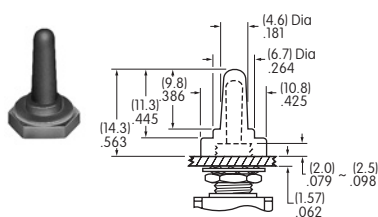

AT402
.760" (19.3mm)
Boot for B2 Toggle
Silicon Rubber

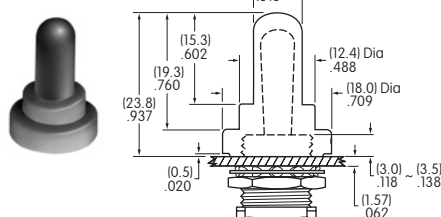

AT402S
.567" (14.4mm)
Boot for B Toggle
Silicon Rubber

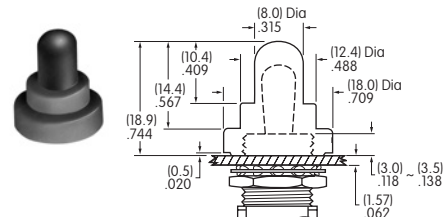

AT401A/H/S
.461" (11.7mm)
Boot, Nut and O-ring for B2 Toggle
More details in Accessories section

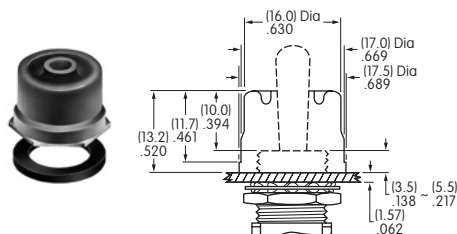

AT4181 ← NEW
.732" (18.6mm)
Boot, Nut and O-ring for B2 Toggle
More details in Accessories section

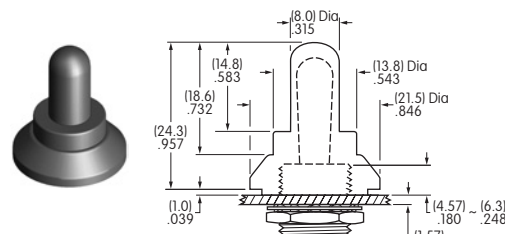

A	Toggles
	Rockers
	Pushbuttons
	Illuminated PB
	Programmable
	Keylocks
	Rotaries
	Slides
	Tactiles
	Tilt
	Touch
	Indicators
	Accessories
	Supplement



Компания «ЭлектроПласт» предлагает заключение долгосрочных отношений при поставках импортных электронных компонентов на взаимовыгодных условиях!

Наши преимущества:

- Оперативные поставки широкого спектра электронных компонентов отечественного и импортного производства напрямую от производителей и с крупнейших мировых складов;
- Поставка более 17-ти миллионов наименований электронных компонентов;
- Поставка сложных, дефицитных, либо снятых с производства позиций;
- Оперативные сроки поставки под заказ (от 5 рабочих дней);
- Экспресс доставка в любую точку России;
- Техническая поддержка проекта, помощь в подборе аналогов, поставка прототипов;
- Система менеджмента качества сертифицирована по Международному стандарту ISO 9001;
- Лицензия ФСБ на осуществление работ с использованием сведений, составляющих государственную тайну;
- Поставка специализированных компонентов (Xilinx, Altera, Analog Devices, Intersil, Interpoint, Microsemi, Aeroflex, Peregrine, Syfer, Eurofarad, Texas Instrument, Miteq, Cobham, E2V, MA-COM, Hittite, Mini-Circuits, General Dynamics и др.);

Помимо этого, одним из направлений компании «ЭлектроПласт» является направление «Источники питания». Мы предлагаем Вам помощь Конструкторского отдела:

- Подбор оптимального решения, техническое обоснование при выборе компонента;
- Подбор аналогов;
- Консультации по применению компонента;
- Поставка образцов и прототипов;
- Техническая поддержка проекта;
- Защита от снятия компонента с производства.



Как с нами связаться

Телефон: 8 (812) 309 58 32 (многоканальный)

Факс: 8 (812) 320-02-42

Электронная почта: org@eplast1.ru

Адрес: 198099, г. Санкт-Петербург, ул. Калинина, дом 2, корпус 4, литера А.