



3.3V 128K X 8 CMOS SRAM (Center power and ground)

Features

- Industrial and commercial temperatures
- Organization: 131,072 x 8 bits
- High speed
 - 10/12/15/20 ns address access time
 - 5, 6, 7, 8 ns output enable access time
- Low power consumption: ACTIVE
 - 252 mW / max @ 10 ns
- Low power consumption: STANDBY
 - 18 mW / max CMOS
- 6 T 0.18 u CMOS technology
- Easy memory expansion with \overline{CE} , \overline{OE} inputs
- Center power and ground
- TTL/LVTTL-compatible, three-state I/O
- JEDEC-standard packages
 - 32-pin, 300 mil SOJ
 - 32-pin, 400 mil SOJ
- ESD protection ≥ 2000 volts
- Latch-up current ≥ 200 mA

Pin arrangement

Logic block diagram

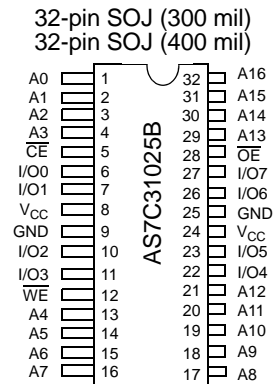
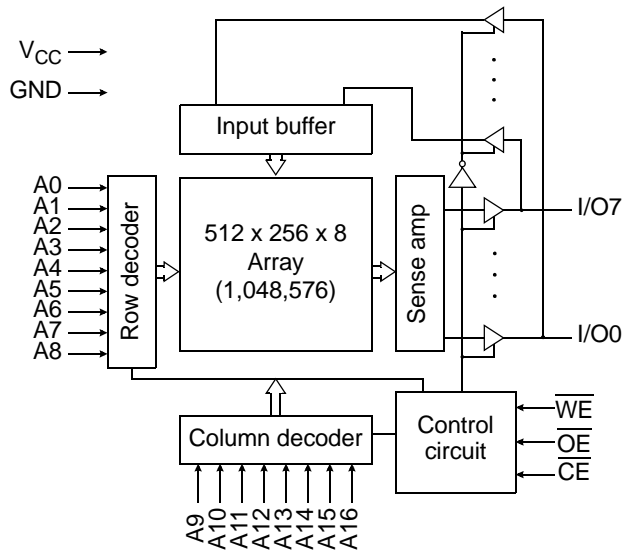

Selection guide

	-10	-12	-15	-20	Unit
Maximum address access time	10	12	15	20	ns
Maximum output enable access time	5	6	7	8	ns
Maximum operating current	70	65	60	55	mA
Maximum CMOS standby current	5	5	5	5	mA



Functional description

The AS7C31025B is a high-performance CMOS 1,048,576-bit Static Random Access Memory (SRAM) device organized as 131,072 x 8 bits. It is designed for memory applications where fast data access, low power, and simple interfacing are desired.

Equal address access and cycle times (t_{AA} , t_{RC} , t_{WC}) of 10/12/15/20 ns with output enable access times (t_{OE}) of 5, 6, 7, 8 ns are ideal for high-performance applications. The chip enable input \overline{CE} permits easy memory and expansion with multiple-bank memory systems.

When \overline{CE} is high the device enters standby mode. A write cycle is accomplished by asserting write enable (\overline{WE}) and chip enable (\overline{CE}). Data on the input pins I/O0 through I/O7 is written on the rising edge of \overline{WE} (write cycle 1) or \overline{CE} (write cycle 2). To avoid bus contention, external devices should drive I/O pins only after outputs have been disabled with output enable (\overline{OE}) or write enable (\overline{WE}).

A read cycle is accomplished by asserting output enable (\overline{OE}) and chip enable (\overline{CE}), with write enable (\overline{WE}) high. The chip drives I/O pins with the data word referenced by the input address. When either chip enable or output enable is inactive or write enable is active, output drivers stay in high-impedance mode.

All chip inputs and outputs are TTL-compatible, and operation is from a single 3.3 V supply. The AS7C31025B is packaged in common industry standard packages.

Absolute maximum ratings

Parameter	Symbol	Min	Max	Unit
Voltage on V_{CC} relative to GND	V_{t1}	-0.50	+5.0	V
Voltage on any pin relative to GND	V_{t2}	-0.50	$V_{CC} + 0.5$	V
Power dissipation	P_D	-	1.0	W
Storage temperature (plastic)	T_{stg}	-65	+150	°C
Ambient temperature with V_{CC} applied	T_{bias}	-55	+125	°C
DC current into outputs (low)	I_{OUT}	-	20	mA

NOTE: Stresses greater than those listed under *Absolute Maximum Ratings* may cause permanent damage to the device. This is a stress rating only and functional operation of the device at these or any other conditions outside those indicated in the operational sections of this specification is not implied. Exposure to absolute maximum rating conditions for extended periods may affect reliability.

Truth table

\overline{CE}	\overline{WE}	\overline{OE}	Data	Mode
H	X	X	High Z	Standby (I_{SB} , I_{SB1})
L	H	H	High Z	Output disable (I_{CC})
L	H	L	D_{OUT}	Read (I_{CC})
L	L	X	D_{IN}	Write (I_{CC})

Key: X = don't care, L = low, H = high.



Recommended operating conditions

Parameter	Symbol	Min	Nominal	Max	Unit
Supply voltage	V_{CC}	3.0	3.3	3.6	V
Input voltage	V_{IH}	2.0	–	$V_{CC} + 0.5$	V
	V_{IL}	–0.5	–	0.8	V
Ambient operating temperature	T_A	0	–	70	$^{\circ}\text{C}$
	T_A	–40	–	85	$^{\circ}\text{C}$

$V_{IL} = -1.0\text{V}$ for pulse width less than 5ns

$V_{IH} = V_{CC} + 1.5\text{V}$ for pulse width less than 5ns

DC operating characteristics (over the operating range)¹

Parameter	Sym	Test conditions	-10		-12		-15		-20		Unit
			Min	Max	Min	Max	Min	Max	Min	Max	
Input leakage current	$ I_{LI} $	$V_{CC} = \text{Max}, V_{IN} = \text{GND to } V_{CC}$	–	1	–	1	–	1	–	1	μA
Output leakage current	$ I_{LO} $	$V_{CC} = \text{Max}, \overline{\text{CE}} = V_{IH}, V_{out} = \text{GND to } V_{CC}$	–	1	–	1	–	1	–	1	μA
Operating power supply current	I_{CC}	$V_{CC} = \text{Max}$ $\overline{\text{CE}} \leq V_{IL}, f = f_{\text{Max}}, I_{OUT} = 0 \text{ mA}$	–	70	–	65	–	60	–	55	mA
Standby power supply current ¹	I_{SB}	$V_{CC} = \text{Max}$ $\overline{\text{CE}} \geq V_{IH}, f = f_{\text{Max}}$	–	30	–	25	–	20	–	20	mA
	I_{SB1}	$V_{CC} = \text{Max}, \overline{\text{CE}} \geq V_{CC} - 0.2 \text{ V}, V_{IN} \leq 0.2 \text{ V or } V_{IN} \geq V_{CC} - 0.2 \text{ V}, f = 0$	–	5	–	5	–	5	–	5	mA
Output voltage	V_{OL}	$I_{OL} = 8 \text{ mA}, V_{CC} = \text{Min}$	–	0.4	–	0.4	–	0.4	–	0.4	V
	V_{OH}	$I_{OH} = -4 \text{ mA}, V_{CC} = \text{Min}$	2.4	–	2.4	–	2.4	–	2.4	–	V

Capacitance ($f = 1 \text{ MHz}, T_a = 25^{\circ}\text{C}, V_{CC} = \text{NOMINAL}$)²



Parameter	Symbol	Signals	Test conditions	Max	Unit
Input capacitance	C_{IN}	A, $\overline{\text{CE}}, \overline{\text{WE}}, \overline{\text{OE}}$	$V_{IN} = 0 \text{ V}$	5	pF
I/O capacitance	$C_{I/O}$	I/O	$V_{IN} = V_{OUT} = 0 \text{ V}$	7	pF



Read cycle (over the operating range)^{3,9}

Parameter	Symbol	-10		-12		-15		-20		Unit	Notes
		Min	Max	Min	Max	Min	Max	Min	Max		
Read cycle time	t_{RC}	10	–	12	–	15	–	20	–	ns	
Address access time	t_{AA}	–	10	–	12	–	15	–	20	ns	3
Chip enable (\overline{CE}) access time	t_{ACE}	–	10	–	12	–	15	–	20	ns	3
Output enable (\overline{OE}) access time	t_{OE}	–	5	–	6	–	7	–	8	ns	
Output hold from address change	t_{OH}	3	–	3	–	3	–	3	–	ns	5
\overline{CE} low to output in low Z	t_{CLZ}	3	–	3	–	3	–	3	–	ns	4, 5
\overline{CE} high to output in high Z	t_{CHZ}	–	3	–	3	–	4	–	5	ns	4, 5
\overline{OE} low to output in low Z	t_{OLZ}	0	–	0	–	0	–	0	–	ns	4, 5
\overline{OE} high to output in high Z	t_{OHZ}	–	5	–	6	–	7	–	8	ns	4, 5
Power up time	t_{PU}	0	–	0	–	0	–	0	–	ns	4, 5
Power down time	t_{PD}	–	10	–	12	–	15	–	20	ns	4, 5

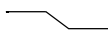
Key to switching waveforms

 Rising input
  Falling input
  Undefined/don't care

Read waveform 1 (address controlled)^{3,6,7,9}

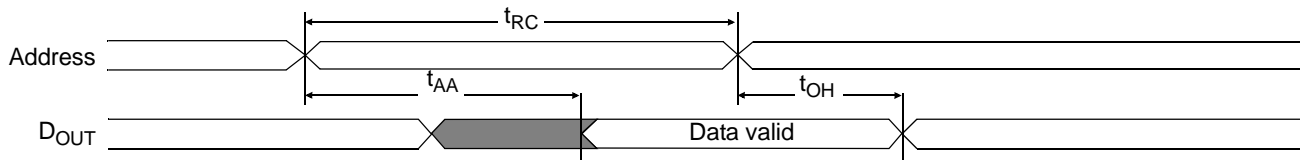

Read waveform 2 (\overline{CE} and \overline{OE} controlled)^{3,6,8,9}





Write cycle (over the operating range)¹¹

Parameter	Symbol	-10		-12		-15		-20		Unit	Notes
		Min	Max	Min	Max	Min	Max	Min	Max		
Write cycle time	t_{WC}	10	–	12	–	15	–	20	–	ns	
Chip enable (\overline{CE}) to write end	t_{CW}	8	–	9	–	10	–	12	–	ns	
Address setup to write end	t_{AW}	8	–	9	–	10	–	12	–	ns	
Address setup time	t_{AS}	0	–	0	–	0	–	0	–	ns	
Write pulse width	t_{WP}	7	–	8	–	9	–	12	–	ns	
Write recovery time	t_{WR}	0	–	0	–	0	–	0	–	ns	
Address hold from end of write	t_{AH}	0	–	0	–	0	–	0	–	ns	
Data valid to write end	t_{DW}	5	–	6	–	8	–	10	–	ns	
Data hold time	t_{DH}	0	–	0	–	0	–	0	–	ns	4, 5
Write enable to output in high Z	t_{WZ}	–	5	–	6	–	7	–	8	ns	4, 5
Output active from write end	t_{OW}	1	–	1	–	1	–	1	–	ns	4, 5

Write waveform 1 (\overline{WE} controlled)^{10,11}

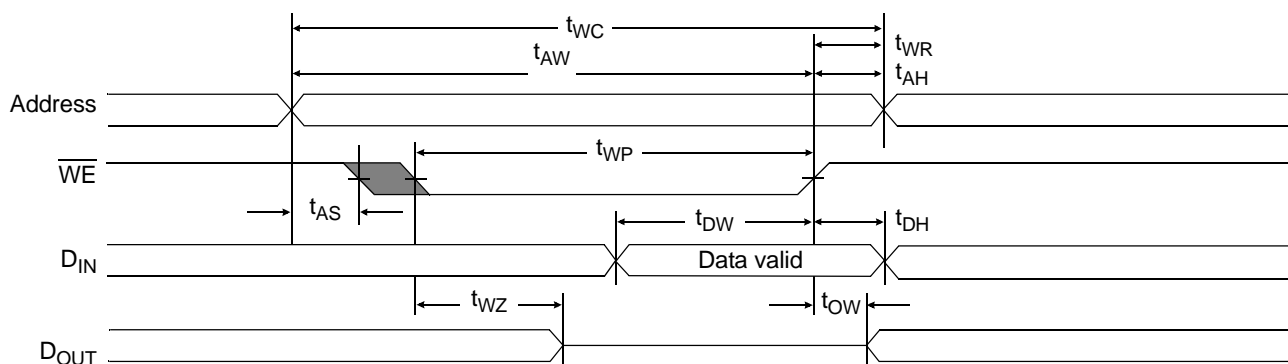

Write waveform 2 (\overline{CE} controlled)^{10,11}

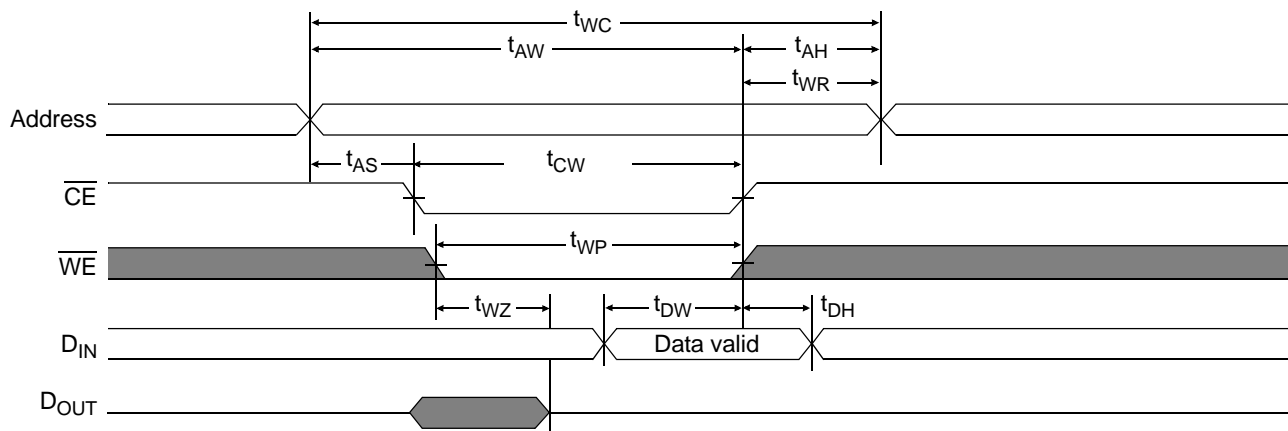



AC test conditions

- Output load: see Figure B.
- Input pulse level: GND to 3.0 V. See Figure A.
- Input rise and fall times: 2 ns. See Figure A.
- Input and output timing reference levels: 1.5 V.

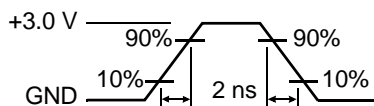

Figure A: Input pulse

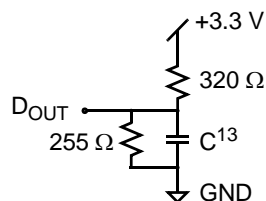

Figure B: 3.3 V Output load

Notes

- 1 During V_{CC} power-up, a pull-up resistor to V_{CC} on \overline{CE} is required to meet I_{SB} specification.
- 2 This parameter is sampled, but not 100% tested.
- 3 For test conditions, see *AC Test Conditions*, Figures A and B.
- 4 t_{CLZ} and t_{CHZ} are specified with $C_L = 5$ pF, as in Figure B. Transition is measured ± 500 mV from steady-state voltage.
- 5 This parameter is guaranteed, but not 100% tested.
- 6 \overline{WE} is high for read cycle.
- 7 \overline{CE} and \overline{OE} are low for read cycle.
- 8 Address is valid prior to or coincident with \overline{CE} transition low.
- 9 All read cycle timings are referenced from the last valid address to the first transitioning address.
- 10 N/A
- 11 All write cycle timings are referenced from the last valid address to the first transitioning address.
- 12 N/A.
- 13 $C = 30$ pF, except all high Z and low Z parameters where $C = 5$ pF.



Package dimensions

32-pin SOJ
300 mil/400 mil

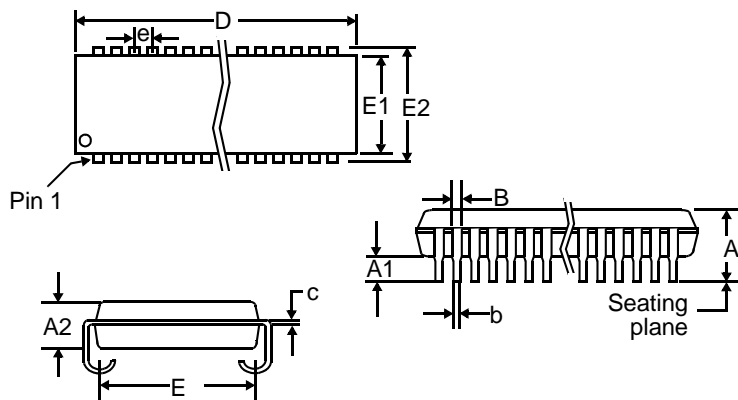

Symbol	32-pin SOJ 300 mil		32-pin SOJ 400 mil	
	Min	Max	Min	Max
A	0.128	0.145	0.132	0.146
A1	0.025	-	0.025	-
A2	0.095	0.105	0.105	0.115
B	0.026	0.032	0.026	0.032
b	0.016	0.020	0.015	0.020
c	0.007	0.010	0.007	0.013
D	0.820	0.830	0.820	0.830
E	0.255	0.275	0.354	0.378
E1	0.295	0.305	0.395	0.405
E2	0.330	0.340	0.435	0.445
e	0.050 BSC		0.050 BSC	



Ordering Codes

Package \ Access time	Temperature	10 ns	12 ns	15 ns	20 ns
300-mil SOJ	Commercial	AS7C31025B-10TJC	AS7C31025B-12TJC	AS7C31025B-15TJC	AS7C31025B-20TJC
	Industrial	AS7C31025B-10TJI	AS7C31025B-12TJI	AS7C31025B-15TJI	AS7C31025B-20TJI
400-mil SOJ	Commercial	AS7C31025B-10JC	AS7C31025B-12JC	AS7C31025B-15JC	AS7C31025B-20JC
	Industrial	AS7C31025B-10JI	AS7C31025B-12JI	AS7C31025B-15JI	AS7C31025B-0JI

Note:

Add suffix 'N' to the above part number for lead free parts (Ex. AS7C31025B-10TJCN)

Part numbering system

AS7C	X	1025B	-XX	X	X	X
SRAM prefix	Voltage: 3 = 3.3 V CMOS	Device number	Access time	Package: TJ = SOJ 300 mil J = SOJ 400 mil	Temperature range C = commercial, 0° C to 70° C I = industrial, -40° C to 85° C	N=Lead Free Part



Alliance Semiconductor Corporation

2575, Augustine Drive,

Santa Clara, CA 95054

Tel: 408 - 855 - 4900

Fax: 408 - 855 - 4999

www.alsc.com

Copyright © Alliance Semiconductor

All Rights Reserved

Part Number: AS7C31025B

Document Version: v. 1.3

© Copyright 2003 Alliance Semiconductor Corporation. All rights reserved. Our three-point logo, our name and Intelliwatt are trademarks or registered trademarks of Alliance. All other brand and product names may be the trademarks of their respective companies. Alliance reserves the right to make changes to this document and its products at any time without notice. Alliance assumes no responsibility for any errors that may appear in this document. The data contained herein represents Alliance's best data and/or estimates at the time of issuance. Alliance reserves the right to change or correct this data at any time, without notice. If the product described herein is under development, significant changes to these specifications are possible. The information in this product data sheet is intended to be general descriptive information for potential customers and users, and is not intended to operate as, or provide, any guarantee or warranty to any user or customer. Alliance does not assume any responsibility or liability arising out of the application or use of any product described herein, and disclaims any express or implied warranties related to the sale and/or use of Alliance products including liability or warranties related to fitness for a particular purpose, merchantability, or infringement of any intellectual property rights, except as expressly agreed to in Alliance's Terms and Conditions of Sale (which are available from Alliance). All sales of Alliance products are made exclusively according to Alliance's Terms and Conditions of Sale. The purchase of products from Alliance does not convey a license under any patent rights, copyrights; mask works rights, trademarks, or any other intellectual property rights of Alliance or third parties. Alliance does not authorize its products for use as critical components in life-supporting systems where a malfunction or failure may reasonably be expected to result in significant injury to the user, and the inclusion of Alliance products in such life-supporting systems implies that the manufacturer assumes all risk of such use and agrees to indemnify Alliance against all claims arising from such use.



Компания «ЭлектроПласт» предлагает заключение долгосрочных отношений при поставках импортных электронных компонентов на взаимовыгодных условиях!

Наши преимущества:

- Оперативные поставки широкого спектра электронных компонентов отечественного и импортного производства напрямую от производителей и с крупнейших мировых складов;
- Поставка более 17-ти миллионов наименований электронных компонентов;
- Поставка сложных, дефицитных, либо снятых с производства позиций;
- Оперативные сроки поставки под заказ (от 5 рабочих дней);
- Экспресс доставка в любую точку России;
- Техническая поддержка проекта, помощь в подборе аналогов, поставка прототипов;
- Система менеджмента качества сертифицирована по Международному стандарту ISO 9001;
- Лицензия ФСБ на осуществление работ с использованием сведений, составляющих государственную тайну;
- Поставка специализированных компонентов (Xilinx, Altera, Analog Devices, Intersil, Interpoint, Microsemi, Aeroflex, Peregrine, Syfer, Eurofarad, Texas Instrument, Miteq, Cobham, E2V, MA-COM, Hittite, Mini-Circuits, General Dynamics и др.);

Помимо этого, одним из направлений компании «ЭлектроПласт» является направление «Источники питания». Мы предлагаем Вам помощь Конструкторского отдела:

- Подбор оптимального решения, техническое обоснование при выборе компонента;
- Подбор аналогов;
- Консультации по применению компонента;
- Поставка образцов и прототипов;
- Техническая поддержка проекта;
- Защита от снятия компонента с производства.



Как с нами связаться

Телефон: 8 (812) 309 58 32 (многоканальный)

Факс: 8 (812) 320-02-42

Электронная почта: org@eplast1.ru

Адрес: 198099, г. Санкт-Петербург, ул. Калинина, дом 2, корпус 4, литера А.