

General Description

The MAX12930/MAX12931 evaluation kit (EV kit) provides a proven design to evaluate the MAX12930 or MAX12931 two channel digital isolators. Three types of evaluation boards are available to support the narrow-body and wide-body package types. Two boards are fully assembled, each with a MAX12931 narrow-body or MAX12931 wide-body isolator, and the third generic board has U1 unpopulated allowing the user to select a device from the family of narrow-body MAX12930/MAX12931 isolators.

The EV kit should be powered from two independent isolated power supplies with nominal output voltage in range from 1.71V to 5.5V. For evaluating the electrical parameters of the device without any isolation between the two sides, a single power supply can also be used.

The MAX1293XSEVKIT# comes with U1 unpopulated and supports the following digital isolators: MAX12930BASA+, MAX12930CASA+, MAX12930EASA+, MAX12930FASA+ MAX12931BASA+, MAX12931CASA+, MAX12931EASA+, MAX12931FASA+

Note: When ordering the MAX1293XS EV kit the engineer should request a sample of the desired unidirectional isolator IC that can be soldered to the PCB.

Features

- Broad Range of Data Transfer Rates (from DC to 150Mbps)
- Two Unidirectional Channels in the Same Direction (MAX12930) or Two Unidirectional Channels in the Opposite Direction (MAX12931)
- SMA Connectors for Easy Connection to External Equipment
- Wide Power Supply Voltage Range from 1.71V to 5.5V
- Guaranteed Up to 3.75kV_{RMS} Isolation (for the Narrow-Body SOIC Package) for 60s
- Guaranteed Up to 5kV_{RMS} Isolation (for the Wide-Body SOIC Package) for 60s

Ordering Information appears at end of data sheet.

Table 1: EV Kit Options

EVKIT PART #	TARGET DEVICE	PACKAGE TYPE	COMMENT
MAX1293XSEVKIT#	Not populated	8-SOIC narrow-body	Request samples of target device from Maxim
MAX12931BSEVKIT#	MAX12931BASA+	8-SOIC narrow-body	25Mbps IC populated
MAX12931BWEVKIT#	MAX12931BAWE+	16-SOIC wide-body	25Mbps IC populated

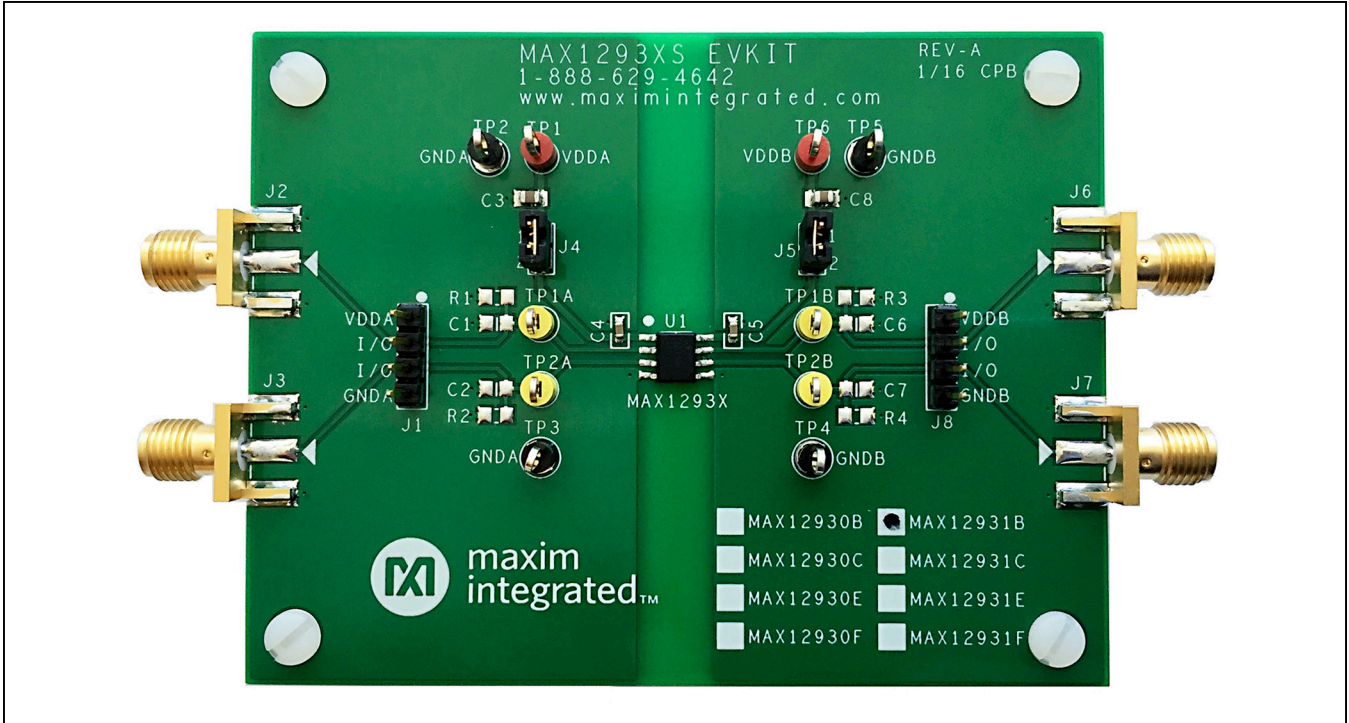

Figure 1. Narrow-Body MAX12931BS EVKIT

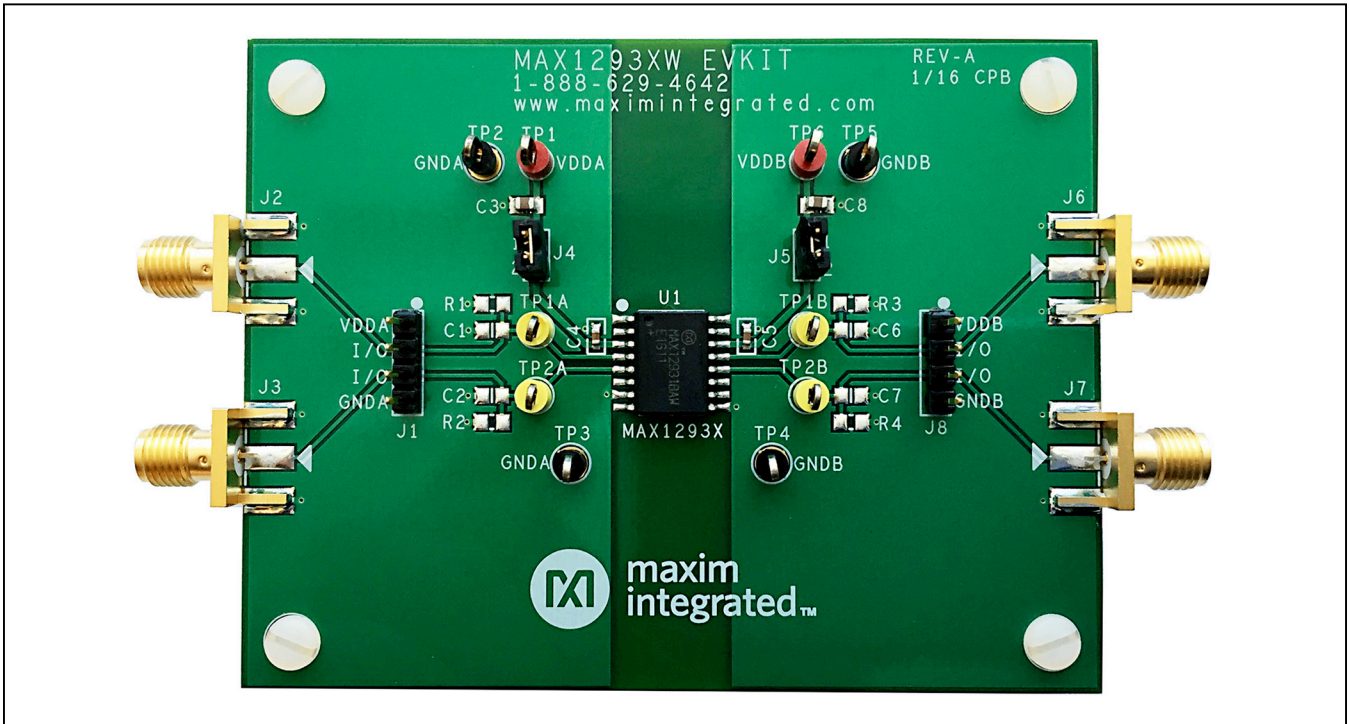

Figure 2. Wide-Body MAX12931BW EVKIT

Quick Start

Required Equipment

- MAX1293XS, or MAX12931BS, or MAX12931BW EV kit
- MAX1293X device, if EV kit is not populated
- Two adjustable +5V DC Power Supplies
- Signal/function generator
- Oscilloscope

Procedure

The MAX12931BS and MAX12931BW EV kits are fully assembled and ready for evaluation. The MAX1293XS EV kit has everything except the DUT (U1) installed. The user can install the desired version of the MAX12930/

MAX12931 family of two channel digital isolators. Once installed, follow the steps below to verify board functionality:

- 1) Connect the DC power supplies between the MAX1293X EV kit's V_{DDA}/V_{DDB} and $GNDA/GNDB$ test points.
- 2) Turn on the DC power supplies and set them between 1.71V and 5.5V, then enable the power supply output.
Note: *It is also possible to power the MAX1293X EV kit from a single power supply to test electrical parameters but this invalidates the digital isolation of the IC.*
- 3) Connect the signal/function generator to the SMA connectors or test points of side A and observe the isolated signal on the other side, side B, using an oscilloscope.

Table 2. MAX1293XS and MAX1293XW Board Connectors and Shunt Positions

CONNECTOR	SHUNT POSITION	DESCRIPTION
J1	1	Test point or input header for V_{DDA}
	2	Test point or input header for I/O; same as J2 SMA
	3	Test point or input header for I/O; same as J3 SMA
	4	Test point or input header for $GNDA$
J2 (SMA)	n/a	I/O on side A
J3 (SMA)	n/a	I/O on side A
J4	Open	Use ampere meter to measure current of side A
	1-2*	Connect power supply to V_{DDA}
J5	Open	Use ampere meter to measure current of side B
	1-2*	Connect power supply to V_{DDB}
J6 (SMA)	n/a	I/O on side B
J7 (SMA)	n/a	I/O on side B
J8	1	Test point or input header for V_{DDB}
	2	Test point or input header for I/O; same as J6 SMA
	3	Test point or input header for I/O; same as J7 SMA
	4	Test point or input header for $GNDB$

*Default configuration

Table 3. MAX1293XS and MAX1293XW Test Points

TEST POINT	DESCRIPTION
TP1	Test point for V_{DDA}
TP1A	Test point for SMA connector J2
TP1B	Test point for SMA connector J6
TP2, TP3	Test point for $GNDA$
TP2A	Test point for SMA connector J3
TP2B	Test point for SMA connector J7
TP4, TP5	Test point for $GNDB$
TP6	Test point for V_{DDB}

Detailed Description of Hardware

The MAX1293XS or MAX1293XW EV kit is powered from two external adjustable power supplies as described below.

External Power Supplies

Power to the MAX1293XS or MAX1293XW EV kit is derived from two external sources which can both be between +1.71V and +5.5V. Connect one source between the V_{DDA} and G_{NDA} test points, and another source between the V_{DDB} and G_{NDB} test points. Each supply can be set independently and can be present over the entire range from 1.71V to 5.5V, regardless of the level or presence of the other supply. The MAX12930/MAX12931 level-shifts the data, transmitting them across the isolation barrier.

Two SMA connectors on each side of the board allow easy connections to signal generator(s) and oscilloscope. A typical application diagram is shown in [Figure 3](#).

Decoupling Capacitors

Each power supply is decoupled with a 10µF ceramic capacitor placed close to the power supply test point, and a 0.1µF ceramic capacitor placed close to U1.

Termination

Each input and output has an unpopulated 0805 SMT resistor (R1-R4) and a 0805 SMT capacitor (C1, C2, C6, C7) to GND_ to allow termination based on customer requirements.

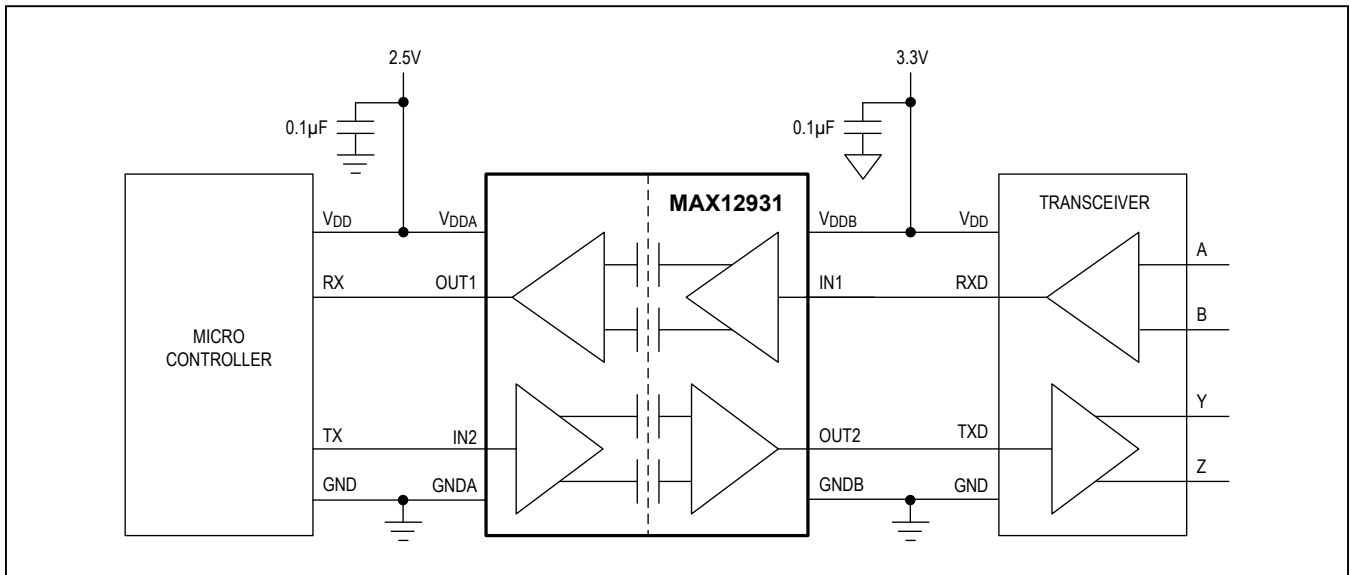

Figure 3. Typical Application Diagram

Component Information, PCB Layout, and Schematics

See the following links for component information, PCB layout, and schematics.

- [MAX1293XS EV BOM](#)
- [MAX1293XS EV PCB Layout](#)
- [MAX1293XS EV Schematic](#)
- [MAX12931BW EV BOM](#)
- [MAX12931BW EV PCB Layout](#)
- [MAX12931BW EV Schematic](#)

Ordering Information

PART	TYPE
MAX1293XSEVKIT#	EVKIT for narrow-body SOIC package
MAX12931BSEVKIT#	EVKIT with installed MAX12931BASA+
MAX12931BWEVKIT#	EVKIT with installed MAX12931BAWE+

#Denotes RoHS compliant.

The MAX1293XS EV kit comes with U1 unpopulated. Order the device with the required data rate and default state separately. Refer to the [Ordering Information](#) section of the MAX12930/MAX12931 data sheet.

Revision History

REVISION NUMBER	REVISION DATE	DESCRIPTION	PAGES CHANGED
0	6/16	Initial release	—

For pricing, delivery, and ordering information, please contact Maxim Direct at 1-888-629-4642, or visit Maxim Integrated's website at www.maximintegrated.com.

Maxim Integrated cannot assume responsibility for use of any circuitry other than circuitry entirely embodied in a Maxim Integrated product. No circuit patent licenses are implied. Maxim Integrated reserves the right to change the circuitry and specifications without notice at any time.

TITLE: Bill of Materials

DATE: 01/12/2016

DESIGN: max1293xs_evkit_a

NOTE: DNI--> DO NOT INSTALL ; DNP--> DO NOT PROCURE

ITEM	REF_DES	DNI/ DNP	QTY	MFG PART #	MANUFACTURER	VALUE	DESCRIPTION
1	C3, C8	-	2	ECJ-2FF1A106Z; CC0805ZKY5V6BB1	PANASONIC/YAGEO PHYCOMP	10UF	CAPACITOR; SMT (0805); CERAMIC CHIP; 10UF; 10V; TOL=+80%-20%; MODEL=Y5V; TG= -30 DEGC TO +85 DEGC; T;
2	C4, C5	-	2	GRM188R61C104KA01; EMK107BJ104KAH	MURATA/TAIYO YUDEN	0.1UF	CAPACITOR; SMT (0603); CERAMIC CHIP; 0.1UF; 16V; TOL=10%; MODEL=; TG=-55 DEGC TO +125 DEGC; TC=X5R;
3	J1, J8	-	2	PEC04SAAN	SULLINS ELECTRONICS CORP.	PEC04SAAN	CONNECTOR; MALE; THROUGH HOLE; BREAKAWAY; STRAIGHT; 4PINS
4	J2, J3, J6, J7	-	4	142-0701-851	JOHNSON COMPONENTS	142-0701-851	CONNECTOR; END LAUNCH JACK RECEPTACLE; BOARDMOUNT; STRAIGHT THROUGH; 2PINS;
5	J4, J5	-	2	PCC02SAAN	SULLINS	PCC02SAAN	CONNECTOR; MALE; THROUGH HOLE; BREAKAWAY; STRAIGHT THROUGH; 2PINS; -65 DEGC TO +125 DEGC
6	SU1, SU2	-	2	STC02SYAN	SULLINS ELECTRONICS CORP.	STC02SYAN	TEST POINT; JUMPER; STR; TOTAL LENGTH=0.256IN; BLACK; INSULATION=PBT CONTACT=PHOSPHOR BRONZE; COPPER PLATED TIN OVERALL
7	TP1, TP6	-	2	5010	KEYSTONE	N/A	TESTPOINT WITH 1.80MM HOLE DIA, RED, MULTIPURPOSE;
8	TP1A, TP1B, TP2A, TP2B	-	4	5009	KEYSTONE	N/A	TEST POINT; PIN DIA=0.125IN; TOTAL LENGTH=0.35IN; BOARD HOLE=0.063IN; YELLOW; PHOSPHOR BRONZE WIRE SILVER PLATE FINISH;
9	TP2-TP5	-	4	5011	KEYSTONE	N/A	TEST POINT; PIN DIA=0.125IN; TOTAL LENGTH=0.445IN; BOARD HOLE=0.063IN; BLACK; PHOSPHOR BRONZE WIRE SILVER PLATE FINISH;
10	MTH1-MTH4	DNI	4	EVKIT_STANDOFF_4-40_3/8	?	EVKIT_STANDOFF_4-40_3/8	KIT; ASSY-STANDOFF 3/8IN; 1PC. STANDOFF/FEM/HEX/4-40IN/(3/8IN)/NYLON; 1PC. SCREW/SLOT/PAN/4-40IN/(3/8IN)/NYLON
11	C1, C2, C6, C7	DNP	0	GRM2195C1H103JA01	MURATA	0.01UF	CAPACITOR; SMT; 0805; CERAMIC; 0.01uF; 50V; 5%; COG; -55degC to + 125degC; 0?30ppm/?C from -55degC to +125degC
12	R1-R4	DNP	0	ERJ-P06J472V	PANASONIC	4.7K	RESISTOR; 0805; 4.7K OHM; 5%; 200PPM; 0.25W; THICK FILM
13	PCB	-	1	MAX1293XS	MAXIM	PCB	PCB Board:MAX1293XS EVALUATION KIT
TOTAL			29				

MAX1293XS EVKIT
 1-888-629-4642
 www.maximintegrated.com

REV-A
 1/16 CPB

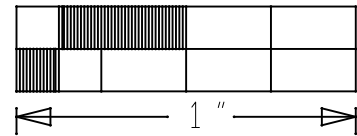
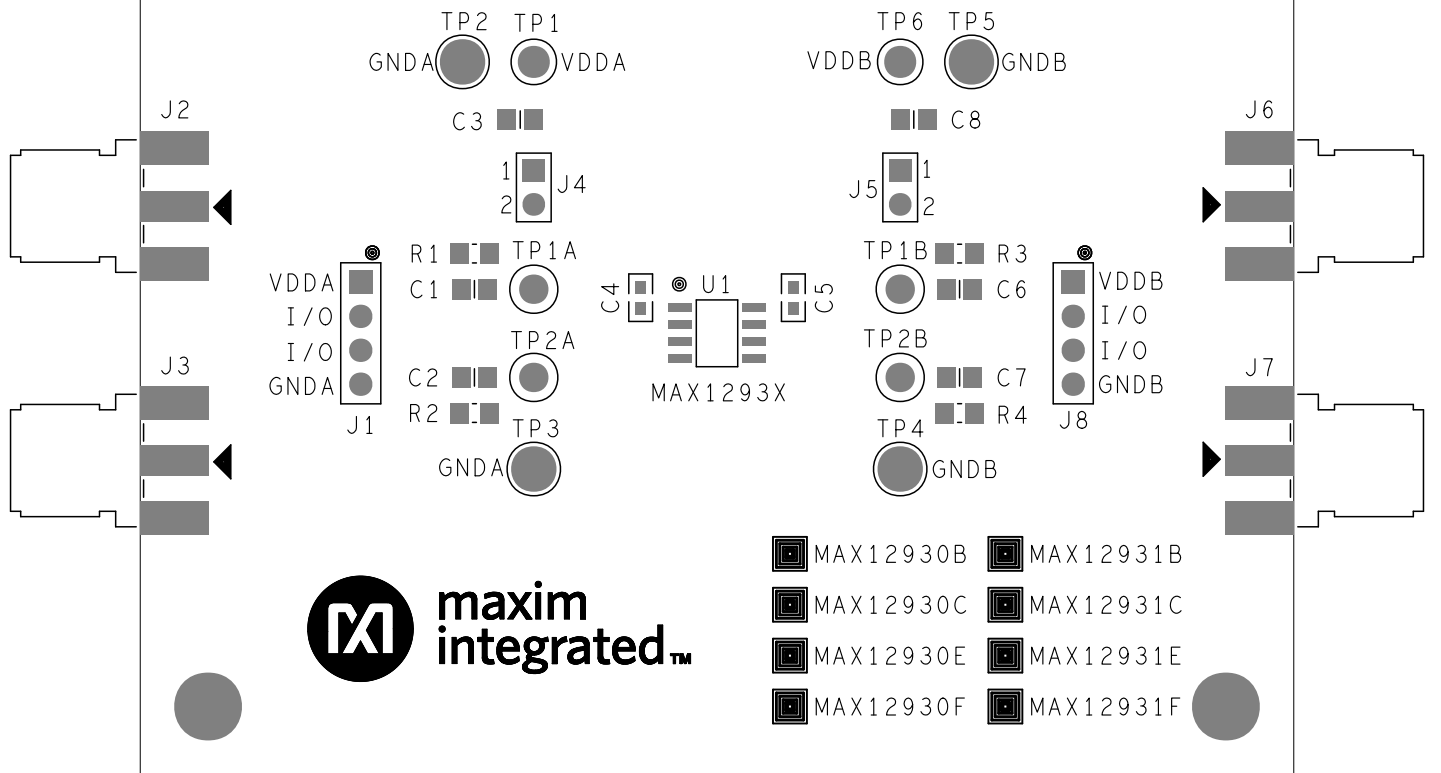

SILKSCREEN TOP

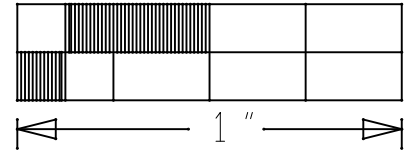
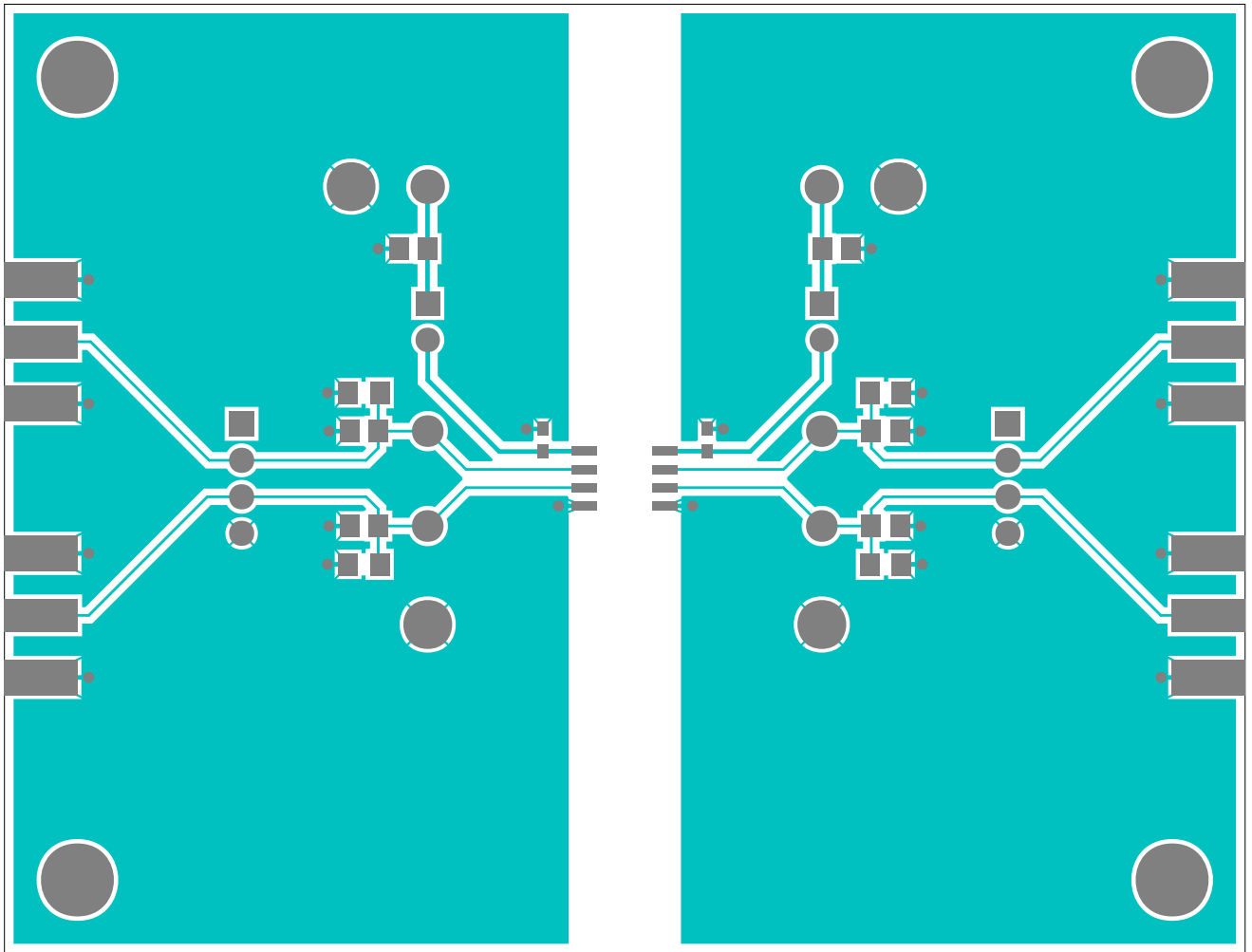

TOP

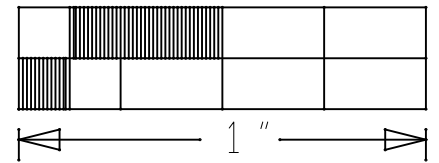
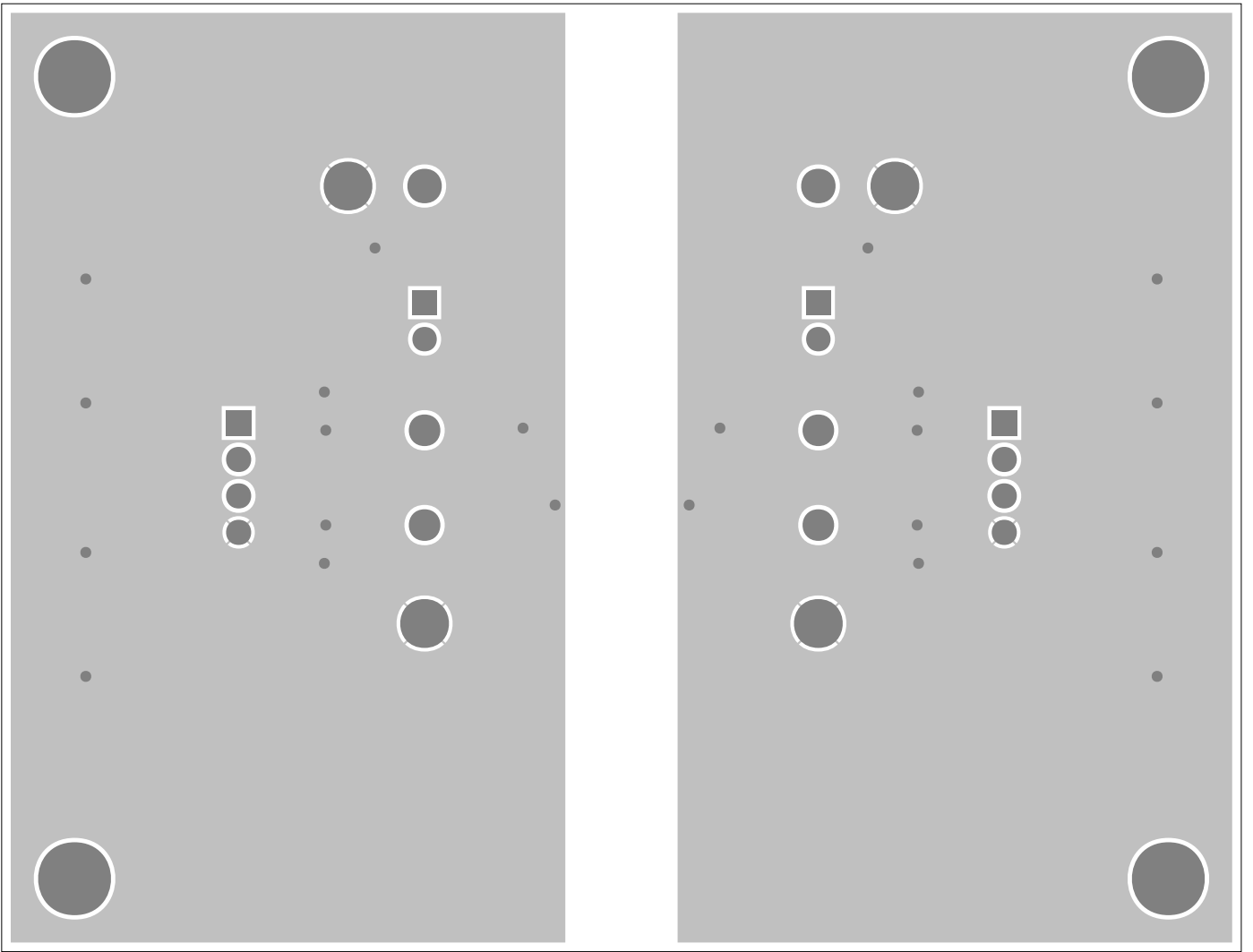

L2 GND

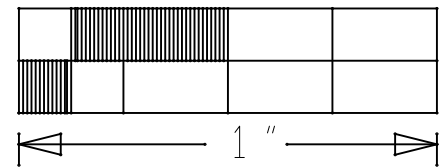
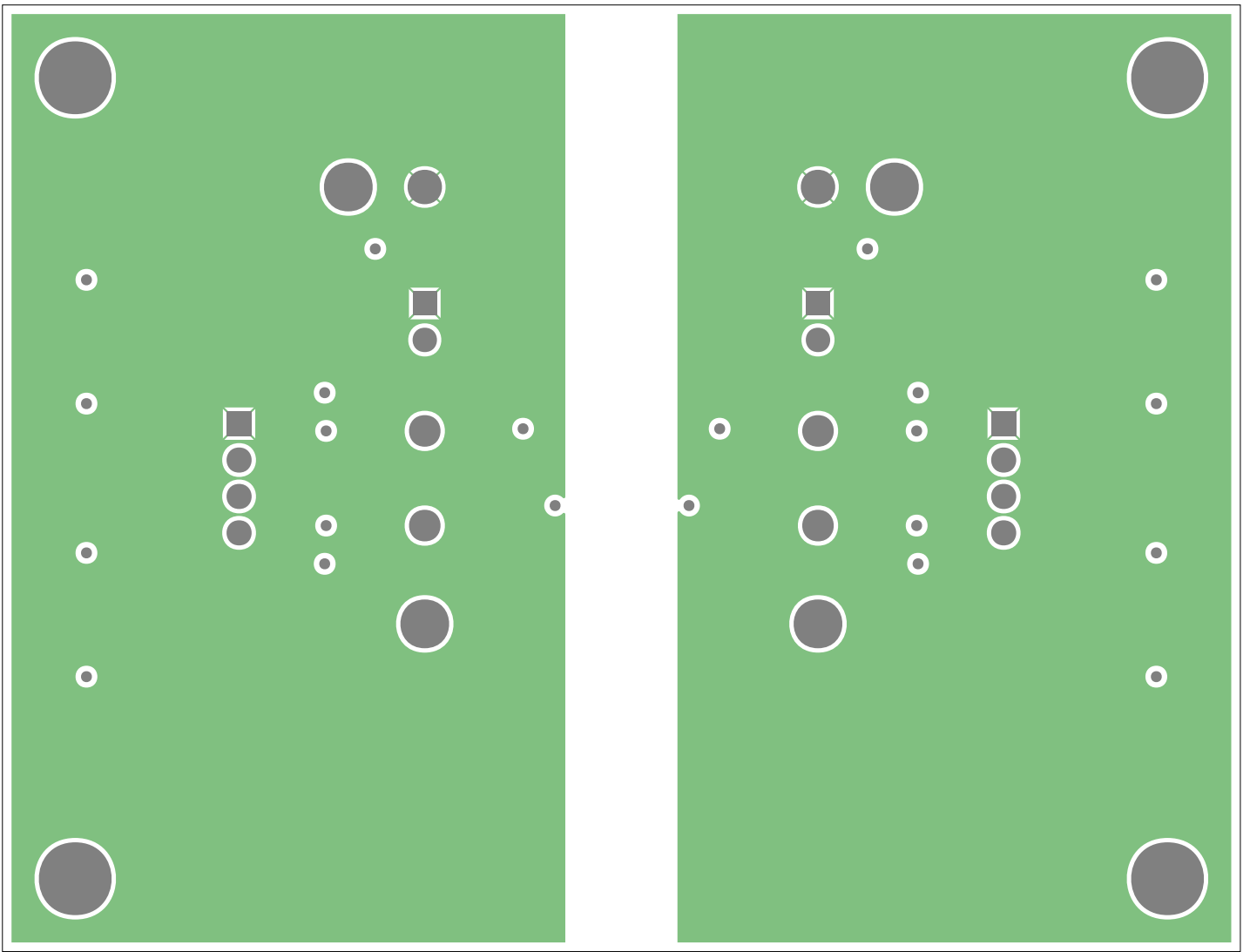

L3 PWR

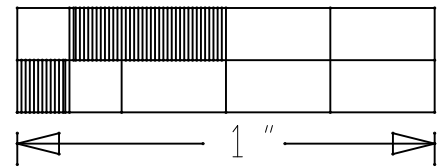
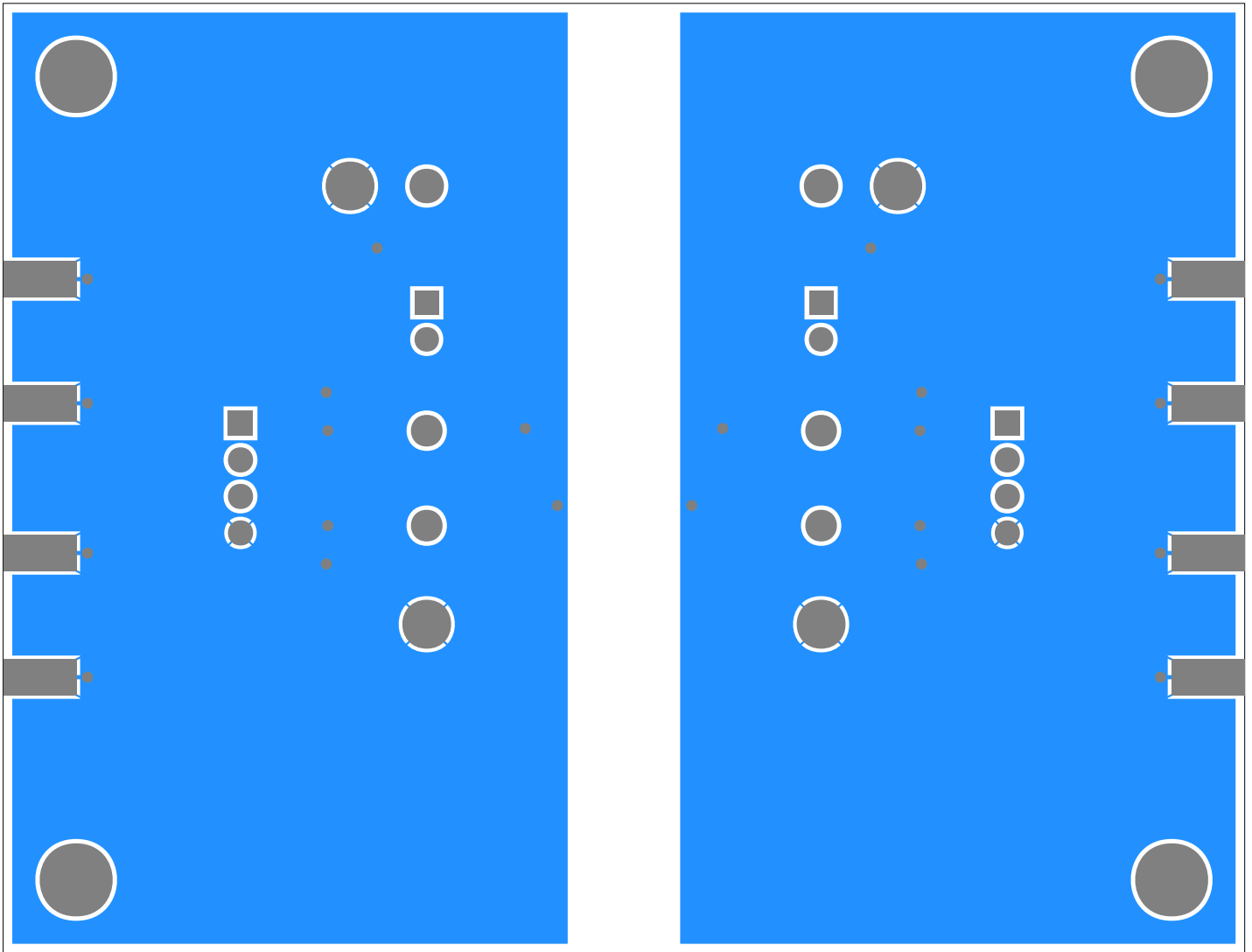

BOTTOM

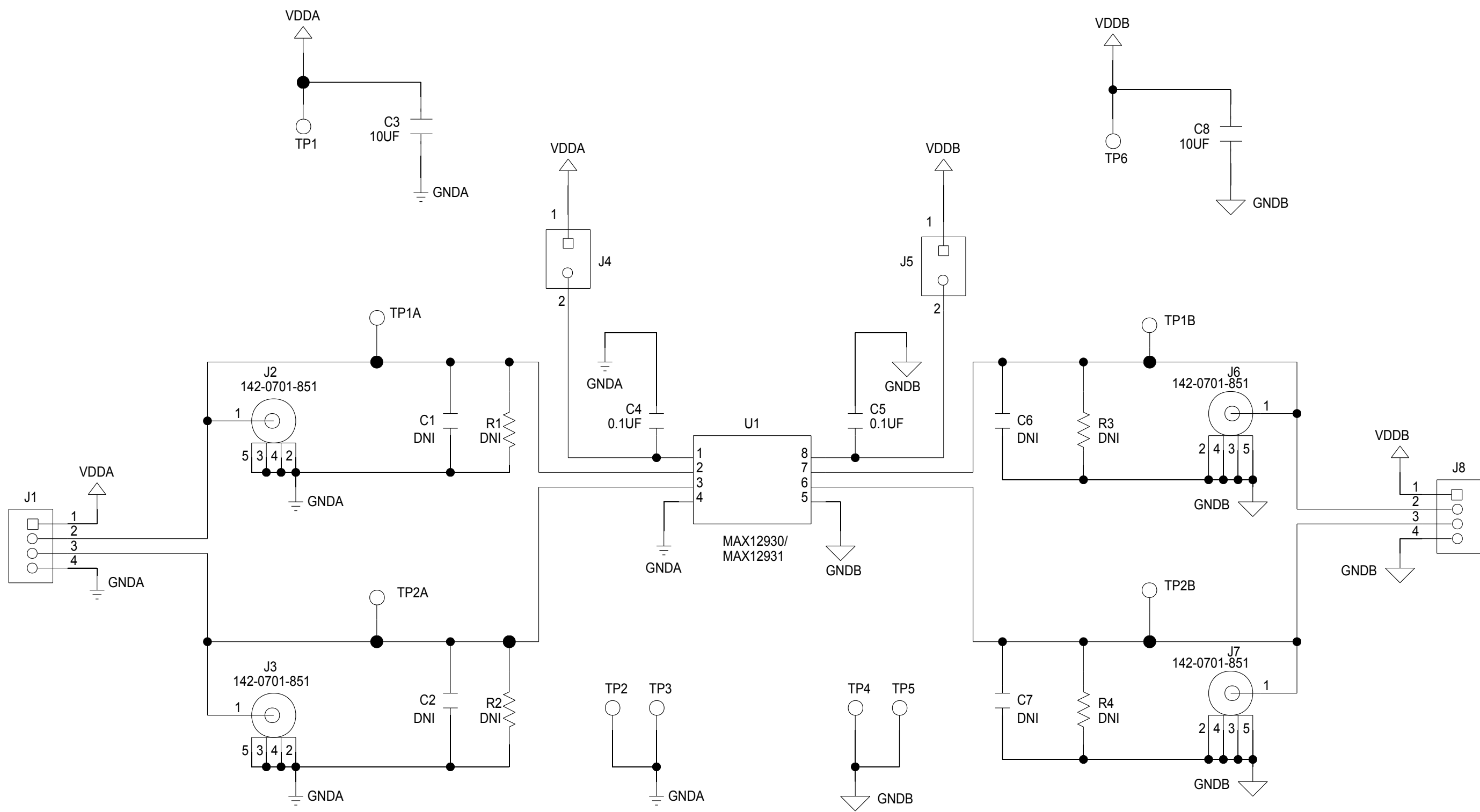

TITLE: Bill of Materials

DATE: 01/07/2016

DESIGN: max1293bw_evkit_a

NOTE: DNI--> DO NOT INSTALL ; DNP--> DO NOT PROCURE

ITEM	REF_DES	DNI/D NP	QTY	MFG PART #	MANUFACTU RER	VALUE	DESCRIPTION
1	C3, C8	-	2	ECJ-2FF1A106Z; CC0805ZKY5V6BB1	PANASONIC/Y AGEO PHYCOMP	10UF	CAPACITOR; SMT (0805); CERAMIC CHIP; 10UF; 10V; TOL=+80%-20%; MODEL=Y5V; TG= -30 DEGC TO +85 DEGC; T;
2	C4, C5	-	2	GRM188R61C104KA01; EMK107BJ104KAH	MURATA/TAIY O YUDEN	0.1UF	CAPACITOR; SMT (0603); CERAMIC CHIP; 0.1UF; 16V; TOL=10%; MODEL=; TG=-55 DEGC TO +125 DEGC; TC=X5R;
3	J1, J8	-	2	PEC04SAAN	SULLINS ELECTRONICS CORP.	PEC04SAAN	CONNECTOR; MALE; THROUGH HOLE; BREAKAWAY; STRAIGHT; 4PINS
4	J2, J3, J6, J7	-	4	142-0701-851	JOHNSON COMPONENTS	142-0701-851	CONNECTOR; END LAUNCH JACK RECEPTACLE; BOARDMOUNT; STRAIGHT THROUGH; 2PINS; CONNECTOR; MALE; THROUGH HOLE; BREAKAWAY; STRAIGHT THROUGH; 2PINS; -65 DEGC TO +125 DEGC
5	J4, J5	-	2	PCC02SAAN	SULLINS	PCC02SAAN	
6	SU1, SU2	-	2	STC02SYAN	SULLINS ELECTRONICS CORP.	STC02SYAN	TEST POINT; JUMPER; STR; TOTAL LENGTH=0.256IN; BLACK; INSULATION=PBT CONTACT=PHOSPHOR BRONZE; COPPER PLATED TIN OVERALL
7	TP1, TP6	-	2	5010	KEYSTONE	N/A	TESTPOINT WITH 1.80MM HOLE DIA, RED, MULTIPURPOSE;
8	TP1A, TP1B, TP2A, TP2B	-	4	5009	KEYSTONE	N/A	TEST POINT; PIN DIA=0.125IN; TOTAL LENGTH=0.35IN; BOARD HOLE=0.063IN; YELLOW; PHOSPHOR BRONZE WIRE SILVER PLATE FINISH;
9	TP2-TP5	-	4	5011	KEYSTONE	N/A	TEST POINT; PIN DIA=0.125IN; TOTAL LENGTH=0.445IN; BOARD HOLE=0.063IN; BLACK; PHOSPHOR BRONZE WIRE SILVER PLATE FINISH;
10	MTH1-MTH4	DNI	4	EVKIT_STANDOFF_4-40_3/8	?	EVKIT_STAND OFF_4-40_3/8	KIT; ASSY-STANDOFF 3/8IN; 1PC. STANDOFF/FEM/HEX/4-40IN/(3/8IN)/NYLON; 1PC. SCREW/SLOT/PAN/4-40IN/(3/8IN)/NYLON
11	C1, C2, C6, C7	DNP	0	GRM2195C1H103JA01	MURATA	0.01UF	CAPACITOR; SMT; 0805; CERAMIC; 0.01uF; 50V; 5%; COG; -55degC to + 125degC; 0?30ppm/?C from -55degC to +125degC
12	R1-R4	DNP	0	ERJ-P06J472V	PANASONIC	4.7K	RESISTOR; 0805; 4.7K OHM; 5%; 200PPM; 0.25W; THICK FILM
13	PCB	-	1	MAX1293XBW	MAXIM	PCB	PCB Board:MAX1293BW EVALUATION KIT
TOTAL			29				

MAX1293XW EVKIT
1-888-629-4642
www.maximintegrated.com

REV-A
1/16 CPB

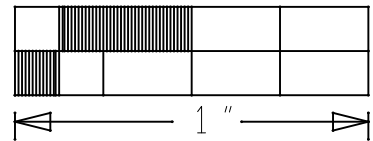
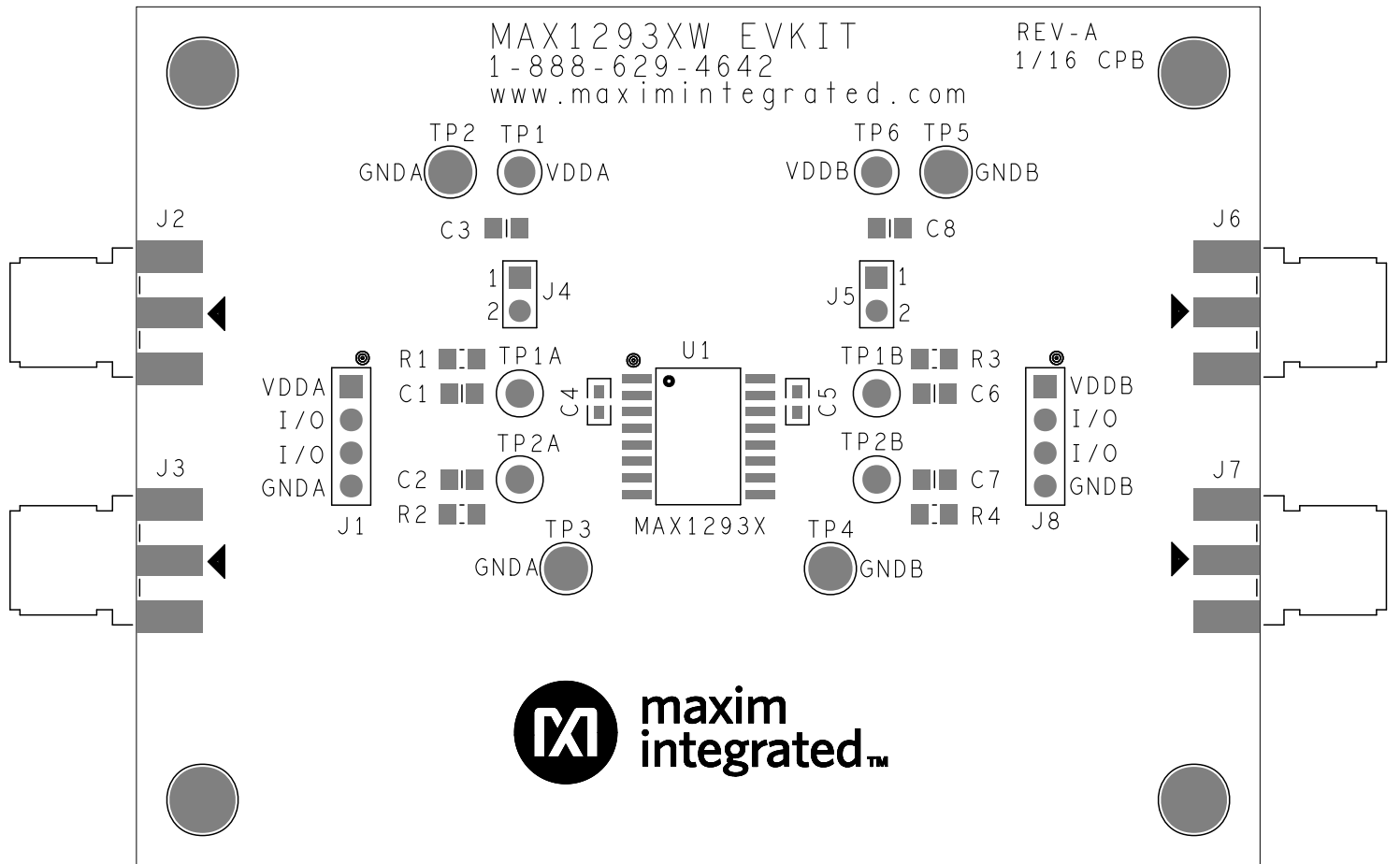

SILKSCREEN TOP

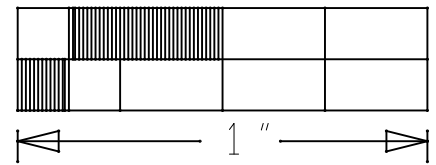
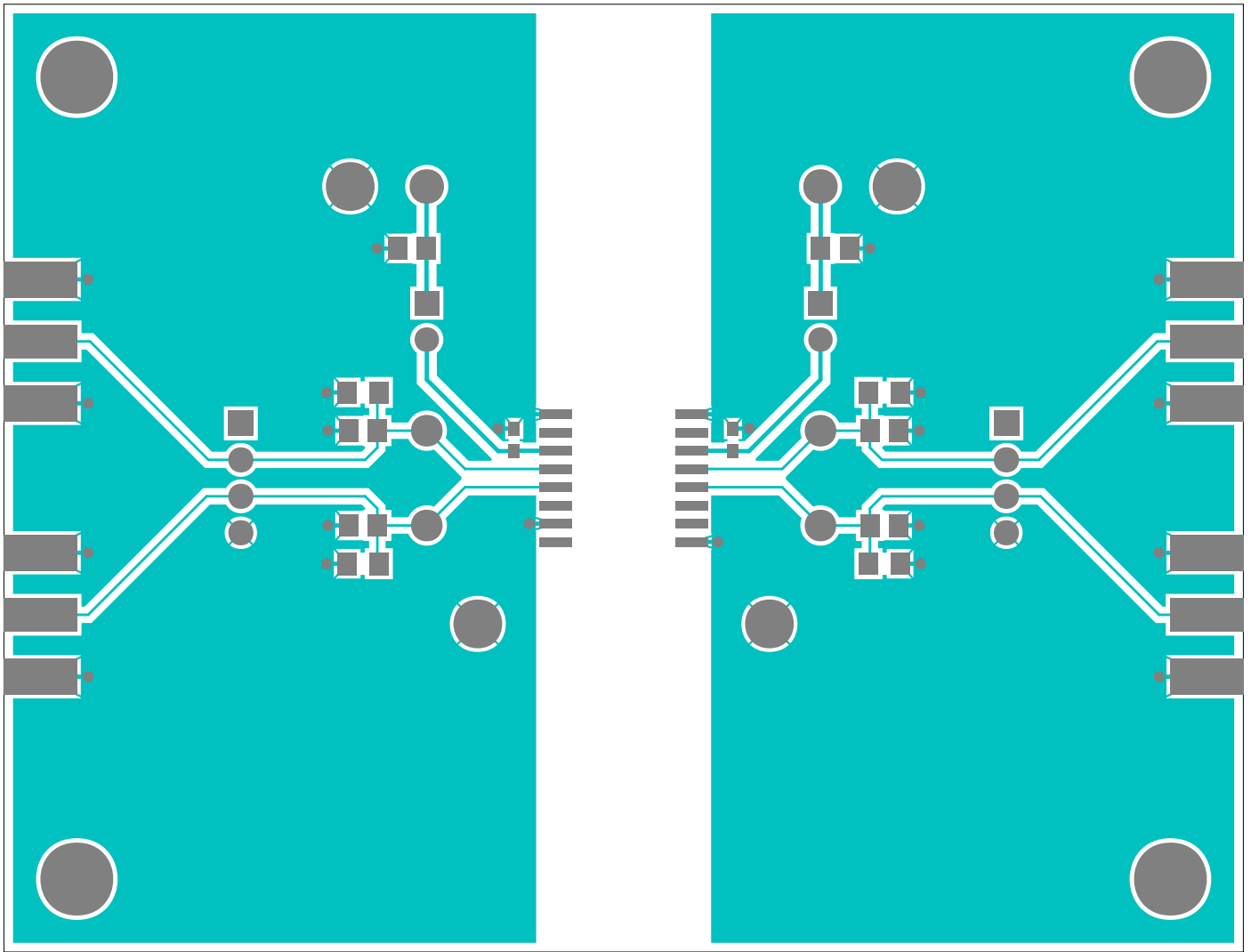

TOP

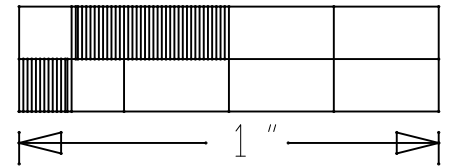
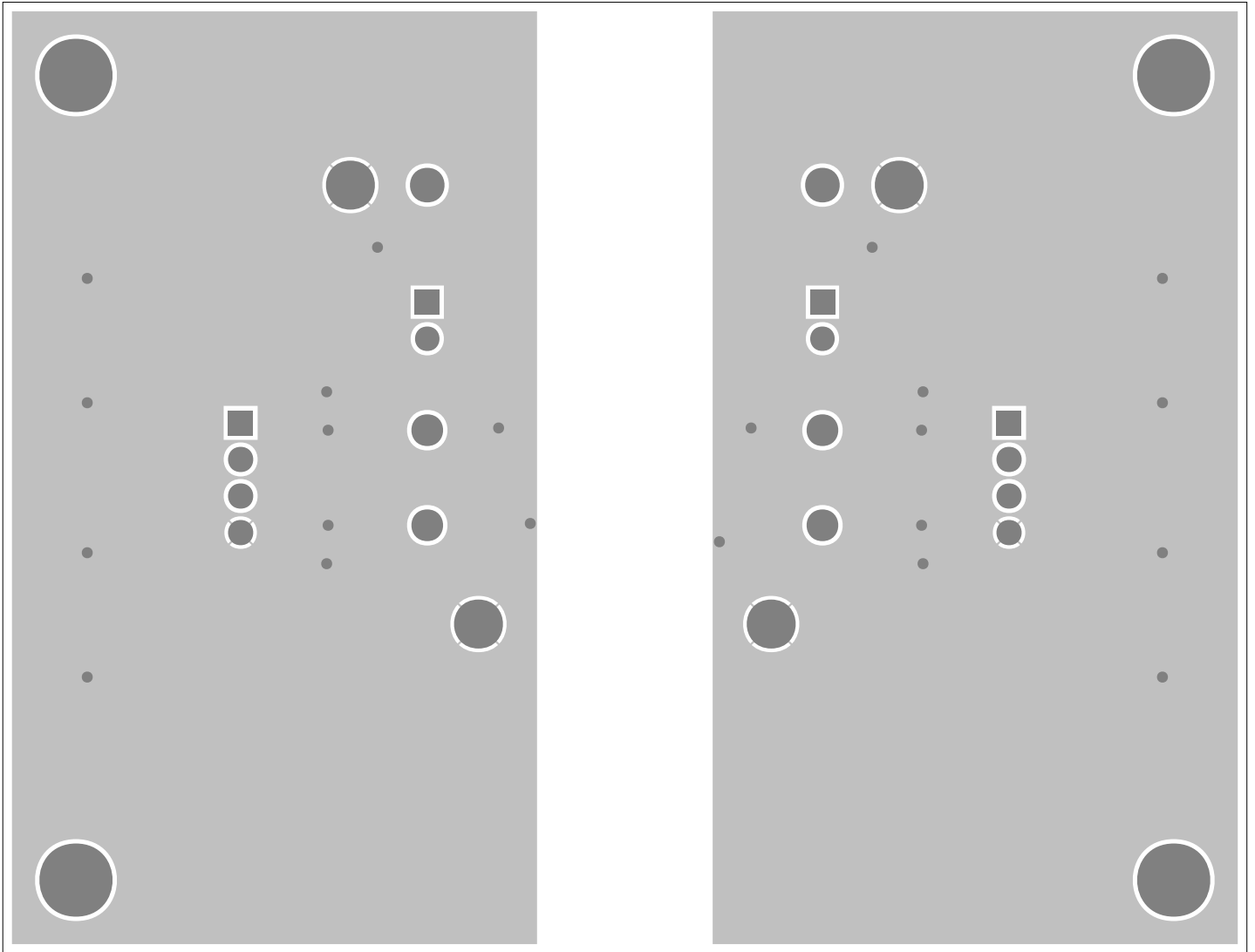

L2 GND

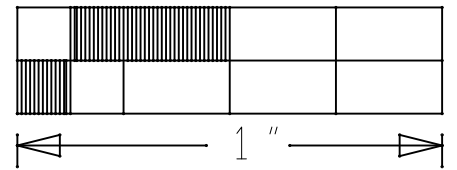
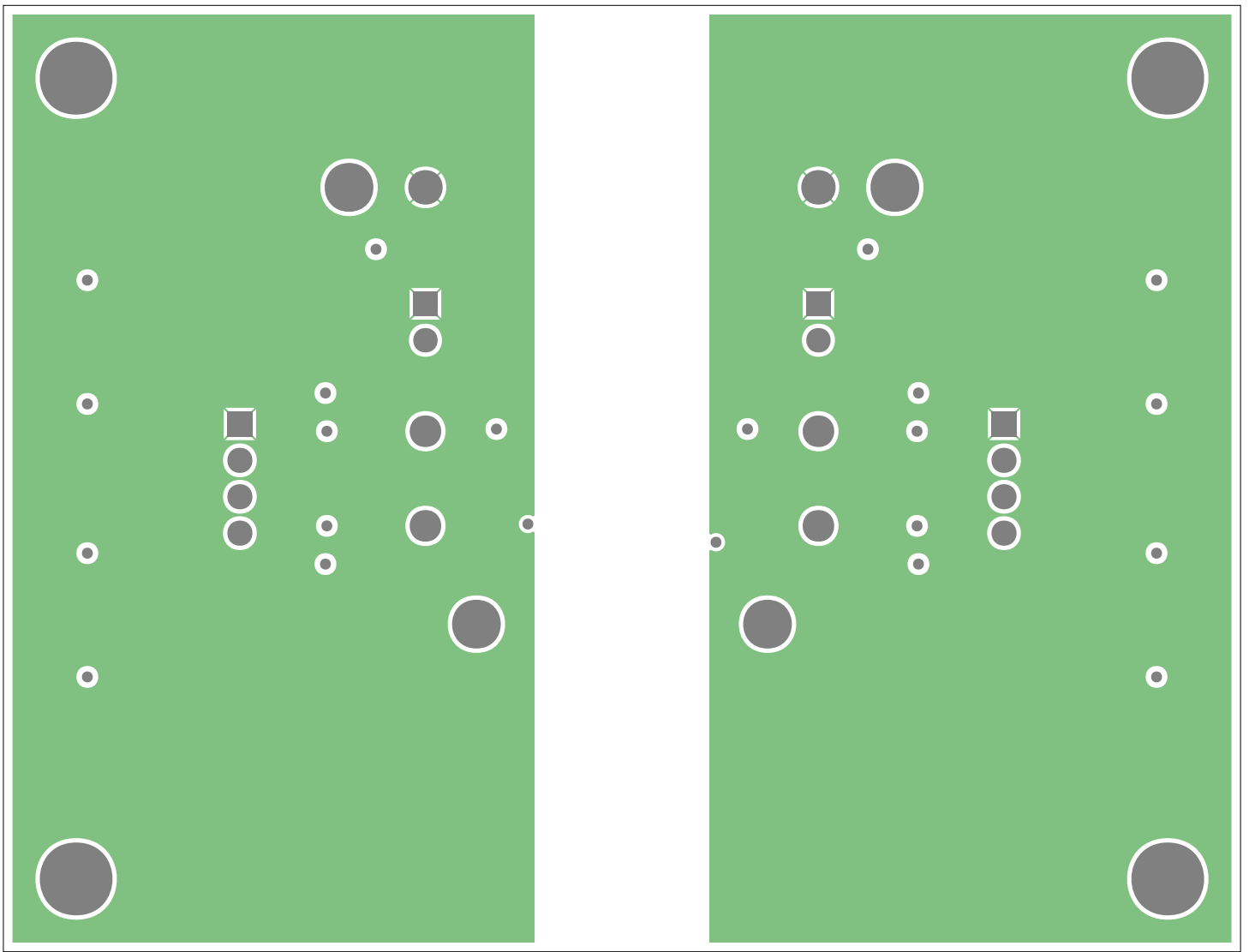

L3 PWR

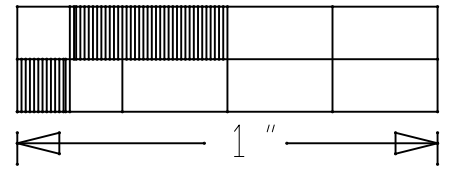
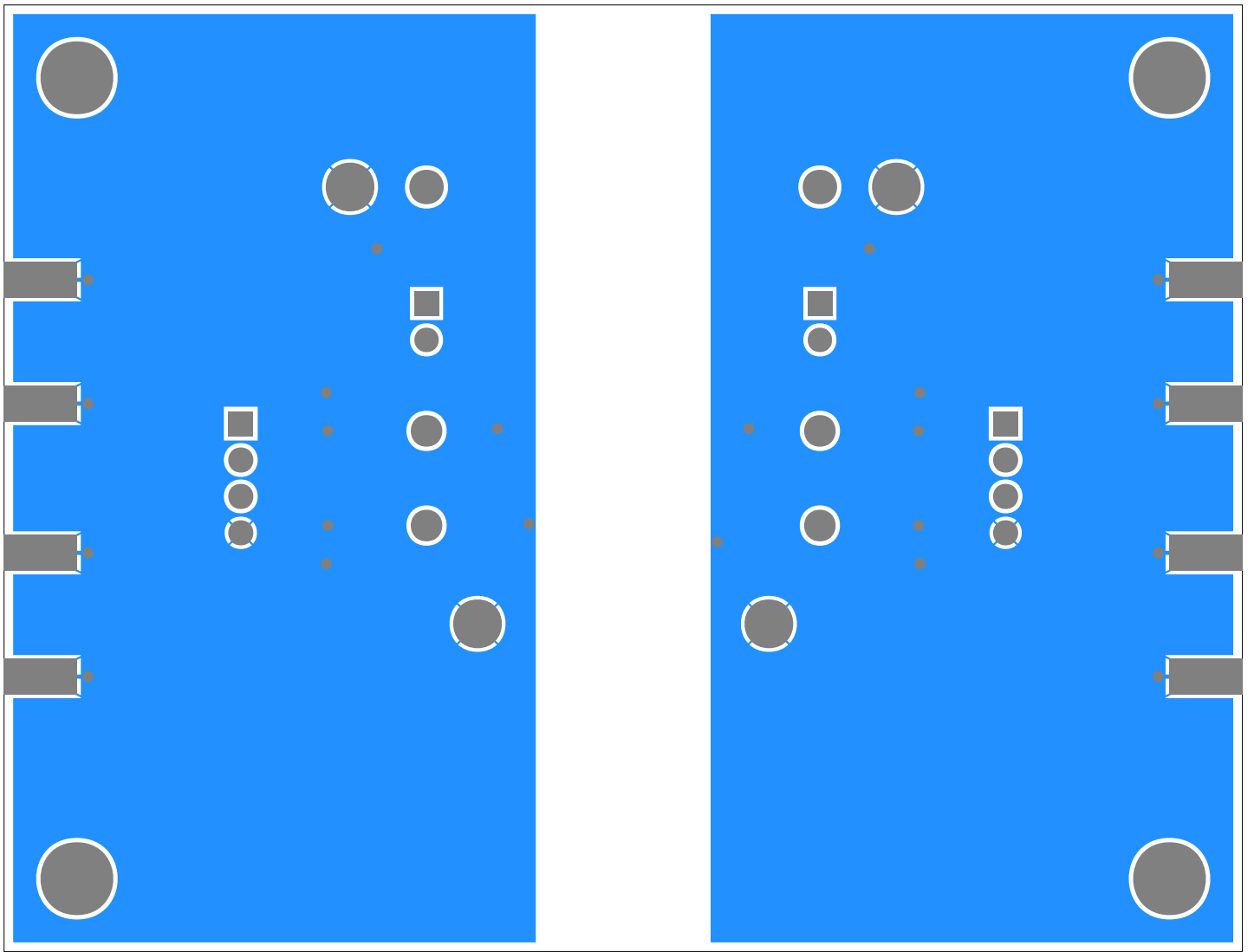

BOTTOM

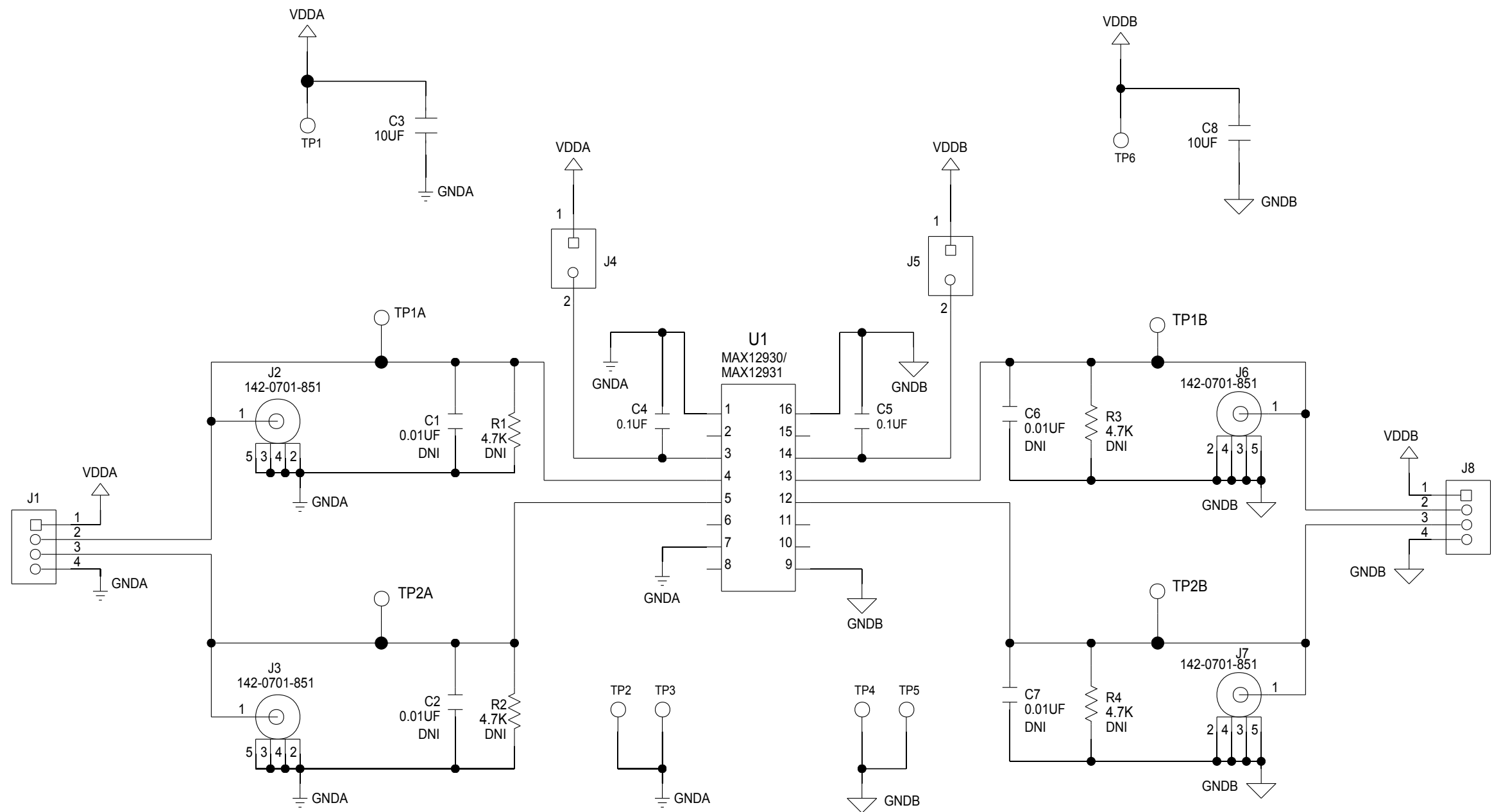



Компания «ЭлектроПласт» предлагает заключение долгосрочных отношений при поставках импортных электронных компонентов на взаимовыгодных условиях!

Наши преимущества:

- Оперативные поставки широкого спектра электронных компонентов отечественного и импортного производства напрямую от производителей и с крупнейших мировых складов;
- Поставка более 17-ти миллионов наименований электронных компонентов;
- Поставка сложных, дефицитных, либо снятых с производства позиций;
- Оперативные сроки поставки под заказ (от 5 рабочих дней);
- Экспресс доставка в любую точку России;
- Техническая поддержка проекта, помощь в подборе аналогов, поставка прототипов;
- Система менеджмента качества сертифицирована по Международному стандарту ISO 9001;
- Лицензия ФСБ на осуществление работ с использованием сведений, составляющих государственную тайну;
- Поставка специализированных компонентов (Xilinx, Altera, Analog Devices, Intersil, Interpoint, Microsemi, Aeroflex, Peregrine, Syfer, Eurofarad, Texas Instrument, Miteq, Cobham, E2V, MA-COM, Hittite, Mini-Circuits, General Dynamics и др.);

Помимо этого, одним из направлений компании «ЭлектроПласт» является направление «Источники питания». Мы предлагаем Вам помощь Конструкторского отдела:

- Подбор оптимального решения, техническое обоснование при выборе компонента;
- Подбор аналогов;
- Консультации по применению компонента;
- Поставка образцов и прототипов;
- Техническая поддержка проекта;
- Защита от снятия компонента с производства.



Как с нами связаться

Телефон: 8 (812) 309 58 32 (многоканальный)

Факс: 8 (812) 320-02-42

Электронная почта: org@eplast1.ru

Адрес: 198099, г. Санкт-Петербург, ул. Калинина, дом 2, корпус 4, литера А.