

# MAX4389/MAX4390/ MAX4392–MAX4396

# Ultra-Small, Low-Cost, 85MHz Op Amps with Rail-to-Rail Outputs and Disable

## General Description

The MAX4389/MAX4390/MAX4392–MAX4396 family of op amps are unity-gain stable devices that combine high-speed performance, rail-to-rail outputs, and disable mode. These devices are targeted for applications where an input or an output is exposed to the outside world, such as video and communications.

The MAX4389/MAX4390/MAX4392–MAX4396 operate from a single 4.5V to 11V supply or from dual  $\pm 2.25V$  to  $\pm 5.5V$  supplies. The common-mode input voltage range extends to the negative power-supply rail (ground in single-supply applications). The MAX4389/MAX4390/MAX4392–MAX4396 consume only 5.5mA of quiescent supply current per amplifier while achieving a 85MHz -3dB bandwidth, 27MHz 0.1dB gain flatness, and a 500V/ $\mu s$  slew rate. Disable mode sets the outputs to high impedance while consuming only 450 $\mu A$  of current.

The MAX4389 single, MAX4393 dual, MAX4394 triple, and MAX4396 quad include disable capabilities. The MAX4389 and MAX4390 are available in ultra-small, 6-pin SC70 packages.

## Applications

- Set-Top Boxes
- Surveillance Video Systems
- Analog-to-Digital Converter Interface
- CCD Imaging Systems
- Digital Cameras
- Video-on-Demand
- Video Line Driver

$\mu MAX$  is a registered trademark of Maxim Integrated Products, Inc.

## Typical Operating Circuit



## Features

- Low Cost
- High Speed
  - 85MHz -3dB Bandwidth
  - 27MHz 0.1dB Gain Flatness
  - 500V/ $\mu s$  Slew Rate
- Single 4.5V to 11V or Dual  $\pm 2.25V$  to  $\pm 5.5V$  Operation
- Rail-to-Rail Outputs
- Input Common-Mode Range Extends to  $V_{EE}$
- Low Differential Gain/Phase: 0.015%/0.015°
- Low Distortion at 5MHz
  - -59dBc Spurious-Free Dynamic Range
- High Output Drive:  $\pm 50mA$
- 450 $\mu A$  Disable Capability (MAX4389/MAX4393/MAX4394/MAX4396)
- Space-Saving SC70, SOT23,  $\mu MAX$ ®, or TSSOP Packages

## Ordering Information

PART	TEMP RANGE	PIN-PACKAGE	TOP MARK
MAX4389EXT+T	-40°C to +85°C	6 SC70	ABF
MAX4389EUT+T	-40°C to +85°C	6 SOT23	ABDC
MAX4390EXT+T	-40°C to +85°C	6 SC70	ABE
MAX4390EUK+T	-40°C to +85°C	5 SOT23	ADZM

+Denotes a lead(Pb)-free/RoHs-compliant package.  
T = Tape and reel.

Ordering Information continued at end of data sheet.  
Selector Guide appears at end of data sheet.

## Pin Configurations



### Absolute Maximum Ratings

Supply Voltage ( $V_{CC}$ to $V_{EE}$ )	-0.3V to +12V	8-Pin SO (derate 5.88mW/°C above +70°C)	471mW
$IN_+$ , $IN_-$ , $OUT_-$ , $DISABLE$	( $V_{EE} - 0.3V$ ) to ( $V_{CC} + 0.3V$ )	8-Pin $\mu$ MAX (derate 4.5mW/°C above +70°C)	362mW
Differential Input Voltage	$\pm 2.5V$	10-Pin $\mu$ MAX (derate 5.6mW/°C above +70°C)	444mW
Current into Input Pins	$\pm 20mA$	14-Pin SO (derate 8.33mW/°C above +70°C)	667mW
Output Short-Circuit Duration to		14-Pin TSSOP (derate 10mW/°C above +70°C)	727mW
$V_{CC}$ or $V_{EE}$ (Note 1)	Continuous	20-Pin TSSOP (derate 10.9mW/°C above +70°C)	879mW
Continuous Power Dissipation ( $T_A = +70^\circ C$ )		Operating Temperature Range	-40°C to +85°C
5-Pin SOT23 (derate 7.1mW/°C above +70°C)	571mW	Junction Temperature	+150°C
6-Pin SOT23 (derate 8.7mW/°C above +70°C)	696mW	Storage Temperature Range	-65°C to +150°C
6-Pin SC70 (derate 3.1mW/°C above +70°C)	245mW	Lead Temperature (soldering, 10s)	+300°C

**Note 1:** Continuous power dissipation must also be observed.

Stresses beyond those listed under "Absolute Maximum Ratings" may cause permanent damage to the device. These are stress ratings only, and functional operation of the device at these or any other conditions beyond those indicated in the operational sections of the specifications is not implied. Exposure to absolute maximum rating conditions for extended periods may affect device reliability.

### DC Electrical Characteristics—Single Supply

( $V_{CC} = 5V$ ,  $V_{EE} = 0V$ ,  $V_{CM} = V_{CC}/2$ ,  $V_{OUT} = V_{CC}/2$ ,  $R_L = \infty$  to  $V_{CC}/2$ ,  $DISABLE_- = V_{CC}$  (MAX4389/MAX4393/MAX4394/MAX4396),  $T_A = T_{MIN}$  to  $T_{MAX}$ , unless otherwise noted. Typical values are at  $T_A = +25^\circ C$ .) (Note 2)

PARAMETER	SYMBOL	CONDITIONS	MIN	TYP	MAX	UNITS
Input Common-Mode Voltage Range	$V_{CM}$	Guaranteed by CMRR test	$V_{EE} - 0.2$		$V_{CC} - 2.25$	V
Input Offset Voltage	$V_{OS}$	$T_A = +25^\circ C$		5	18	mV
		$T_A = -40^\circ C$ to $+85^\circ C$			26	
Input Offset Voltage Matching		MAX4392–MAX4396		1		mV
Input Offset Voltage Tempco	$TC_{VOS}$			15		$\mu V/^\circ C$
Input Bias Current	$I_B$			2.5	15	$\mu A$
Input Offset Current	$I_{OS}$			0.2	5	$\mu A$
Input Resistance	$R_{IN}$	Differential mode ( $-1V \leq V_{IN} \leq +1V$ )		70		k $\Omega$
		Common mode ( $-0.2V \leq V_{CM} \leq +2.75V$ )		3		M $\Omega$
Common-Mode Rejection Ratio	CMRR	$(V_{EE} - 0.2V) \leq V_{CM} \leq (V_{CC} - 2.25V)$	70	95		dB
Open-Loop Gain	$A_{VOL}$	$0.25V \leq V_{OUT} \leq 4.75V$ , $R_L = 2k\Omega$	50	70		dB
		$0.8V \leq V_{OUT} \leq 4.5V$ , $R_L = 150\Omega$	50	60		
		$1V \leq V_{OUT} \leq 4V$ , $R_L = 50\Omega$		58		
Output Voltage Swing	$V_{OUT}$	$R_L = 2k\Omega$	$V_{CC} - V_{OH}$	0.065	0.25	V
			$V_{OL} - V_{EE}$	0.05	0.15	
		$R_L = 150\Omega$	$V_{CC} - V_{OH}$	0.3	0.5	
			$V_{OL} - V_{EE}$	0.25	0.5	
		$R_L = 75\Omega$	$V_{CC} - V_{OH}$	0.5	0.8	
			$V_{OL} - V_{EE}$	0.45	0.8	
$R_L = 75\Omega$ to ground	$V_{CC} - V_{OH}$	1	1.7			
	$V_{OL} - V_{EE}$	0.025	0.1			
Output Current	$I_{OUT}$	Sinking from $R_L = 75\Omega$ to $V_{CC}$	40	55		mA
		Sourcing into $R_L = 75\Omega$ to $V_{EE}$	40	50		
Output Short-Circuit Current	$I_{SC}$	Sinking or sourcing		$\pm 100$		mA

### DC Electrical Characteristics—Single Supply (continued)

( $V_{CC} = 5V$ ,  $V_{EE} = 0V$ ,  $V_{CM} = V_{CC}/2$ ,  $V_{OUT} = V_{CC}/2$ ,  $R_L = \infty$  to  $V_{CC}/2$ ,  $\overline{DISABLE} = V_{CC}$  (MAX4389/MAX4393/MAX4394/MAX4396),  $T_A = T_{MIN}$  to  $T_{MAX}$ , unless otherwise noted. Typical values are at  $T_A = +25^\circ C$ .) (Note 2)

PARAMETER	SYMBOL	CONDITIONS	MIN	TYP	MAX	UNITS
Open-Loop Output Resistance	$R_{OUT}$			8		$\Omega$
Power-Supply Rejection Ratio	PSRR	$V_{EE} = 0V$ , $V_{CC} = 4.5V$ to $5.5V$	48	65		dB
Operating Supply Voltage Range	$V_S$	Guaranteed by PSRR	4.5		11	V
Disabled Output Resistance	$R_{OUT(OFF)}$	$\overline{DISABLE} = 0V$ , $0 \leq V_{OUT} \leq 5V$	40	95		k $\Omega$
$\overline{DISABLE}$ Logic-Low Threshold	$V_{IL}$				$V_{CC} - 3$	V
$\overline{DISABLE}$ Logic-High Threshold	$V_{IH}$		$V_{CC} - 1.25$			V
$\overline{DISABLE}$ Logic-Input Low Current	$I_{IL}$	$\overline{DISABLE} = 0V$		20	60	$\mu A$
$\overline{DISABLE}$ Logic-Input High Current	$I_{IH}$	$\overline{DISABLE} = V_{CC}$		5	40	$\mu A$
Quiescent Supply Current (Per Amplifier)	$I_S$	$\overline{DISABLE} = V_{CC}$		3.2	5	mA
		$\overline{DISABLE} = 0V$		0.3	0.4	

### DC Electrical Characteristics—Dual Supply

( $V_{CC} = 5V$ ,  $V_{EE} = -5V$ ,  $V_{CM} = 0V$ ,  $V_{OUT} = 0V$ ,  $R_L = \infty$  to  $0$ ,  $\overline{DISABLE} = V_{CC}$  (MAX4389/MAX4393/MAX4394/MAX4396),  $T_A = T_{MIN}$  to  $T_{MAX}$ , unless otherwise noted. Typical values are at  $T_A = +25^\circ C$ .) (Note 2)

PARAMETER	SYMBOL	CONDITIONS	MIN	TYP	MAX	UNITS
Input Common-Mode Voltage	$V_{CM}$	Guaranteed by CMRR test	$V_{EE}$	$V_{CC} - 2.25$		V
Input Offset Voltage	$V_{OS}$	$T_A = +25^\circ C$		7	20	mV
		$T_A = -40^\circ C$ to $+85^\circ C$			28	
Input Offset Voltage Matching		MAX4392–MAX4396		1		mV
Input Offset Voltage Tempco	$TC_{VOS}$			20		$\mu V/^\circ C$
Input Bias Current	$I_B$			5	15	$\mu A$
Input Offset Current	$I_{OS}$			0.5	5	$\mu A$
Input Resistance	$R_{IN}$	Differential mode ( $-1V \leq V_{IN} \leq +1V$ )		70		k $\Omega$
		Common mode ( $-0.2V \leq V_{CM} \leq +2.75V$ )		3		M $\Omega$
Common-Mode Rejection Ratio	CMRR	$V_{EE} \leq V_{CM} \leq (V_{CC} - 2.25V)$	70	90		dB
Open-Loop Gain	$A_{VOL}$	$-4.5V \leq V_{OUT} \leq 4.5V$ , $R_L = 2k\Omega$	65	80		dB
		$-4.25V \leq V_{OUT} \leq 4.25V$ , $R_L = 150\Omega$	50	60		

### DC Electrical Characteristics—Dual Supply (continued)

( $V_{CC} = 5V$ ,  $V_{EE} = -5V$ ,  $V_{CM} = 0V$ ,  $V_{OUT} = 0V$ ,  $R_L = \infty$  to 0,  $\overline{DISABLE} = V_{CC}$  (MAX4389/MAX4393/MAX4394/MAX4396),  $T_A = T_{MIN}$  to  $T_{MAX}$ , unless otherwise noted. Typical values are at  $T_A = +25^\circ C$ .) (Note 2)

PARAMETER	SYMBOL	CONDITIONS	MIN	TYP	MAX	UNITS
Output Voltage Swing	$V_{OUT}$	$R_L = 2k\Omega$	$V_{CC} - V_{OH}$	0.175	0.3	V
			$V_{OL} - V_{EE}$	0.075	0.2	
		$R_L = 150\Omega$	$V_{CC} - V_{OH}$	0.575	0.85	
			$V_{OL} - V_{EE}$	0.4	1.5	
		$R_L = 75\Omega$	$V_{CC} - V_{OH}$	1.5	2.35	
			$V_{OL} - V_{EE}$	0.75	1.6	
Output Current	$I_{OUT}$	Sinking from $R_L = 75\Omega$ to $V_{CC}$	50	95	mA	
		Sourcing into $R_L = 75\Omega$ to $V_{EE}$	50	75		
Output Short-Circuit Current	$I_{SC}$	Sinking or sourcing	±100			mA
Open-Loop Output Resistance	$R_{OUT}$		8			$\Omega$
Power-Supply Rejection Ratio	PSRR	$V_{EE} = 0V$ , $V_{CC} = 4.5V$ to $5.5V$	48	60		dB
Operating Supply Voltage Range	$V_S$	Guaranteed by PSRR	4.5		11	V
Disabled Output Resistance	$R_{OUT(OFF)}$	$\overline{DISABLE} = 0V$ , $-5V \leq V_{OUT} \leq +5V$	40	95		k $\Omega$
$\overline{DISABLE}$ Logic-Low Threshold	$V_{IL}$		$V_{CC} - 3$			V
$\overline{DISABLE}$ Logic-High Threshold	$V_{IH}$		$V_{CC} - 1.25$			V
Quiescent Supply Current (Per Amplifier)	$I_S$	$\overline{DISABLE} = V_{CC}$		6	10	mA
		$\overline{DISABLE} = 0V$		0.45	0.8	

### AC Electrical Characteristics—Single Supply

( $V_{CC} = 5V$ ,  $V_{EE} = 0V$ ,  $V_{CM} = 1.5V$ ,  $R_L = 100\Omega$  to  $V_{CC}/2$ ,  $\overline{DISABLE} = V_{CC}$  (MAX4389/MAX4393/MAX4394/MAX4396),  $V_{OUT} = V_{CC}/2$ ,  $A_{VCL} = 1V/V$ ,  $T_A = +25^\circ C$ , unless otherwise noted.)

PARAMETER	SYMBOL	CONDITIONS	MIN	TYP	MAX	UNITS
Small-Signal -3dB Bandwidth	$BW_{SS}$	$V_{OUT} = 100mV_{P-P}$		72		MHz
Large-Signal -3dB Bandwidth	$BW_{LS}$	$V_{OUT} = 2V_{P-P}$		80		MHz
Small-Signal 0.1dB Gain Flatness	$BW_{0.1dBSS}$	$V_{OUT} = 100mV_{P-P}$		30		MHz
Large-Signal 0.1dB Gain Flatness	$BW_{0.1dBLS}$	$V_{OUT} = 2V_{P-P}$		30		MHz
Slew Rate	SR	$V_{OUT} = 2V$ step		500		V/ $\mu s$
Settling Time to 0.1%	$t_s$	$V_{OUT} = 2V$ step		28		ns
Rise/Fall Time	$t_R/t_F$	$V_{OUT} = 100mV_{P-P}$		4		ns
Spurious-Free Dynamic Range	SFDR	$f_C = 5MHz$ , $V_{OUT} = 2V_{P-P}$		-59		dBc

### AC Electrical Characteristics—Single Supply (continued)

( $V_{CC} = 5V$ ,  $V_{EE} = 0V$ ,  $V_{CM} = 1.5V$ ,  $R_L = 100\Omega$  to  $V_{CC}/2$ ,  $\overline{DISABLE}_- = V_{CC}$  (MAX4389/MAX4393/MAX4394/MAX4396),  $V_{OUT} = V_{CC}/2$ ,  $A_{VCL} = 1V/V$ ,  $T_A = +25^\circ C$ , unless otherwise noted.)

PARAMETER	SYMBOL	CONDITIONS	MIN	TYP	MAX	UNITS
Differential Phase Error	DP	NTSC, $R_L = 150\Omega$		0.015		degrees
Differential Gain Error	DG	NTSC, $R_L = 150\Omega$		0.015		%
Input Noise-Voltage Density	$e_n$	$f = 10kHz$		13		$nV/\sqrt{Hz}$
Input Noise-Current Density	$i_n$	$f = 10kHz$		2.1		$pA/\sqrt{Hz}$
Input Capacitance	$C_{IN}$			1		pF
Output Impedance	$Z_{OUT}$	$f = 5MHz$		0.6		$\Omega$
Disable OFF Time		MAX4389/MAX4393/MAX4394/MAX4396		80		ns
Disable ON Time		MAX4389/MAX4393/MAX4394/MAX4396		40		ns
Channel-to-Channel Isolation	$CH_{ISO}$	MAX4392–MAX4396, specified at DC		-97		dB

### AC Electrical Characteristics —Dual Supply

( $V_{CC} = 5V$ ,  $V_{EE} = -5V$ ,  $R_L = \infty$  to GND,  $GND = 0$ ,  $V_{OUT} = 0V$ ,  $Gain = 1V/V$ ,  $\overline{DISABLE} = V_{CC}$ , and  $T_A = T_{MIN}$  to  $T_{MAX}$ , unless otherwise noted. Typical values are at  $T_A = +25^\circ C$ .)

PARAMETER	SYMBOL	CONDITIONS	MIN	TYP	MAX	UNITS
Small-Signal -3dB Bandwidth	$BW_{SS}$	$V_{OUT} = 100mV_{P-P}$		85		MHz
Large-Signal -3dB Bandwidth	$BW_{LS}$	$V_{OUT} = 2V_{P-P}$		90		MHz
Small-Signal Bandwidth for 0.1dB Gain Flatness	$BW_{0.1dBSS}$	$V_{OUT} = 100mV_{P-P}$		27		MHz
Large-Signal Bandwidth for 0.1dB Gain Flatness	$BW_{0.1dBLS}$	$V_{OUT} = 2V_{P-P}$		24		MHz
Slew Rate	SR	$V_{OUT} = 2V$ step		500		$V/\mu s$
Settling Time to 0.1%	$t_S$	$V_{OUT} = 2V$ step		21		ns
Rise/Fall Time	$t_R/t_F$	$V_{OUT} = 100mV_{P-P}$		4		ns
Spurious-Free Dynamic Range	SFDR	$f_C = 5MHz$ , $V_{OUT} = 2V_{P-P}$		-59		dBc
Differential Phase Error	DP	NTSC, $R_L = 150\Omega$		0.015		degrees
Differential Gain Error	DG	NTSC, $R_L = 150\Omega$		0.015		%
Input Noise-Voltage Density	$e_n$	$f = 10kHz$		13		$nV/\sqrt{Hz}$
Input Noise-Current Density	$i_n$	$f = 10kHz$		2.1		$pA/\sqrt{Hz}$
Input Capacitance	$C_{IN}$			1		pF
Output Impedance	$Z_{OUT}$	$f = 5MHz$		0.6		$\Omega$
Disable OFF Time		MAX4389/MAX4393/MAX4394/MAX4396		80		ns
Disable ON Time		MAX4389/MAX4393/MAX4394/MAX4396		40		ns
Channel-to-Channel Isolation	$CH_{ISO}$	MAX4392/MAX4393/MAX4394/MAX4395/ MAX4396, specified at DC		-97		dB

**Note 2:** All devices are 100% production tested at  $T_A = +25^\circ C$ . Specifications over temperature limits are guaranteed by design.

Typical Operating Characteristics

( $V_{CC} = 5V$ ,  $V_{EE} = -5V$ ,  $V_{CM} = 0V$ ,  $A_{VCL} = 1V/V$ ,  $R_L = 100\Omega$  to GND, GND = 0,  $T_A = +25^\circ C$ , unless otherwise noted.)

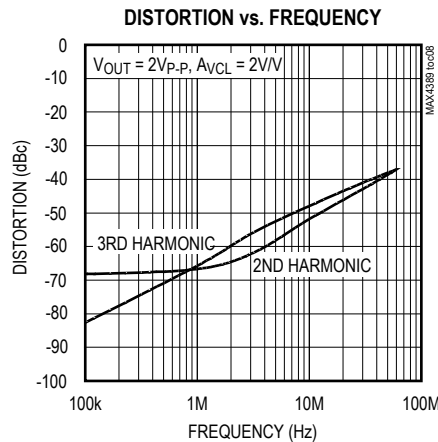

Typical Operating Characteristics (continued)

( $V_{CC} = 5V$ ,  $V_{EE} = -5V$ ,  $V_{CM} = 0V$ ,  $A_{VCL} = 1V/V$ ,  $R_L = 100\Omega$  to GND, GND = 0,  $T_A = +25^\circ C$ , unless otherwise noted.)

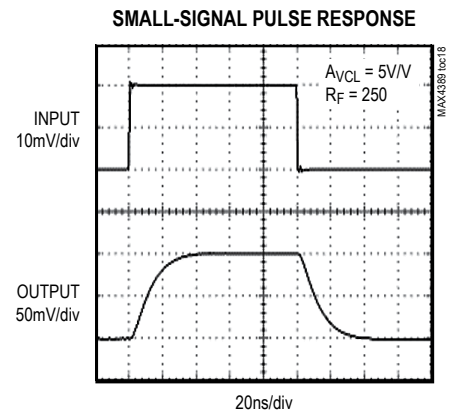
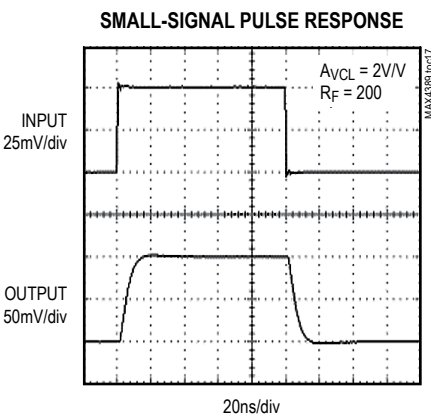
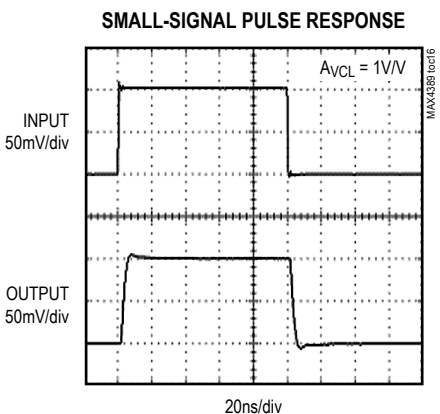
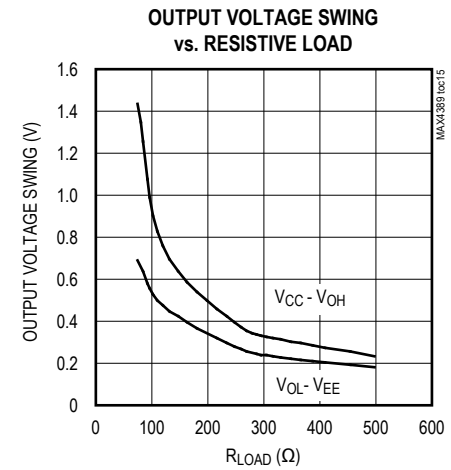
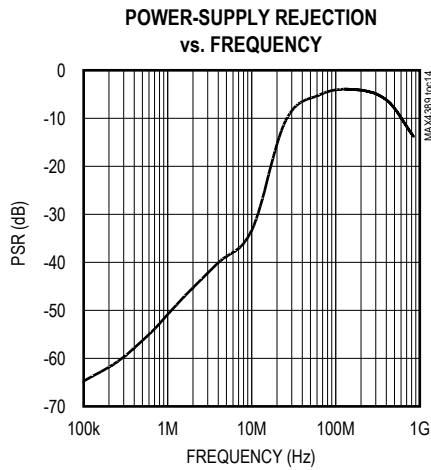
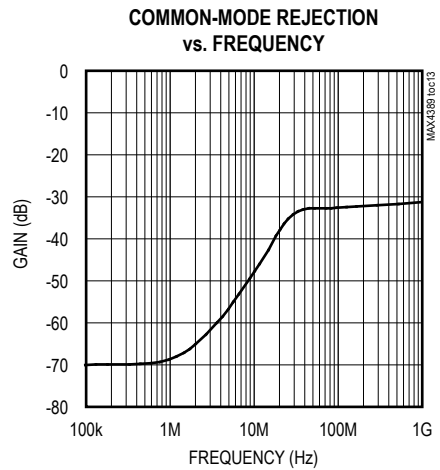
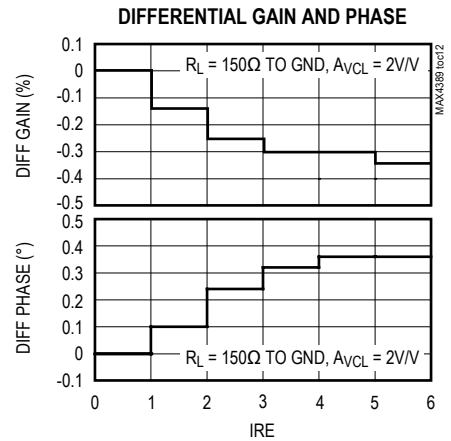
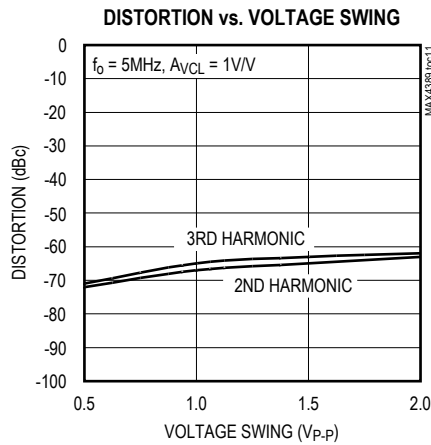
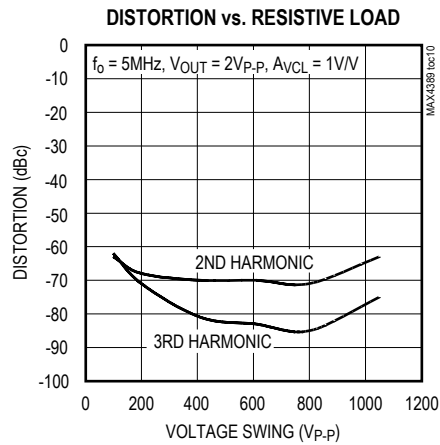

Typical Operating Characteristics (continued)

( $V_{CC} = 5V$ ,  $V_{EE} = -5V$ ,  $V_{CM} = 0V$ ,  $A_{VCL} = 1V/V$ ,  $R_L = 100\Omega$  to GND, GND = 0,  $T_A = +25^\circ C$ , unless otherwise noted.)

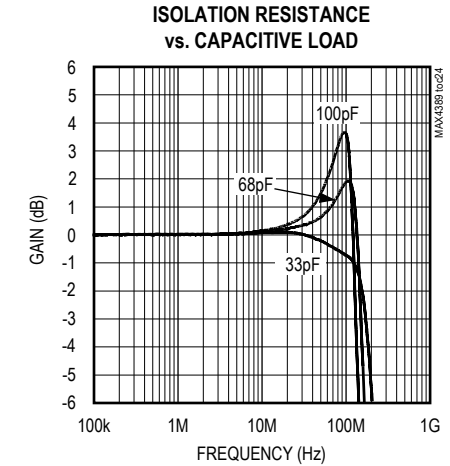
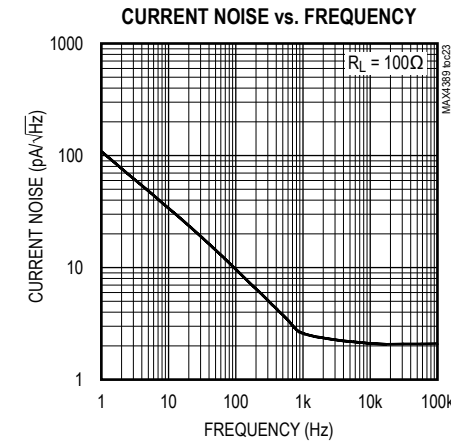
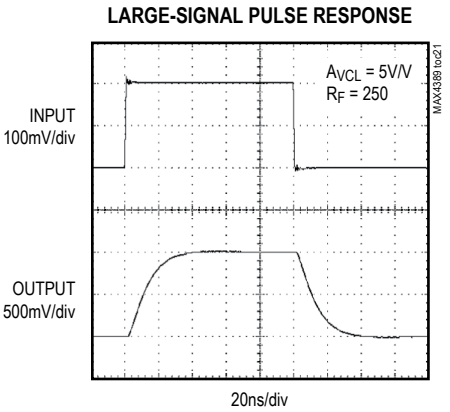
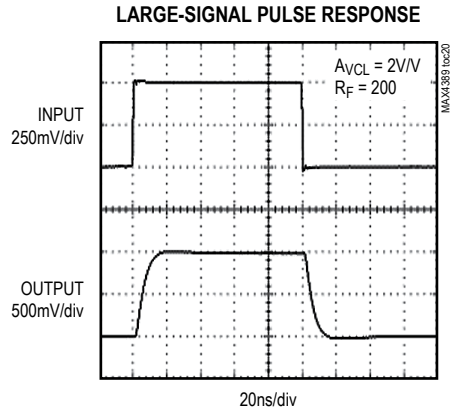
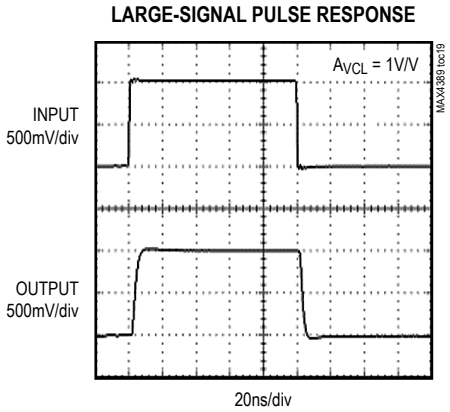



Typical Operating Characteristics (continued)

( $V_{CC} = 5V$ ,  $V_{EE} = -5V$ ,  $V_{CM} = 0V$ ,  $A_{VCL} = 1V/V$ ,  $R_L = 100\Omega$  to GND, GND = 0,  $T_A = +25^\circ C$ , unless otherwise noted.)

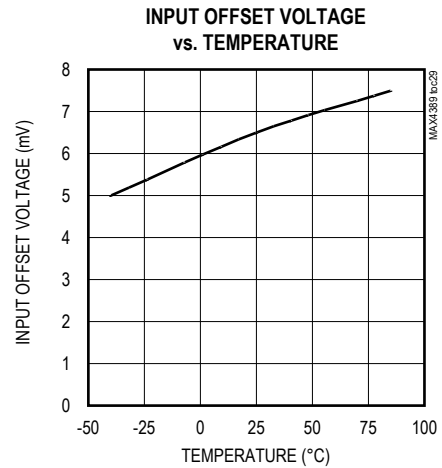
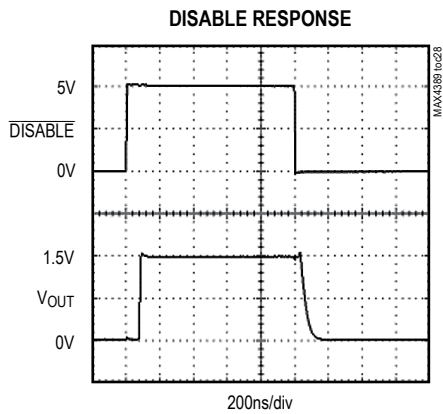
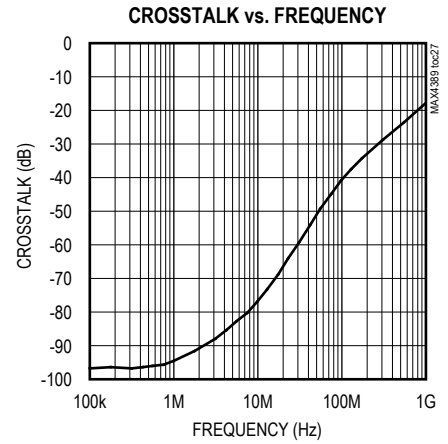
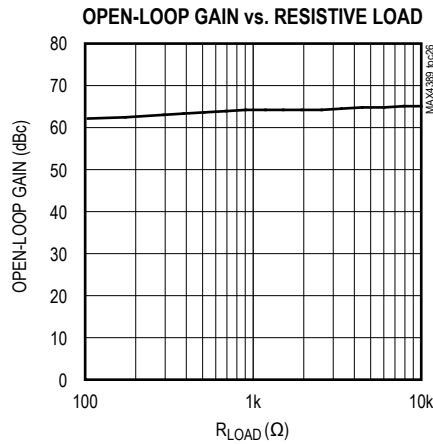
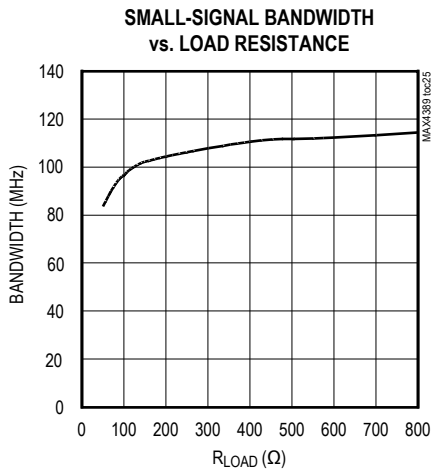

## Pin Description

PIN								NAME	FUNCTION
MAX4389	MAX4390		MAX4392	MAX4393	MAX4394	MAX4395	MAX4396		
SC70/SOT23	SC70	SOT23	μMAX/SO	μMAX	SO/TSSOP	SO/TSSOP	TSSOP		
1	1	1	—	—	—	—	—	OUT	Amplifier Output
2	2	2	4	4	11	11	16	V <sub>EE</sub>	Negative Power Supply. Connect a 0.1μF capacitor to GND.
3	3	3	—	—	—	—	—	IN+	Noninverting Input
4	4	4	—	—	—	—	—	IN-	Inverting Input
5	—	—	—	—	—	—	—	$\overline{\text{DISABLE}}$	Disable. Connect to V <sub>CC</sub> to enable.
6	6	5	8	10	4	4	5	V <sub>CC</sub>	Positive Power Supply. Connect a 0.1μF capacitor to GND.
—	5	—	—	—	—	—	10, 11	N.C.	No Connection. Not internally connected.
—	—	—	3	3	5	3	4	INA+	Amplifier A Noninverting Input
—	—	—	2	2	6	2	3	INA-	Amplifier A Inverting Input
—	—	—	1	1	7	1	2	OUTA	Amplifier A Output
—	—	—	—	5	1	—	1	$\overline{\text{DISABLEA}}$	Shutdown Amplifier A. Connect to V <sub>CC</sub> to enable.
—	—	—	5	7	10	5	6	INB+	Amplifier B Noninverting Input
—	—	—	6	8	9	6	7	INB-	Amplifier B Inverting Input
—	—	—	7	9	8	7	8	OUTB	Amplifier B Output

### Pin Description (continued)

PIN								NAME	FUNCTION
MAX4389	MAX4390		MAX4392	MAX4393	MAX4394	MAX4395	MAX4396		
SC70/SOT23	SC70	SOT23	μMAX/SO	μMAX	SO/TSSOP	SO/TSSOP	TSSOP		
—	—	—	—	6	3	—	9	$\overline{\text{DISABLEB}}$	Shutdown Amplifier B. Connect to $V_{CC}$ to enable.
—	—	—	—	—	12	10	15	INC+	Amplifier C Noninverting Input
—	—	—	—	—	13	9	14	INC-	Amplifier C Inverting Input
—	—	—	—	—	14	8	13	OUTC	Amplifier C Output
—	—	—	—	—	2	—	12	$\overline{\text{DISABLEC}}$	Shutdown Amplifier C. Connect to $V_{CC}$ to enable.
—	—	—	—	—	—	12	17	IND+	Amplifier D Noninverting Input
—	—	—	—	—	—	13	18	IND-	Amplifier D Inverting Input
—	—	—	—	—	—	14	19	OUTD	Amplifier D Output
—	—	—	—	—	—	—	20	$\overline{\text{DISABLED}}$	Shutdown Amplifier D. Connect to $V_{CC}$ to enable.

### Detailed Description

The MAX4389/MAX4390/MAX4392–MAX4396 are dual-supply, rail-to-rail, voltage-feedback amplifiers that employ current-feedback techniques to achieve 500V/μs slew rates and 85MHz bandwidths. Excellent harmonic distortion and differential gain/phase performance make these amplifiers an ideal choice for a wide variety of video and RF signal-processing applications.

### Applications Information

The output voltage swings to within 200mV of each supply rail. Local feedback around the output stage ensures low open-loop output impedance to reduce gain sensitivity to

load variations. The input stage permits common-mode voltages to the negative supply and to within 2.25V of the positive supply rail.

### Choosing Resistor Values

#### Unity-Gain Configuration

The MAX4389/MAX4390/MAX4392–MAX4396 are internally compensated for unity gain. When configured for unity gain, a 24Ω resistor ( $R_F$ ) in series with the feedback path optimizes AC performance. This resistor improves AC response by reducing the Q of the parallel LC circuit formed by the parasitic feedback capacitance and inductance.

### Video Line Driver

The MAX4389/MAX4390/MAX4392–MAX4396 are low-power, voltage-feedback amplifiers featuring large-signal ( $2V_{P-P}$ ) bandwidths of 90MHz and 0.1dB large-signal gain flatness of 24MHz. They are designed to minimize differential-gain error and differential-phase error to 0.015% and  $0.015^\circ$ , respectively. They have a 21ns settling time to 0.1%, 500V/ $\mu$ s slew rates, and output-current-drive capability of up to 50mA making them ideal for driving video loads.

### Inverting and Noninverting Configurations

Select the gain-setting feedback ( $R_F$ ) and input ( $R_G$ ) resistor values to fit your application. Large resistor values increase voltage noise and interact with the amplifier's input and PCB capacitance. This can generate undesirable poles and zeros and decrease bandwidth or cause oscillations. For example, a noninverting gain-of-two configuration ( $R_F = R_G$ ) using 2k $\Omega$  resistors, combined with 1pF of amplifier input capacitance and 1pF of PCB capacitance, causes a pole at 79.6MHz. Since this pole is within the amplifier bandwidth, it jeopardizes stability. Reducing the 2k $\Omega$  resistors to 100 $\Omega$  extends the pole frequency to 1.59GHz, but could limit output swing by adding 200 $\Omega$  in parallel with the amplifier's load resistor (Figures 1a and 1b).



Figure 1a. Noninverting Gain Configuration



Figure 1b. Inverting Gain Configuration

### Layout and Power-Supply Bypassing

The MAX4389/MAX4390/MAX4392–MAX4396 operate from single 4.5V to 11V or from dual  $\pm 2.25V$  to  $\pm 5.5V$  supplies. Bypass each supply with a 0.1 $\mu$ F capacitor as close to the pin as possible.

Maxim recommends using microstrip and stripline techniques to obtain full bandwidth. To ensure that the PCB does not degrade the amplifier's performance, design it for a frequency greater than 1GHz. Pay careful attention to inputs and outputs to avoid large parasitic capacitance. Whether or not you use a constant-impedance board, observe the following design guidelines:

- Do not use wire-wrap boards; they are too inductive.
- Do not use IC sockets; they increase parasitic capacitance and inductance.
- Use surface-mount instead of through-hole components for better, high-frequency performance.
- Use a PCB with at least two layers; it should be as free from voids as possible.
- Keep signal lines as short and as straight as possible. Do not make  $90^\circ$  turns; round all corners.

### Low-Power Disable Mode

The MAX4389/MAX4393/MAX4394/MAX4396 feature a disable function that allows the amplifiers to be placed in a low-power, high-output impedance state. When the disable pin ( $\overline{\text{DISABLE}}$ ) is active, the amplifier's output impedance is 95k $\Omega$ . This high resistance and the low 2pF output capacitance make the MAX4389/MAX4390/MAX4392–MAX4396 in RF/video multiplexer or switch applications. For larger arrays, pay careful attention to capacitive loading (see the *Output Capacitive Loading and Stability* section).

### Output Capacitive Loading and Stability

The MAX4389/MAX4390/MAX4392–MAX4396 are optimized for AC performance. They are not designed to drive highly reactive loads, which decrease phase margin and may produce excessive ringing and oscillation. Figure 2 shows a circuit that eliminates this problem. Figure 3 is a graph of the Optimal Isolation Resistor ( $R_S$ ) vs. Capacitive Load. Figure 4 shows how a capacitive load causes excessive peaking of the amplifier's frequency response if the capacitor is not isolated from the amplifier by a resistor. A small isolation resistor (usually 10 $\Omega$  to 15 $\Omega$ ) placed before the reactive load prevents ringing and oscillation. At higher capacitive loads, AC performance is controlled by the interaction of the load capacitance and the isolation resistor. Figure 5 shows the effect of a 15 $\Omega$  isolation resistor on closed-loop response.

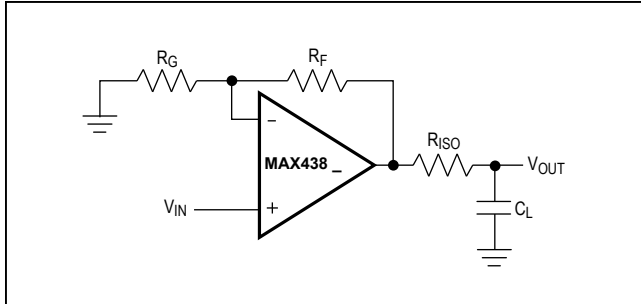

Figure 2. Driving a Capacitive Load Through an Isolation Resistor

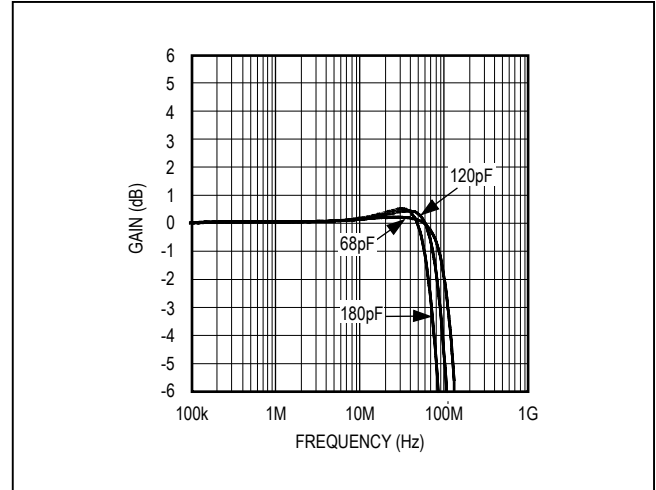

Figure 5. Small-Signal Gain vs. Frequency with Load Capacitance and 27Ω Isolation Resistor

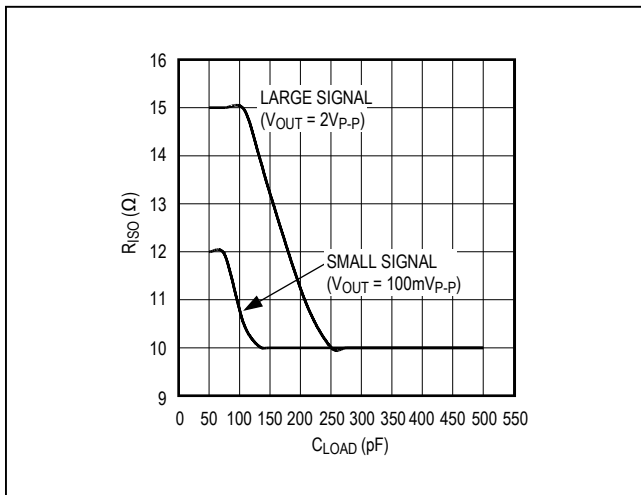

Figure 3. Isolation Resistance vs. Capacitive Load

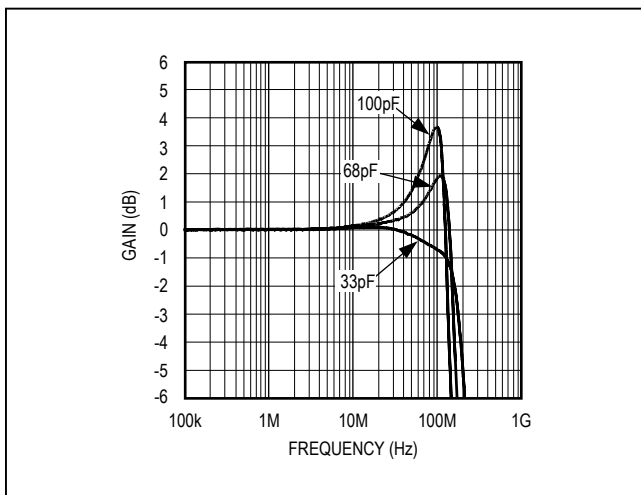
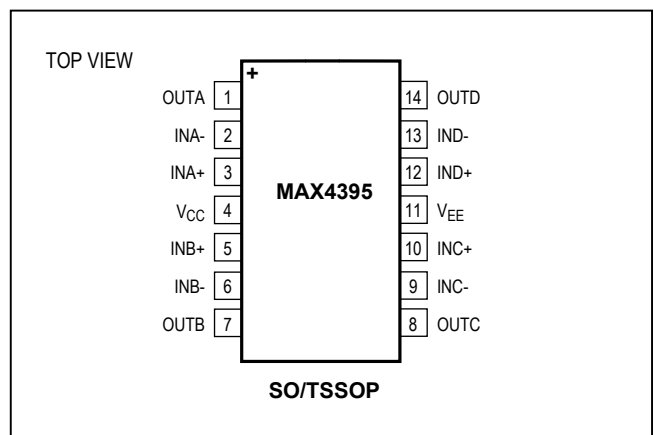
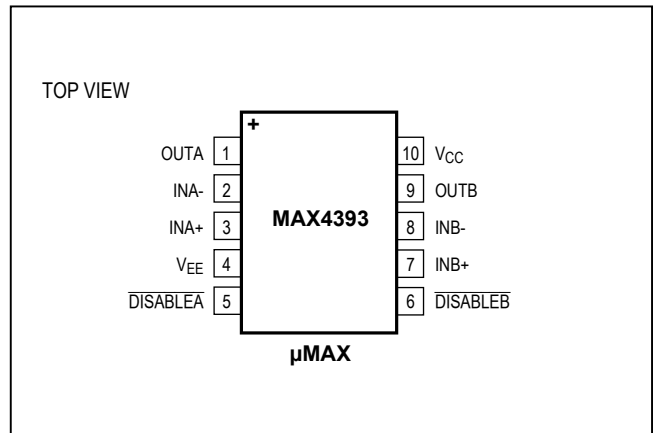
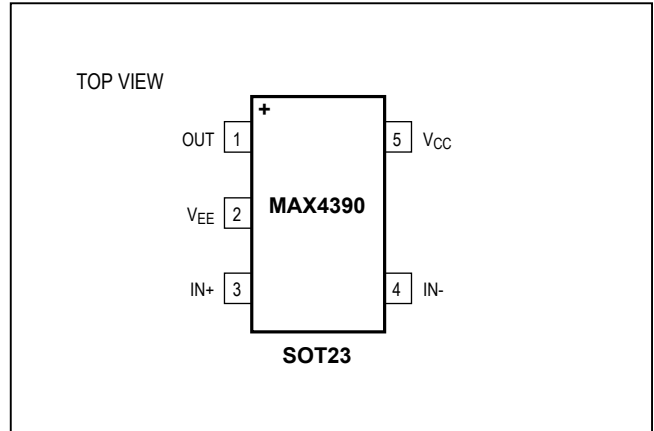

Figure 4. Small-Signal Gain vs. Frequency with Load Capacitance and No Isolation Resistor

### Chip Information

PROCESS: BiCMOS

Pin Configurations (continued)



### Pin Configurations (continued)

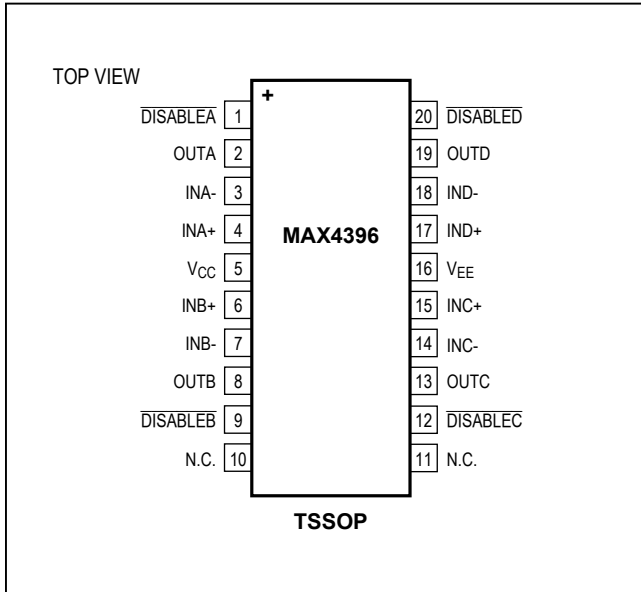

### Ordering Information (continued)

PART	TEMP RANGE	PIN-PACKAGE	TOP MARK
<b>MAX4392</b> ESA+T	-40°C to +85°C	8 SO	—
MAX4392EUA+T	-40°C to +85°C	8 μMAX	—
<b>MAX4393</b> EUB+T	-40°C to +85°C	10 μMAX	—
<b>MAX4394</b> ESD+T	-40°C to +85°C	14 SO	—
MAX4394EUD+T	-40°C to +85°C	14 TSSOP	—
<b>MAX4395</b> ESD+T	-40°C to +85°C	14 SO	—
MAX4395EUD+T	-40°C to +85°C	14 TSSOP	—
<b>MAX4396</b> EUP+T	-40°C to +85°C	20 TSSOP	—

+Denotes a lead(Pb)-free/RoHs-compliant package.

/V denotes an automotive qualified part.

T = Tape and reel.

### Selector Guide

PART	NO. OF AMPS	DISABLE
MAX4389	1	Yes
MAX4390	1	No
MAX4392	2	No
MAX4393	2	Yes
MAX4394	3	Yes
MAX4395	4	No
MAX4396	4	Yes

## Package Information

For the latest package outline information and land patterns (footprints), go to [www.maximintegrated.com/packages](http://www.maximintegrated.com/packages). Note that a "+", "#", or "-" in the package code indicates RoHS status only. Package drawings may show a different suffix character, but the drawing pertains to the package regardless of RoHS status.

PACKAGE TYPE	PACKAGE CODE	OUTLINE NO.	LAND PATTERN NO.
6 SC70	X6SN+1	<a href="#">21-0077</a>	<a href="#">90-0189</a>
6 SOT23	U6SN+1	<a href="#">21-0058</a>	<a href="#">90-0175</a>
5 SOT23	U5+1	<a href="#">21-0057</a>	<a href="#">90-0174</a>
8 $\mu$ MAX	U8+1	<a href="#">21-0036</a>	<a href="#">90-0092</a>
10 $\mu$ MAX	U10+2	<a href="#">21-0061</a>	<a href="#">90-0330</a>
8 SO	S8+2	<a href="#">21-0041</a>	<a href="#">90-0096</a>
14 SO	S14+1	<a href="#">21-0041</a>	<a href="#">90-0112</a>
14 TSSOP	U14+1	<a href="#">21-0066</a>	<a href="#">90-0113</a>
20 TSSOP	U20+3	<a href="#">21-0066</a>	<a href="#">90-0116</a>



## Revision History

REVISION NUMBER	REVISION DATE	DESCRIPTION	PAGES CHANGED
4	11/09	Added automotive qualified parts	2, 15
5	5/14	Revised package codes	16
6	4/15	Removed automotive packages from data sheet	1, 15

For pricing, delivery, and ordering information, please contact Maxim Direct at 1-888-629-4642, or visit Maxim Integrated's website at [www.maximintegrated.com](http://www.maximintegrated.com).

*Maxim Integrated cannot assume responsibility for use of any circuitry other than circuitry entirely embodied in a Maxim Integrated product. No circuit patent licenses are implied. Maxim Integrated reserves the right to change the circuitry and specifications without notice at any time. The parametric values (min and max limits) shown in the Electrical Characteristics table are guaranteed. Other parametric values quoted in this data sheet are provided for guidance.*



Компания «ЭлектроПласт» предлагает заключение долгосрочных отношений при поставках импортных электронных компонентов на взаимовыгодных условиях!

Наши преимущества:

- Оперативные поставки широкого спектра электронных компонентов отечественного и импортного производства напрямую от производителей и с крупнейших мировых складов;
- Поставка более 17-ти миллионов наименований электронных компонентов;
- Поставка сложных, дефицитных, либо снятых с производства позиций;
- Оперативные сроки поставки под заказ (от 5 рабочих дней);
- Экспресс доставка в любую точку России;
- Техническая поддержка проекта, помощь в подборе аналогов, поставка прототипов;
- Система менеджмента качества сертифицирована по Международному стандарту ISO 9001;
- Лицензия ФСБ на осуществление работ с использованием сведений, составляющих государственную тайну;
- Поставка специализированных компонентов (Xilinx, Altera, Analog Devices, Intersil, Interpoint, Microsemi, Aeroflex, Peregrine, Syfer, Eurofarad, Texas Instrument, Miteq, Cobham, E2V, MA-COM, Hittite, Mini-Circuits, General Dynamics и др.);

Помимо этого, одним из направлений компании «ЭлектроПласт» является направление «Источники питания». Мы предлагаем Вам помощь Конструкторского отдела:

- Подбор оптимального решения, техническое обоснование при выборе компонента;
- Подбор аналогов;
- Консультации по применению компонента;
- Поставка образцов и прототипов;
- Техническая поддержка проекта;
- Защита от снятия компонента с производства.



#### Как с нами связаться

**Телефон:** 8 (812) 309 58 32 (многоканальный)

**Факс:** 8 (812) 320-02-42

**Электронная почта:** [org@eplast1.ru](mailto:org@eplast1.ru)

**Адрес:** 198099, г. Санкт-Петербург, ул. Калинина, дом 2, корпус 4, литера А.