

# H-Series Circuit Breaker

The H-Series hydraulic/magnetic circuit breaker provides dependable circuit protection in a low cost, compact package. By meeting the IEC spacing requirements, the H-Series is the ideal choice for international market applications. It also features a "trip-free" mechanism, which will open the contacts when a fault condition occurs, even if the handle is held in the ON position. Although a low cost option, the H-Series was designed for maximum performance and reliable equipment protection meeting Carling's stringent quality standards.

#### Key Features & Benefits:

- Choice of actuator styles
- UL1077, CCC, CSA, C22.2 and EN60934 approvals
- Compact size
- Temperature stable operation -40°C to 80°C
- Choice of terminals, including PCB
- Single or multi-pole configurations



CURVED ROCKER ACTUATOR



HANDLE ACTUATOR



FLAT WITH PUSH-TO-RESET ACTUATOR



CURVED ROCKER WITH GUARD



**Carling Technologies®**

Innovative Designs. Powerful Solutions.

Innovative Designs. Powerful Solutions.

**Product Bulletin #139**  
**January 2012**

Carling Technologies, Inc.

60 Johnson Avenue • Plainville, CT 06062-1177

Phone: (860) 793-9281 • Fax: (860) 793-9231

Email: [sales@carlingtech.com](mailto:sales@carlingtech.com) • [www.carlingtech.com](http://www.carlingtech.com)

## Electrical Tables

**Table A:** Lists UL Recognized, CSA Accepted and TUV Certified configurations and performance capabilities as a Component Supplementary Protector.

H SERIES - COMPONENT SUPPLEMENTARY PROTECTOR										
CIRCUIT CONFIGURATION	VOLTAGE			CURRENT		SHORT CIRCUIT CAPACITY (AMPS)			APPLICATION CODES	
	MAX RATING	FREQ.	PHASE	FULL LOAD	MINIMUM POLES	UL WITHOUT BACKUP FUSE	CSA WITHOUT BACKUP FUSE	TUV WITHOUT BACKUP FUSE	UL	CSA
	SERIES	65	DC	--	1 - 32	1	3000	3000	1500(PC1)	TC1, OL1, U1
65		DC	--	1 - 32	1	---	500	---	---	TC1, OL1, U3
80		DC	--	1 - 25	1	1000	800	1000(PC1)	TC1, OL1, U1	TC1, OL1, U1
80 <sup>1</sup>		DC	--	26 - 32	1	1000	1000	1000(PC1)	TC1, OL1, U3	TC1, OL1, U3
250		50/60	1	1 - 32	1	1500	1500	1000(PC1)	TC1, OL1, U1	TC1, OL1, U1
250		50/60	1	1 - 32	2	1500	1500	1000(PC1)	TC1, OL1, U3	TC1, OL1, U3
250		50/60	3	1 - 32	3	1500	1500	1000(PC1)	TC1, OL0, U3	TC1, OL0, U3

1 - Polarity Sensitive

## Electrical

Maximum Voltage 250VAC 50/60Hz 80 VDC  
 Current Rating Standard current coils: 1.00, 2.50, 5.00, 7.50, 10.0, 15.0, 20.0, 25.0, 30.0, 32.0  
 Auxiliary Switch Rating SPDT: 10.1A-250VAC, 1.0A-65VDC/0.5A-80VDC, 0.1A-125VAC (with gold contacts)

## Mechanical

Endurance 10,000 ON-OFF operations @ 6 per minute; with rated current & voltage

## Physical

Number of Poles 1-3  
 Weight Approx. 48 grams/pole (1.7 oz)  
 Internal Circuit Config. Series and Switch Only (with or without auxiliary switch)

## Agency Approvals

UL Recognized under the Component Recognition Program as Protectors, Supplementary (Guide QVNU2 File E75596)  
 UL standard 1077

CCC certified, Certificate No. 2010010307447291

CSA Accepted Circuit Breaker, CSA standard C22.2 No. 235

TUV certified to EN60934, Certificate No. R50204086

## Typical Protector Resistance

DCR and Impedance values are based on measurements by the voltmeter ammeter method. Rated current is applied for one hour and at a voltage not less than 20 volts. Ambient temperature: 25 °C; Tolerance: Below 10 amps +/- 25%; Above 10 amps +/-35%

## Impedance Chart

Current rating in amperes	Series	
	DC-Ohms	50/60Hz-Ohms
1	0.85	0.87
2.5	0.13	0.15
5	0.035	0.036
7.5	0.018	0.019
10	0.01	0.011
15	0.006	0.0061
20	0.005	0.0051
25	0.003	0.0035
30	0.0025	0.0026

\*Manufacturer reserves the right to change product specification without prior notice.

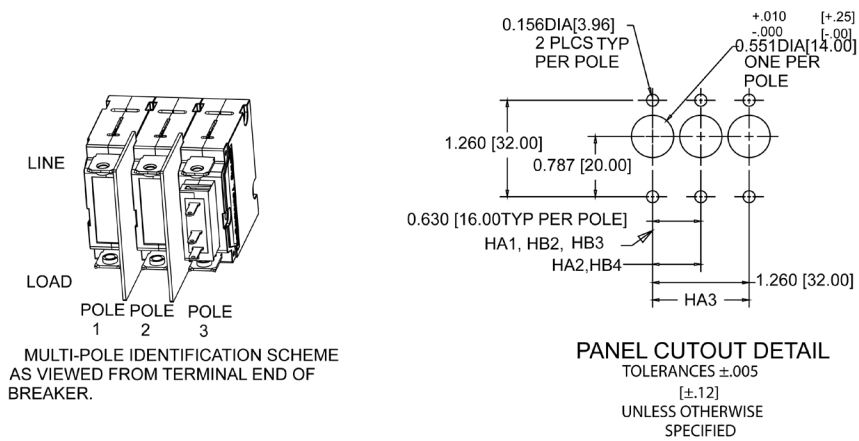
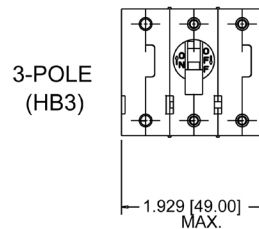
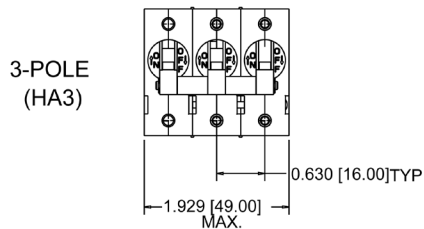
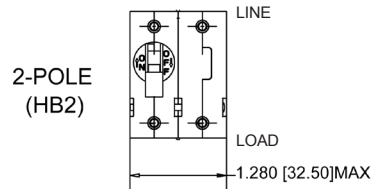
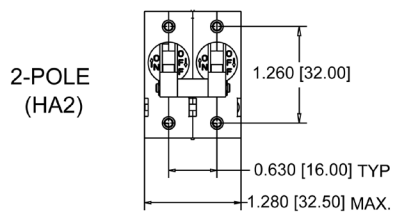
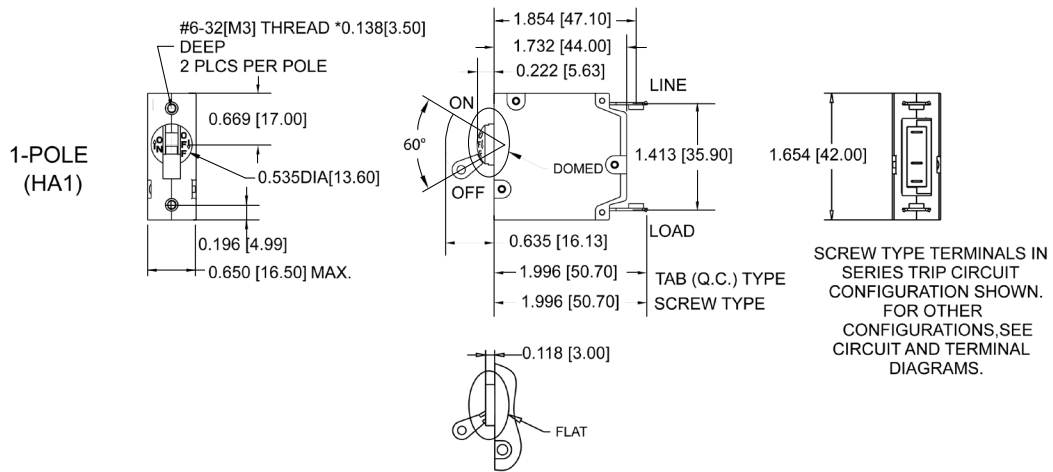

MULTI-POLE IDENTIFICATION SCHEME AS VIEWED FROM TERMINAL END OF BREAKER.

1. ALL DIMENSIONS ARE IN INCHES [millimeters].
2. TOLERANCE ±.020 [51] UNLESS OTHERWISE SPECIFIED.

# 4 | H-Series – Dimensional Specifications: in. [mm] – Curved Rocker Actuator

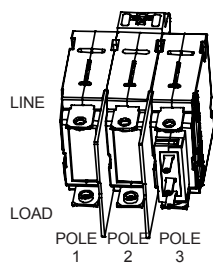
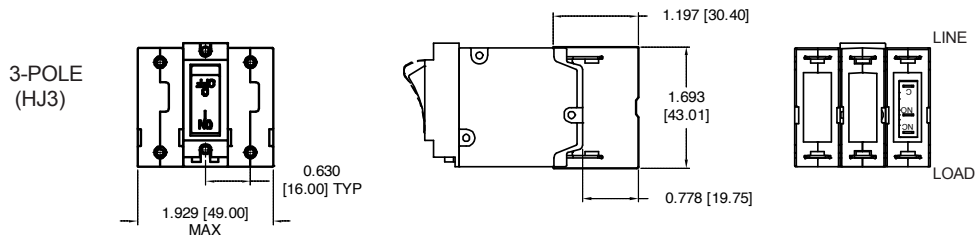
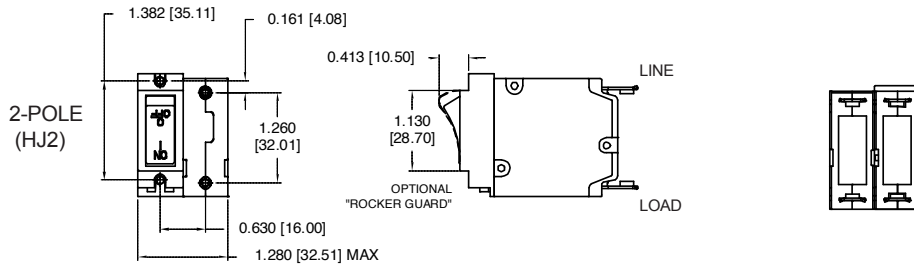
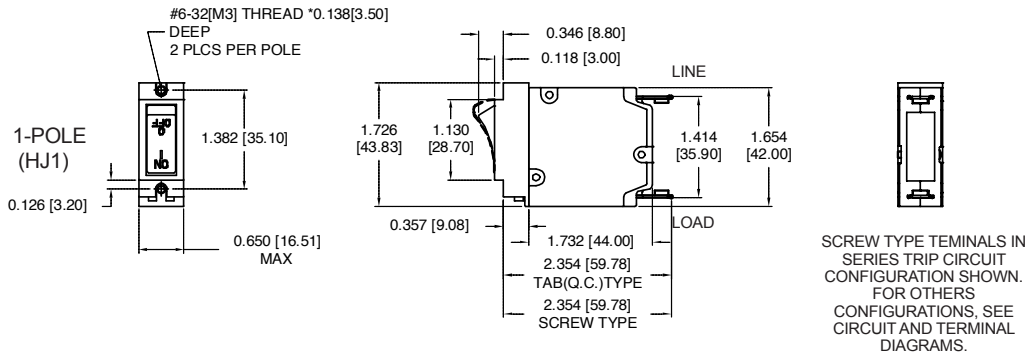

MULTI-POLE IDENTIFICATION SCHEME AS VIEWED FROM TERMINAL END OF BREAKER.

- NOTES:
1. ALL DIMENSIONS ARE IN INCHES [mm]
  2. TOLERANCE  $\pm 0.020$  [.51] UNLESS OTHERWISE SPECIFIED.

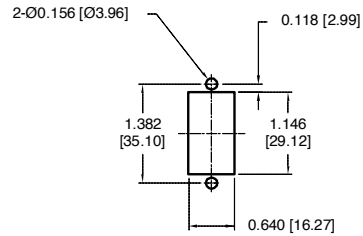

PANEL CUTOUT DETAIL  
TOLERANCE  $\pm 0.005$  [±.12]  
UNLESS OTHERWISE SPECIFIED

PUSH-TO-RESET ACTUATOR

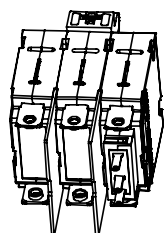
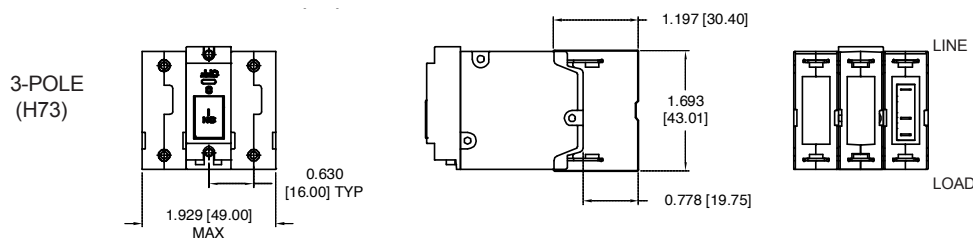
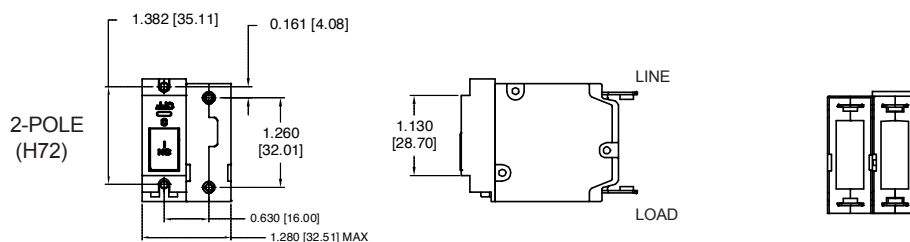
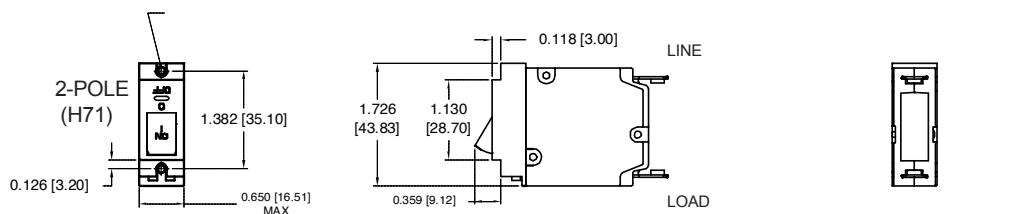
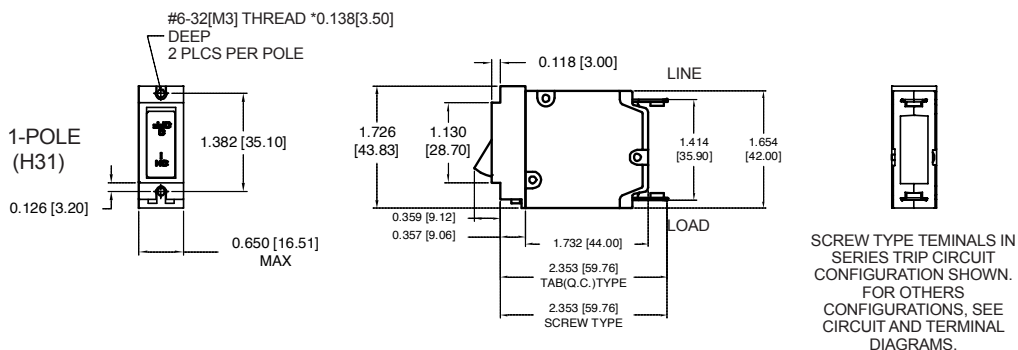

MULTI-POLE IDENTIFICATION SCHEME AS VIEWED FROM TERMINAL END OF BREAKER.

- NOTES:
1. ALL DIMENSIONS ARE IN INCHES [mm]
  2. TOLERANCE  $\pm 0.020$  [51] UNLESS OTHERWISE SPECIFIED.

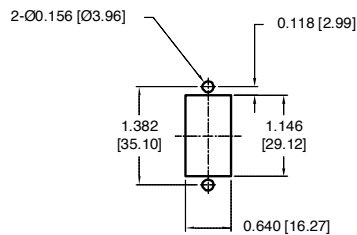

PANEL CUTOUT DETAIL TOLERANCE  $\pm 0.005$  [±.12] UNLESS OTHERWISE SPECIFIED

PRINTED CIRCUIT BOARD MOUNTING  
TERMINAL CODE R

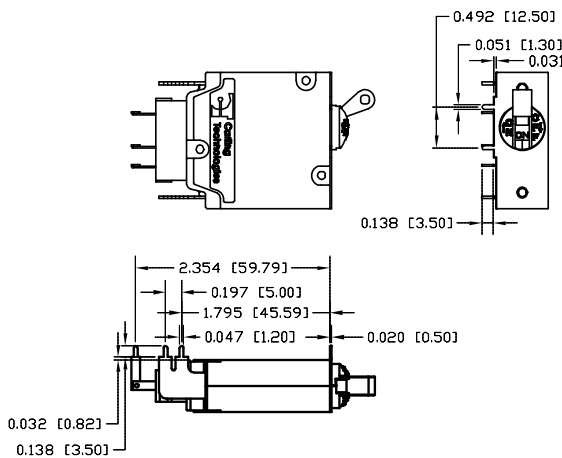

PRINTED CIRCUIT BOARD MOUNTING  
TERMINAL CODE L

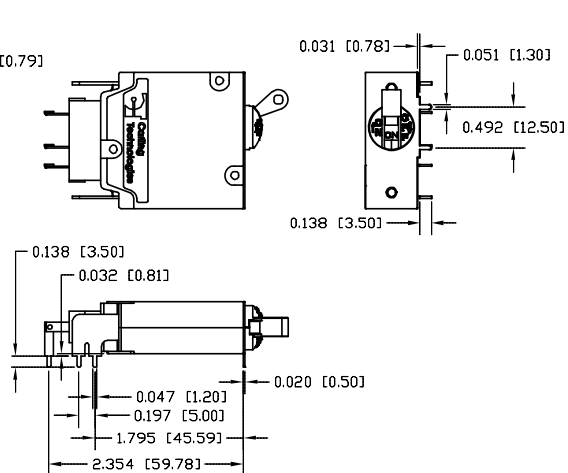

PRINTED CIRCUIT BOARD MOUNTING  
TERMINAL CODE S & T

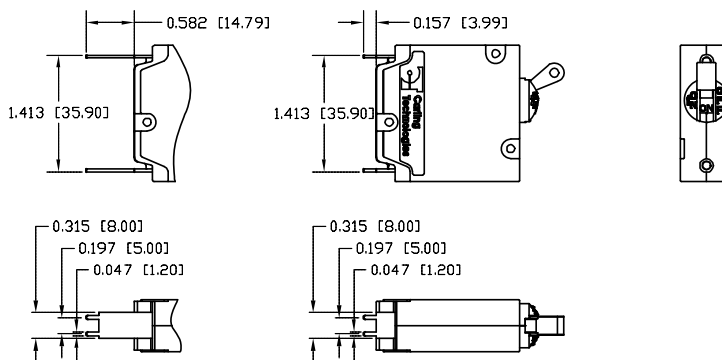

NOTES:  
1. ALL DIMENSIONS ARE IN INCHES [mm]  
2. TOLERANCE  $\pm 0.020$  [51] UNLESS OTHERWISE SPECIFIED.

P.C. FOOT PRINT  
FOR TERMINAL CODE R

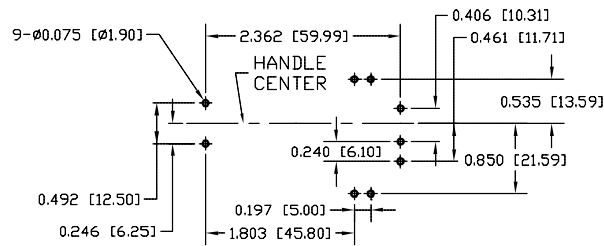

P.C. FOOT PRINT  
FOR TERMINAL CODE L

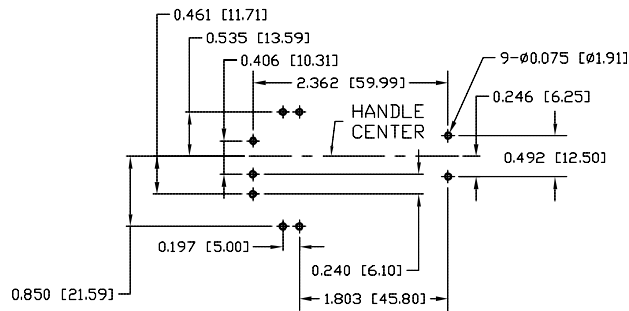

P.C. FOOT PRINT  
FOR TERMINAL CODE S & T

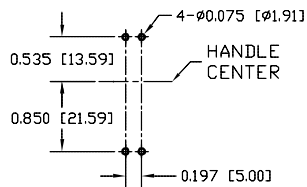

- NOTES:  
1. ALL DIMENSIONS ARE IN INCHES [mm]  
2. TOLERANCE  $\pm 0.020$  [.51] UNLESS OTHERWISE SPECIFIED.

HANDLE POSITION VS. AUX SWITCH MODE		
STANDARD C/B		
CIRCUIT BREAKER MODE	HANDLE POSITION	AUX. SWITCH MODE
OFF		
ON		
ELECTRICAL TRIP		

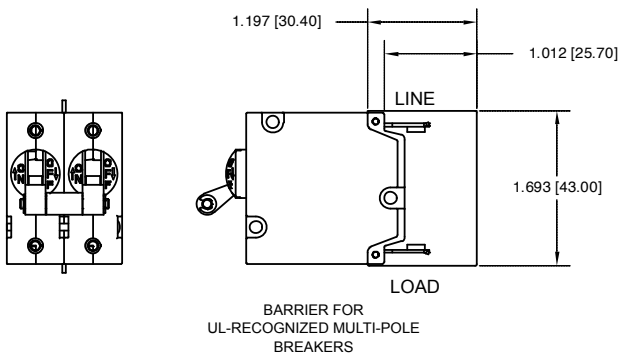
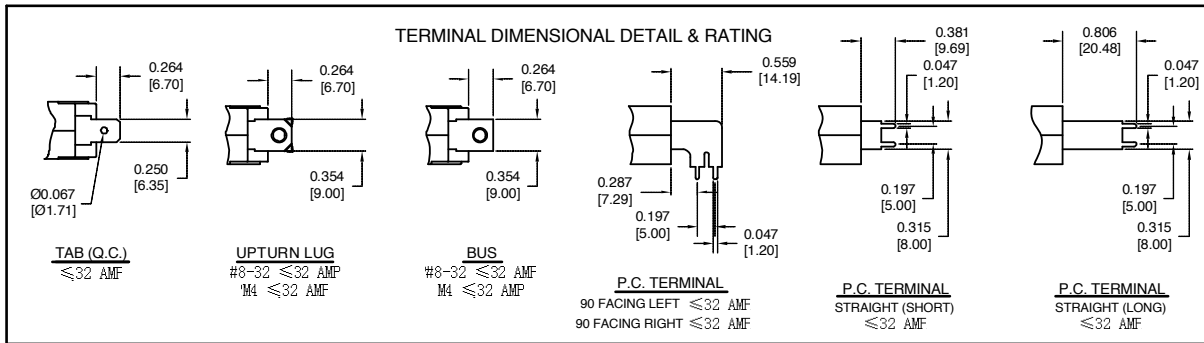
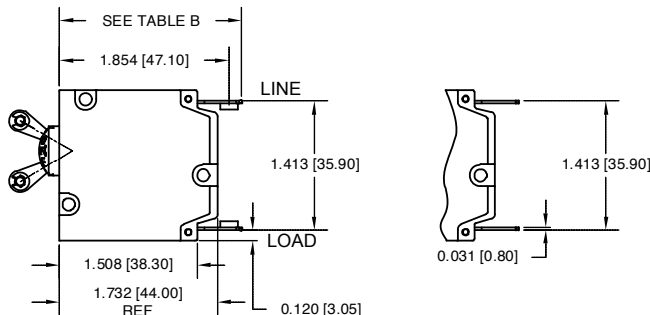

**TABLE A  
TIGHTENING TORQUE SPECIFICATIONS**

THREAD SIZE	TORQUE
#6-32 & M3 MOUNTING HARDWARE	7-9 IN-LBS [0.8-1.0 NM]
#8-32 & M4 THREAD TERMINAL SCREW	12-15 IN-LBS [1.4-1.7 NM]

**TABLE B**

TERMINAL DESCRIPTION		DEPTH BEHIND PANEL
MAIN	TAB (Q.C.)	1.996 [50.70]
	SCREW TYPE	1.996 [50.70]
AUX. SWITCH*	.110 TAB (Q.C.)	2.467 [62.67]
	SOLDER TYPE	2.252 [57.19]



\* AVAILABLE ON SERIES TRIP AND SWITCH ONLY CIRCUITS. WHEN CALLED FOR ON MULTI-POLE UNITS, ONLY ONE AUX. SWITCH IS NORMALLY SUPPLIED, AS SHOWN IN MULTI-POLE IDENTIFICATION SCHEME.

1. ALL DIMENSIONS ARE IN INCHES [mm]  
2. TOLERANCE ±.020 [.51] UNLESS OTHERWISE SPECIFIED.



CIRCUIT BREAKER PROFILE	CIRCUIT SCHEMATIC		CIRCUIT CODE	AUX SWITCH CODE	CIRCUIT SCHEMATIC		CIRCUIT CODE	AUX SWITCH CODE
	ANSI	SWITCH ONLY (NO COIL)			ANSI	SERIES TRIP		
<b>2 TERMINALS</b> 			A	0	B,C	0		
<b>5 TERMINALS</b> 	<b>SWITCH ONLY (NO COIL) WITH AUXILIARY SWITCH</b> 	<b>SERIES TRIP WITH AUXILIARY</b> 	A	1 2 3	B,C	1 2 3		
<b>4 TERMINALS</b> 	<b>RELAY TRIP</b> 		G	0				

**AUXILIARY SWITCH TERMINAL DETAIL**

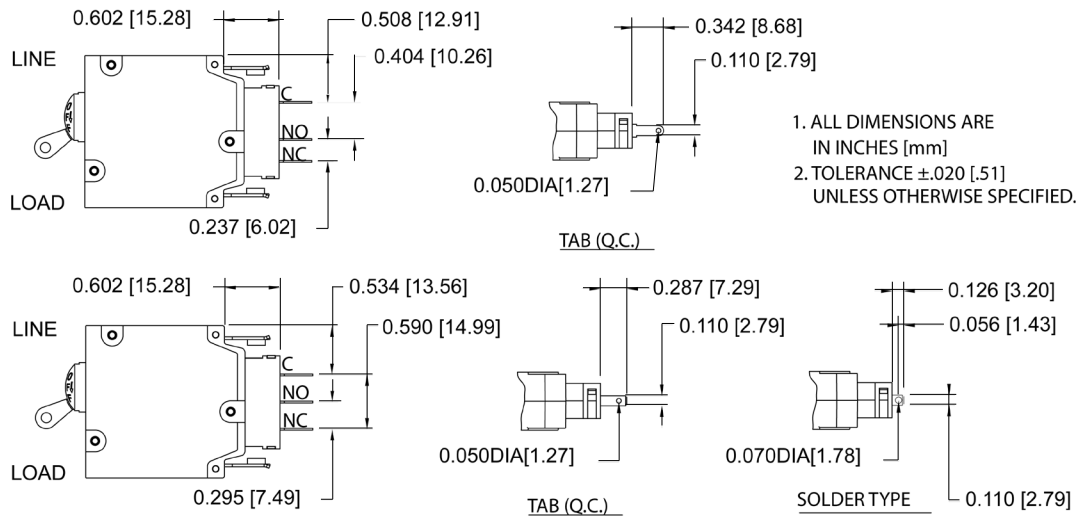

TRIP TIME (SECONDS)	PERCENT OF RATED CURRENT										
	DELAY	100%	125%	135%	150%	200%	400%	600%	800%	1000%	1200%
10	No Trip	May Trip	---	.032 MAX	.024 MAX	.020 MAX	.018 MAX	.016 MAX	.015 MAX	.013 MAX	
11	No Trip	.013 - .125	---	.010 - .070	.008 - .032	.006 - .020	.005 - .020	.004 - .020	.004 - .020	.004 - .020	
12	No Trip	.500 - 6.50	---	.300 - 3.00	.130 - 1.20	.031 - .220	.011 - .120	.004 - .090	.004 - .060	.004 - .040	
14	No Trip	2.00 - 60.0	---	1.20 - 40.0	.600 - 20.0	.150 - 3.00	.030 - 1.30	.004 - .600	.004 - .100	.004 - .100	
16	No Trip	45.0 - 345	---	20.0 - 150	9.00 - 60.0	1.40 - 11.4	.150 - 5.80	.009 - 3.70	.005 - 1.70	.005 - 1.50	
20	No Trip	May Trip	---	.040 MAX	.035 MAX	.030 MAX	.025 MAX	.020 MAX	.017 MAX	.015 MAX	
21	No Trip	.014 - .150	---	.011 - .095	.008 - .055	.006 - .035	.005 - .027	.005 - .021	.004 - .018	.004 - .017	
22	No Trip	.700 - 12.0	---	.350 - 4.00	.130 - 1.30	.027 - .220	.008 - .130	.004 - .090	.004 - .045	.004 - .040	
24	No Trip	10.0 - 160	---	6.00 - 60.0	2.20 - 20.0	.300 - 3.00	.050 - 1.30	.007 - .500	.005 - .060	.005 - .040	
26	No Trip	50.0 - 700	---	32.0 - 350	10.0 - 90.0	1.50 - 15.0	.500 - 7.00	.020 - 3.00	.006 - 2.00	.005 - 1.00	
42	No Trip	.700 - 12.0	---	.400 - 6.00	.180 - 2.30	.050 - 6.00	.026 - .300	.018 - .200	.014 - .150	.012 - .130	
44	No Trip	7.00 - 100	---	3.00 - 50.0	1.10 - 18.0	.220 - 3.00	.120 - 1.70	.075 - 1.20	.050 - .850	.042 - .720	
46	No Trip	50.0 - 700	---	31.0 - 350	12.0 - 150	1.50 - 20.0	.700 - 10.0	.404 - 7.90	.260 - 6.50	.198 - 5.80	
52	No Trip	.500 - 6.50	---	.340 - 4.50	.180 - 2.30	.051 - .600	.030 - .320	.018 - .220	.014 - .200	.012 - .130	
54	No Trip	1.50 - 50.0	---	.750 - 35.0	.350 - 18.0	.110 - 3.00	.070 - 1.70	.045 - 1.40	.039 - 1.30	.035 - 1.30	
56	No Trip	45.0 - 345	---	19.0 - 170	8.50 - 100	1.24 - 15.0	.410 - 9.00	.256 - 8.00	.210 - 5.50	.198 - 2.90	

NOTES:  
 Delay Curves 11,12,14,16,21,22,24,26: Breakers to hold 100% and must trip at 125% of rated current and greater within the time limit shown in this curve.  
 Delay Curves 10,20: Breakers to hold 100% and must trip at 150% of rated current and greater within the time limit shown in this curve.  
 All Curves: Curve data shown represents breaker response at ambient temperature of 77°F (25°C) with no preloading. Breakers are mounted in standard wall-mount position.  
 The minimum inrush pulse tolerance handling capability is 12 times the rated current. These values are based on a 60 Hz 1/2 cycle, 8.33 ms pulse.

**Instantaneous**

**AC**

**DC**

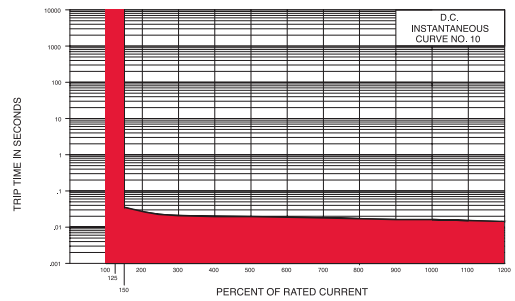
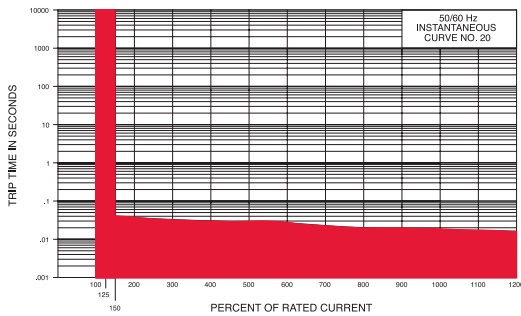

**Ultrashort**

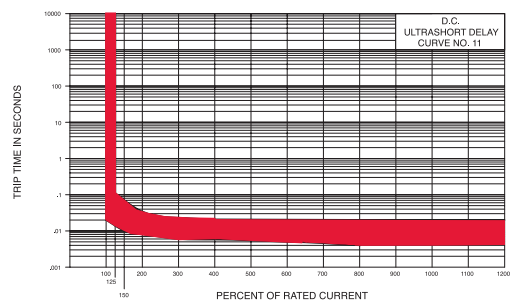
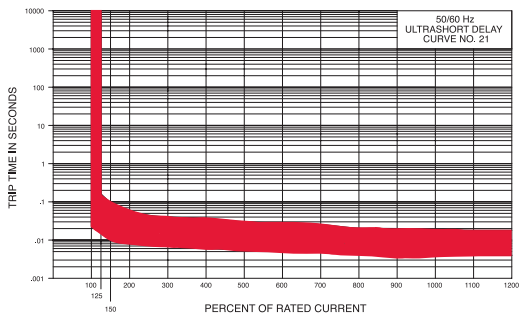

**Short**

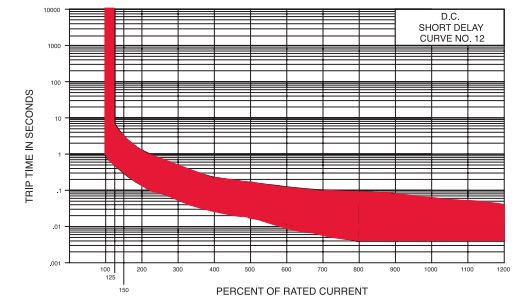
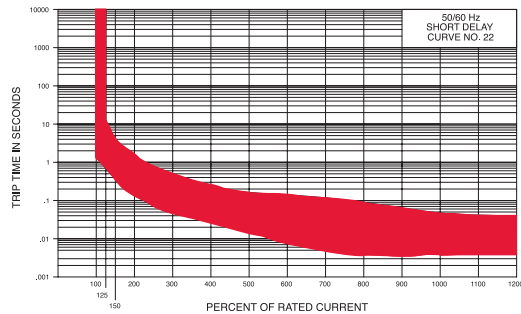

**Medium**

**AC**

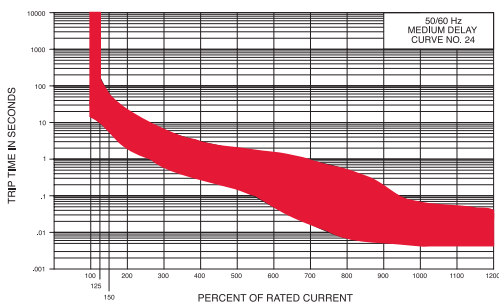

**DC**

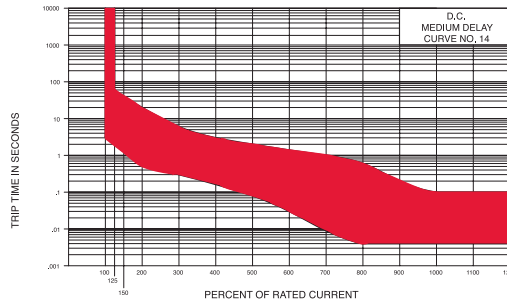

**Long**

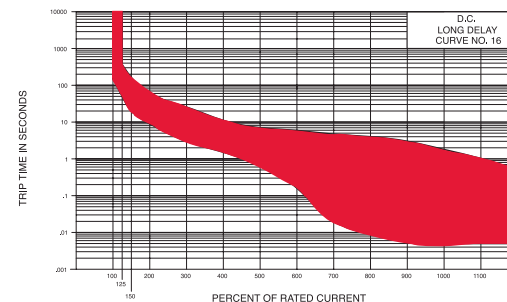
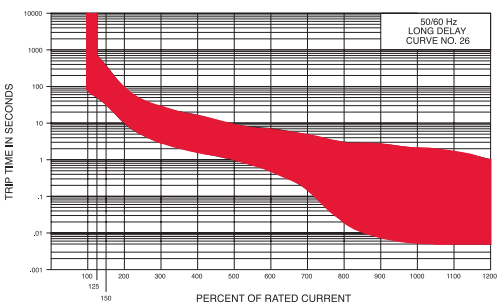

**Short**

**High Inrush AC**

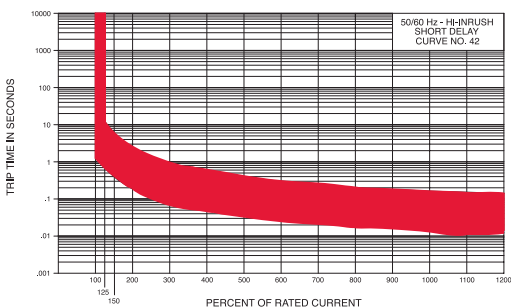

**High Inrush DC**

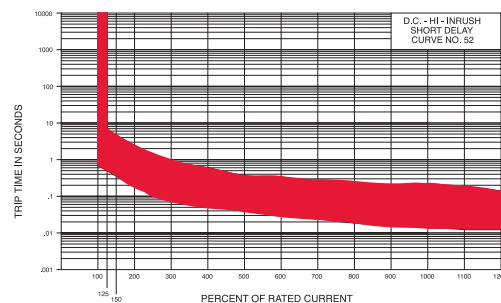

**Medium**

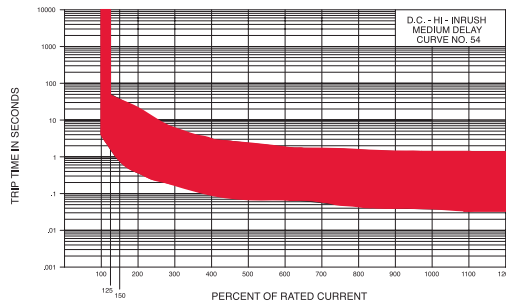
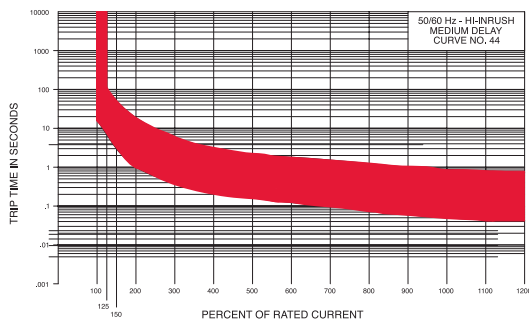

**Long**

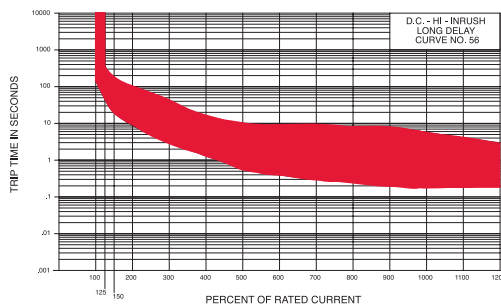
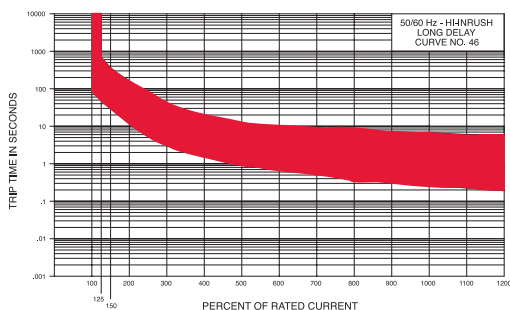



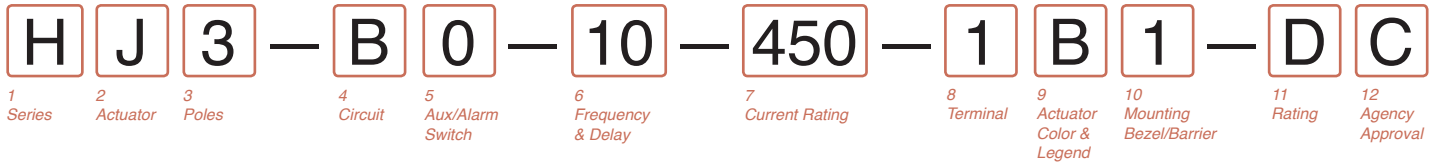

**1 SERIES (VISI ROCKER)**  
**H**

**2 ACTUATOR<sup>1</sup>**  
**J** Vertical - Indicate OFF                      **K** Vertical - Indicate ON

**3 POLE<sup>2</sup>**  
**1** One    **2** Two    **3** Three

**4 CIRCUIT**  
**A** Switch Only (no coil)                      **C<sup>4</sup>** Series Trip (voltage)  
**B** Series Trip (current)                      **G<sup>4</sup>** Relay Trip (voltage)

**5 AUXILIARY/ALARM SWITCH**  
**0** w/o Aux Switch                      **3<sup>3</sup>** 0.110 Q.C. term w/ gold contacts  
**1<sup>3</sup>** 0.110 Q.C. term                      **4<sup>3</sup>** 0.110 PC term  
**2<sup>3</sup>** 0.110 Solder Lug

**6 FREQUENCY & DELAY**

<b>03<sup>3</sup></b> DC 50/60Hz, Switch Only	<b>30</b> DC, 50/60Hz, Instantaneous
<b>10</b> DC Instantaneous	<b>31</b> DC, 50/60Hz, Ultra Short
<b>11</b> DC Ultra Short	<b>32</b> DC, 50/60Hz, Short
<b>12</b> DC Short	<b>34</b> DC, 50/60Hz, Medium
<b>14</b> DC Medium	<b>36</b> DC, 50/60Hz, Long
<b>16</b> DC Long	<b>42<sup>4</sup></b> 50/60Hz Short, Hi-Inrush
<b>20</b> 50/60Hz Instantaneous	<b>44<sup>4</sup></b> 50/60Hz Medium, Hi-Inrush
<b>21</b> 50/60Hz Ultra Short	<b>46<sup>4</sup></b> 50/60Hz Long, Hi-Inrush
<b>22</b> 50/60Hz Short	<b>52<sup>4</sup></b> DC Short, Hi-Inrush
<b>24</b> 50/60Hz Medium	<b>54<sup>4</sup></b> DC Medium, Hi-Inrush
<b>26</b> 50/60Hz Long	<b>56<sup>4</sup></b> DC Long, Hi-Inrush

**7 CURRENT RATING (AMPERES)<sup>5</sup>**

CODE	AMPERES	CODE	AMPERES	CODE	AMPERES	CODE	AMPERES
<b>410</b>	1.000	<b>450</b>	5.000	<b>611</b>	11.000	<b>621</b>	21.000
<b>512</b>	1.250	<b>455</b>	5.500	<b>711</b>	11.500	<b>622</b>	22.000
<b>415</b>	1.500	<b>460</b>	6.000	<b>612</b>	12.000	<b>623</b>	23.000
<b>517</b>	1.750	<b>465</b>	6.500	<b>712</b>	12.500	<b>624</b>	24.000
<b>420</b>	2.000	<b>470</b>	7.000	<b>613</b>	13.000	<b>625</b>	25.000
<b>522</b>	2.250	<b>475</b>	7.500	<b>614</b>	14.000	<b>626</b>	26.000
<b>425</b>	2.500	<b>480</b>	8.000	<b>615</b>	15.000	<b>627</b>	27.000
<b>527</b>	2.750	<b>485</b>	8.500	<b>616</b>	16.000	<b>628</b>	28.000
<b>430</b>	3.000	<b>490</b>	9.000	<b>617</b>	17.000	<b>629</b>	29.000
<b>435</b>	3.500	<b>495</b>	9.500	<b>618</b>	18.000	<b>630</b>	30.000
<b>440</b>	4.000	<b>610</b>	10.000	<b>619</b>	19.000	<b>632</b>	32.000
<b>445</b>	4.500	<b>710</b>	10.500	<b>620</b>	20.000		

**VOLTAGE RATING**

CODE	RATING	TRIP VOLTS	CODE	RATING	TRIP VOLTS	CODE	RATING	TRIP VOLTS
<b>A06</b>	6DC	5DC	<b>A65</b>	65DC	55DC	<b>J65</b>	65AC	55AC
<b>A12</b>	12DC	10DC	<b>J06</b>	6AC	5AC	<b>K20</b>	120AC	65AC
<b>A18</b>	18DC	15DC	<b>J12</b>	12AC	10AC	<b>L40</b>	240AC	130AC
<b>A24</b>	24DC	20DC	<b>J18</b>	18AC	15AC	<b>B10</b>	110DC	59DC
<b>A32</b>	32DC	25DC	<b>J24</b>	24AC	20AC	<b>B20</b>	120DC	65DC
<b>A48</b>	48DC	40DC	<b>J48</b>	48AC	40AC			

**8 TERMINAL**

<b>1</b> Push ON 0.250 Tab (Q.C.)		<b>L</b> 90 Facing Left
<b>2</b> Screw 8-32 w/upturned lugs		<b>R</b> 90 Facing Right
<b>3</b> Screw 8-32 (bus type)		<b>S</b> Straight
<b>A</b> Screw M4 w/upturned lugs		<b>T</b> Straight, Long
<b>B</b> Screw M4 (bus type)		

*Printed Circuitboard Terminals*

**9 ACTUATOR COLOR & LEGEND**

Actuator Color	I-O	ON-OFF	Dual
White	<b>A</b>	<b>B</b>	<b>2</b>
Red	<b>F</b>	<b>G</b>	<b>3</b>
Green	<b>H</b>	<b>J</b>	<b>4</b>
Blue	<b>K</b>	<b>L</b>	<b>5</b>
Yellow	<b>M</b>	<b>N</b>	<b>6</b>
Gray	<b>P</b>	<b>Q</b>	<b>7</b>
Orange	<b>R</b>	<b>S</b>	<b>8</b>

**10 MOUNTING/BARRIERS<sup>5</sup>**

	MOUNTING STYLE	BARRIERS	HALF ROCKER GUARD	BRACKET COLOR
	<b>Threaded Insert</b>			
<b>1</b>	6-32 x 0.195 inches	no	no	Black
<b>A</b>	6-32 x 0.195 inches	yes	no	Black
<b>2</b>	ISO M3 x 5mm	no	no	Black
<b>B</b>	ISO M3 x 5mm	yes	no	Black
<b>3</b>	6-32 x 0.195 inches	no	yes	Black
<b>C</b>	6-32 x 0.195 inches	yes	yes	Black
<b>4</b>	ISO M3 x 5mm	no	yes	Black
<b>D</b>	ISO M3 x 5mm	yes	yes	Black
<b>5</b>	6-32 x 0.195 inches	no	no	White
<b>E</b>	6-32 x 0.195 inches	yes	no	White
<b>6</b>	ISO M3 x 5mm	no	no	White
<b>F</b>	ISO M3 x 5mm	yes	no	White
<b>7</b>	6-32 x 0.195 inches	no	yes	White
<b>G</b>	6-32 x 0.195 inches	yes	yes	White
<b>8</b>	ISO M3 x 5mm	no	yes	White
<b>H</b>	ISO M3 x 5mm	yes	yes	White
<b>9</b>	6-32 x 0.195 inches	no	no	Gray
<b>J</b>	6-32 x 0.195 inches	yes	no	Gray
<b>P</b>	ISO M3 x 5mm	no	no	Gray
<b>K</b>	ISO M3 x 5mm	yes	no	Gray
<b>Q</b>	6-32 x 0.195 inches	no	yes	Gray
<b>L</b>	6-32 x 0.195 inches	yes	yes	Gray
<b>U</b>	ISO M3 x 5mm	no	yes	Gray
<b>M</b>	ISO M3 x 5mm	yes	yes	Gray

**11 MAX. APPLICATION RATING**  
**A** 65DC    **D** 240AC    **M** 80DC<sup>7</sup>    **4** 80VDC/250VAC<sup>8</sup>

**12 AGENCY APPROVAL**  
**A** Without approvals  
**C** UL Recognized, CSA Accepted  
**E** UL Recognized, CSA Accepted, TUV Certified  
**5** UL Recognized, CSA Accepted, TUV Certified, CCC Certified

- Notes:
- Half guard construction have OFF protection for actuator
  - Standard multipole units have all poles identical, except when specifying auxiliary switch
  - Auxiliary switch available on Series Trip and Switch Only circuits to 32A. On multipole units, only one aux. switch is normally supplied, mounted in extreme right pole.
  - Separate Pole Type Voltage Coils not rated for continuous duty. Available only with delay code 10 & 20. Only Available w/ Agency code C.
  - For other current ratings, consult factory.
  - On Visi-Rocker, Visi portion of rocker cannot be the same color as the bezel. Remainder of rocker same color as bezel.
  - 26-32A Polarity sensitive, only available as 1 pole unit.
  - Voltage code 4 available to 25A max.

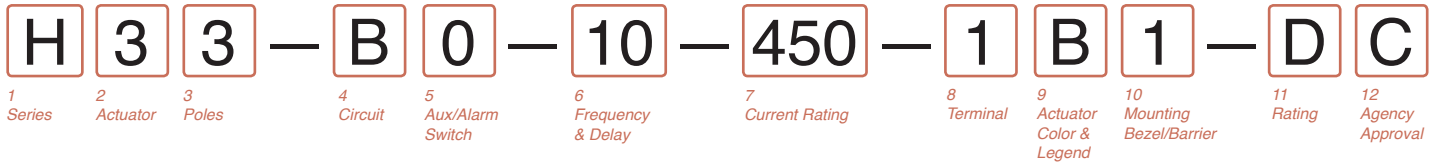

**1 SERIES**  
H

**2 ACTUATOR<sup>1</sup>**  
3 Single Color Vertical    7 Push-to-Reset, Single Color Vertical  
4 Single Color Horizontal    8 Push-to-Reset, Single Color Horizontal

**3 POLE<sup>2</sup>**  
1 One    2 Two    3 Three

**4 CIRCUIT**  
A Switch Only (no coil)    C<sup>4</sup> Series Trip (voltage)  
B Series Trip (current)    G<sup>4</sup> Relay Trip (voltage)

**5 AUXILIARY/ALARM SWITCH**  
0 w/o Aux Switch    3<sup>3</sup> 0.110 Q.C. term w/ gold contacts  
1<sup>3</sup> 0.110 Q.C. term    4<sup>3</sup> 0.110 PC term  
2<sup>3</sup> 0.110 Solder Lug

**6 FREQUENCY & DELAY**  
03<sup>3</sup> DC 50/60Hz, Switch Only    30 DC, 50/60Hz, Instantaneous  
10 DC Instantaneous    31 DC, 50/60Hz, Ultra Short  
11 DC Ultra Short    32 DC, 50/60Hz, Short  
12 DC Short    34 DC, 50/60Hz, Medium  
14 DC Medium    36 DC, 50/60Hz, Long  
16 DC Long    42<sup>4</sup> 50/60Hz Short, Hi-Inrush  
20 50/60Hz Instantaneous    44<sup>4</sup> 50/60Hz Medium, Hi-Inrush  
21 50/60Hz Ultra Short    46<sup>4</sup> 50/60Hz Long, Hi-Inrush  
22 50/60Hz Short    52<sup>4</sup> DC Short, Hi-Inrush  
24 50/60Hz Medium    54<sup>4</sup> DC Medium, Hi-Inrush  
26 50/60Hz Long    56<sup>4</sup> DC Long, Hi-Inrush

**7 CURRENT RATING (AMPERES)<sup>5</sup>**

CODE	AMPERES						
410	1.000	450	5.000	611	11.000	621	21.000
512	1.250	455	5.500	711	11.500	622	22.000
415	1.500	460	6.000	612	12.000	623	23.000
517	1.750	465	6.500	712	12.500	624	24.000
420	2.000	470	7.000	613	13.000	625	25.000
522	2.250	475	7.500	614	14.000	626	26.000
425	2.500	480	8.000	615	15.000	627	27.000
527	2.750	485	8.500	616	16.000	628	28.000
430	3.000	490	9.000	617	17.000	629	29.000
435	3.500	495	9.500	618	18.000	630	30.000
440	4.000	610	10.000	619	19.000	632	32.000
445	4.500	710	10.500	620	20.000		

**VOLTAGE RATING**

CODE	RATING	TRIP VOLTS						
A06	6DC	5DC	A65	65DC	55DC	J65	65AC	55AC
A12	12DC	10DC	J06	6AC	5AC	K20	120AC	65AC
A18	18DC	15DC	J12	12AC	10AC	L40	240AC	130AC
A24	24DC	20DC	J18	18AC	15AC	B10	110DC	59DC
A32	32DC	25DC	J24	24AC	20AC	B20	120DC	65DC
A48	48DC	40DC	J48	48AC	40AC	X01	65AC	special catalog #



**8 TERMINAL**  
1 Push ON 0.250 Tab (Q.C.)    Printed Circuitboard Terminals  
2 Screw 8-32 w/upturned lugs    L 90 Facing Left  
3 Screw 8-32 (bus type)    R 90 Facing Right  
A Screw M4 w/upturned lugs    S Straight  
B Screw M4 (bus type)    T Straight, Long

**9 ACTUATOR COLOR & LEGEND**

Actuator Color	I-O	ON-OFF	Dual	Legend Color
White	A	B	1	Black
Black	C	D	2	White
Red	F	G	3	White
Green	H	J	4	White
Blue	K	L	5	White
Yellow	M	N	6	Black
Gray	P	Q	7	Black
Orange	R	S	8	Black

**10 MOUNTING/BARRIERS<sup>5</sup>**

MOUNTING STYLE	BARRIERS	PUSH-TO-RESET	BRACKET COLOR
<b>Threaded Insert</b>			
1 6-32 x 0.195 inches	no	no	Black
A 6-32 x 0.195 inches	yes	no	Black
2 ISO M3 x 5mm	no	no	Black
B ISO M3 x 5mm	yes	no	Black
3 6-32 x 0.195 inches	no	yes	Black
C 6-32 x 0.195 inches	yes	yes	Black
4 ISO M3 x 5mm	no	yes	Black
D ISO M3 x 5mm	yes	yes	Black
5 6-32 x 0.195 inches	no	no	White
E 6-32 x 0.195 inches	yes	no	White
6 ISO M3 x 5mm	no	no	White
F ISO M3 x 5mm	yes	no	White
7 6-32 x 0.195 inches	no	yes	White
G 6-32 x 0.195 inches	yes	yes	White
8 ISO M3 x 5mm	no	yes	White
H ISO M3 x 5mm	yes	yes	White
9 6-32 x 0.195 inches	no	no	Gray
J 6-32 x 0.195 inches	yes	no	Gray
P ISO M3 x 5mm	no	no	Gray
K ISO M3 x 5mm	yes	no	Gray
Q 6-32 x 0.195 inches	no	yes	Gray
L 6-32 x 0.195 inches	yes	yes	Gray
U ISO M3 x 5mm	no	yes	Gray
M ISO M3 x 5mm	yes	yes	Gray

**11 MAX. APPLICATION RATING**  
A 65DC    D 240AC    M 80DC<sup>7</sup>    4 80VDC/250VAC<sup>8</sup>

**12 AGENCY APPROVAL**  
A Without approvals  
C UL Recognized, CSA Accepted, CCC Certified  
E UL Recognized, CSA Accepted, TUV Certified  
5 UL Recognized, CSA Accepted, TUV Certified, CCC Certified

Notes:  
1 Push-To-Reset actuator shave OFF portion of rocker shrouded  
2 Standard multipole units have all poles identical, except when specifying auxiliary switch  
3 Auxiliary switch available on Series Trip and Switch Only circuits to 32A. On multipole units, only one aux. switch is normally supplied, mounted in extreme right pole.  
4 Separate Pole Type Voltage Coils not rated for continuous duty. Available only with delay code 10 & 20. Only Available w/ Agency code C.  
5 For other current ratings, consult factory.  
6 On Visi-Rocker, Visi portion of rocker cannot be the same color as the bezel. Remainder of rocker same color as bezel.  
7 26-32A Polarity sensitive, only available as 1 pole unit.  
8 Voltage code 4 available to 25A max.

\* Intentionally left blank

### **Worldwide Headquarters**

Carling Technologies, Inc.  
60 Johnson Avenue • Plainville, CT 06062-1177  
Phone: (860) 793-9281 • Fax: (860) 793-9231  
Email: sales@carlingtech.com • www.carlingtech.com

East Region Sales Office, CT • ersm@carlingtech.com  
Midwest Region Sales Office, IL • mrs@carlingtech.com  
West Region Sales Office, CA • wrsm@carlingtech.com

### **Asia-Pacific Headquarters**

Carling Technologies, Asia-Pacific Ltd.,  
Kowloon, Hong Kong  
Int + 852-2737-2277 • Fax: Int + 852-2736-9332  
Email: sales@carlingtech.com.hk

Shenzhen, China • shenzhen@carlingtech.com  
Shanghai, China • shanghai@carlingtech.com  
Pune, India • india@carlingtech.com  
Kaohsiung, Taiwan • taiwan@carlingtech.com  
Yokohama, Japan • japan@carlingtech.com

### **Europe / Middle East / Africa Headquarters**

Carling Technologies, Ltd.,  
Devon, England 06062-1177  
Int + 44 1392-364422 • Fax: Int + 44 1392-364477  
Email: ltd.sales@carlingtech.com

GmbH, Germany • gmbh@carlingtech.com  
SAS, France • sas@carlingtech.com

REV\_CB\_H\_0212



**Carling Technologies™**

Innovative Designs. Powerful Solutions.

Innovative Designs. Powerful Solutions.





Компания «ЭлектроПласт» предлагает заключение долгосрочных отношений при поставках импортных электронных компонентов на взаимовыгодных условиях!

Наши преимущества:

- Оперативные поставки широкого спектра электронных компонентов отечественного и импортного производства напрямую от производителей и с крупнейших мировых складов;
- Поставка более 17-ти миллионов наименований электронных компонентов;
- Поставка сложных, дефицитных, либо снятых с производства позиций;
- Оперативные сроки поставки под заказ (от 5 рабочих дней);
- Экспресс доставка в любую точку России;
- Техническая поддержка проекта, помощь в подборе аналогов, поставка прототипов;
- Система менеджмента качества сертифицирована по Международному стандарту ISO 9001;
- Лицензия ФСБ на осуществление работ с использованием сведений, составляющих государственную тайну;
- Поставка специализированных компонентов (Xilinx, Altera, Analog Devices, Intersil, Interpoint, Microsemi, Aeroflex, Peregrine, Syfer, Eurofarad, Texas Instrument, Miteq, Cobham, E2V, MA-COM, Hittite, Mini-Circuits, General Dynamics и др.);

Помимо этого, одним из направлений компании «ЭлектроПласт» является направление «Источники питания». Мы предлагаем Вам помощь Конструкторского отдела:

- Подбор оптимального решения, техническое обоснование при выборе компонента;
- Подбор аналогов;
- Консультации по применению компонента;
- Поставка образцов и прототипов;
- Техническая поддержка проекта;
- Защита от снятия компонента с производства.



#### Как с нами связаться

**Телефон:** 8 (812) 309 58 32 (многоканальный)

**Факс:** 8 (812) 320-02-42

**Электронная почта:** [org@eplast1.ru](mailto:org@eplast1.ru)

**Адрес:** 198099, г. Санкт-Петербург, ул. Калинина, дом 2, корпус 4, литера А.