

**LA4440****6W 2-Channel, Bridge 19W typ Power Amplifier****Features**

- Built-in 2 channels (dual) enabling use in stereo and bridge amplifier applications.
 - Dual : 6W×2 (typ.)
 - Bridge : 19W (typ.)
- Minimum number of external parts required.
- Small pop noise at the time of power supply ON/OFF and good starting balance.
- Good ripple rejection : 46dB (typ.)
- Good channel separation.
- Small residual noise (Rg=0).
- Low distortion over a wide range from low frequencies to high frequencies.
- Easy to design radiator fin.
- Built-in audio muting function.
- Built-in protectors.
 - a. Thermal protector
 - b. Overvoltage, surge voltage protector
 - c. Pin-to-pin short protector

Package Dimensions

unit:mm

3023A-SIP14H

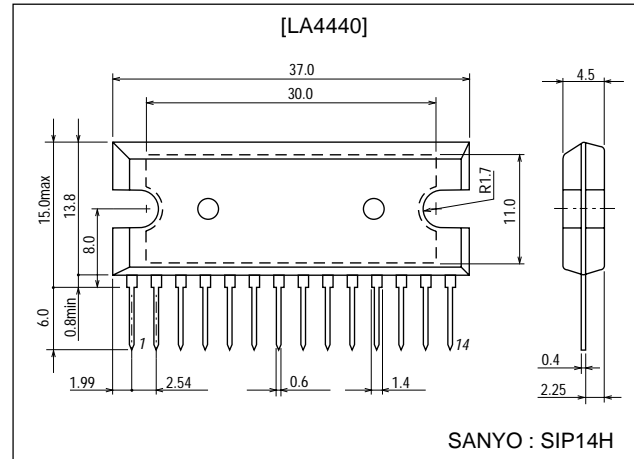
**Specifications****Absolute Maximum Ratings** at $T_a = 25^\circ\text{C}$

Parameter	Symbol	Conditions	Ratings	Unit
Maximum supply voltage	$V_{CC \text{ max1}}$	Quiescent ($t=30\text{s}$)	25	V
	$V_{CC \text{ max2}}$	Operating	18	V
Surge supply voltage	$V_{CC(\text{surge})}$	$t \leq 0.2\text{s}$	50	V
Allowable power dissipation	$P_d \text{ max}$	$T_c = 75^\circ\text{C}$, See $P_d \text{ max} - T_a$ characteristic	15	W
Thermal resistance	θ_{j-c}	Junction-to-case	3	$^\circ\text{C/W}$
Operating temperature	T_{opr}		-20 to +75	$^\circ\text{C}$
Storage temperature	T_{stg}		-40 to +150	$^\circ\text{C}$

Recommended Operating Conditions at $T_a = 25^\circ\text{C}$

Parameter	Symbol	Conditions	Ratings	Unit
Supply voltage	V_{CC}		13.2	V
Load resistance	R_L	Stereo	2 to 8	Ω
		Bridge	4 to 8	Ω

■ Any and all SANYO products described or contained herein do not have specifications that can handle applications that require extremely high levels of reliability, such as life-support systems, aircraft's control systems, or other applications whose failure can be reasonably expected to result in serious physical and/or material damage. Consult with your SANYO representative nearest you before using any SANYO products described or contained herein in such applications.

■ SANYO assumes no responsibility for equipment failures that result from using products at values that exceed, even momentarily, rated values (such as maximum ratings, operating condition ranges, or other parameters) listed in products specifications of any and all SANYO products described or contained herein.

SANYO Electric Co., Ltd. Semiconductor Company

TOKYO OFFICE Tokyo Bldg., 1-10, 1 Chome, Ueno, Taito-ku, TOKYO, 110-8534 JAPAN

21500TH (KT)/90196RM/33194HO/8064KI/3233KI/O070KI, TS No.750-1/13

LA4440

Operating Characteristics at $T_a = 25^\circ\text{C}$, $V_{CC} = 13.2\text{V}$, $R_L = 4\Omega$, $f = 1\text{kHz}$, $R_g = 600\Omega$, with $100 \times 100 \times 1.5\text{mm}^3$ Al fin,

See specified Test Circuit.

Parameter	Symbol	Conditions	Ratings			Unit
			min	typ	max	
Quiescent current	I_{CCO}			100	200	mA
Voltage gain	VG		49.5	51.5	53.5	dB
Output power	P_O	THD=10%, Stereo	5.0	6.0		W
		THD=10%, Bridge		19		W
Total harmonic distortion	THD	$P_O = 1\text{W}$		0.1	1.0	%
Input resistance	r_i			30k		Ω
Output noise voltage	V_{NO}	$R_g = 0$		0.6	1.0	mV
		$R_g = 10\text{k}\Omega$		1.0	2.0	mV
Ripple rejection ratio	R_r	$V_R = 200\text{mV}$, $f_R = 100\text{Hz}$, $R_g = 0$		46		dB
Channel separation	Ch sep	$V_O = 0\text{dBm}$, $R_g = 10\text{k}\Omega$	45	55		dB
Muting attenuation	ATT	$V_O = 0\text{dBm}$, $V_M = 9\text{V}$		40		dB
Gain difference between channels	ΔVG				2	dB

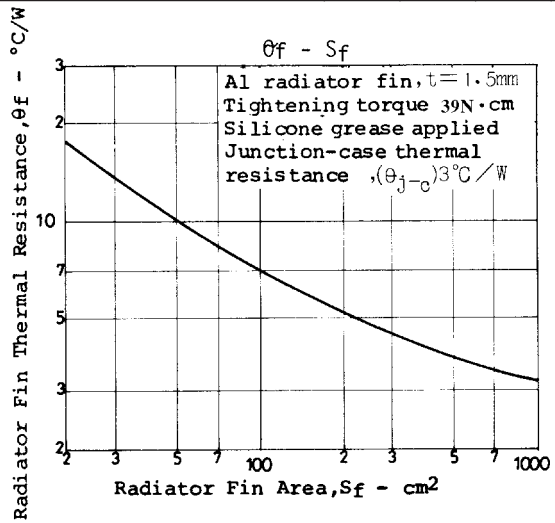
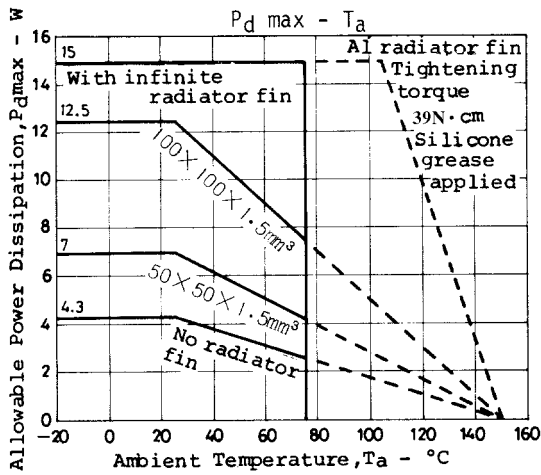

Equivalent Circuit Block Diagram

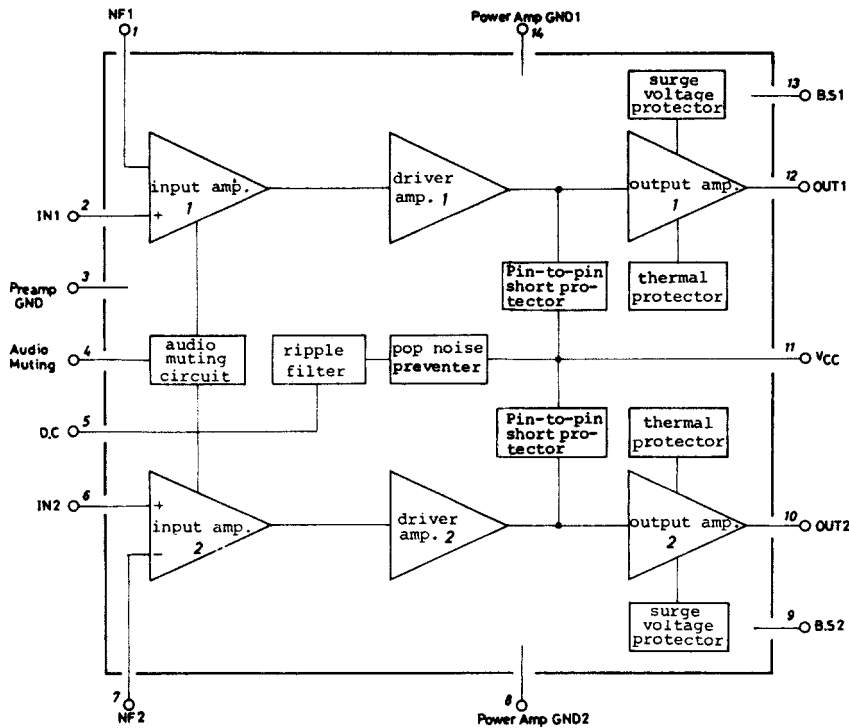

LA4440

Sample Application Circuit 1. Stereo use

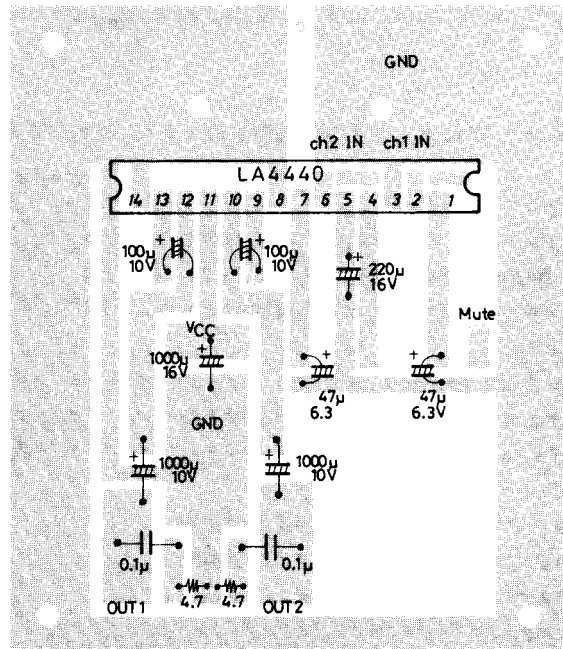
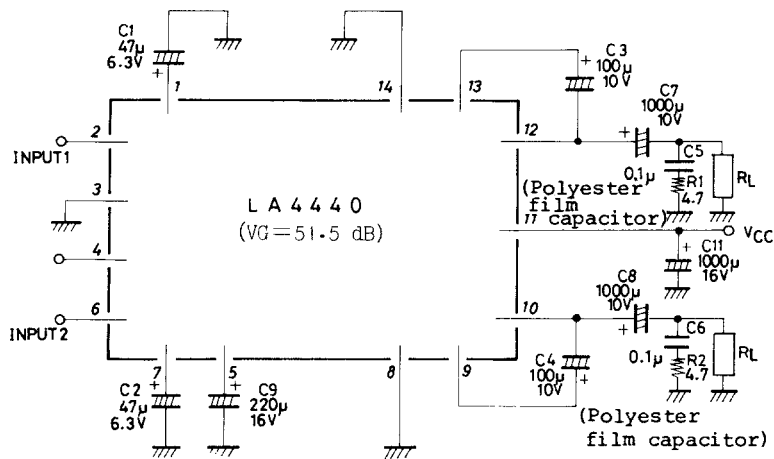

Sample printed circuit pattern for dual mode
(Cu-foiled area) 60 x 70 mm²

Sample Application Circuit 2. Bridge amplifier 1

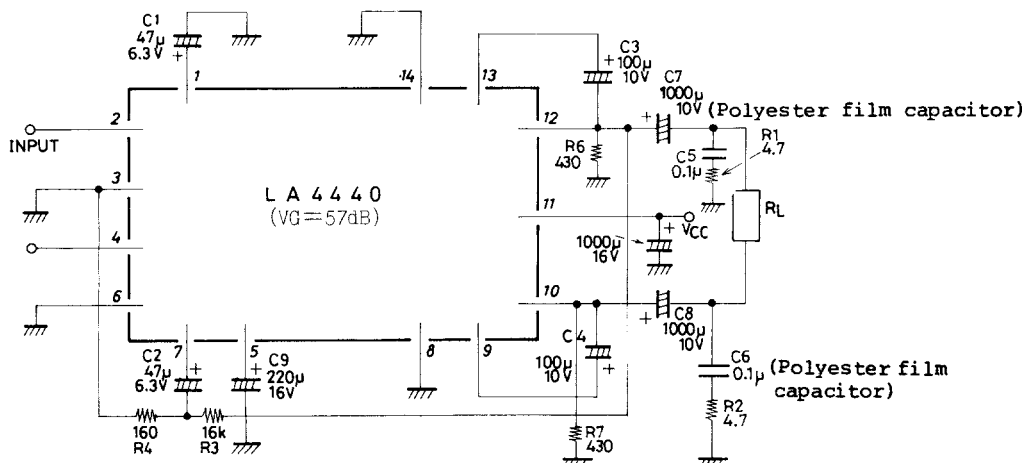

Sample Application Circuit 3. Bridge amplifier 2

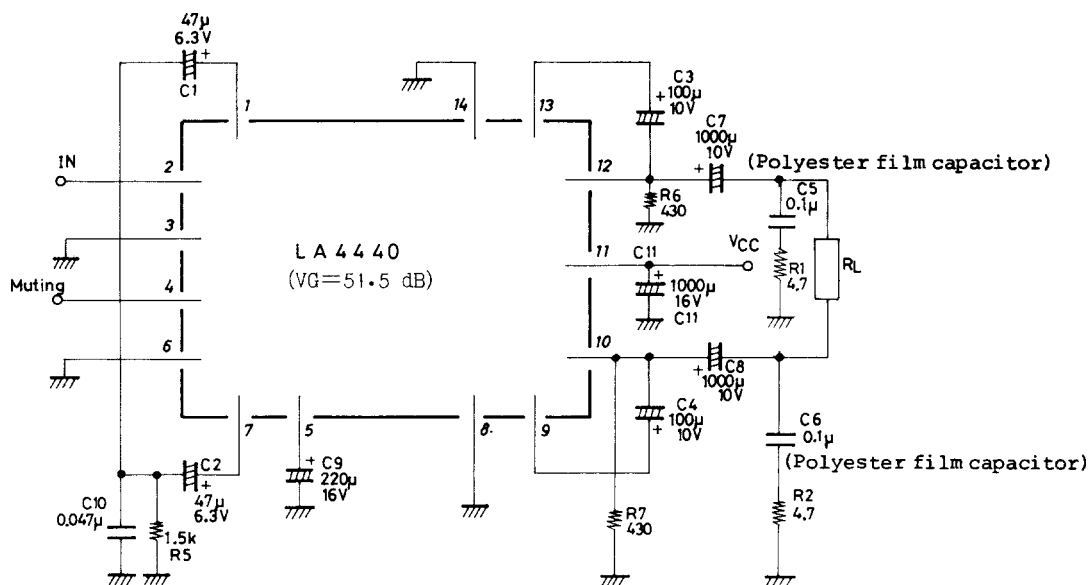

Description of External Parts

- C1 (C2) · Feedback capacitor : The low cutoff frequency depends on this capacitor. If the capacitance value is increased, the starting time is delayed.
- C3 (C4) · Bootstrap capacitor : If the capacitance value is decreased, the output at low frequencies goes lower.
- C5 (C6) · Oscillation preventing capacitor : Polyester film capacitor, being good in temperature characteristic, frequency characteristic, is used. The capacitance value can be reduced to 0.047µF depending on the stability of the board.
- C7 (C8) · Output capacitor : The low cutoff frequency depends on this capacitor. At the bridge amplifier mode, the output capacitor is generally connected.
- C9 · Decoupling capacitor :Used for the ripple filter. Since the rejection effect is saturated at a certain capacitance value, it is meaningless to increase the capacitance value more than required. This capacitor, being also used for the time constant of the muting circuit, affects the starting time.
- R1 (R2) · Filter resistor for preventing oscillation.
- R3 (R4) · Resistor for making input signal of inverting amplifier in Voltage Gain Adjust at Bridge Amplifier Mode (No. 1).
- R5 · Resistor for adjusting starting time in Voltage Gain Adjust at Bridge Amplifier Mode (No. 2)
- C10 · Capacitor for preventing oscillation in Voltage Gain Adjust at Bridge Amplifier Mode (No. 2)
- C11 · Power source capacitor.
- R6 (R7) · Used at bridge amplifier mode in order to increase discharge speed and to secure transient stability.

Features of IC System and Functions of Remaining Pins

- (a) Since the input circuit uses PNP transistors and the input potential is designed to be 0 bias, no input coupling capacitor is required and direct coupling is available. However, when slider contact noise caused by the variable resistor presents a problem, connect a capacitor in series with the input.
- (b) The open-loop voltage gain is lowered and the negative feedback amount is reduced for stabilization. An increase in distortion resulted from the reduced negative feedback amount is avoided by use of the built-in unique distortion reduction circuit, and thus distortion is kept at 0.1% (typ.).
- (c) A capacitor for oscillation compensation is contained as a means of reducing the number of external parts. The capacitance value is 35pF which determines high cutoff frequency f_H (-3dB point) of the amplifier ($f_H \approx 20\text{kHz}$).
- (d) For preventing the IC from being damaged by a surge applied on the power line, an overvoltage protector is contained. Overvoltage setting is 25V. It is capable of withstanding up to 50V at giant pulse surge 200ms.
- (e) No damage occurs even when power is applied at a state where pins 10, 11, and 12 are short-circuited with solder bridge, etc.
- (f) To minimize the variations in voltage gain, feedback resistor R_{NF} is contained and voltage gain (51.5dB) is fixed.

Voltage Gain Adjust at Stereo Mode

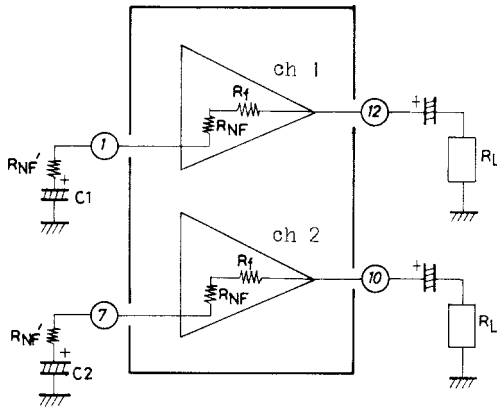

$R_{NF}=50\Omega$ (typ), $R_f=20k\Omega$ (typ)
At $R_{NF}'=0$ (recommended VG)

$$VG=20\log \frac{VG}{R_{NF}} \text{ (dB)}$$

In case of using R_{NF}'

$$VG=20\log \frac{R_f}{R_{NF}+R_{NF}'} \text{ (dB)}$$

Voltage Gain Adjust at Bridge Amplifier Mode (No. 1)

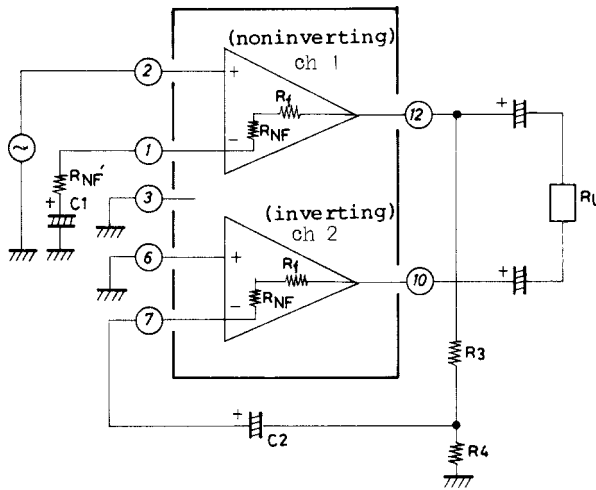

The bridge amplifier configuration is as shown left, in which ch1 and ch2 operate as noninverting amplifier and inverting amplifier respectively. The output of the noninverting amplifier divided by resistors R_3 , R_4 is applied, as input, to the inverting amplifier. Since attenuation (R_4/R_3) of the non-inverting amplifier output and amplification factor (R_f/R_4+R_{NF}) of the inverting amplifier are fixed to be the same, signals of the same level and 180° out of phase with each other can be obtained at output pins (12) and (10). The total voltage gain is apparently higher than that of the noninverting amplifier by 6dB and is approximately calculated by the following formula.

$$VG=20\log \frac{R_f}{R_{NF}} + 6\text{dB}$$

In case of reducing the voltage gain, R_{NF}' is connected to the noninverting amplifier side only and the following formula is used.

$$VG=20\log \frac{R_f}{R_{NF}+R_{NF}'} + 6\text{dB}$$

Voltage Gain Adjust at Bridge Amplifier Mode (No. 2)

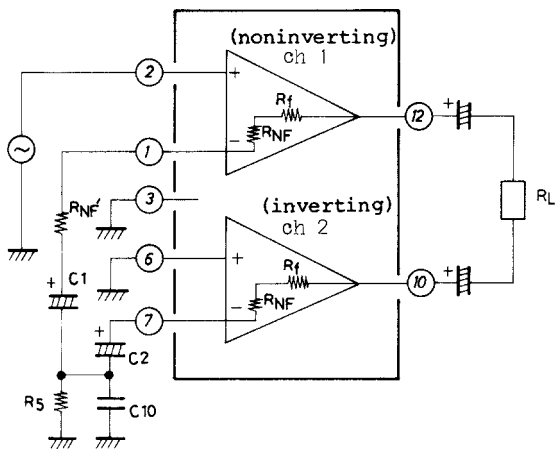

$$VG=20\log \frac{R_f}{\frac{R_{NF}+R_{NF}'}{2}} \text{ (dB)}$$

where $(R_{NF}+R_{NF}') \ll R_5$

From this formula, it is seen that connecting R_{NF}' causes the voltage gain to be reduced at the modes of both stereo amplifier and bridge amplifier.

LA4440

(g) In case of applying audio muting in each application circuit, the following circuit is used.

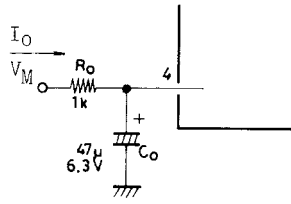

$6V \leq V_M \leq V_{CC}$
 Recommended $V_M = 9V$
 $A_{TT} = 40dB$ ($R_g = 600\Omega$)

Flow-in current I_O is calculated by the following formula.

$$I_O = \frac{V_M - V_{BE}}{R_O}$$

In case of increasing the muting attenuation, resistor 5.6kΩ is connected in series with the input, and then the attenuation is made to be 55dB. Be careful that connecting an input capacitor causes pop noise to be increased at the time of application of AC muting. Increased R_O , C_O make it possible to reduce the noise. In case of completely cutting off power IC, pin (5) is grounded, and then DC control is available and the attenuation is made to be ∞ .

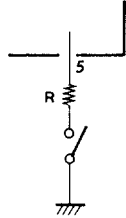

General-purpose switch

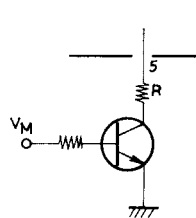

Transistor switch

Stereo : $20\Omega \leq R \leq 100\Omega$
 Bridge No.1 : $20\Omega \leq R \leq 100\Omega$
 Bridge No. 2 : $0\Omega \leq R \leq 50\Omega$

Pin Voltage (unit : V)

Pin No.	1	2	3	4	5	6	7	8	9	10	11	12	13	14
Function pin	CH1 NF	CH1 NF	Pre GND	AC Audio Muting	DC	CH2 IN	CH2 NF	CH2 Power GND	CH2 BS	CH2 OUT	V_{CC}	CH1 OUT	CH1 BS	CH1 Power GND
Pin Voltage at quiescent mode	1.4	0.03	0	0	13.0	0.03	1.4	0	11.9	6.8	13.2	6.8	11.9	0

Proper Cares in Using IC

· Maximum ratings

If the IC is used in the vicinity of the maximum ratings, even a slight variation in conditions may cause the maximum ratings to be exceeded, thereby leading to breakdown. Allow an ample margin of variation for supply voltage, etc. and use the IC in the range where the maximum ratings are not exceeded.

· Printed circuit board

When making the board, refer to the sample printed circuit pattern and be careful that no feedback loop is formed between input and output.

· Oscillation preventing capacitor

Normally, a polyester film capacitor is used for $0.1\mu F + 4.7\Omega$. The capacitance value can be reduced to $0.047\mu F$ depending on the stability of the board.

· Others

Connect the radiator fin of the package to GND.

LA4440

Characteristics at stereo amplifier mode

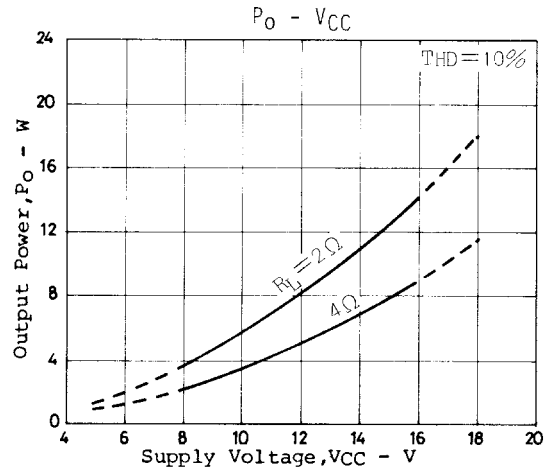
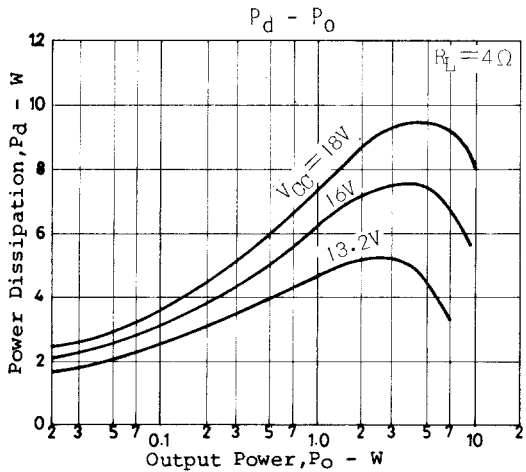
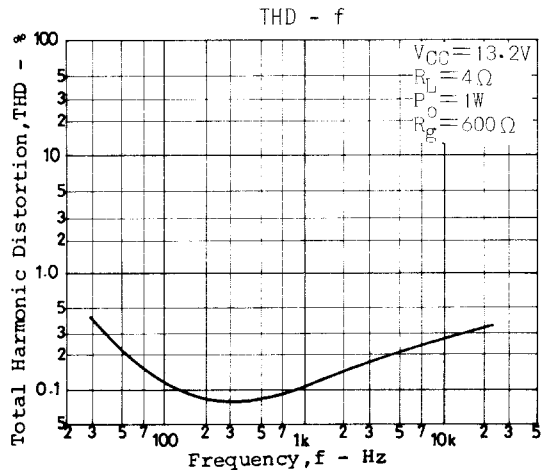
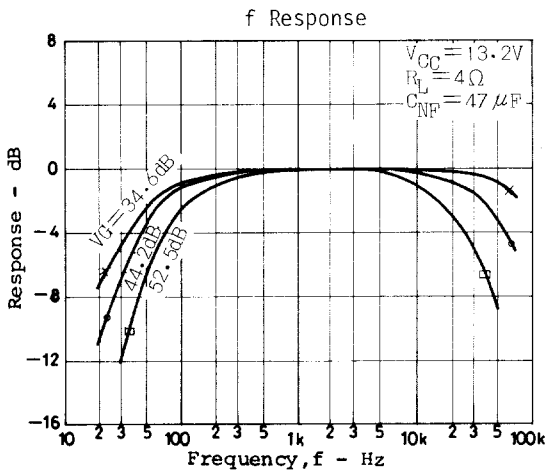
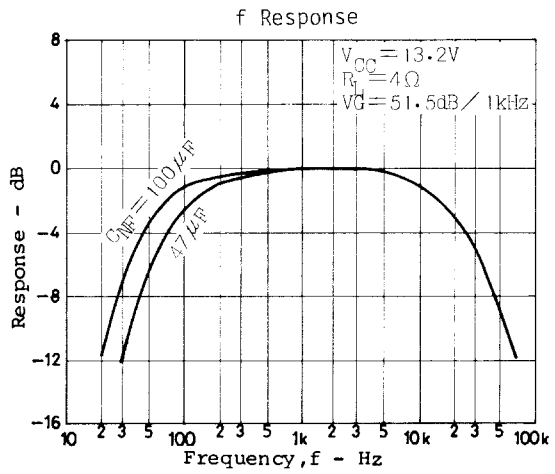
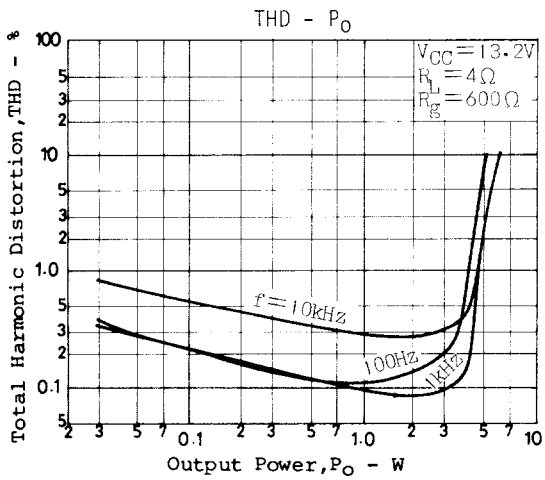
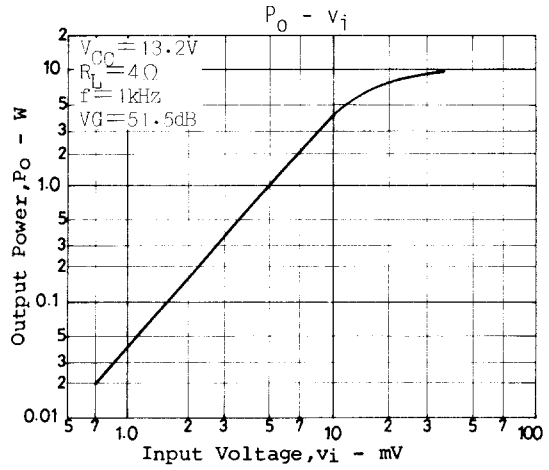
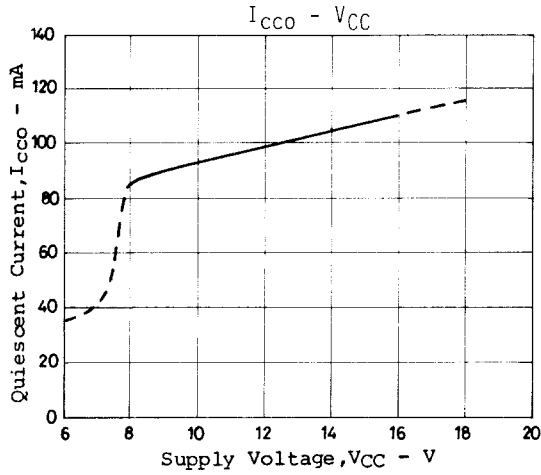

LA4440

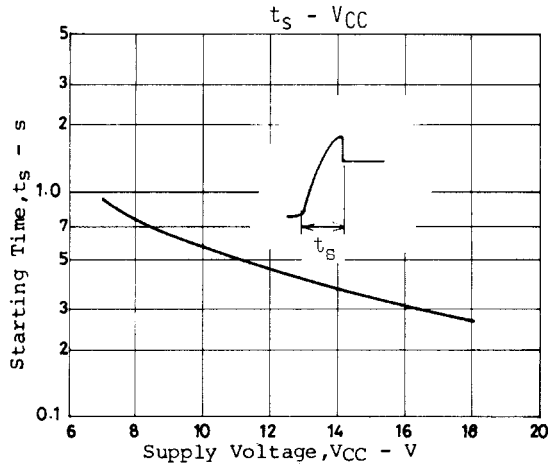
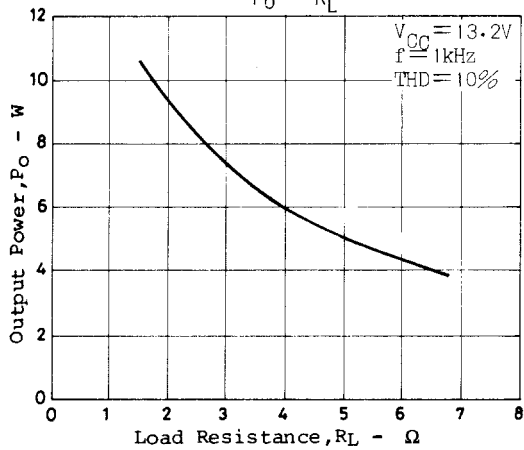
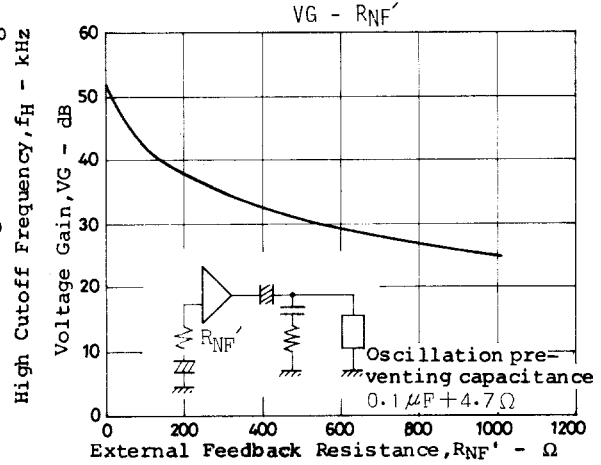
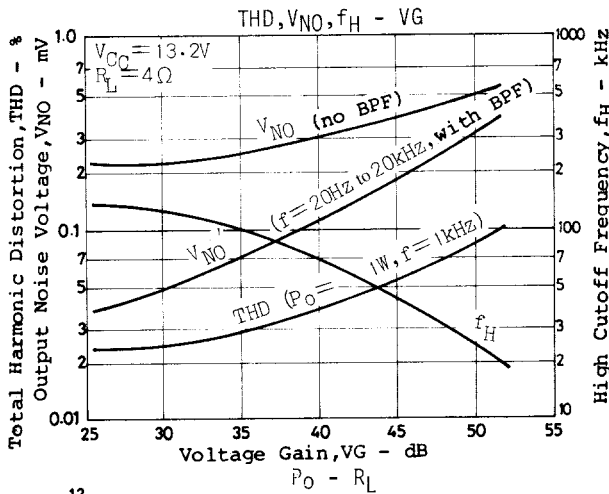
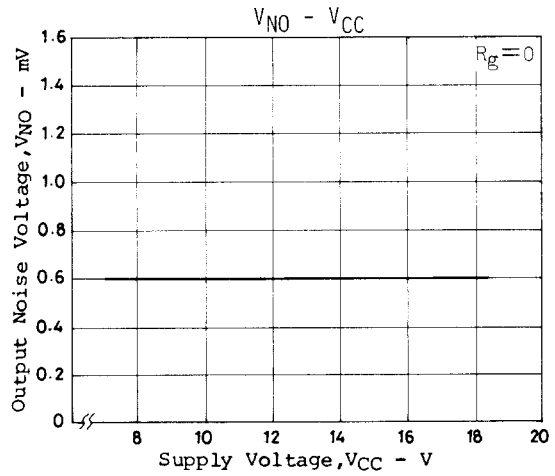
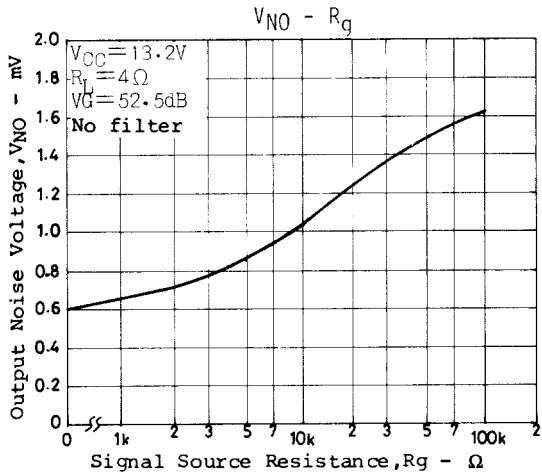
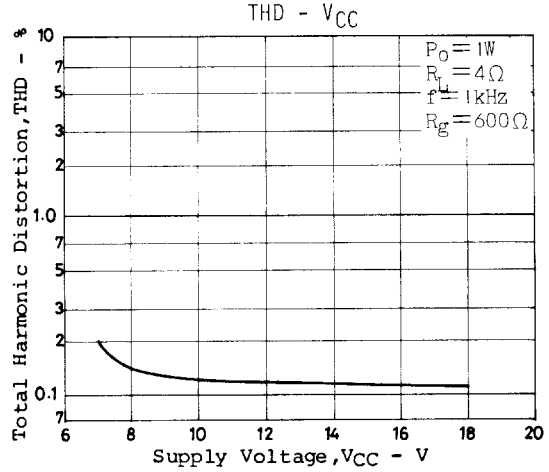
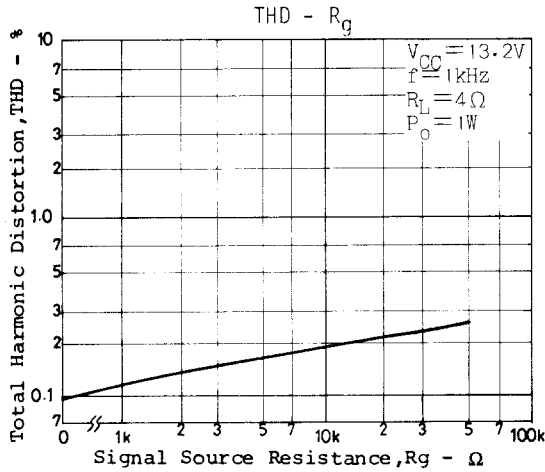

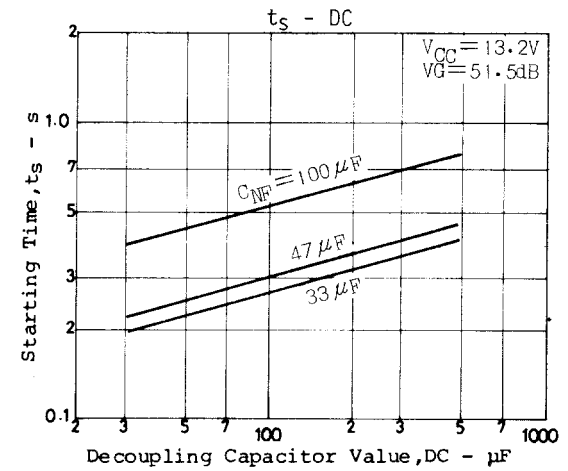
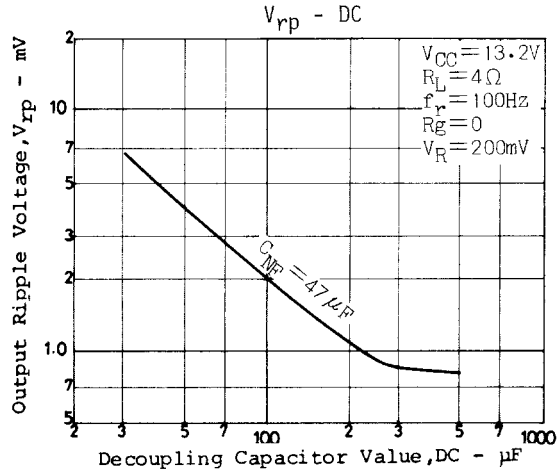
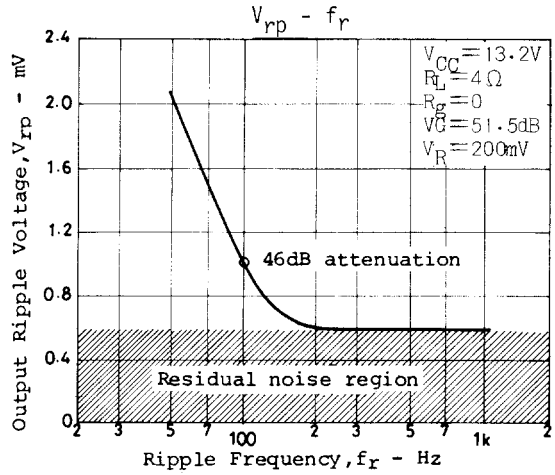
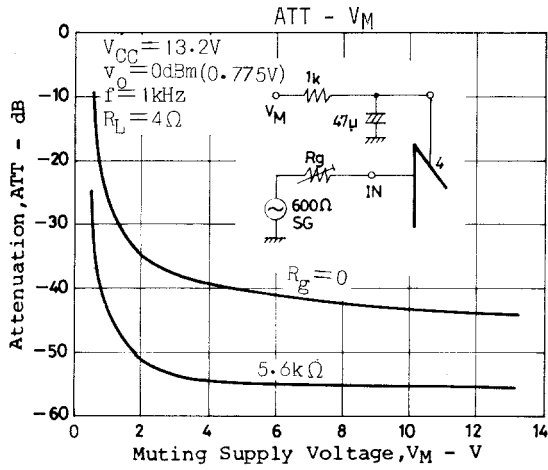

Characteristics at bridge amplifier mode No. 1

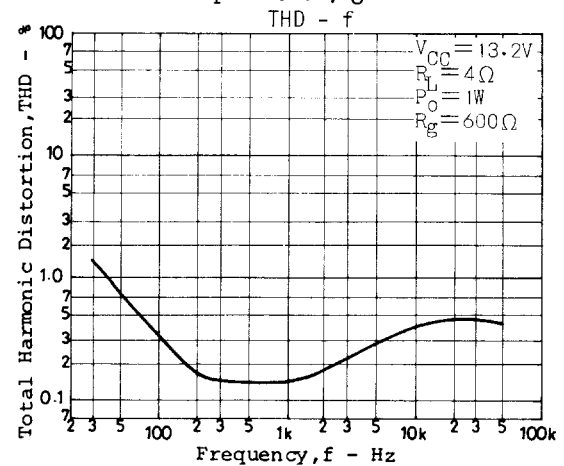
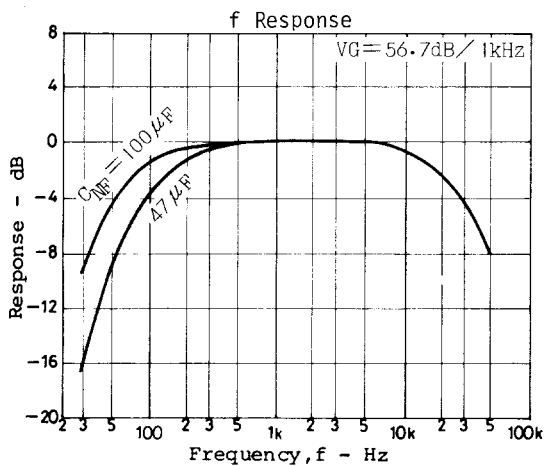
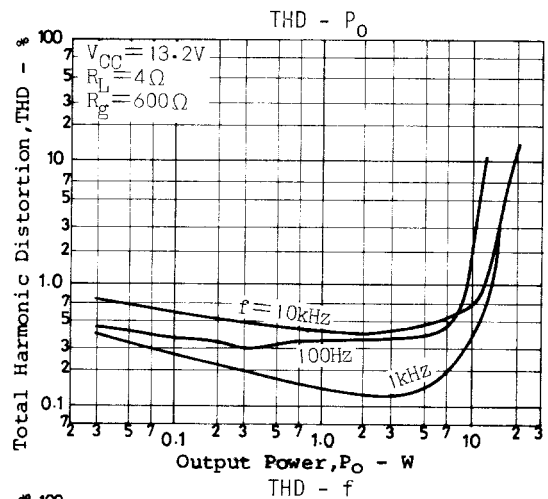
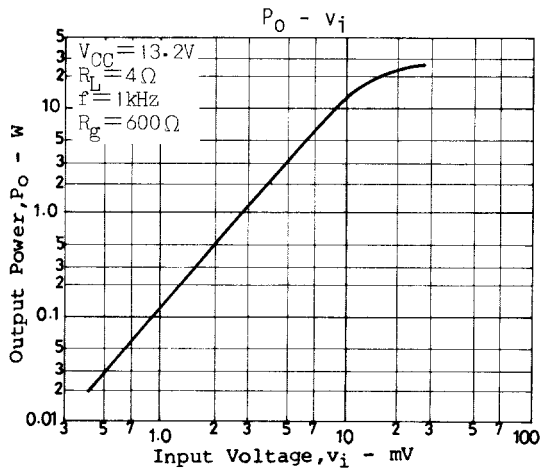

LA4440

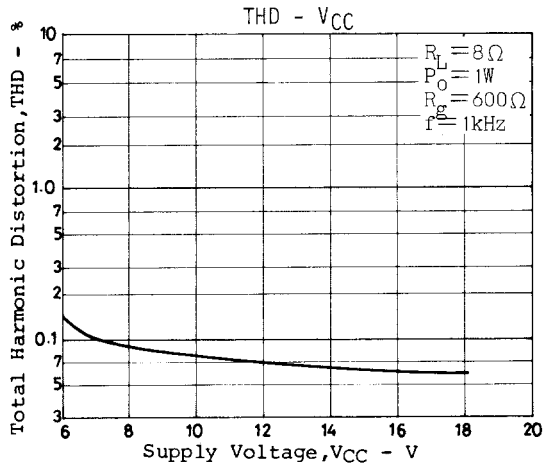
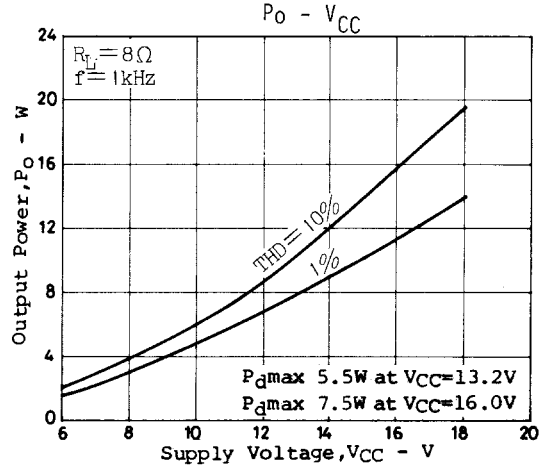
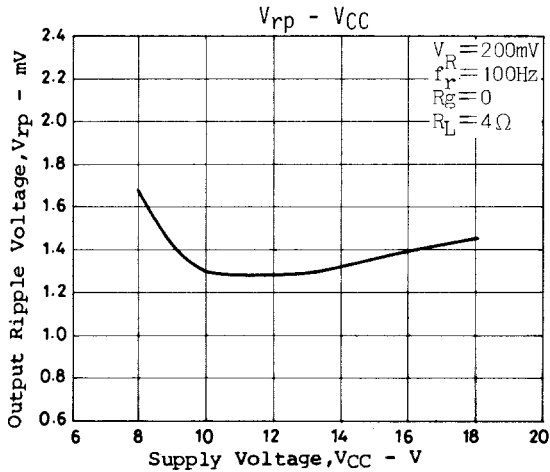
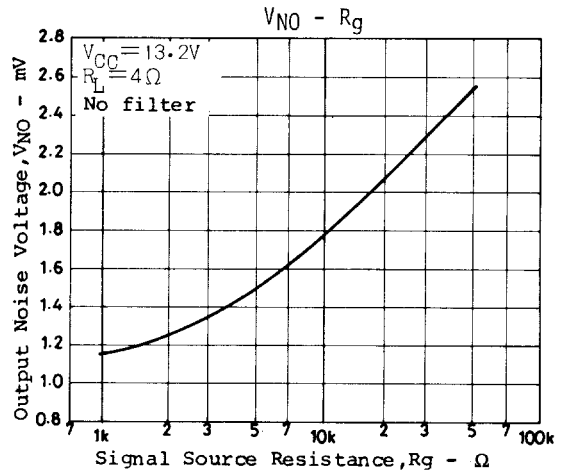
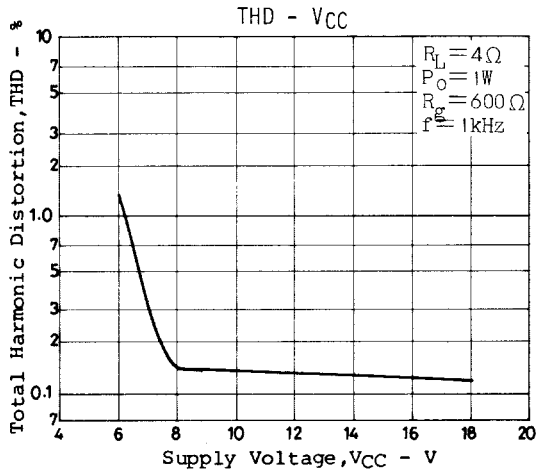
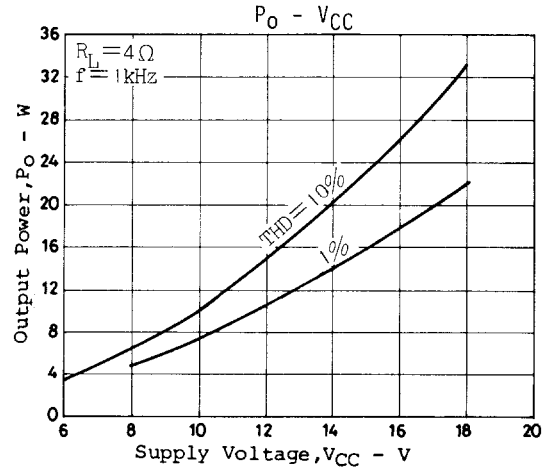
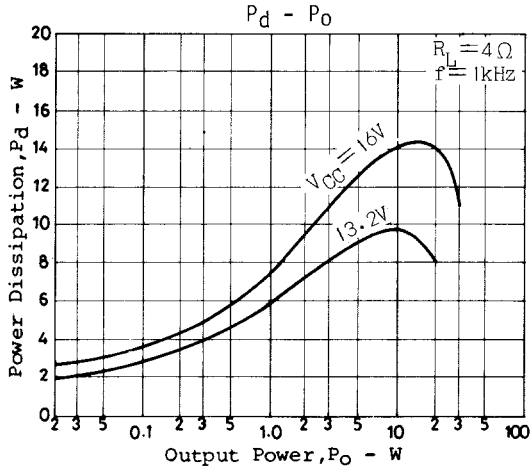

LA4440

Characteristics at bridge amplifier mode No. 2

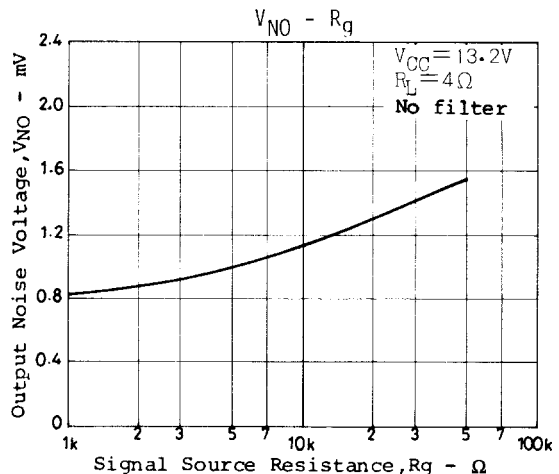
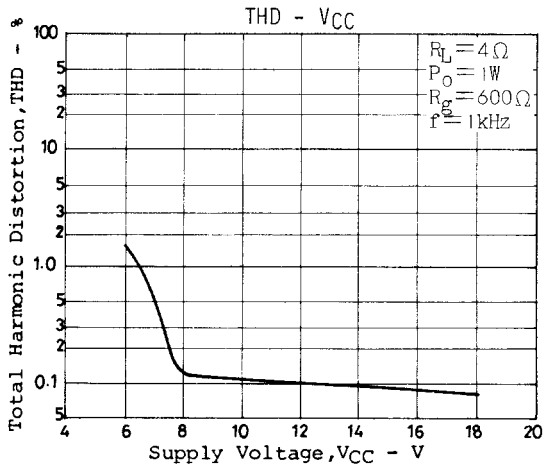
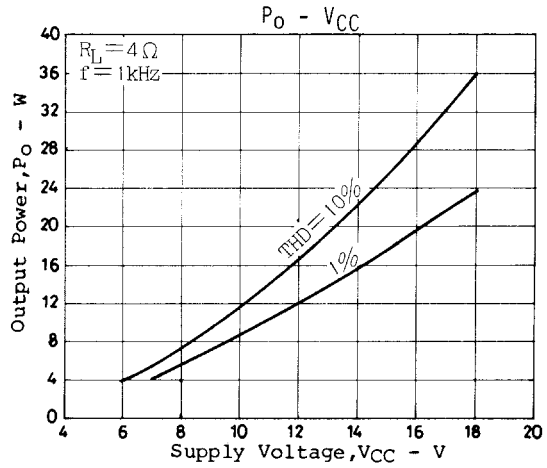
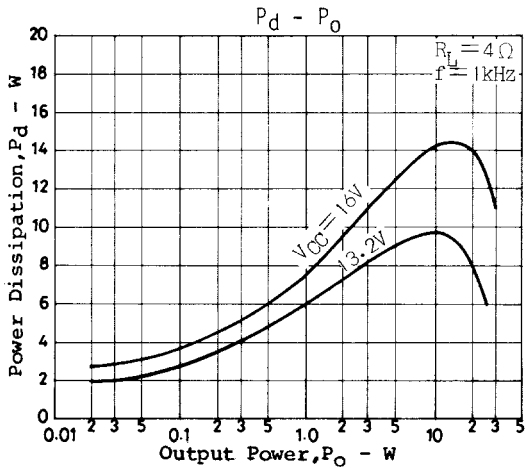
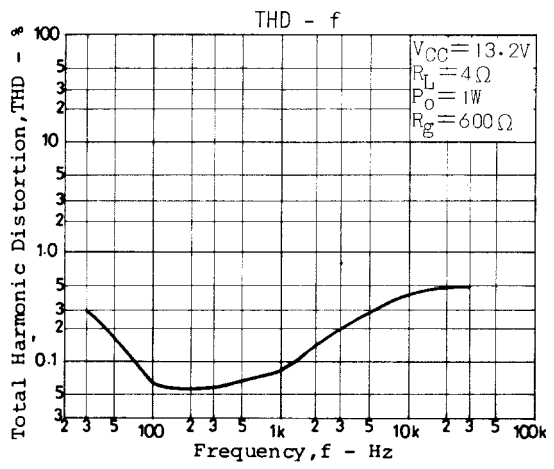
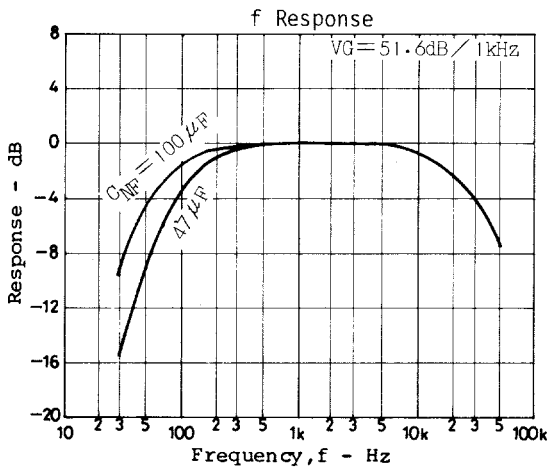
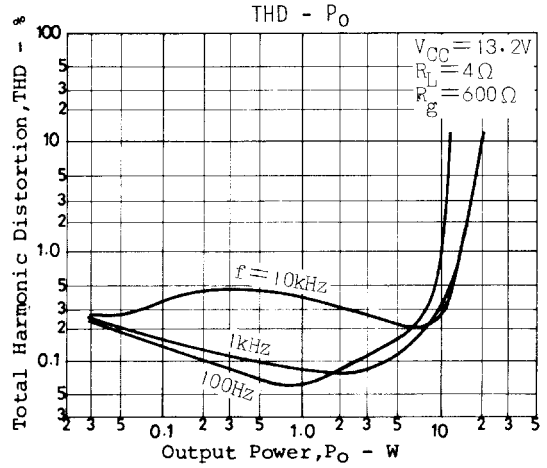
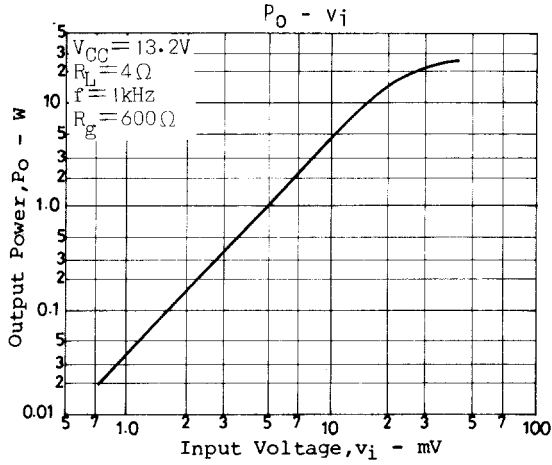

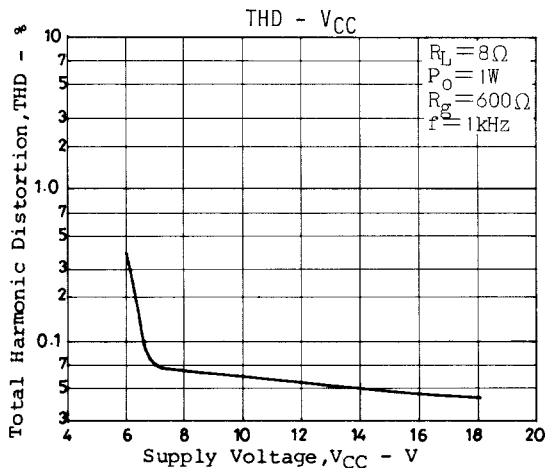
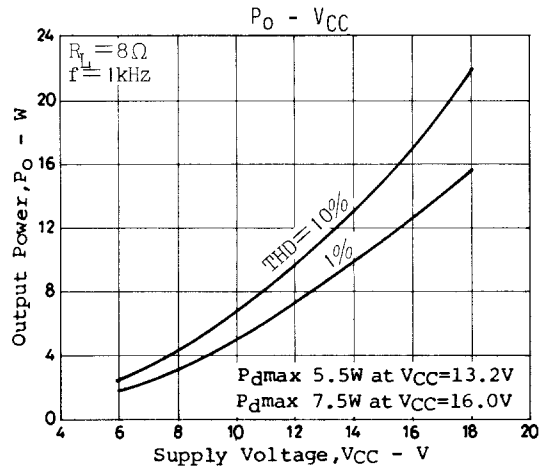
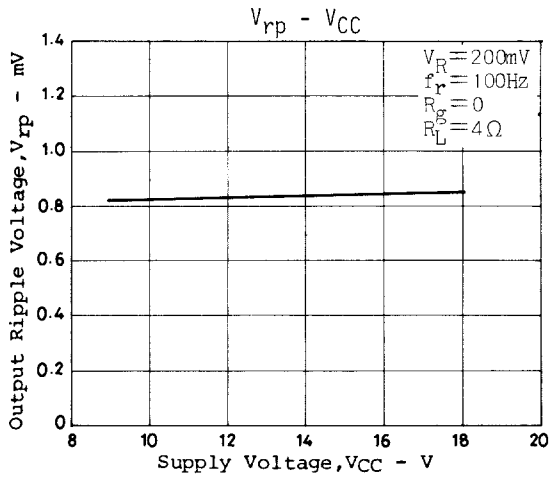

Proper Cares in Mounging Radiator Fin

1. The mounting torque is in the range of 39 to 59N · cm.
2. The distance between screw holes of the radiator fin must coincide with the distance between screw holes of the IC. With case outline dimensions L and R referred to, the screws must be tightened with the distance between them as close to each other as possible.

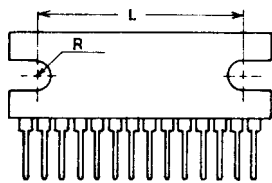

3. The screw to be used must have a head equivalent to the one of truss machine screw or binder machine screw defined by JIS. Washers must be also used to protect the IC case.
4. No foreign matter such as cutting particles shall exist between heat sink and radiator fin. When applying grease on the junction surface, it must be applied uniformly on the whole surface.
5. IC lead pins are soldered to the printed circuit board after the radiator fin is mounted on the IC.

- Specifications of any and all SANYO products described or contained herein stipulate the performance, characteristics, and functions of the described products in the independent state, and are not guarantees of the performance, characteristics, and functions of the described products as mounted in the customer's products or equipment. To verify symptoms and states that cannot be evaluated in an independent device, the customer should always evaluate and test devices mounted in the customer's products or equipment.
- SANYO Electric Co., Ltd. strives to supply high-quality high-reliability products. However, any and all semiconductor products fail with some probability. It is possible that these probabilistic failures could give rise to accidents or events that could endanger human lives, that could give rise to smoke or fire, or that could cause damage to other property. When designing equipment, adopt safety measures so that these kinds of accidents or events cannot occur. Such measures include but are not limited to protective circuits and error prevention circuits for safe design, redundant design, and structural design.
- In the event that any or all SANYO products(including technical data, services) described or contained herein are controlled under any of applicable local export control laws and regulations, such products must not be exported without obtaining the export license from the authorities concerned in accordance with the above law.
- No part of this publication may be reproduced or transmitted in any form or by any means, electronic or mechanical, including photocopying and recording, or any information storage or retrieval system, or otherwise, without the prior written permission of SANYO Electric Co., Ltd.
- Any and all information described or contained herein are subject to change without notice due to product/technology improvement, etc. When designing equipment, refer to the "Delivery Specification" for the SANYO product that you intend to use.
- Information (including circuit diagrams and circuit parameters) herein is for example only ; it is not guaranteed for volume production. SANYO believes information herein is accurate and reliable, but no guarantees are made or implied regarding its use or any infringements of intellectual property rights or other rights of third parties.

This catalog provides information as of February, 2000. Specifications and information herein are subject to change without notice.



Компания «ЭлектроПласт» предлагает заключение долгосрочных отношений при поставках импортных электронных компонентов на взаимовыгодных условиях!

Наши преимущества:

- Оперативные поставки широкого спектра электронных компонентов отечественного и импортного производства напрямую от производителей и с крупнейших мировых складов;
- Поставка более 17-ти миллионов наименований электронных компонентов;
- Поставка сложных, дефицитных, либо снятых с производства позиций;
- Оперативные сроки поставки под заказ (от 5 рабочих дней);
- Экспресс доставка в любую точку России;
- Техническая поддержка проекта, помощь в подборе аналогов, поставка прототипов;
- Система менеджмента качества сертифицирована по Международному стандарту ISO 9001;
- Лицензия ФСБ на осуществление работ с использованием сведений, составляющих государственную тайну;
- Поставка специализированных компонентов (Xilinx, Altera, Analog Devices, Intersil, Interpoint, Microsemi, Aeroflex, Peregrine, Syfer, Eurofarad, Texas Instrument, Miteq, Cobham, E2V, MA-COM, Hittite, Mini-Circuits, General Dynamics и др.);

Помимо этого, одним из направлений компании «ЭлектроПласт» является направление «Источники питания». Мы предлагаем Вам помощь Конструкторского отдела:

- Подбор оптимального решения, техническое обоснование при выборе компонента;
- Подбор аналогов;
- Консультации по применению компонента;
- Поставка образцов и прототипов;
- Техническая поддержка проекта;
- Защита от снятия компонента с производства.



Как с нами связаться

Телефон: 8 (812) 309 58 32 (многоканальный)

Факс: 8 (812) 320-02-42

Электронная почта: org@eplast1.ru

Адрес: 198099, г. Санкт-Петербург, ул. Калинина, дом 2, корпус 4, литера А.