

## STRADELLA-CY

Beam for canopy lighting with batwing light distribution. Suitable for symmetrical tunnel lighting.

### TECHNICAL SPECIFICATIONS:

|                |         |
|----------------|---------|
| Dimensions     | 13.9 mm |
| Height         | 4.7 mm  |
| Fastening      | pin     |
| ROHS compliant | yes ⓘ   |

### MATERIAL SPECIFICATIONS:

| Component    | Type        | Material | Colour | Finish |
|--------------|-------------|----------|--------|--------|
| STRADELLA-CY | Single lens | PMMA     | clear  |        |

### ORDERING INFORMATION:

| Component   | Qty in box | MOQ  | MPQ  | Box weight (kg) |
|---|------------|------|------|-----------------|
| C15437_STRADELLA-CY<br>» Box size: 480 x 250 x 390 mm | 16000      | 1000 | 1000 | 7.3             |



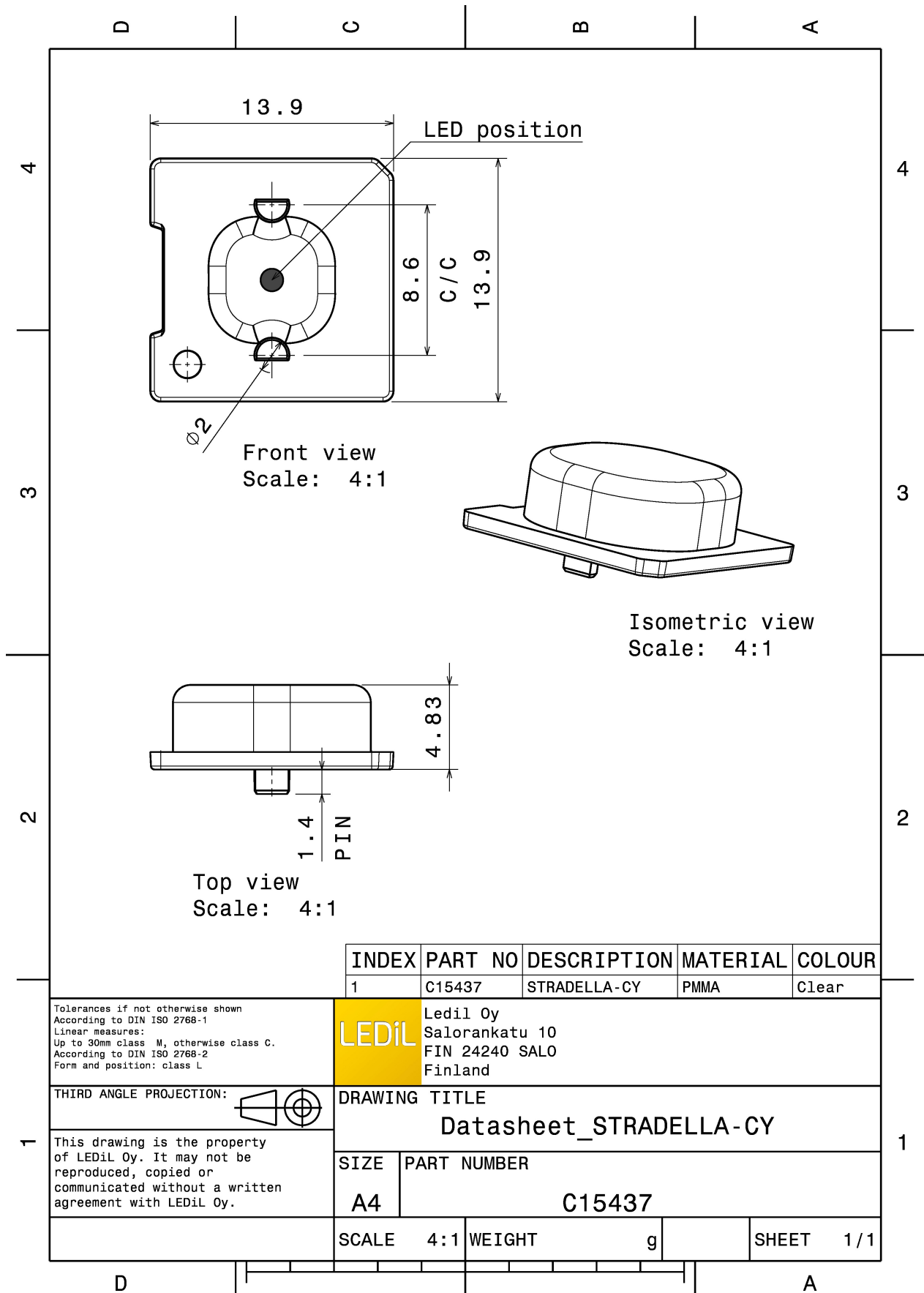

| INDEX | PART NO | DESCRIPTION  | MATERIAL | COLOUR |
|-------|---------|--------------|----------|--------|
| 1     | C15437  | STRADELLA-CY | PMMA     | Clear  |

Tolerances if not otherwise shown  
According to DIN ISO 2768-1  
Linear measures:  
Up to 30mm class M, otherwise class C.  
According to DIN ISO 2768-2  
Form and position: class L



Ledil Oy  
Salorankatu 10  
FIN 24240 SALO  
Finland

THIRD ANGLE PROJECTION:

DRAWING TITLE  
**Datasheet\_STRADELLA-CY**

This drawing is the property of LEDiL Oy. It may not be reproduced, copied or communicated without a written agreement with LEDiL Oy.

| SIZE | PART NUMBER |
|------|-------------|
| A4   | C15437      |

| SCALE | 4:1 | WEIGHT | g | SHEET | 1/1 |
|-------|-----|--------|---|-------|-----|
|-------|-----|--------|---|-------|-----|

#### PHOTOMETRIC DATA (MEASURED):

#### CREE

LED XT-E  
 FWHM 115.0°  
 Efficiency 94 %  
 Peak intensity 0.3 cd/lm  
 LEDs/each optic 1  
 Light colour White  
 Required components:

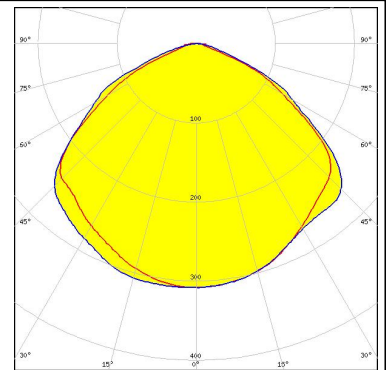

#### NICHIA

LED NVSW219D  
 FWHM 114.0°  
 Efficiency 94 %  
 Peak intensity 0.4 cd/lm  
 LEDs/each optic 1  
 Light colour White  
 Required components:

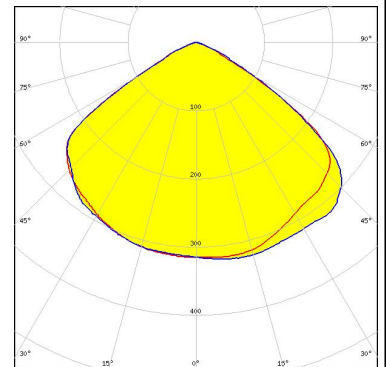
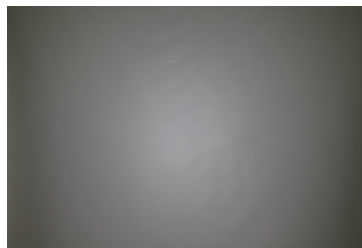

#### NICHIA

LED NVSW319B  
 FWHM Asymmetric  
 Efficiency 94 %  
 Peak intensity 0.4 cd/lm  
 LEDs/each optic 1  
 Light colour White  
 Required components:

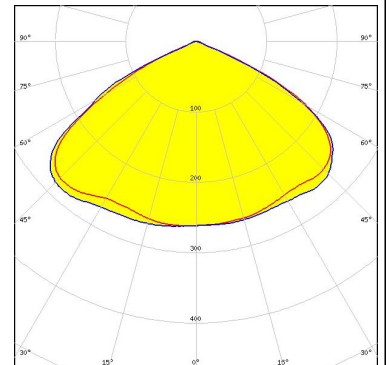

#### SAMSUNG

LED LH181B  
 FWHM 116.0°  
 Efficiency 94 %  
 Peak intensity 0.4 cd/lm  
 LEDs/each optic 1  
 Light colour White  
 Required components:

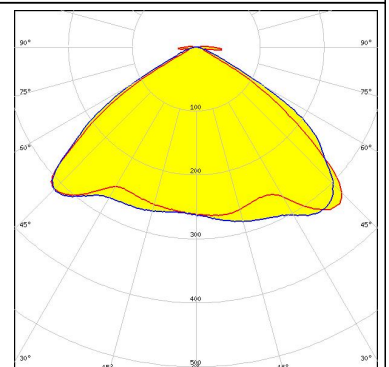

### PHOTOMETRIC DATA (SIMULATED):



LED XP-E2  
FWHM 117.0°  
Efficiency 90 %  
Peak intensity 0.4 cd/lm  
LEDs/each optic 1  
Light colour White  
Required components:

Transparent protective cover

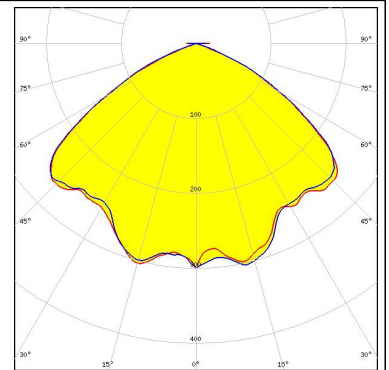

LED XP-G2 HE  
FWHM 121.0°  
Efficiency 95 %  
Peak intensity 0.3 cd/lm  
LEDs/each optic 1  
Light colour White  
Required components:

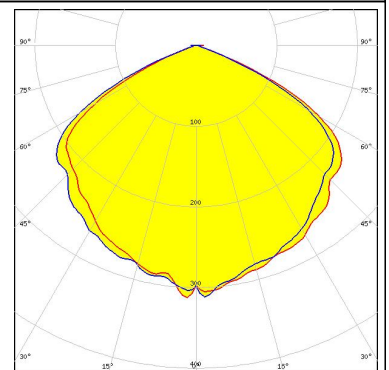

LED LUXEON IR Domed 150  
FWHM 133.0°  
Efficiency 94 %  
LEDs/each optic 1  
Light colour White  
Required components:



LED OSCONIQ P 3030  
FWHM 112.0°  
Efficiency 96 %  
Peak intensity 0.4 cd/lm  
LEDs/each optic 1  
Light colour White  
Required components:

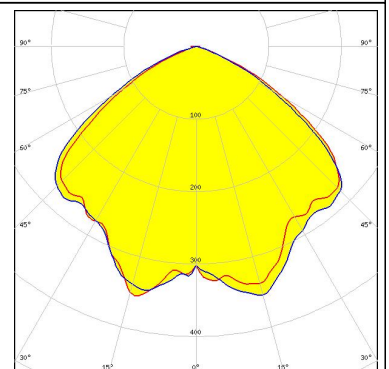

#### PHOTOMETRIC DATA (SIMULATED):

#### OSRAM

Opto Semiconductors

LED OSCONIQ P 3737 (2W version)  
 FWHM 115.0°  
 Efficiency 94 %  
 Peak intensity 0.4 cd/lm  
 LEDs/each optic 1  
 Light colour White  
 Required components:

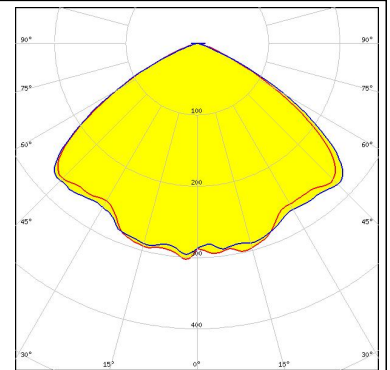

#### OSRAM

Opto Semiconductors

LED OSCONIQ P 3737 (3W version)  
 FWHM 117.0°  
 Efficiency 96 %  
 Peak intensity 0.3 cd/lm  
 LEDs/each optic 1  
 Light colour White  
 Required components:

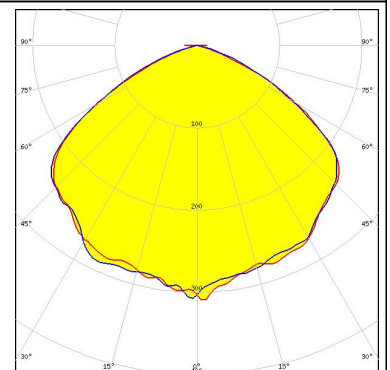

#### OSRAM

Opto Semiconductors

LED OSLON Square CSSRM2/CSSRM3  
 FWHM 120.0°  
 Efficiency 96 %  
 Peak intensity 0.3 cd/lm  
 LEDs/each optic 1  
 Light colour White  
 Required components:

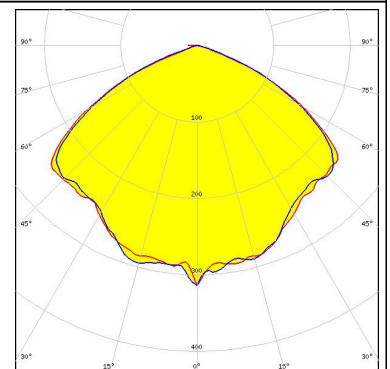

#### SAMSUNG

LED LH351B  
 FWHM 110.0°  
 Efficiency 92 %  
 Peak intensity 0.3 cd/lm  
 LEDs/each optic 1  
 Light colour White  
 Required components:

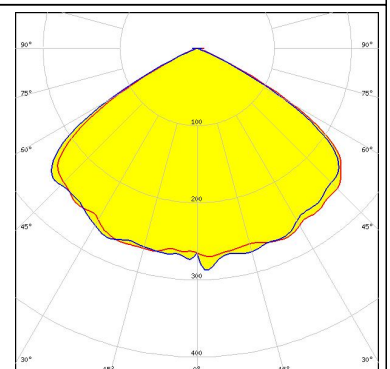

**PHOTOMETRIC DATA (SIMULATED):**

## SAMSUNG

LED LH351D  
 FWHM 123.0°  
 Efficiency 94 %  
 Peak intensity 0.3 cd/lm  
 LEDs/each optic 1  
 Light colour White  
 Required components:

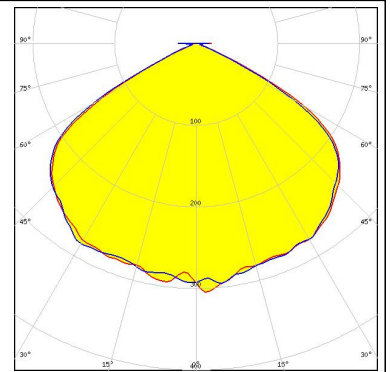

SEOUL SEMICONDUCTOR

LED SEOUL DC 5050 6V  
 FWHM 114.0°  
 Efficiency 94 %  
 Peak intensity 0.3 cd/lm  
 LEDs/each optic 1  
 Light colour White  
 Required components:

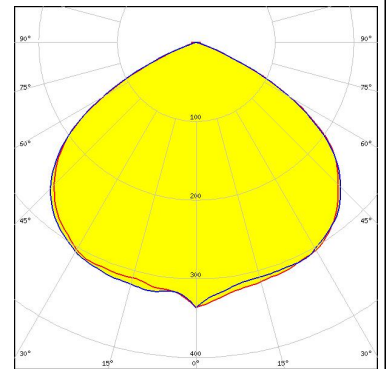

SEOUL SEMICONDUCTOR

LED Z5M1/Z5M2  
 FWHM 118.0°  
 Efficiency 96 %  
 Peak intensity 0.4 cd/lm  
 LEDs/each optic 1  
 Light colour White  
 Required components:

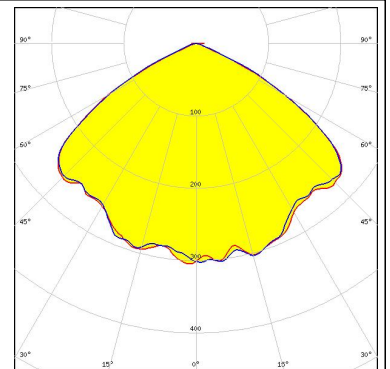

#### GENERAL INFORMATION:

NOTE: The typical beam angle will be changed by different color, chip size and chip position tolerance. The typical total beam angle is the full angle measured where the luminous intensity is half of the peak value.

#### MATERIALS:

As part of our continuous research and improvement processes, and to ensure the best possible quality and availability of our products, LEDiL reserves the right to change material grades without notice.

#### PRODUCT DATA USER AGREEMENT AND DISCLAIMER:

The measured data in the provided downloadable LEDiL Product Datasheets and Mechanical 2D-Drawings is rounded and provided as reference for planning. LEDiL Oy's optical specifications have been verified by conducting performance testing of the products in accordance with the company's quality system. The reported data are averaged results of multiple measurements with typical variation. LEDiL Oy reserves the right to without prior notification make changes and improvements to its products.

LEDiL Oy assumes neither warranty, nor guarantee nor any other liability of any kind for the contents and correctness of the provided data. The provided data has been generated with highest diligence but the provided data may in reality not represent the complete possible variation range of all intrinsic parameters. Therefore, in certain cases a deviation from the provided data could occur.

LEDiL Oy reserves the right to undertake technical changes of its products without further notification which could lead to changes in the provided data. LEDiL Oy assumes no liability of any kind for the possible deviation from any provided data or any other damage resulting from the usage of the provided data.

The user agrees to this disclaimer and user agreement with the download or usage of the provided files.

#### LEDiL Oy

Joensuunkatu 13  
FI-24240 SALO  
Finland

#### LEDiL Inc.

228 West Page Street  
Suite D  
Sycamore IL 60178  
USA

#### Local sales and technical support

[www.ledil.com/  
where\\_to\\_buy](http://www.ledil.com/where_to_buy)

#### Shipping locations

Salo, Finland  
Hong Kong, China

#### Distribution Partners

[www.ledil.com/  
where\\_to\\_buy](http://www.ledil.com/where_to_buy)



Компания «ЭлектроПласт» предлагает заключение долгосрочных отношений при поставках импортных электронных компонентов на взаимовыгодных условиях!

Наши преимущества:

- Оперативные поставки широкого спектра электронных компонентов отечественного и импортного производства напрямую от производителей и с крупнейших мировых складов;
- Поставка более 17-ти миллионов наименований электронных компонентов;
- Поставка сложных, дефицитных, либо снятых с производства позиций;
- Оперативные сроки поставки под заказ (от 5 рабочих дней);
- Экспресс доставка в любую точку России;
- Техническая поддержка проекта, помощь в подборе аналогов, поставка прототипов;
- Система менеджмента качества сертифицирована по Международному стандарту ISO 9001;
- Лицензия ФСБ на осуществление работ с использованием сведений, составляющих государственную тайну;
- Поставка специализированных компонентов (Xilinx, Altera, Analog Devices, Intersil, Interpoint, Microsemi, Aeroflex, Peregrine, Syfer, Eurofarad, Texas Instrument, Miteq, Cobham, E2V, MA-COM, Hittite, Mini-Circuits, General Dynamics и др.);

Помимо этого, одним из направлений компании «ЭлектроПласт» является направление «Источники питания». Мы предлагаем Вам помощь Конструкторского отдела:

- Подбор оптимального решения, техническое обоснование при выборе компонента;
- Подбор аналогов;
- Консультации по применению компонента;
- Поставка образцов и прототипов;
- Техническая поддержка проекта;
- Защита от снятия компонента с производства.



#### Как с нами связаться

**Телефон:** 8 (812) 309 58 32 (многоканальный)

**Факс:** 8 (812) 320-02-42

**Электронная почта:** [org@eplast1.ru](mailto:org@eplast1.ru)

**Адрес:** 198099, г. Санкт-Петербург, ул. Калинина, дом 2, корпус 4, литера А.