

AT-283-PIN

Digital Attenuator
15.5 dB, 5-Bit, TTL Driver, DC-2.0 GHz

Rev. V7

Features

- Attenuation: 0.5 dB Steps to 15.5 dB
- Temperature Stability: ± 0.18 dB from -55°C to $+85^{\circ}\text{C}$ Typical
- Low DC Power Consumption
- Hermetic Surface Mount Package
- Integral TTL Driver
- $50\ \Omega$ Nominal Impedance
- Lead-Free CR-12 Package
- 260°C Reflow Compatible
- RoHS* Compliant

Description

M/A-COM's AT-283-PIN is a GaAs FET 5-bit digital attenuator with a 0.5 dB minimum step size and 15.5 dB total attenuation. This attenuator and integral TTL driver is in a hermetically sealed ceramic 16 lead surface mount package. The AT-283-PIN is ideally suited for use where accuracy, fast switching, very low power consumption and low intermodulation products are required. Typical applications include dynamic range setting in precision receiver circuits and other gain/leveling control circuits. Environmental screening is available. Contact the factory for information.

Ordering Information

| Part Number | Package |
|--------------------|-------------------|
| AT-283-PIN | Bulk Packaging |
| MAAD-007229-0001TR | 1000 piece reel |
| MAAD-007229-0001TB | Sample Test Board |

Note: Reference Application Note M513 for reel size information.

Functional Schematic

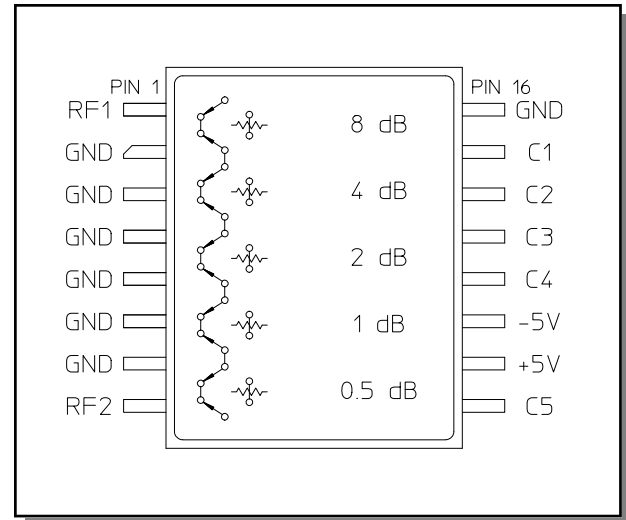

Pin Configuration

| Pin No. | Function | Pin No. | Function |
|---------|----------|---------|----------|
| 1 | RF1 | 9 | C5 |
| 2 | GND | 10 | +5V |
| 3 | GND | 11 | -5V |
| 4 | GND | 12 | C4 |
| 5 | GND | 13 | C3 |
| 6 | GND | 14 | C2 |
| 7 | GND | 15 | C1 |
| 8 | RF2 | 16 | GND |

The metal bottom of the case must be connected to RF and DC ground.

* Restrictions on Hazardous Substances, European Union Directive 2002/95/EC.

Electrical Specifications: $T_A = 25^\circ\text{C}^1$

| Parameter | Test Conditions | Units | Min | Typ | Max |
|---|---|--------------------------|---|------------|--------|
| Reference Insertion Loss | DC-0.5 GHz | dB | — | — | 2.2 |
| | DC-1.0 GHz | dB | — | — | 2.5 |
| | DC-2.0 GHz | dB | — | — | 2.9 |
| Attenuation Accuracy ² | Any Single Bit Any Combination of Bits | DC-2.0 GHz DC-2.0 GHz | ± (0.25 +3% of attenuation setting in dB) dB ± (0.25 +3% of attenuation setting in dB) dB or ± 0.4 dB, whichever is greater | | |
| VSWR | DC-1.0 GHz | — | — | — | 1.6:1 |
| | DC-2.0 GHz | — | — | — | 1.7:1 |
| Trise, Tfall Ton, Toff Transients | 10% to 90% | nS | — | 10 | — |
| | 50% Control to 90/10% RF | nS | — | 27 | — |
| | In-band (peak—peak) | mV | — | 22 | — |
| 1 dB Compression ³ | Input Power | 0.05 GHz | — | +20 | — |
| | Input Power | 0.5-2.0 GHz | — | +28 | — |
| Input IP ₃ ³ | For two-tone input power up to +5 dBm | 0.05 GHz 0.5-2.0 GHz | — — | +40 +47 | — — |
| | For two-tone input power up to +5 dBm | 0.05 GHz 0.5-2.0 GHz | — — | +53 +68 | — — |
| V _{CC} V _{EE} | — | V | 4.5 | 5.0 | 5.5 |
| | — | V | -8.0 | — | -5.0 |
| I _{CC} | V _{CC} = 4.5 to 5.5V V _{ctl} = 0 to 0.8V, or V _{CC} - 2.1V to V _{CC} | mA | — | — | 5.0 |
| I _{EE} | V _{EE} = -5.0 to -8.0V | mA | — | — | 1.0 |
| V _{ctl} V _{cti} | Logic 0 (TTL) | V | 0.0 | — | 0.8 |
| | Logic 1 (TTL) | V | 2.0 | — | 5.0 |
| Input Leakage Current (Low) | 0 to 0.8V | µA | — | — | 1.0 |
| Input Leakage Current (High) | 2.0 to 5.0V | µA | — | — | 1.0 |

1. All specifications apply when operated with bias voltages of +5.0V for V_{CC} and -5.0V to -8.0V for V_{EE}, and 50 Ω impedance at all ports unless otherwise specified.
2. This attenuator is guaranteed monotonic.
3. V_{EE} = -5.0V for the typical numbers given.

Absolute Maximum Ratings ^{4,5}

| Parameter | Absolute Maximum |
|--|---|
| Maximum Input Power 0.05 GHz 0.5-2.0 GHz | +27 dBm +34 dBm |
| V_{CC} | $-0.5V \leq V_{CC} \leq +7.0V$ |
| V_{EE} | $-8.5V \leq V_{EE} \leq +0.5V$ |
| $V_{CC} - V_{EE}$ | $-0.5V \leq V_{CC} - V_{EE} \leq 14.5V$ |
| V_{in}^6 | $-0.5V \leq V_{in} \leq V_{CC} + 0.5V$ |
| Operating Temperature | $-55^{\circ}C$ to $+125^{\circ}C$ |
| Storage Temperature | $-65^{\circ}C$ to $+150^{\circ}C$ |

- Exceeding any one or combination of these limits may cause permanent damage to this device.
- M/A-COM does not recommend sustained operation near these survivability limits.
- Standard CMOS TTL interface, latch-up will occur if logic signal is applied prior to power supply.

Handling Procedures

Please observe the following precautions to avoid damage:

Static Sensitivity

Gallium Arsenide Integrated Circuits are sensitive to electrostatic discharge (ESD) and can be damaged by static electricity. Proper ESD control techniques should be used when handling these devices.

Typical Performance Curves

Reference Insertion Loss vs. Frequency @ Temperature

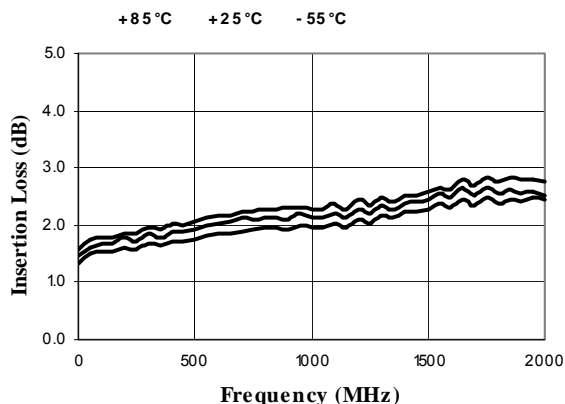

Recommended PCB Configuration

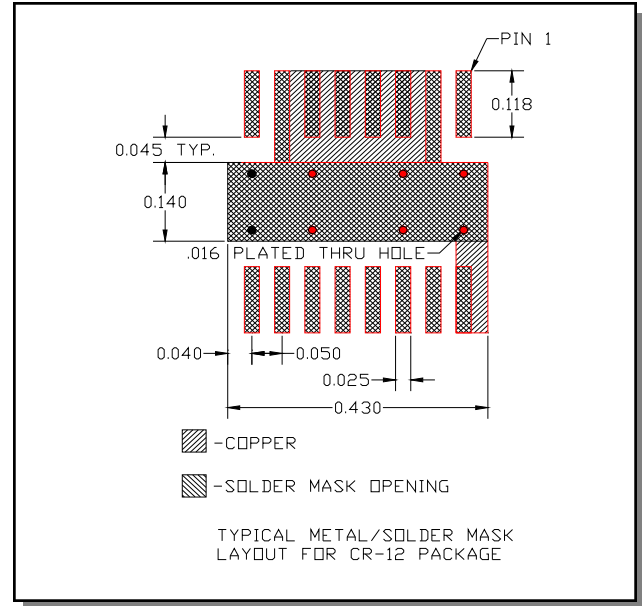

Truth Table (Digital Attenuator)

| Control Inputs | | | | | |
|----------------|----|----|----|----|-------------|
| C1 | C2 | C3 | C4 | C5 | Attenuation |
| 0 | 0 | 0 | 0 | 0 | Reference |
| 1 | 0 | 0 | 0 | 0 | 0.5 dB |
| 0 | 1 | 0 | 0 | 0 | 1 dB |
| 0 | 0 | 1 | 0 | 0 | 2 dB |
| 0 | 0 | 0 | 1 | 0 | 4 dB |
| 0 | 0 | 0 | 0 | 1 | 8 dB |
| 1 | 1 | 1 | 1 | 1 | 15.5 dB |

0 = TTL Low; 1 = TTL High

Attenuation Accuracy vs. Frequency 0.5, 1, 2 dB Bits

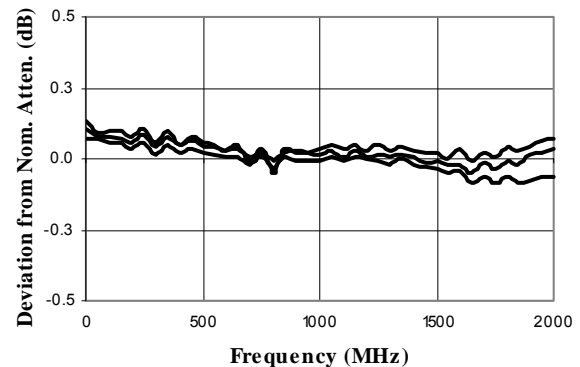

AT-283-PIN

Digital Attenuator
15.5 dB, 5-Bit, TTL Driver, DC-2.0 GHz

Rev. V7

Typical Performance Curves

Attenuation Accuracy vs. Frequency 4, 8 dB Bits and Full Attenuation

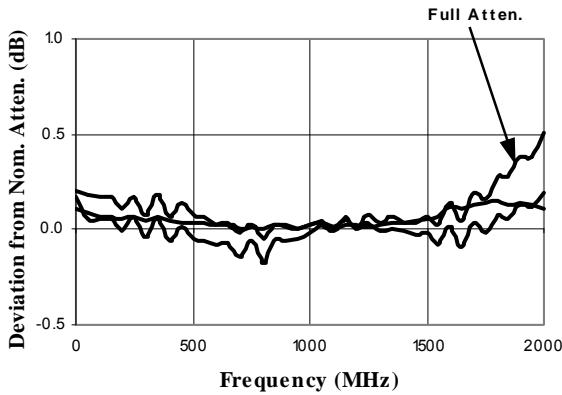

VSWR vs. Frequency Reference Loss, 0.5, 1, 2 dB Bits

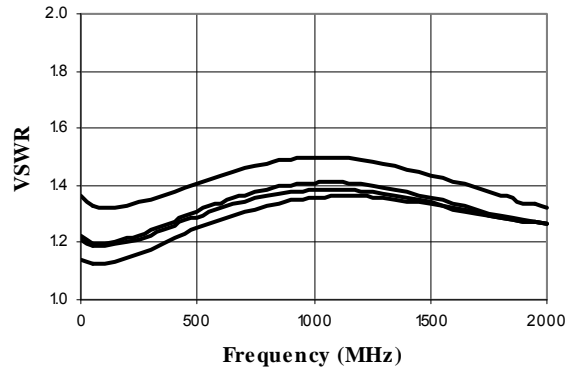

VSWR vs. Frequency 4, 8 dB Bits and Full Attenuation

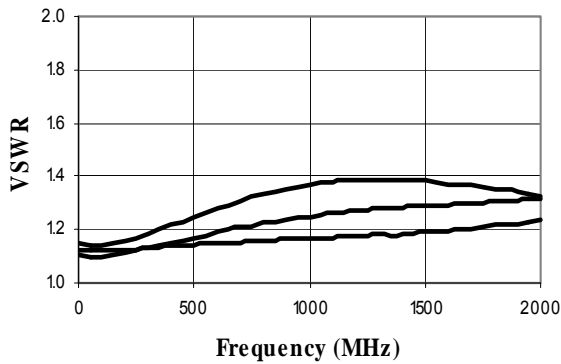

Lead-Free, CR-12 Ceramic Package[†]

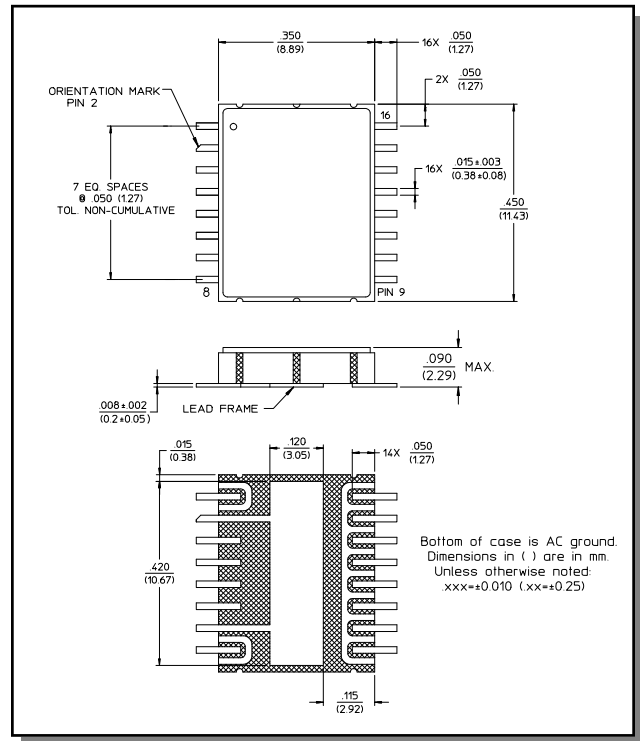

[†] Reference Application Note M538 for lead-free solder reflow recommendations.



Компания «ЭлектроПласт» предлагает заключение долгосрочных отношений при поставках импортных электронных компонентов на взаимовыгодных условиях!

Наши преимущества:

- Оперативные поставки широкого спектра электронных компонентов отечественного и импортного производства напрямую от производителей и с крупнейших мировых складов;
- Поставка более 17-ти миллионов наименований электронных компонентов;
- Поставка сложных, дефицитных, либо снятых с производства позиций;
- Оперативные сроки поставки под заказ (от 5 рабочих дней);
- Экспресс доставка в любую точку России;
- Техническая поддержка проекта, помощь в подборе аналогов, поставка прототипов;
- Система менеджмента качества сертифицирована по Международному стандарту ISO 9001;
- Лицензия ФСБ на осуществление работ с использованием сведений, составляющих государственную тайну;
- Поставка специализированных компонентов (Xilinx, Altera, Analog Devices, Intersil, Interpoint, Microsemi, Aeroflex, Peregrine, Syfer, Eurofarad, Texas Instrument, Miteq, Cobham, E2V, MA-COM, Hittite, Mini-Circuits, General Dynamics и др.);

Помимо этого, одним из направлений компании «ЭлектроПласт» является направление «Источники питания». Мы предлагаем Вам помощь Конструкторского отдела:

- Подбор оптимального решения, техническое обоснование при выборе компонента;
- Подбор аналогов;
- Консультации по применению компонента;
- Поставка образцов и прототипов;
- Техническая поддержка проекта;
- Защита от снятия компонента с производства.



Как с нами связаться

Телефон: 8 (812) 309 58 32 (многоканальный)

Факс: 8 (812) 320-02-42

Электронная почта: org@eplast1.ru

Адрес: 198099, г. Санкт-Петербург, ул. Калинина, дом 2, корпус 4, литера А.