

LOC		DIST		REVISIONS			
P	LR	DESCRIPTION	DATE	DWN	APVD	REV	AA2
AD	00	AA2	REVISED PER ECO-11-004917	11MAR11	RK	HMR	

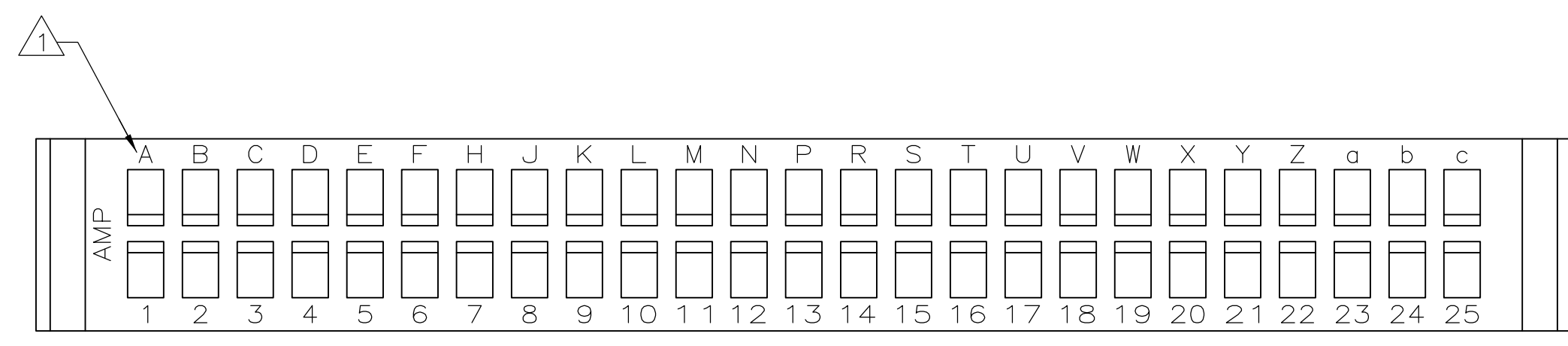

THIS DRAWING IS A CONTROLLED DOCUMENT FOR AMP INCORPORATED. IT IS SUBJECT TO CHANGE AND THE CONTROLLING ENGINEERING ORGANIZATION SHOULD BE CONTACTED FOR THE LATEST REVISION.

THIS DRAWING IS A CONTROLLED DOCUMENT.		DWN: J. GALLUCCI BG 12-10-92		CHK: H. ROSE 2/18/94		APVD: H. ROSE 2/18/94		NAME: H. ROSE		PRODUCT SPEC: PRODUCT SPEC		APPLICATION SPEC: APPLICATION SPEC		WEIGHT: WEIGHT		SIZE: A1		CAGE CODE: 00779		DRAWING NO: C=583717		RESTRICTED TO: REV: AA2			
DIMENSIONS: MM(INCHES)		TOLERANCES UNLESS OTHERWISE SPECIFIED:		0 PLC ± -		1 PLC ± -		2 PLC ± -		3 PLC ± 0.13(.005)		4 PLC ± -		ANGLES ± -		FINISH: -		MATERIAL: GLASS FILLED POLYESTER		COLOR: BLACK		SCALE: 4:1		SHEET: 1 OF 2	
CUSTOMER DRAWING												SCALE: 4:1		SHEET: 1 OF 2		REV: AA2									

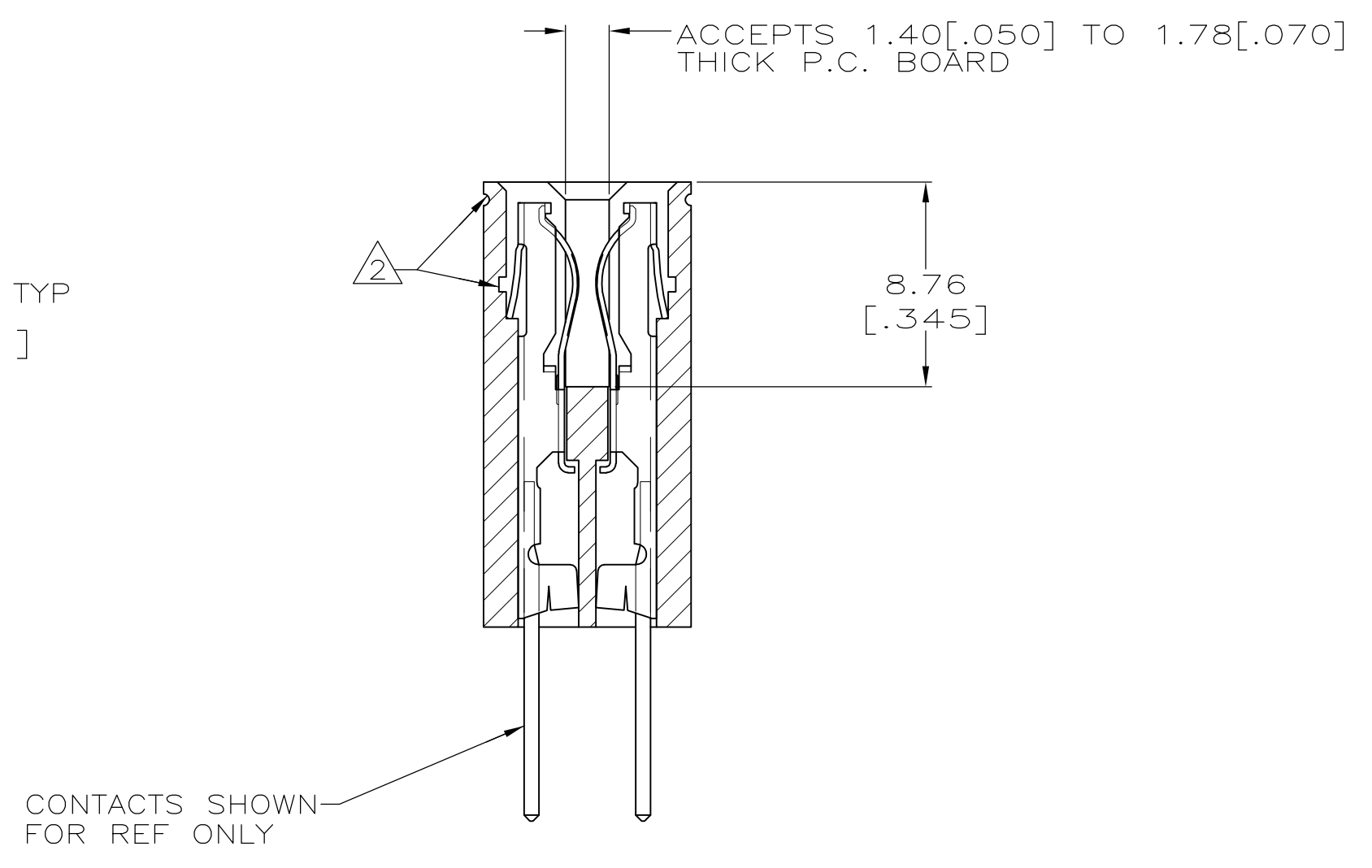
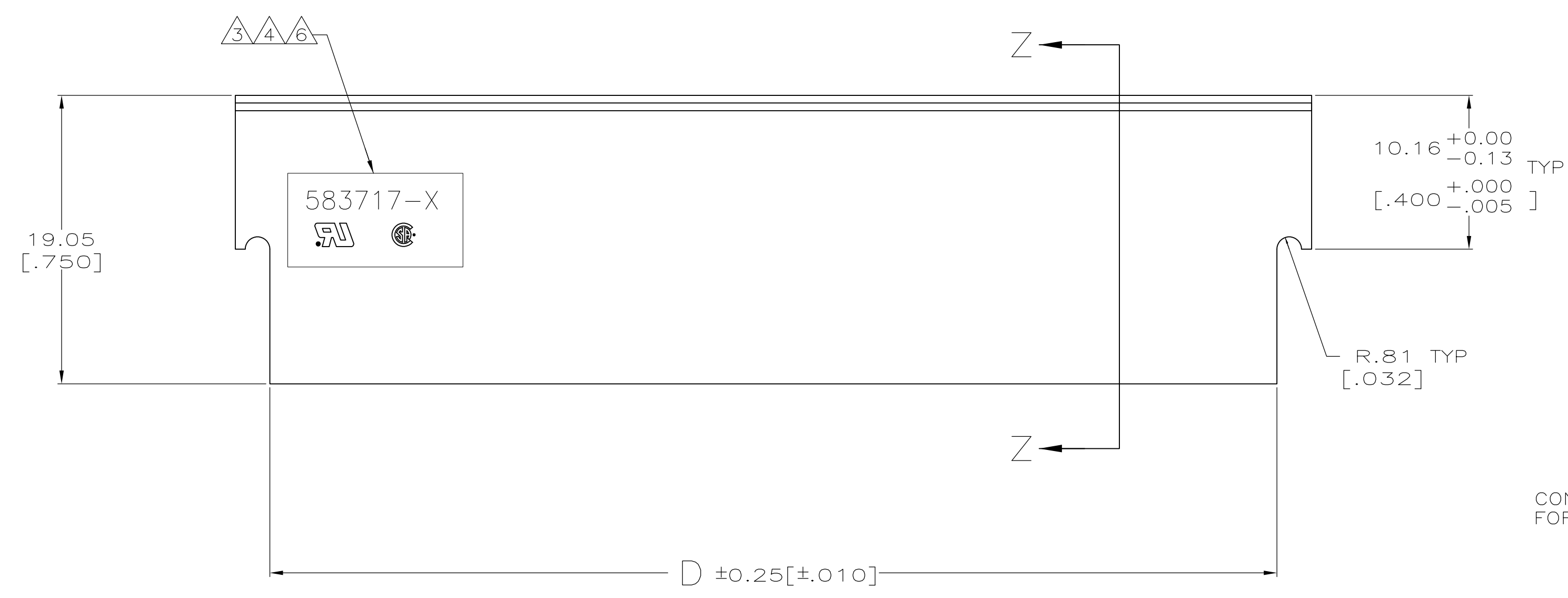
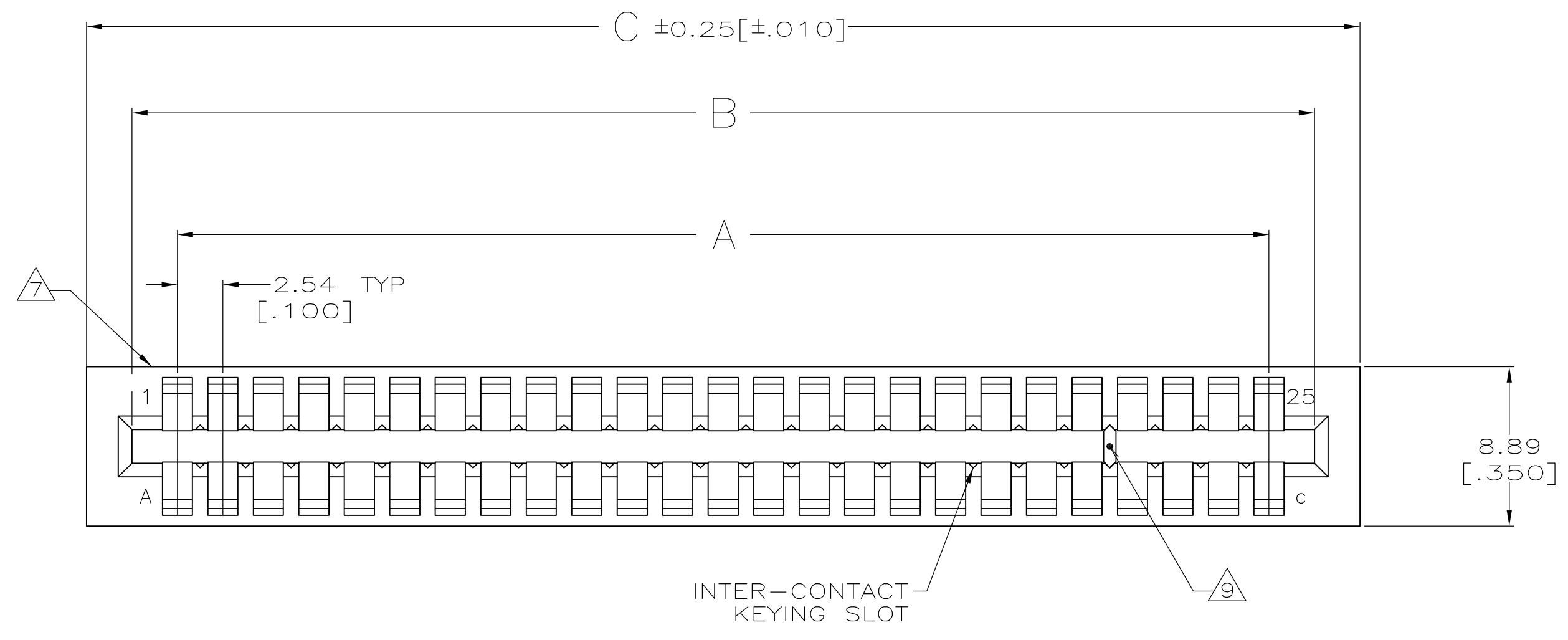
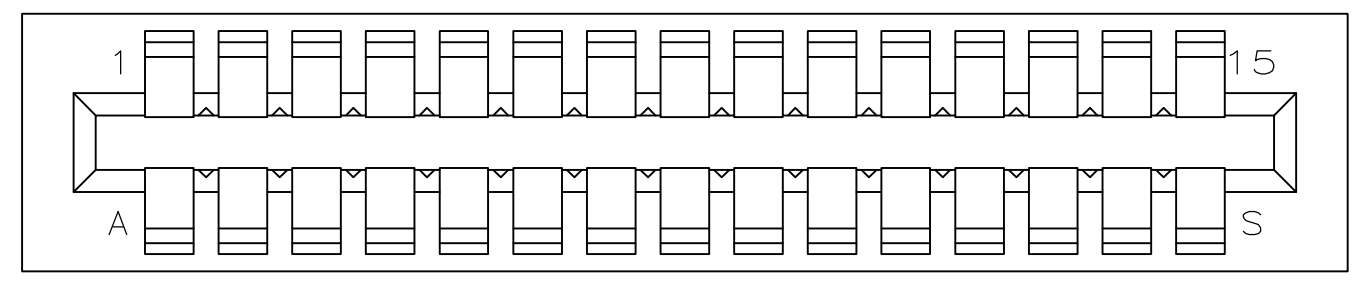
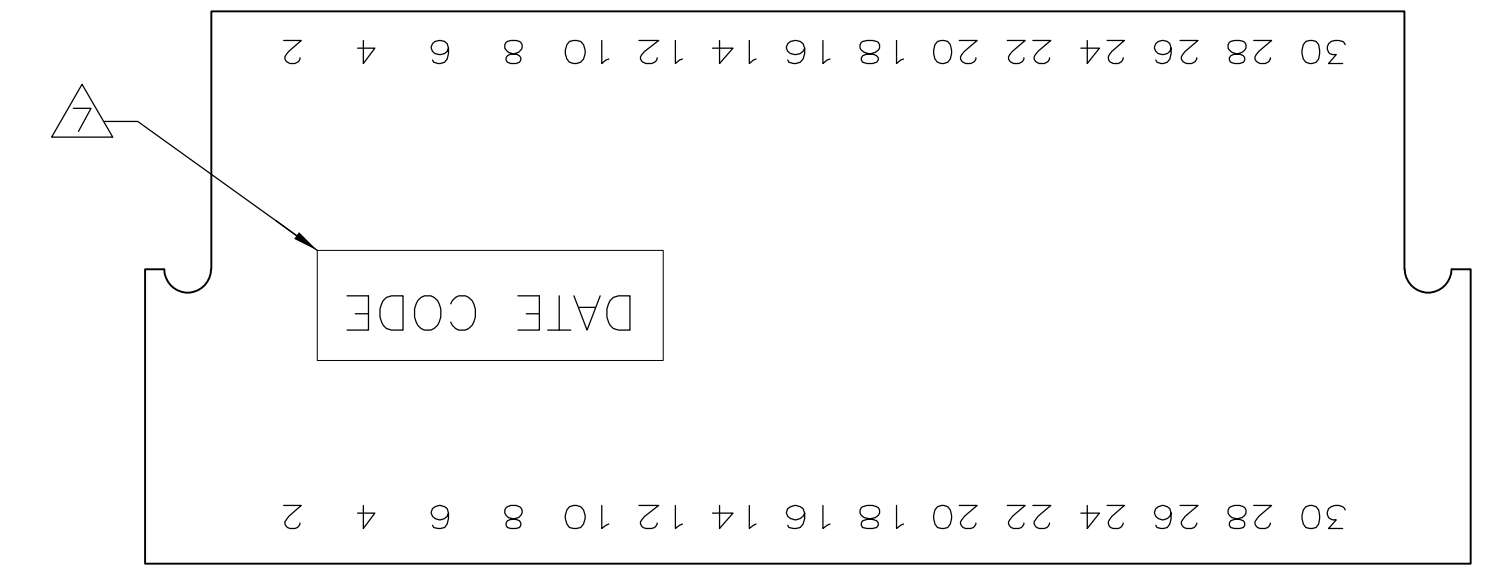

3-583717-4

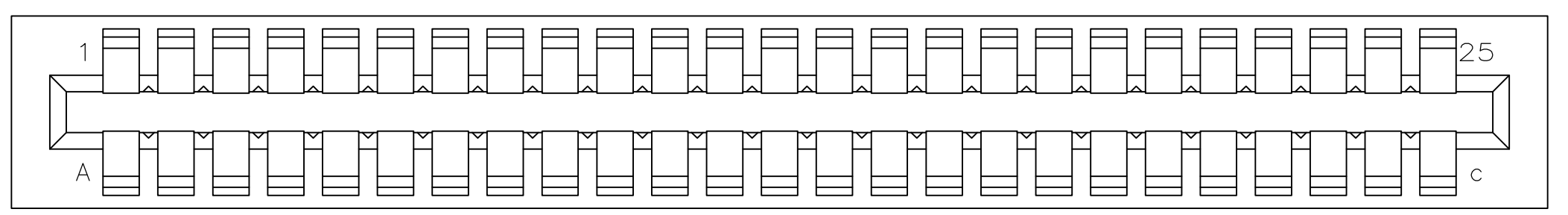
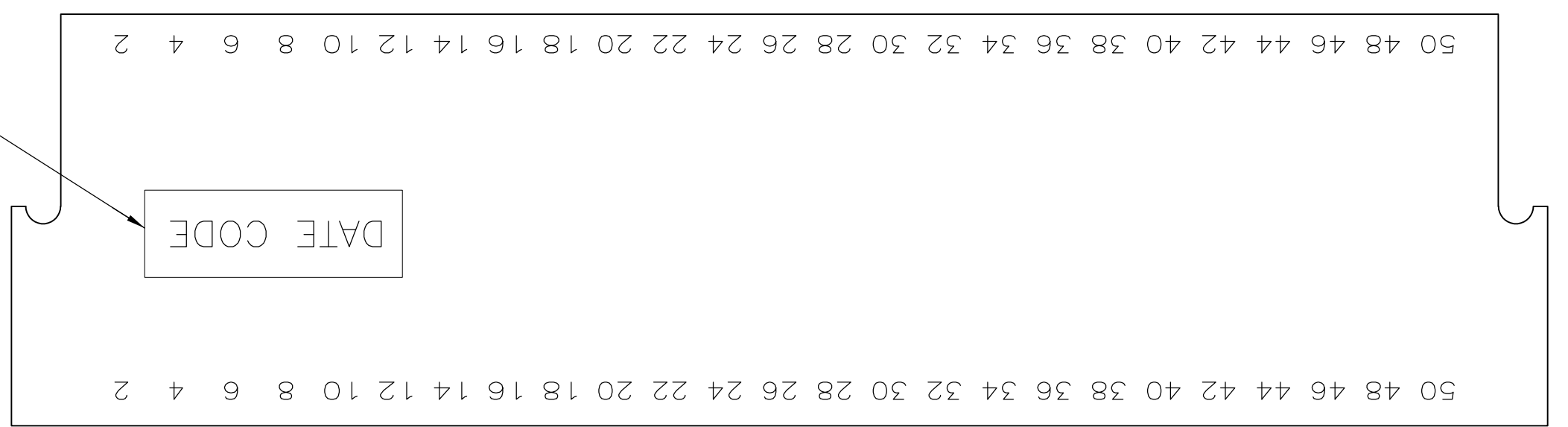
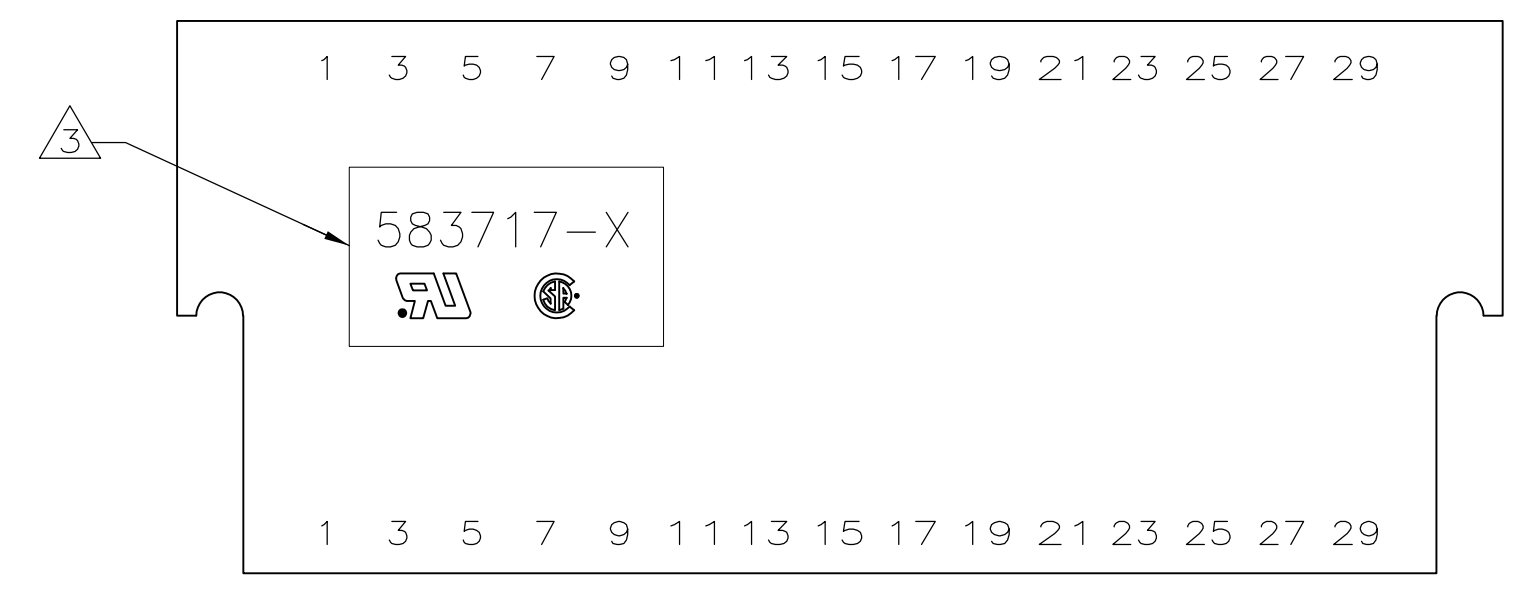

3-583717-5



- ① FIRST 22 POSITIONS MARKED WITH UPPER CASE LETTERS, FOLLOWED BY LOWER CASE LETTERS, FOLLOWED BY UPPERCASE AA,AB,AC ETC. CHARACTERS G,I,O AND Q ARE OMITTED. SEE TABLE FOR END CAVITY IDENTIFICATION.
- ② OPTIONAL PULL GROOVES. THE PULL GROOVE LENGTH, SIZE AND LOCATION ARE AT THE DISCRETION OF THE MOLD VENDOR.
- ③ HOUSING PART NUMBER, UL & CSA LOGO'S TO BE MOLDED IN THIS AREA. UL, LOGO PER 1-18838-3, CSA LOGO PER 1-18839-3.
- ④ HOT STAMP CUSTOMER PART NUMBER 2571 0880 FOR 2-583717-9 ONLY.
- ⑤ HOT STAMP CUSTOMER PART NUMBER 655862-2 IN THIS AREA.
- ⑥ DATE CODE TO BE MOLDED IN THIS AREA
- ⑦ MOLDED KEYING PLUG LOCATED BETWEEN CIRCUITS 25 AND 26 FOR PART NUMBER 4-583717-6 ONLY.
- ⑧ PRELIMINARY - NOT RELEASED FOR PRODUCTION.

⑨	3 & C	10.67 [.420]	15.24 [.600]	10.16 [.400]	5.08 [.200]	3	4-583717-8
⑨	23 & A	61.47 [2.420]	66.04 [2.600]	60.96 [2.400]	55.88 [2.200]	23	4-583717-7
⑧⑨	30 & J	79.25 [3.120]	83.82 [3.300]	78.74 [3.100]	73.66 [2.900]	30	4-583717-6
⑨	27 & E	71.63 [2.820]	76.20 [3.000]	71.12 [2.800]	66.04 [2.600]	27	4-583717-5
	8 & J	23.37 [.920]	27.94 [1.100]	22.86 [.900]	17.78 [.700]	8	3-583717-9
⑥	OBSOLETE	36.07 [1.420]	40.64 [1.600]	35.56 [1.400]	30.48 [1.200]	13	3-583717-8
⑤	OBSOLETE	66.55 [2.620]	71.12 [2.800]	66.04 [2.600]	60.96 [2.400]	25	3-583717-5
⑤	OBSOLETE	41.15 [1.620]	45.72 [1.800]	40.64 [1.600]	35.56 [1.400]	15	3-583717-4
	13 & P	36.07 [1.420]	40.64 [1.600]	35.56 [1.400]	30.48 [1.200]	13	3-583717-3
	20 & X	53.85 [2.120]	58.42 [2.300]	53.34 [2.100]	48.26 [1.900]	20	3-583717-1
④	OBSOLETE	41.15					
	14 & R	38.61					
	OBSOLETE	74.17					
	7 & H	20.83 [.820]					
	6 & F	18.29 [.720]					
	50 & AF	130.05					
	OBSOLETE	104.65					
	30 & j	79.25					
	25 & c	66.55					
		[2.320]	[2.500]	[2.300]	[2.100]		
	18 & V	48.77 [1.920]	53.34 [2.100]	48.26 [1.900]	43.18 [1.700]	18	583717-7
	17 & U	46.23 [1.820]	50.80 [2.000]	45.72 [1.800]	40.64 [1.600]	17	583717-5
	15 & S	41.15 [1.620]	45.72 [1.800]	40.64 [1.600]	35.56 [1.400]	15	583717-3
	10 & L	28.45 [1.120]	33.02 [1.300]	27.94 [1.100]	22.86 [.900]	10	583717-1
	END CAVITY IDENT	D	C	B	A	POSN	PART NUMBER

THIS DRAWING IS A CONTROLLED DOCUMENT FOR AMP INCORPORATED. IT IS SUBJECT TO CHANGE AND THE CONTROLLING ENGINEERING ORGANIZATION SHOULD BE CONTACTED FOR THE LATEST REVISION.

THIS DRAWING IS A CONTROLLED DOCUMENT.		OWN: J. GALLUCCI 12-10-92 CHK: H. ROSE 2/18/94		PART NO	
DIMENSIONS: MM(INCHES)		TOLERANCES UNLESS OTHERWISE SPECIFIED:		STE TE Connectivity	
0 PLC ± .05		1 PLC ± .03		NAME: HOUSING, CRIMP SNAP	
2 PLC ± .02		3 PLC ± .01		PRODUCT SPEC: TWIN LEAF, .100 CL	
4 PLC ± .01		ANGLES ± .01		WITHOUT MOUNTING EARS	
MATERIAL: -		FINISH: -		SIZE: A1	
				CAGE CODE: 00779	
				DRAWING NO: 583717	
				SCALE: 4:1	
				SHEET 2 OF 2	
				REV: AA2	



Компания «ЭлектроПласт» предлагает заключение долгосрочных отношений при поставках импортных электронных компонентов на взаимовыгодных условиях!

Наши преимущества:

- Оперативные поставки широкого спектра электронных компонентов отечественного и импортного производства напрямую от производителей и с крупнейших мировых складов;
- Поставка более 17-ти миллионов наименований электронных компонентов;
- Поставка сложных, дефицитных, либо снятых с производства позиций;
- Оперативные сроки поставки под заказ (от 5 рабочих дней);
- Экспресс доставка в любую точку России;
- Техническая поддержка проекта, помощь в подборе аналогов, поставка прототипов;
- Система менеджмента качества сертифицирована по Международному стандарту ISO 9001;
- Лицензия ФСБ на осуществление работ с использованием сведений, составляющих государственную тайну;
- Поставка специализированных компонентов (Xilinx, Altera, Analog Devices, Intersil, Interpoint, Microsemi, Aeroflex, Peregrine, Syfer, Eurofarad, Texas Instrument, Miteq, Cobham, E2V, MA-COM, Hittite, Mini-Circuits, General Dynamics и др.);

Помимо этого, одним из направлений компании «ЭлектроПласт» является направление «Источники питания». Мы предлагаем Вам помощь Конструкторского отдела:

- Подбор оптимального решения, техническое обоснование при выборе компонента;
- Подбор аналогов;
- Консультации по применению компонента;
- Поставка образцов и прототипов;
- Техническая поддержка проекта;
- Защита от снятия компонента с производства.



Как с нами связаться

Телефон: 8 (812) 309 58 32 (многоканальный)

Факс: 8 (812) 320-02-42

Электронная почта: org@eplast1.ru

Адрес: 198099, г. Санкт-Петербург, ул. Калинина, дом 2, корпус 4, литера А.