

Cree® XLamp® XHP50.2 LEDs



PRODUCT DESCRIPTION

The XLamp XHP50.2 LED is the next generation of Extreme High Power LEDs that delivers the lowest system cost through the best lumen density, reliability and color consistency. Built on Cree's latest high-power LED technology, the XHP50.2 LED improves the lumen density, voltage characteristics, reliability and optical performance of the XHP50 LED in the same 5.0 mm x 5.0 mm footprint. The new XHP50.2 LED provides an easy drop-in upgrade to achieve higher system LPW for lighting manufacturers with existing XHP50 designs, eliminating redesign costs. Its unparalleled lumen density and longer lifetime at higher operating temperatures also enables new and innovative lighting designs at lower system costs.

FEATURES

- Available in white, configurable to 3 V, 6 V or 12 V by PCB layout
- Available in 5-step EasyWhite® bins at 3000 K to 5000 K CCT, 3-step EasyWhite bins at 2700 K to 5000 K and 2-step EasyWhite bins at 2700 K to 4000 K CCT
- Available in ANSI white bins at 3000 K to 7000 K CCT
- Available in standard, 70-, 80-, and 90-minimum CRI options
- Broadcast color option at 5700 K provides maximum performance for TV events that require extremely high TLCI
- Binned at 85 °C
- Maximum drive current: 6000 mA (3 V), 3000 mA (6 V), 1500 mA (12 V)
- Low thermal resistance: 1.2 °C/W
- Wide viewing angle: 120°
- Unlimited floor life at ≤ 30 °C/85% RH
- Reflow solderable - JEDEC J-STD-020C
- RoHS and REACH compliant
- UL® recognized component (E349212)

TABLE OF CONTENTS

Characteristics	2
Flux Characteristics, EasyWhite® Order Codes and Bins	3
Flux Characteristics, ANSI White Order Codes and Bins	5
Flux Characteristics - Broadcast Order Codes and Bins	8
Relative Spectral Power Distribution	9
Relative Flux vs. Junction Temperature.....	9
Electrical Characteristics.....	10
Relative Flux vs. Current.....	11
Relative Chromaticity vs Current.....	13
Relative Chromaticity vs Temperature.....	14
Typical Spatial Distribution.....	15
Thermal Design.....	15
Performance Groups – Luminous Flux.....	17
Performance Groups – Chromaticity.....	17
Cree's EasyWhite® Chromaticity Regions Plotted on the 1931 CIE Curve	20
Cree's ANSI Cool White Kits Plotted on ANSI Standard Chromaticity Regions.....	21
Cree's ANSI Warm and Neutral White Kits Plotted on ANSI Standard Chromaticity Regions.....	22
Bin and Order Code Formats.....	23
Reflow Soldering Characteristics.....	24
Notes	25
Mechanical Dimensions	27
Electrical Configuration	28
Tape and Reel.....	29
Packaging.....	30



CHARACTERISTICS

XHP50.2 LEDs are tested and binned in production in the 12-V configuration. See the Mechanical Dimensions section on page 27 for pad layout options.

Characteristics	Unit	Minimum	Typical	Maximum
Thermal resistance, junction to solder point	°C/W		1.2	
Viewing angle (FWHM)	degrees		120	
Temperature coefficient of voltage (3 V)*	mV/°C		-1.5	
Temperature coefficient of voltage (6 V)*	mV/°C		-3	
Temperature coefficient of voltage (12 V)	mV/°C		-6	
ESD withstand voltage (HBM per Mil-Std-883D)	V			8000
DC forward current (3 V)*	mA			6000
DC forward current (6 V)*	mA			3000
DC forward current (12 V)	mA			1500
Reverse voltage	V			5
Forward voltage (3 V, @ 2800 mA, 85 °C)*	V		2.8	3.1
Forward voltage (6 V, @ 1400 mA, 85 °C)*	V		5.6	6.2
Forward voltage (12 V, @ 700 mA, 85 °C)	V		11.2	12.4
LED junction temperature	°C			150

Note:

* Data for the 3-V and 6-V configurations are calculated and for reference only.

FLUX CHARACTERISTICS, EASYWHITE® ORDER CODES AND BINS

The following table provides order codes for XLamp XHP50.2 LEDs. For a complete description of how the flux and chromaticity groups are reflected in the bin code and order code nomenclature, please see the Bin and Order Code Formats section (page 23).

Binning condition: $T_j = 85\text{ }^\circ\text{C}$; 12 V, $I_f = 700\text{ mA}$

Reference condition: $T_j = 85\text{ }^\circ\text{C}$; 6 V, $I_f = 1400\text{ mA}$

Nominal CCT	CRI		Minimum Luminous Flux			2-Step		3-Step		5-Step	
	Min	Typ	Group	Flux (lm) @ 85 °C	Flux (lm) @ 25 °C*	Group	Order Code	Group	Order Code	Group	Order Code
5000 K	70		K2	1200	1328					50E	XHP50B-00-0000-0D0BK250E
			J4	1120	1239						XHP50B-00-0000-0D0BJ450E
	80		J4	1120	1239	40H	XHP50B-00-0000-0D0HJ440H	40G	XHP50B-00-0000-0D0HJ450G		
			J2	1040	1151				XHP50B-00-0000-0D0HJ250G		
	90		H4	970	1073	40H	XHP50B-00-0000-0D0UH440H	40G	XHP50B-00-0000-0D0UH450G		
			H2	900	996				XHP50B-00-0000-0D0UH250G		
4500 K	70		K2	1200	1328					45E	XHP50B-00-0000-0D0BK245E
			J4	1120	1239						XHP50B-00-0000-0D0BJ445E
	80		J4	1120	1239	40H	XHP50B-00-0000-0D0HJ240H	45G	XHP50B-00-0000-0D0HJ445G		
			J2	1040	1151				XHP50B-00-0000-0D0HJ245G		
	90		H4	970	1073	40H	XHP50B-00-0000-0D0UH440H	45G	XHP50B-00-0000-0D0UH445G		
			H2	900	996				XHP50B-00-0000-0D0UH245G		
4000 K	70		K2	1200	1328					40E	XHP50B-00-0000-0D0BK240E
			J4	1120	1239						XHP50B-00-0000-0D0BJ440E
	80		J4	1120	1239	40H	XHP50B-00-0000-0D0HJ240H	40G	XHP50B-00-0000-0D0HJ440G		
			J2	1040	1151				XHP50B-00-0000-0D0HJ240G		
	90		H4	970	1073	40H	XHP50B-00-0000-0D0UH440H	40G	XHP50B-00-0000-0D0UH440G		
			H2	900	996				XHP50B-00-0000-0D0UH240G		

Notes

- Cree maintains a tolerance of $\pm 7\%$ on flux and power measurements, ± 0.005 on chromaticity (CCx, CCy) measurements and a tolerance of ± 2 on CRI measurements. See the Measurements section (page 25).
- Cree XLamp XHP50.2 LED order codes specify only a minimum flux bin and not a maximum. Cree may ship reels in flux bins higher than the minimum specified by the order code without advance notice. Shipments will always adhere to the chromaticity bin restrictions specified by the order code.
- * Flux values @ 25 °C are calculated and for reference only.

FLUX CHARACTERISTICS, EASYWHITE® ORDER CODES AND BINS - CONTINUED

Nominal CCT	CRI		Minimum Luminous Flux			2-Step		3-Step		5-Step	
	Min	Typ	Group	Flux (lm) @ 85 °C	Flux (lm) @ 25 °C*	Group	Order Code	Group	Order Code	Group	Order Code
3500 K	70		K2	1200	1328					35E	XHP50B-00-0000-0D0BK235E
			J4	1120	1239						XHP50B-00-0000-0D0BJ435E
	80		J2	1040	1151	35H	XHP50B-00-0000-0D0HJ235H	35G	XHP50B-00-0000-0D0HJ235G		
			H4	970	1073		XHP50B-00-0000-0D0HH435H		XHP50B-00-0000-0D0HH435G		
	90		H4	970	1073	35H	XHP50B-00-0000-0D0UH435H	35G	XHP50B-00-0000-0D0UH435G		
			H2	900	996		XHP50B-00-0000-0D0UH235H		XHP50B-00-0000-0D0UH235G		
3000 K	70		J4	1120	1239					30E	XHP50B-00-0000-0D0BJ430E
			J2	1040	1151						XHP50B-00-0000-0D0BJ230E
	80		J2	1040	1151	30H	XHP50B-00-0000-0D0HJ230H	30G	XHP50B-00-0000-0D0HJ230G		
			H4	970	1073		XHP50B-00-0000-0D0HH430H		XHP50B-00-0000-0D0HH430G		
	90		H2	900	996	30H	XHP50B-00-0000-0D0UH230H	30G	XHP50B-00-0000-0D0UH230G		
			G4	840	930		XHP50B-00-0000-0D0UG430H		XHP50B-00-0000-0D0UG430G		
2700 K	80		H4	970	1073	27H	XHP50B-00-0000-0D0HH427H	27G	XHP50B-00-0000-0D0HH427G		
			H2	900	996		XHP50B-00-0000-0D0HH227H		XHP50B-00-0000-0D0HH227G		
	90		G4	840	930	27H	XHP50B-00-0000-0D0UG427H	27G	XHP50B-00-0000-0D0UG427G		
			G2	780	863		XHP50B-00-0000-0D0UG227H		XHP50B-00-0000-0D0UG227G		

- Notes**
- Cree maintains a tolerance of ±7% on flux and power measurements, ±0.005 on chromaticity (CCx, CCy) measurements and a tolerance of ±2 on CRI measurements. See the Measurements section (page 25).
 - Cree XLamp XHP50.2 LED order codes specify only a minimum flux bin and not a maximum. Cree may ship reels in flux bins higher than the minimum specified by the order code without advance notice. Shipments will always adhere to the chromaticity bin restrictions specified by the order code.
 - * Flux values @ 25 °C are calculated and for reference only.

FLUX CHARACTERISTICS, ANSI WHITE ORDER CODES AND BINS

The following table provides order codes for XLamp XHP50.2 LEDs. For a complete description of how the flux and chromaticity groups are reflected in the bin code and order code nomenclature, please see the Bin and Order Code Formats section (page 23).

Binning condition: $T_j = 85\text{ }^\circ\text{C}$; 12 V, $I_f = 700\text{ mA}$

Reference condition: $T_j = 85\text{ }^\circ\text{C}$; 6 V, $I_f = 1400\text{ mA}$

Reference condition: $T_j = 85\text{ }^\circ\text{C}$; 3 V, $I_f = 2800\text{ mA}$

3-V XHP50.2 LEDs

Nominal CCT	Chromaticity Regions	CRI		Minimum Luminous Flux			Order Code
		Min	Typ	Group	Flux (lm) @ 85 °C	Flux (lm) @ 25 °C*	
7000 K	0A, 0B, 0C, 0D, 0R, 0S, 0T, 0U, 1A, 1B, 1C, 1D, 1R, 1S, 1T, 1U	0	68	K2	1200	1328	XHP50B-00-0000-0A00K20DT
6200 K	0A, 0B, 0C, 0D, 0R, 0S, 0T, 0U, 1A, 1B, 1C, 1D, 1R, 1S, 1T, 1U, 2A, 2B, 2C, 2D, 2R, 2S, 2T, 2U, 3A, 3B, 3R, 3S	0	68	K2	1200	1328	XHP50B-00-0000-0A00K2051

6-V & 12-V XHP50.2 LEDs

Nominal CCT	Chromaticity Regions	CRI		Minimum Luminous Flux			Order Code
		Min	Typ	Group	Flux (lm) @ 85 °C	Flux (lm) @ 25 °C*	
7000 K	0A, 0B, 0C, 0D, 0R, 0S, 0T, 0U, 1A, 1B, 1C, 1D, 1R, 1S, 1T, 1U	0	68	K2	1200	1328	XHP50B-00-0000-0D00K20DT
				J4	1120	1239	XHP50B-00-0000-0D00J40DT
		70		K2	1200	1328	XHP50B-00-0000-0D0BK20DT
				J4	1120	1239	XHP50B-00-0000-0D0BJ40DT
		80		J4	1120	1239	XHP50B-00-0000-0D0HJ40DT
				J2	1040	1151	XHP50B-00-0000-0D0HJ20DT
6500 K	0A, 0B, 0C, 0D, 0R, 0S, 0T, 0U, 1A, 1B, 1C, 1D, 1R, 1S, 1T, 1U, 2A, 2B, 2C, 2D, 2R, 2S, 2T, 2U	0	68	K2	1200	1328	XHP50B-00-0000-0D00K20CB
				J4	1120	1239	XHP50B-00-0000-0D00J40CB
		70		K2	1200	1328	XHP50B-00-0000-0D0BK20CB
				J4	1120	1239	XHP50B-00-0000-0D0BJ40CB
		80		J4	1120	1239	XHP50B-00-0000-0D0HJ40CB
				J2	1040	1151	XHP50B-00-0000-0D0HJ20CB

Notes

- Cree maintains a tolerance of $\pm 7\%$ on flux and power measurements, ± 0.005 on chromaticity (CCx, CCy) measurements and a tolerance of ± 2 on CRI measurements. See the Measurements section (page 25).
- Cree XLamp XHP50.2 LED order codes specify only a minimum flux bin and not a maximum. Cree may ship reels in flux bins higher than the minimum specified by the order code without advance notice. Shipments will always adhere to the chromaticity bin restrictions specified by the order code.
- * Flux values @ 25 °C are calculated and for reference only.

FLUX CHARACTERISTICS, ANSI WHITE ORDER CODES AND BINS - CONTINUED

Nominal CCT	Chromaticity Regions	CRI		Minimum Luminous Flux			Order Code
		Min	Typ	Group	Flux (lm) @ 85 °C	Flux (lm) @ 25 °C*	
6500 K	1A, 1B, 1C, 1D	0	68	K2	1200	1328	XHP50B-00-0000-0D00K20E1
				J4	1120	1239	XHP50B-00-0000-0D00J40E1
		70		K2	1200	1328	XHP50B-00-0000-0D0BK20E1
				J4	1120	1239	XHP50B-00-0000-0D0BJ40E1
		80		J4	1120	1239	XHP50B-00-0000-0D0HJ40E1
				J2	1040	1151	XHP50B-00-0000-0D0HJ20E1
6000 K	1A, 1B, 1C, 1D, 1R, 1S, 1T, 1U, 2A, 2B, 2C, 2D, 2R, 2S, 2T, 2U	0	68	K2	1200	1328	XHP50B-00-0000-0D00K20DV
				J4	1120	1239	XHP50B-00-0000-0D00J40DV
		70		K2	1200	1328	XHP50B-00-0000-0D0BK20DV
				J4	1120	1239	XHP50B-00-0000-0D0BJ40DV
		80		J4	1120	1239	XHP50B-00-0000-0D0HJ40DV
				J2	1040	1151	XHP50B-00-0000-0D0HJ20DV
		90		J2	1040	1151	XHP50B-00-0000-0D0UJ20DV
				H4	970	1073	XHP50B-00-0000-0D0UH40DV
5700 K	2A, 2B, 2C, 2D	0	68	K2	1200	1328	XHP50B-00-0000-0D00K20E2
				J4	1120	1239	XHP50B-00-0000-0D00J40E2
		70		K2	1200	1328	XHP50B-00-0000-0D0BK20E2
				J4	1120	1239	XHP50B-00-0000-0D0BJ40E2
		80		J4	1120	1239	XHP50B-00-0000-0D0HJ40E2
				J2	1040	1151	XHP50B-00-0000-0D0HJ20E2
		90		J2	1040	1151	XHP50B-00-0000-0D0UJ20E2
				H4	970	1073	XHP50B-00-0000-0D0UH40E2
5000 K	3A, 3B, 3C, 3D	0	68	K2	1200	1328	XHP50B-00-0000-0D00K20E3
				J4	1120	1239	XHP50B-00-0000-0D00J40E3
		70		K2	1200	1328	XHP50B-00-0000-0D0BK20E3
				J4	1120	1239	XHP50B-00-0000-0D0BJ40E3
		80		J4	1120	1239	XHP50B-00-0000-0D0HJ40E3
				J2	1040	1151	XHP50B-00-0000-0D0HJ20E3
		90		J2	1040	1151	XHP50B-00-0000-0D0UJ20E3
				H4	970	1073	XHP50B-00-0000-0D0UH40E3

Notes

- Cree maintains a tolerance of $\pm 7\%$ on flux and power measurements, ± 0.005 on chromaticity (CCx, CCy) measurements and a tolerance of ± 2 on CRI measurements. See the Measurements section (page 25).
- Cree XLamp XHP50.2 LED order codes specify only a minimum flux bin and not a maximum. Cree may ship reels in flux bins higher than the minimum specified by the order code without advance notice. Shipments will always adhere to the chromaticity bin restrictions specified by the order code.
- * Flux values @ 25 °C are calculated and for reference only.

FLUX CHARACTERISTICS, ANSI WHITE ORDER CODES AND BINS - CONTINUED

Nominal CCT	Chromaticity Regions	CRI		Minimum Luminous Flux			Order Code		
		Min	Typ	Group	Flux (lm) @ 85 °C	Flux (lm) @ 25 °C*			
4500 K	4A, 4B, 4C, 4D	0	68	K2	1200	1328	XHP50B-00-0000-0D00K20E4		
				J4	1120	1239	XHP50B-00-0000-0D00J40E4		
		70		K2	1200	1328	XHP50B-00-0000-0D0BK20E4		
				J4	1120	1239	XHP50B-00-0000-0D0BJ40E4		
		80		J4	1120	1239	XHP50B-00-0000-0D0HJ40E4		
				J2	1040	1151	XHP50B-00-0000-0D0HJ20E4		
		90		H4	970	1073	XHP50B-00-0000-0D0UH40E4		
				H2	900	996	XHP50B-00-0000-0D0UH20E4		
		4000 K	5A, 5B, 5C, 5D	0	68	K2	1200	1328	XHP50B-00-0000-0D00K20E5
						J4	1120	1239	XHP50B-00-0000-0D00J40E5
70				K2	1200	1328	XHP50B-00-0000-0D0BK20E5		
				J4	1120	1239	XHP50B-00-0000-0D0BJ40E5		
80				J4	1120	1239	XHP50B-00-0000-0D0HJ40E5		
				J2	1040	1151	XHP50B-00-0000-0D0HJ20E5		
90				H4	970	1073	XHP50B-00-0000-0D0UH40E5		
				H2	900	996	XHP50B-00-0000-0D0UH20E5		
3500 K	6A, 6B, 6C, 6D			70		K2	1200	1328	XHP50B-00-0000-0D0BK20E6
						J4	1120	1239	XHP50B-00-0000-0D0BJ40E6
3000 K	7A, 7B, 7C, 7D	70		J4	1120	1239	XHP50B-00-0000-0D0BJ40E7		
				J2	1040	1151	XHP50B-00-0000-0D0BJ20E7		

- Notes**
- Cree maintains a tolerance of ±7% on flux and power measurements, ±0.005 on chromaticity (CCx, CCy) measurements and a tolerance of ±2 on CRI measurements. See the Measurements section (page 25).
 - Cree XLamp XHP50.2 LED order codes specify only a minimum flux bin and not a maximum. Cree may ship reels in flux bins higher than the minimum specified by the order code without advance notice. Shipments will always adhere to the chromaticity bin restrictions specified by the order code.
 - * Flux values @ 25 °C are calculated and for reference only.

FLUX CHARACTERISTICS - BROADCAST ORDER CODES AND BINS

The following table provides order codes for XLamp XHP50.2 Broadcast LEDs. For a complete description of the order code nomenclature, please see the Bin and Order Code Formats section (page 23).

Binning condition: $T_j = 85\text{ }^\circ\text{C}$; 12 V, $I_f = 700\text{ mA}$

Reference condition: $T_j = 85\text{ }^\circ\text{C}$; 6 V, $I_f = 1400\text{ mA}$

Chromaticity		Minimum Luminous Flux (lm) @ 1050 mA			Order Codes	
Kit	CCT	Flux Bin	Flux (lm) @ 85 °C	Flux (lm) @ 25 °C*	90 CRI Minimum 90 TLCI Minimum	95 CRI Minimum 95 TLCI Minimum
E2	5700 K	H2	900	996	XHP50B-00-B001-AD0UH20E2	
		G4	840	930		

Notes

- TLCI refers to the [European Broadcast Union's Television Lighting Consistency Index 2012](#), which aids broadcasters in assessing the colorimetric quality of lighting in their production environment. Cree maintains a tolerance of ± 2 on TLCI measurements. See the Measurements section (page 25).
- Cree maintains a tolerance of $\pm 7\%$ on flux and power measurements, ± 0.005 on chromaticity (CCx, CCy) measurements and a tolerance of ± 2 on CRI. See the Measurements section (page 25).
- Cree XLamp XHP502 LED order codes specify only a minimum flux bin and not a maximum. Cree may ship reels in flux bins higher than the minimum specified by the order code without advance notice. Shipments will always adhere to the chromaticity bin restrictions specified by the order code.
- * Flux values @ 25 °C are calculated and for reference only.

RELATIVE SPECTRAL POWER DISTRIBUTION



RELATIVE FLUX VS. JUNCTION TEMPERATURE

Reference condition: 3-V, $I_F = 2800$ mA; 6 V, $I_F = 1400$ mA; 12 V, $I_F = 700$ mA



ELECTRICAL CHARACTERISTICS ($T_j = 85^\circ\text{C}$)



ELECTRICAL CHARACTERISTICS ($T_j = 85\text{ }^\circ\text{C}$) - CONTINUED



RELATIVE FLUX VS. CURRENT ($T_j = 85\text{ }^\circ\text{C}$)



RELATIVE FLUX VS. CURRENT ($T_j = 85\text{ }^\circ\text{C}$) - CONTINUED



RELATIVE CHROMATICITY VS CURRENT (WARM WHITE)

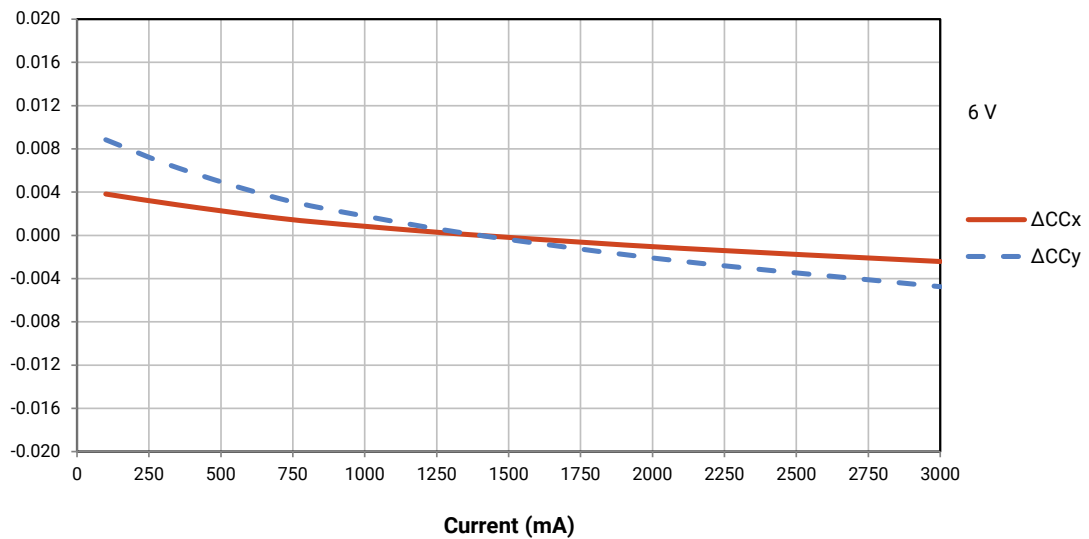
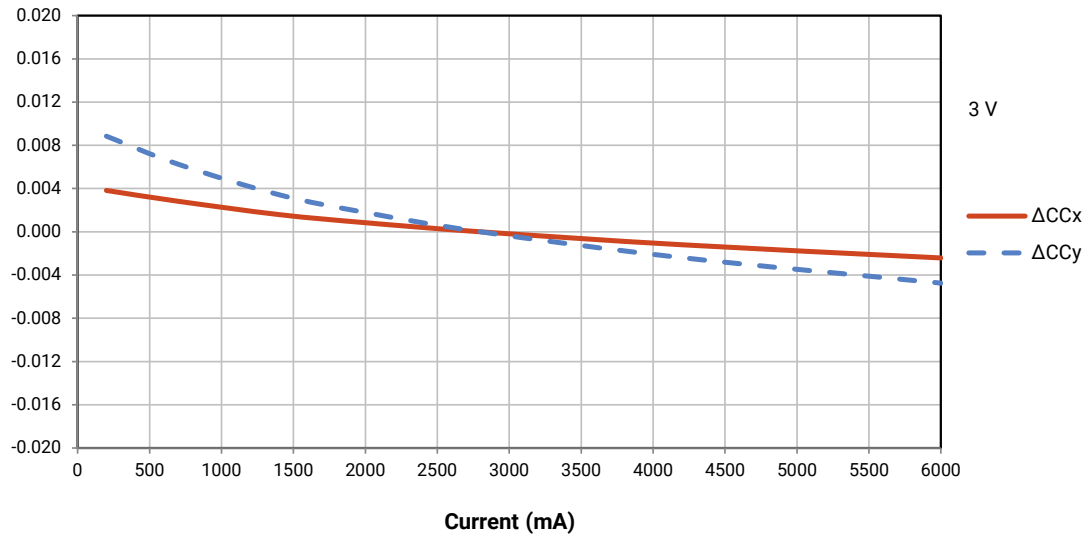

RELATIVE CHROMATICITY VS CURRENT (WARM WHITE) - CONTINUED



RELATIVE CHROMATICITY VS TEMPERATURE (WARM WHITE)

Reference condition: 3 V, $I_F = 2800$ mA; 6 V, $I_F = 1400$ mA; 12 V, $I_F = 700$ mA



TYPICAL SPATIAL DISTRIBUTION

Reference condition: $T_j = 85^\circ\text{C}$; 3 V, $I_f = 2800\text{ mA}$; 6 V, $I_f = 1400\text{ mA}$; 12 V, $I_f = 700\text{ mA}$



THERMAL DESIGN

The maximum forward current is determined by the thermal resistance between the LED junction and ambient. It is crucial for the end product to be designed in a manner that minimizes the thermal resistance from the solder point to ambient in order to optimize lamp life and optical characteristics.



THERMAL DESIGN - CONTINUED



PERFORMANCE GROUPS – LUMINOUS FLUX ($T_j = 85\text{ }^\circ\text{C}$)

XLamp XHP50.2 LEDs are tested for luminous flux and placed into one of the following luminous-flux groups.

Group Code	Minimum Luminous Flux	Maximum Luminous Flux
G2	780	840
G4	840	900
H2	900	970
H4	970	1040
J2	1040	1120
J4	1120	1200
K2	1200	1290
K4	1290	1380

PERFORMANCE GROUPS – CHROMATICITY

XLamp XHP50.2 LEDs are tested for chromaticity and placed into one of the regions defined by the following bounding coordinates.

EasyWhite Color Temperatures – 2-Step			
Bin Code	CCT	x	y
40H	4000 K	0.3777	0.3739
		0.3797	0.3816
		0.3861	0.3855
		0.3838	0.3777
35H	3500 K	0.4022	0.3858
		0.4053	0.3942
		0.4125	0.3977
		0.4091	0.3891
30H	3000 K	0.4287	0.3975
		0.4328	0.4064
		0.4390	0.4086
		0.4347	0.3996
27H	2700 K	0.4524	0.4048
		0.4574	0.4140
		0.4633	0.4154
		0.4581	0.4062

PERFORMANCE GROUPS – CHROMATICITY (CONTINUED)

EasyWhite Color Temperatures – 3-Step Ellipse						
Bin Code	CCT	Center Point		Major Axis	Minor Axis	Rotation Angle (°)
		x	y	a	b	
50G	5000 K	0.3447	0.3553	0.00840	0.00312	65.0
45G	4500 K	0.3611	0.3658	0.00852	0.00330	61.5
40G	4000 K	0.3818	0.3797	0.00939	0.00402	53.7
35G	3500 K	0.4073	0.3917	0.00927	0.00414	54.0
30G	3000 K	0.4338	0.4030	0.00834	0.00408	53.2
27G	2700 K	0.4577	0.4099	0.00834	0.00420	48.5

EasyWhite Color Temperatures – 5-Step Ellipse						
Bin Code	CCT	Center Point		Major Axis	Minor Axis	Rotation Angle (°)
		x	y	a	b	
50E	5000 K	0.3447	0.3553	0.01400	0.00520	65.0
45E	4500 K	0.3611	0.3658	0.01420	0.00550	61.5
40E	4000 K	0.3818	0.3797	0.01565	0.00670	53.7
35E	3500 K	0.4073	0.3917	0.01545	0.00690	54.0
30E	3000 K	0.4338	0.4030	0.01390	0.00680	53.2

ANSI White Bins			
CCT	Bin Code	x	y
7000 K	0A0	0.2950	0.2970
		0.2920	0.3060
		0.2984	0.3133
		0.3009	0.3042
	0B0	0.2920	0.3060
		0.2895	0.3135
		0.2962	0.3220
		0.2984	0.3133
	0C0	0.2984	0.3133
		0.2962	0.3220
		0.3028	0.3304
		0.3048	0.3207
	0D0	0.2984	0.3133
		0.3048	0.3207
		0.3068	0.3113
		0.3009	0.3042

ANSI White Bins			
CCT	Bin Code	x	y
7000 K	0R0	0.2980	0.2880
		0.2950	0.2970
		0.3009	0.3042
		0.3037	0.2937
	0S0	0.2895	0.3135
		0.2870	0.3210
		0.2937	0.3312
		0.2962	0.3220
	0T0	0.2962	0.3220
		0.2937	0.3312
		0.3005	0.3415
		0.3028	0.3304
	0U0	0.3037	0.2937
		0.3009	0.3042
		0.3068	0.3113
		0.3093	0.2993

ANSI White Bins			
CCT	Bin Code	x	y
7000 K	1A0	0.3048	0.3207
		0.3130	0.3290
		0.3144	0.3186
		0.3068	0.3113
	1B0	0.3028	0.3304
		0.3115	0.3391
		0.3130	0.3290
		0.3048	0.3207
	1C0	0.3115	0.3391
		0.3205	0.3481
		0.3213	0.3373
		0.3130	0.3290
	1D0	0.3130	0.3290
		0.3213	0.3373
		0.3221	0.3261
		0.3144	0.3186

PERFORMANCE GROUPS – CHROMATICITY (CONTINUED)

ANSI White Bins			
CCT	Bin Code	x	y
7000 K	1R0	0.3068	0.3113
		0.3144	0.3186
		0.3161	0.3059
		0.3093	0.2993
	1S0	0.3005	0.3415
		0.3099	0.3509
		0.3115	0.3391
		0.3028	0.3304
	1T0	0.3099	0.3509
		0.3196	0.3602
		0.3205	0.3481
		0.3115	0.3391
	1U0	0.3144	0.3186
		0.3221	0.3261
		0.3231	0.3120
		0.3161	0.3059

ANSI White Bins			
CCT	Bin Code	x	y
6000 K	2A0	0.3215	0.3350
		0.3290	0.3417
		0.3290	0.3300
		0.3222	0.3243
	2B0	0.3207	0.3462
		0.3290	0.3538
		0.3290	0.3417
		0.3215	0.3350
	2C0	0.3290	0.3538
		0.3376	0.3616
		0.3371	0.3490
		0.3290	0.3417
	2D0	0.3290	0.3417
		0.3371	0.3490
		0.3366	0.3369
		0.3290	0.3300

ANSI White Bins			
CCT	Bin Code	x	y
6000 K	2R0	0.3222	0.3243
		0.3290	0.3300
		0.3290	0.3180
		0.3231	0.3120
	2S0	0.3196	0.3602
		0.3290	0.3690
		0.3290	0.3538
		0.3207	0.3462
	2T0	0.3290	0.3690
		0.3381	0.3762
		0.3376	0.3616
		0.3290	0.3538
	2U0	0.3290	0.3300
		0.3366	0.3369
		0.3361	0.3245
		0.3290	0.3180

ANSI White Bins			
CCT	Bin Code	x	y
5000 K	3A0	0.3371	0.3490
		0.3451	0.3554
		0.3440	0.3427
		0.3366	0.3369
	3B0	0.3376	0.3616
		0.3463	0.3687
		0.3451	0.3554
		0.3371	0.3490
	3C0	0.3463	0.3687
		0.3551	0.3760
		0.3533	0.3620
		0.3451	0.3554
	3D0	0.3451	0.3554
		0.3533	0.3620
		0.3515	0.3487
		0.3440	0.3427

ANSI White Bins			
CCT	Bin Code	x	y
4500 K	4A0	0.3530	0.3597
		0.3615	0.3659
		0.3512	0.3465
		0.3515	0.3487
	4B0	0.3548	0.3736
		0.3641	0.3804
		0.3530	0.3597
		0.3533	0.362
	4C0	0.3641	0.3804
		0.3736	0.3874
		0.3702	0.3722
		0.3615	0.3659
	4D0	0.3615	0.3659
		0.3702	0.3722
		0.3670	0.3578
		0.3590	0.3521

PERFORMANCE GROUPS – CHROMATICITY (CONTINUED)

ANSI White Bins			
CCT	Bin Code	x	y
4000 K	5A0	0.3670	0.3578
		0.3702	0.3722
		0.3825	0.3798
		0.3783	0.3646
	5B0	0.3702	0.3722
		0.3736	0.3874
		0.3869	0.3958
		0.3825	0.3798
	5C0	0.3825	0.3798
		0.3869	0.3958
		0.4006	0.4044
		0.3950	0.3875
	5D0	0.3783	0.3646
		0.3825	0.3798
		0.3950	0.3875
		0.3898	0.3716

ANSI White Bins			
CCT	Bin Code	x	y
3500 K	6A0	0.3889	0.3690
		0.3941	0.3848
		0.4080	0.3916
		0.4017	0.3751
	6B0	0.3941	0.3848
		0.3996	0.4015
		0.4146	0.4089
		0.4080	0.3916
	6C0	0.4080	0.3916
		0.4146	0.4089
		0.4299	0.4165
		0.4221	0.3984
	6D0	0.4017	0.3751
		0.4080	0.3916
		0.4221	0.3984
		0.4147	0.3814

ANSI White Bins			
CCT	Bin Code	x	y
3000 K	7A0	0.4147	0.3814
		0.4221	0.3984
		0.4342	0.4028
		0.4259	0.3853
	7B0	0.4221	0.3984
		0.4299	0.4165
		0.4430	0.4212
		0.4342	0.4028
	7C0	0.4342	0.4028
		0.4430	0.4212
		0.4562	0.4260
		0.4465	0.4071
	7D0	0.4259	0.3853
		0.4342	0.4028
		0.4465	0.4071
		0.4373	0.3893

CREE'S EASYWHITE® CHROMATICITY REGIONS PLOTTED ON THE 1931 CIE CURVE



CREE'S ANSI COOL WHITE KITS PLOTTED ON ANSI STANDARD CHROMATICITY REGIONS

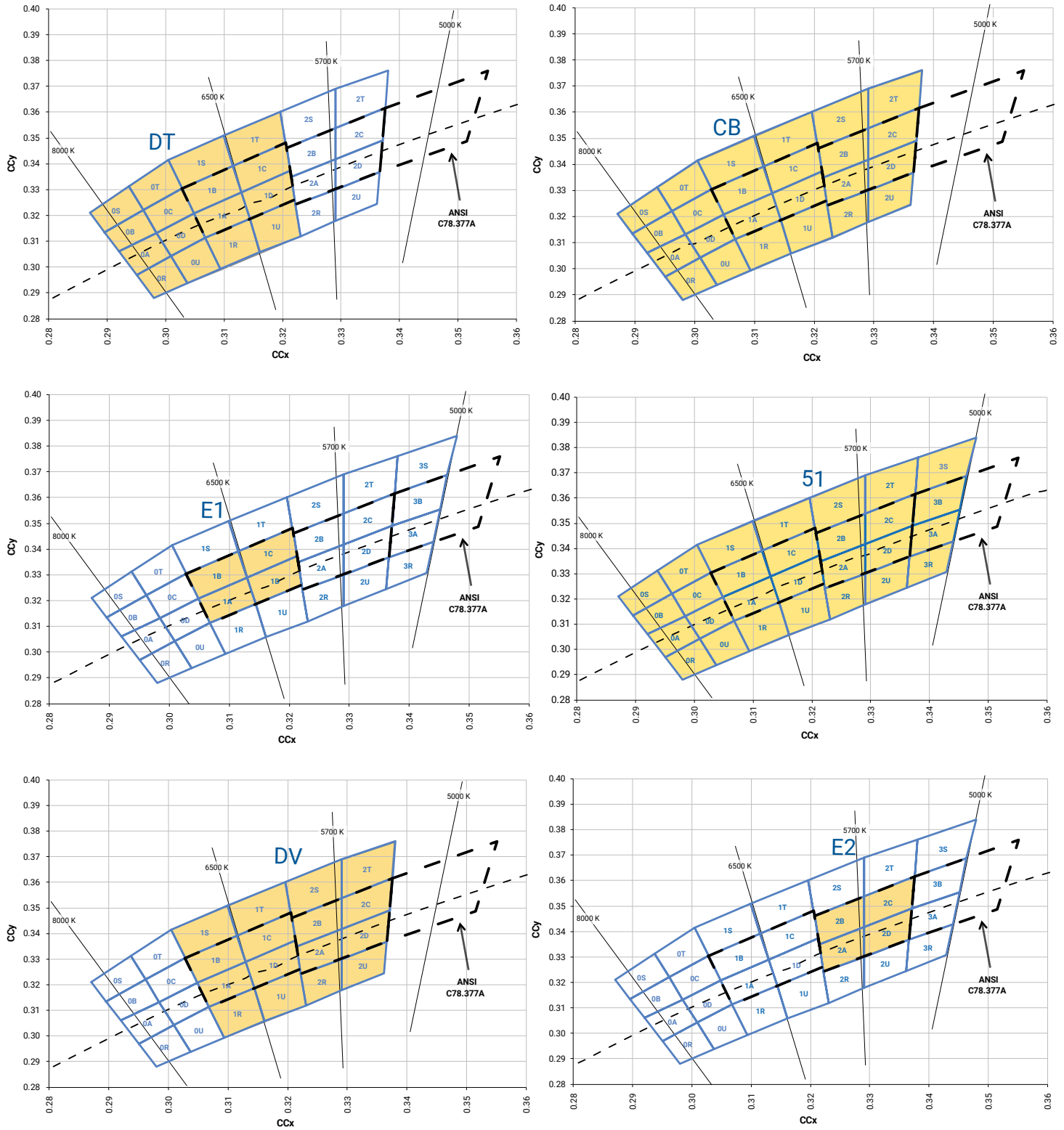

CREE'S ANSI WARM AND NEUTRAL WHITE KITS PLOTTED ON ANSI STANDARD CHROMATICITY REGIONS



BIN AND ORDER CODE FORMATS

Bin codes and order codes for XHP50.2 LEDs are configured in the following manner:



REFLOW SOLDERING CHARACTERISTICS

In testing, Cree has found XLamp XHP50.2 LEDs to be compatible with JEDEC J-STD-020C, using the parameters listed below. As a general guideline, Cree recommends that users follow the recommended soldering profile provided by the manufacturer of the solder paste used, and therefore it is the lamp or luminaire manufacturer’s responsibility to determine applicable soldering requirements.

Note that this general guideline may not apply to all PCB designs and configurations of reflow soldering equipment.



IPC/JEDEC J-STD-020C

Profile Feature	Lead-Free Solder
Average Ramp-Up Rate ($T_{s_{max}}$ to T_P)	1.2 °C/second
Preheat: Temperature Min ($T_{s_{min}}$)	120 °C
Preheat: Temperature Max ($T_{s_{max}}$)	170 °C
Preheat: Time ($t_{s_{min}}$ to $t_{s_{max}}$)	65-150 seconds
Time Maintained Above: Temperature (T_L)	217 °C
Time Maintained Above: Time (t_L)	45-90 seconds
Peak/Classification Temperature (T_P)	235 - 245 °C
Time Within 5 °C of Actual Peak Temperature (t_p)	20-40 seconds
Ramp-Down Rate	1 - 6 °C/second
Time 25 °C to Peak Temperature	4 minutes max.

Note: All temperatures refer to the topside of the package, measured on the package body surface.

NOTES

Measurements

The luminous flux, radiant power, chromaticity, forward voltage and CRI measurements in this document are binning specifications only and solely represent product measurements as of the date of shipment. These measurements will change over time based on a number of factors that are not within Cree's control and are not intended or provided as operational specifications for the products. Calculated values are provided for informational purposes only and are not intended or provided as specifications.

Pre-Release Qualification Testing

Please read the [LED Reliability Overview](#) for details of the qualification process Cree applies to ensure long-term reliability for XLamp LEDs and details of Cree's pre-release qualification testing for XLamp LEDs. Cree did not perform Room Temperature Operating Life (RTOL) testing on the XHP50.2 LED.

Lumen Maintenance

Cree now uses standardized IES LM-80-08 and TM-21-11 methods for collecting long-term data and extrapolating LED lumen maintenance. For information on the specific LM-80 data sets available for this LED, refer to the public [LM-80 results document](#).

Please read the [Long-Term Lumen Maintenance application note](#) for more details on Cree's lumen maintenance testing and forecasting. Please read the [Thermal Management application note](#) for details on how thermal design, ambient temperature, and drive current affect the LED junction temperature.

Moisture Sensitivity

Cree recommends keeping XLamp LEDs in the provided, resealable moisture-barrier packaging (MBP) until immediately prior to soldering. Unopened MBPs that contain XLamp LEDs do not need special storage for moisture sensitivity.

Once the MBP is opened, XLamp XHP50.2 LEDs may be stored as MSL 1 per JEDEC J-STD-033, meaning they have unlimited floor life in conditions of ≤ 30 °C/85% relative humidity (RH). Regardless of the storage condition, Cree recommends sealing any unsoldered LEDs in the original MBP.

RoHS Compliance

The levels of RoHS restricted materials in this product are below the maximum concentration values (also referred to as the threshold limits) permitted for such substances, or are used in an exempted application, in accordance with EU Directive 2011/65/EC (RoHS2), as implemented January 2, 2013. RoHS Declarations for this product can be obtained from your Cree representative or from the [Product Ecology](#) section of the Cree website.

REACH Compliance

REACH substances of very high concern (SVHCs) information is available for this product. Since the European Chemical Agency (ECHA) has published notice of their intent to frequently revise the SVHC listing for the foreseeable future, please contact a Cree representative to insure you get the most up-to-date REACH SVHC Declaration. REACH banned substance information (REACH Article 67) is also available upon request.

NOTES - CONTINUED

UL® Recognized Component

This product meets the requirements to be considered a UL Recognized Component with Level 4 enclosure consideration. The LED package or a portion thereof has been investigated as a fire and electrical enclosure per ANSI/UL 8750.

Vision Advisory

WARNING: Do not look at an exposed lamp in operation. Eye injury can result. For more information about LEDs and eye safety, please refer to the [LED Eye Safety application note](#).

MECHANICAL DIMENSIONS

Thermal vias, if present, are not shown on these drawings.

All dimensions are ± 0.13 mm unless otherwise indicated.



**Recommended PCB Solder Pad
3 V or 6 V Configuration
Depending on Vf Class
(thermal pad is electrically isolated)**

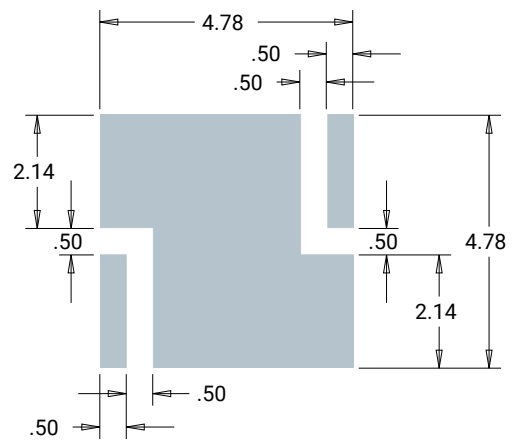

**Recommended PCB Solder Pad
12 V Configuration
(thermal pad is connected to anode and cathode
and is not electrically isolated)**

MECHANICAL DIMENSIONS - CONTINUED



**Recommended Stencil Pattern
6 V & 12 V Configurations
(shaded area is open)**

ELECTRICAL CONFIGURATION



6-V Configuration



12-V Configuration

TAPE AND REEL

All Cree carrier tapes conform to EIA-481D, Automated Component Handling Systems Standard.
 All dimensions are ±.13 mm unless otherwise indicated.

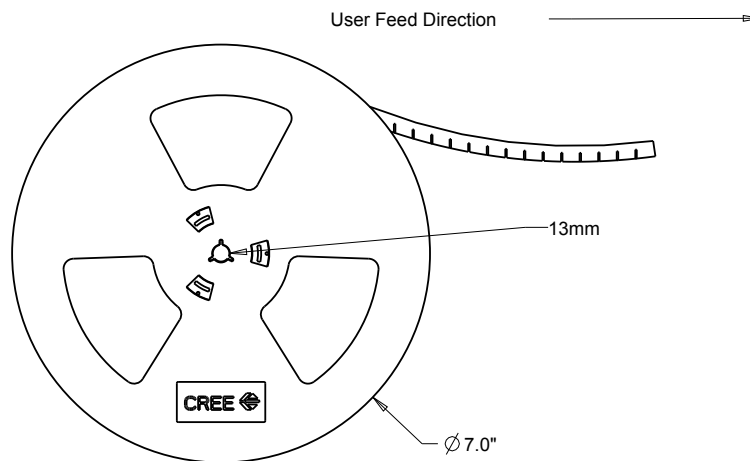
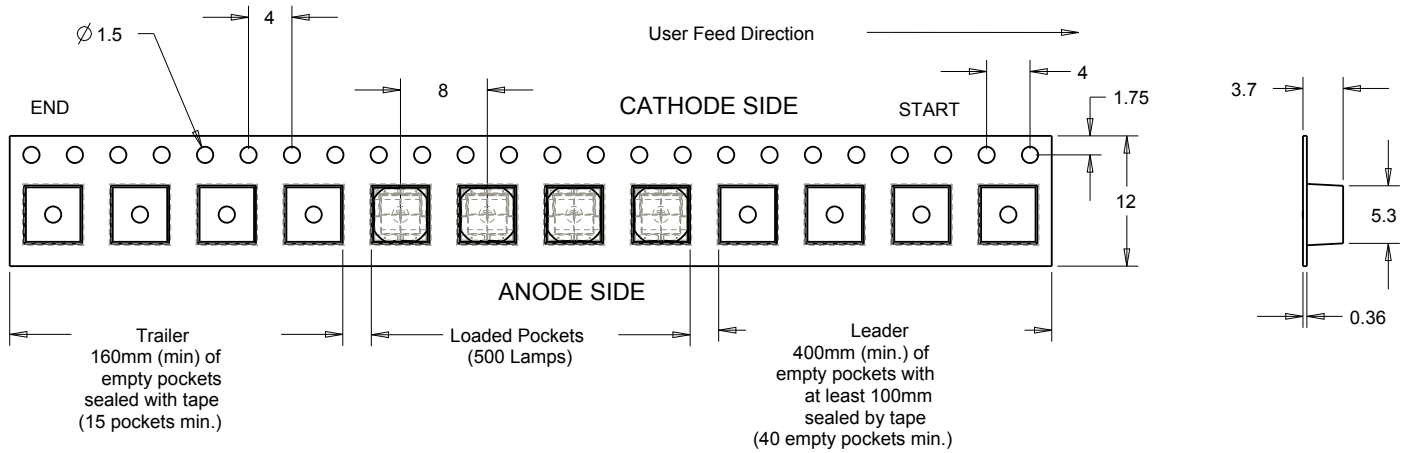

PACKAGING

Unpackaged Reel



Label with Cree Bin Code,
Quantity, Reel ID

Packaged Reel



Label with Cree Order Code,
Quantity, Reel ID, PO #

Label with Cree Bin Code,
Quantity, Reel ID

Boxed Reel

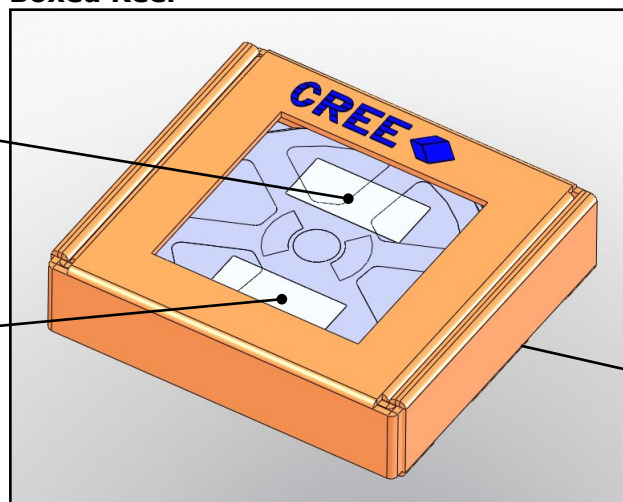

Label with Cree Order Code,
Quantity, Reel ID, PO #

Label with Cree Bin Code,
Quantity, Reel ID

Patent Label
(on bottom of box)



Компания «ЭлектроПласт» предлагает заключение долгосрочных отношений при поставках импортных электронных компонентов на взаимовыгодных условиях!

Наши преимущества:

- Оперативные поставки широкого спектра электронных компонентов отечественного и импортного производства напрямую от производителей и с крупнейших мировых складов;
- Поставка более 17-ти миллионов наименований электронных компонентов;
- Поставка сложных, дефицитных, либо снятых с производства позиций;
- Оперативные сроки поставки под заказ (от 5 рабочих дней);
- Экспресс доставка в любую точку России;
- Техническая поддержка проекта, помощь в подборе аналогов, поставка прототипов;
- Система менеджмента качества сертифицирована по Международному стандарту ISO 9001;
- Лицензия ФСБ на осуществление работ с использованием сведений, составляющих государственную тайну;
- Поставка специализированных компонентов (Xilinx, Altera, Analog Devices, Intersil, Interpoint, Microsemi, Aeroflex, Peregrine, Syfer, Eurofarad, Texas Instrument, Miteq, Cobham, E2V, MA-COM, Hittite, Mini-Circuits, General Dynamics и др.);

Помимо этого, одним из направлений компании «ЭлектроПласт» является направление «Источники питания». Мы предлагаем Вам помощь Конструкторского отдела:

- Подбор оптимального решения, техническое обоснование при выборе компонента;
- Подбор аналогов;
- Консультации по применению компонента;
- Поставка образцов и прототипов;
- Техническая поддержка проекта;
- Защита от снятия компонента с производства.



Как с нами связаться

Телефон: 8 (812) 309 58 32 (многоканальный)

Факс: 8 (812) 320-02-42

Электронная почта: org@eplast1.ru

Адрес: 198099, г. Санкт-Петербург, ул. Калинина, дом 2, корпус 4, литера А.