

# PCB Relay G5RL

## Low-profile Relay with Various Models

- Low profile: 15.7 mm in height
- Creepage distance 8mm between coil and contacts
- 10 kV Impulse withstand voltage
- Models with AC coil available.
- High-Inrush model available (Inrush peak currents up to 100 A)
- Low Noise model available (Approx. 10 to 20 dB less sound pressure than standard G5RL-Series Relays)
- RoHS Compliant

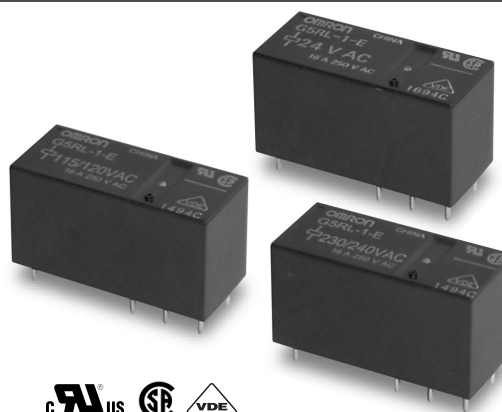

## Ordering Information

Classification		Enclosure ratings	Contact form	
Contact ratings	Special function		SPST-NO	SPDT
16 A (high capacity)	AC coil	Flux protection	—	G5RL-1-E
	High inrush		G5RL-1A-E-HR	G5RL-1-E-HR
	Low noise		G5RL-1A-E-LN	
12 A			G5RL-1A-LN	

**Note:** When ordering, add the rated coil voltage to the model number. Example: G5RL-1A-LN DC12

## Model Number Legend:

G5RL-       -       DC (AC)   

1   2   3   4   5

### 1. Number of Poles

1: 1 pole

### 2. Contact Form/Contact Construction

None: SPDT

A: SPST-NO

### 3. Classification

None: 12 A

E: 16 A (high capacity)

### 4. Special Function

None: Standard

HR: High-inrush

LN: Low Noise

### 5. Rated Coil Voltage

Coil ratings are listed in each section (AC coil, High inrush, and Low noise).

# Models with AC Coil: G5RL-1-E

## ■ Specifications

### Coil Ratings

Rated voltage	24 VAC	100 VAC	115 VAC/120 VAC		200 VAC	230 VAC/240 VAC	
Rated current at 50 Hz	31.30 mA	7.50 mA	5.85 mA	6.25 mA	3.75 mA	3.00 mA	3.13 mA
Rated current at 60 Hz	28.30 mA	6.88 mA	5.35 mA	5.70 mA	3.45 mA	2.76 mA	2.88 mA
Coil resistance	443 Ω	8,220 Ω	11,600 Ω		33,000 Ω	47,600 Ω	
Must operate voltage	75% max. rated voltage						
Must release voltage	15% min. rated voltage						
Max. voltage	110% of rated voltage						
Power consumption	Approx. 0.75 VA						

**Note:** 1. The rated current tolerance is +15%/–20%. All above data is based on coil temperature of 23°C.  
2. Coil resistances are provided as reference values.

### Contact Ratings

Contact form	SPDT
Contact material	Ag alloy (Cd free)
Rated load (resistive)	16 A at 250 VAC, 24 VDC (NO) when there is no load on (NC) 5 A at 250 VAC, 24 VDC (SPDT)
Rated carry current	16 A (NO), 5 A (NC)
Max. switching voltage	250 VAC, 24 VDC
Max. switching current	16 A (NO), 5 A (NC)
Max. switching capacity	4,000 VA, 384 W (NO) when there is no load on (NC) 1,250 VA, 120 W (SPDT)
Min. permissible load (reference value)	40 mA at 24 VDC: P level: $\lambda_{60} = 0.1 \times 10^{-6}$ operations

### Characteristics

Contact resistance	100 mΩ max.
Operate time	20 ms max.
Release time	20 ms max.
Insulation resistance	1,000 MΩ min. (at 500 VDC)
Dielectric strength	6,000 VAC, 50/60 Hz for 1 min between coil and contacts 1,000 VAC, 50/60 Hz for 1 min between contacts of same polarity
Impulse withstand voltage	10 kV between coil and contacts (1.2 × 50 μs)
Vibration resistance	Destruction: 10 to 55 Hz, 1.5-mm double amplitude Malfunction: 10 to 55 Hz, 1.5-mm double amplitude
Shock resistance	Destruction: 1,000 m/s <sup>2</sup> (approx. 100G) Malfunction: 100 m/s <sup>2</sup> (approx. 10G)
Life expectancy	Mechanical: 10,000,000 operations min. (at 18,000 operations/hr) Electrical: 100,000 operations min. (at 1,800 operations/hr) (Resistive load, 12A, 250 VAC/24 VDC, NO contact) 50,000 operations min. (at 1,800 operations/hr) (Resistive load, 16 A, 250 VAC/24 VDC, NO contact) (Resistive load, 5 A, 250 VAC/24 VDC, NC contact)
Ambient temperature	Operating: –40°C to 70°C (with no icing or condensation)
Ambient humidity	Operating: 5% to 85%
Weight	Approx. 10 g

**Note:** 1. Values in the above table are initial values.  
2. The contact resistance is measured with 1 A applied at 5 VDC using voltage drop method.  
3. The insulation resistance is measured between coil and contacts and between contacts of the same polarity at 500 VDC.  
4. The resistive load ratings for NO contact apply when there is no load on NC contact.

## Approved Standards

 UL Recognized (File No. E41643) and  CSA Certified (File No. LR31928) -- Ambient Temp. = 40°C

Model	Coil rating	Contact rating
G5RL-1-E	24 to 240 VAC	16 A, 277 VAC General, 50,000 operations - NO 16 A, 250 VAC General, 50,000 operations - NO TV-5, 25,000 operations - NO A300 Pilot Duty, 720 VA, 240 VAC, 30,000 operations - NO 1/2 Hp, 120 VAC, 6,000 operations - NO 60 LRA/10 FLA, 250 VAC, 6,000 operations - NO 5 A, 250 VAC General, 50,000 operations - NC 5 A, 24 VDC Resistive, 50,000 operations - NC

 VDE (EN61810-1) (License No. A282)

Model	Coil Rating	Contact rating
G5RL-1-E	24, 100, 115/120, 200, 230/240 VAC (50 Hz)	16 A, 250 VAC 15,000 operations - NO

## Dimensions

Note: All units are in millimeters unless otherwise indicated.

### G5RL-1-E

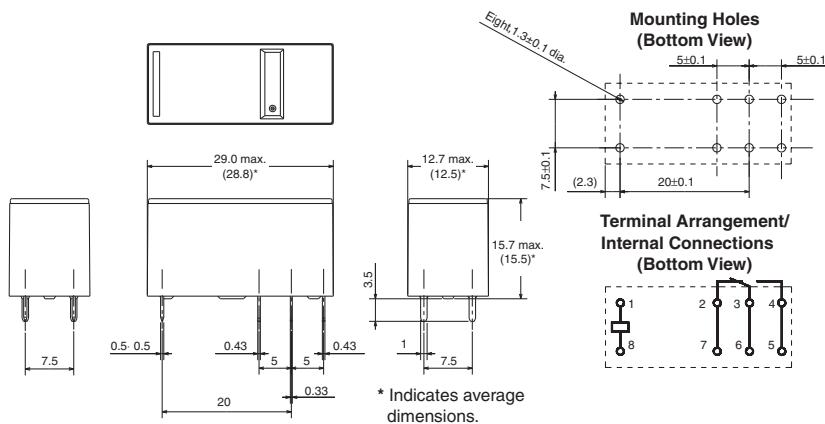
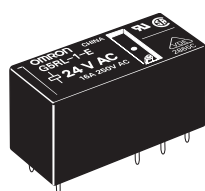

## Precautions

### Wiring

High-capacity models (-E) have a structure that connects two terminals from one contact. When designing the circuit, use both terminals. If you use only one terminal, the relay may be unable to satisfy specified performance.

# High-Inrush Models: G5RL-1(A)-E-HR

## ■ Specifications

### Coil Ratings

Rated voltage	5 VDC	12 VDC	24 VDC	48 VDC
Rated current	80.0 mA	33.3 mA	16.7 mA	8.96 mA
Coil resistance	62.5 Ω	360 Ω	1,440 Ω	5,358 Ω
Must operate voltage	70% max. rated voltage			
Must release voltage	10% min. rated voltage			
Max. voltage	130% of rated voltage			
Power consumption	Approx. 400 mW			Approx. 430 mW

Note: The rated current and resistance are measured at a coil temperature of 23°C with a tolerance of ±10%.

### Contact Ratings

Contact form	SPST-NO	SPDT
Contact material	Ag alloy (Cd free)	
Rated load (resistive)	16 A at 250 VAC 16 A at 24 VDC	16 A at 250 VAC, 24 VDC (NO) when there is no load on (NC) 5 A at 250 VAC, 24 VDC (SPDT)
Rated carry current	16 A	16 A (NO), 5 A (NC)
Max. switching voltage	250 VAC, 24 VDC	
Max. switching current	16 A	16 A (NO), 5 A (NC)
Max. switching capacity	4,000 VA, 384 W	4,000 VA, 384 W (NO) when there is no load on (NC) 1,250 VA, 120 W (SPDT)
Min. permissible load (reference value)	100 mA at 5 VDC: P level: $\lambda_{60} = 0.1 \times 10^{-6}$ operations	

### Characteristics

Contact resistance	100 mΩ max.
Operate time	15 ms max.
Release time	5 ms max.
Insulation resistance	1,000 MΩ min. (at 500 VDC)
Dielectric strength	6,000 VAC, 50/60 Hz for 1 min between coil and contacts 1,000 VAC, 50/60 Hz for 1 min between contacts of same polarity
Impulse withstand voltage	10 kV between coil and contacts (1.2 × 50 μs)
Vibration resistance	Destruction: 10 to 55 Hz, 1.5-mm double amplitude Malfunction: 10 to 55 Hz, 1.5-mm double amplitude
Shock resistance	Destruction: 1,000 m/s <sup>2</sup> (approx. 100G) Malfunction: 100 m/s <sup>2</sup> (approx. 10G)
Life expectancy	Mechanical: 10,000,000 operations min. (at 18,000 operations/hr) Electrical: 100,000 operations min. (at 1,800 operations/hr) (Resistive load, 12A, 250 VAC/24 VDC, NO contact) 50,000 operations min. (at 1,800 operations/hr) (Resistive load, 16 A, 250 VAC/24 VDC, NO contact) (Resistive load, 5 A, 250 VAC/24 VDC, NC contact)
Ambient temperature	Operating: -40°C to 85°C (with no icing or condensation)
Ambient humidity	Operating: 5% to 85%
Weight	Approx. 10 g

Note: 1. Values in the above table are initial values.

2. The contact resistance is measured with 1 A applied at 5 VDC using voltage drop method.
3. The insulation resistance is measured between coil and contacts and between contacts of the same polarity at 500 VDC.
4. The resistive load ratings for NO contact apply when there is no load on NC contact.

## Approved Standards

 UL Recognized (File No. E41643) and  CSA Certified (File No. LR31928) - - Ambient Temp. = 40°C

Model	Coil rating	Contact rating
G5RL-1(A)-E-HR	5 to 48 VAC	16 A, 277 VAC General, 50,000 operations - NO 16 A, 250 VAC General, 50,000 operations - NO TV-5, 25,000 operations - NO A300 Pilot Duty, 720 VA, 240 VAC, 30,000 operations - NO 1/2 Hp, 120 VAC, 6,000 operations - NO 60 LRA/10 FLA, 250 VAC, 6,000 operations - NO 5 A, 250 VAC General, 50,000 operations - NC 5 A, 24 VDC Resistive, 50,000 operations - NC )

 VDE (EN61810-1) (License No. A282)

Model	Coil Rating	Contact rating
G5RL-1(A)-E-HR	5, 12, 24, 48 VDC	16 A, 250 VAC $\cos \phi = 1$ 15,000 operations - NO 240 VAC 100 A (0-P) Steady 10 A (rms) 50,000 operations - NO 240 VAC 50 A (0-P) Steady 5 A (rms) 100,000 operations - NO

## Dimensions

Note: All units are in millimeters unless otherwise indicated.

### G5RL-1(A)-E-HR

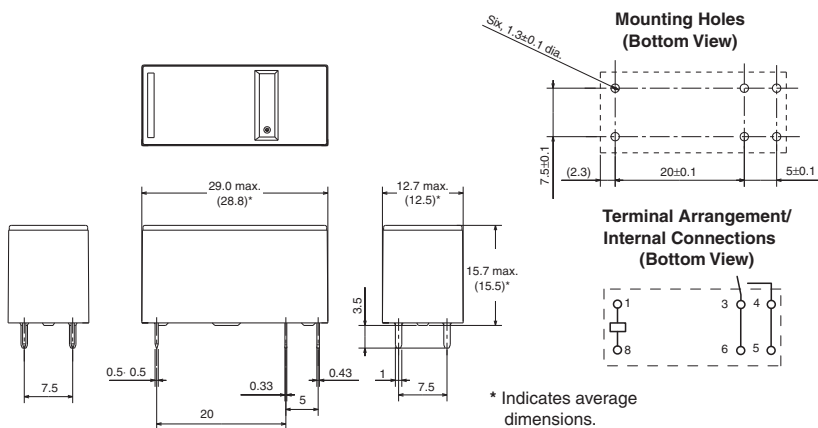
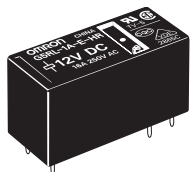

### G5RL-1-E-HR

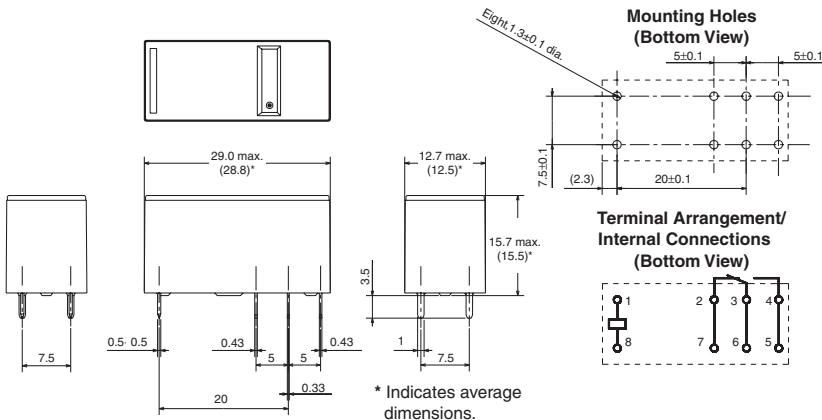
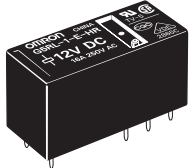

## Precautions

### Wiring

High-capacity models (-E) have a structure that connects two terminals from one contact. When designing the circuit, use both terminals. If you use only one terminal, the relay may be unable to satisfy specified performance.

# Low Noise Models: G5RL-1A(-E)-LN

## ■ Specifications

### Coil Ratings

Rated voltage	5 VDC	12 VDC	24 VDC
Rated current	106.0 mA	44.2 mA	22.1 mA
Coil resistance	47.2 Ω	272 Ω	1,086 Ω
Must operate voltage	70% max. rated voltage		
Must release voltage	10% min. rated voltage		
Max. voltage	110% of rated voltage		
Power consumption	Approx. 530 mW		

Note: The rated current and resistance are measured at a coil temperature of 23°C with a tolerance of ±10%.

### Contact Ratings

Item	Standard	High capacity
Contact form	SPST-NO	
Contact material	Ag alloy (Cd free)	
Rated load (resistive)	12 A at 250 VAC 12 A at 24 VDC	16 A at 250 VAC 16 A at 24 VDC
Rated carry current	12 A	16 A
Max. switching voltage	250 VAC, 24 VDC	
Max. switching current	12 A	16 A
Max. switching capacity	3,000 VA, 288 W	4,000 VA, 384 W
Min. permissible load (reference value)	100 mA at 5 VDC: P level: $\lambda_{60} = 0.1 \times 10^{-6}$ operations	

### Characteristics

Item	Standard	High capacity
Contact resistance	100 mΩ max.	
Operate time	15 ms max.	
Release time	15 ms max.	
Insulation resistance	1,000 MΩ min. (at 500 VDC)	
Dielectric strength	6,000 VAC, 50/60 Hz for 1 min between coil and contacts 1,000 VAC, 50/60 Hz for 1 min between contacts of same polarity	
Impulse withstand voltage	10 kV between coil and contacts (1.2 × 50 μs)	
Vibration resistance	Destruction: 10 to 55 Hz, 1.5-mm double amplitude Malfunction: 10 to 55 Hz, 1.5-mm double amplitude	
Shock resistance	Destruction: 1,000 m/s <sup>2</sup> (approx. 100G) Malfunction: 100 m/s <sup>2</sup> (approx. 10G)	
Life expectancy	Mechanical: 1,000,000 operations min. (at 18,000 operations/hr)  Electrical: 100,000 operations min. Resistive load, 12 A, 250 VAC / 24 VDC (at 1,800 operations/hr)	Mechanical: 1,000,000 operations min. (at 18,000 operations/hr)  Electrical: 50,000 operations min. Resistive load, 16 A, 250 VAC / 24 VDC (at 1,800 operations/hr)
Ambient temperature	Operating: -40°C to 85°C (with no icing or condensation)	
Ambient humidity	Operating: 5% to 85%	
Weight	Approx. 10 g	

Note: 1. Values in the above table are initial values.

2. The contact resistance is measured with 1 A applied at 5 VDC using voltage drop method.

3. The insulation resistance is measured between coil and contacts and between contacts of the same polarity at 500 VDC.

4. The release time of 15ms max. is based on adding a diode to coil circuit.

## Approved Standards

**UL / cUL Recognized (File No. E41643) - - Ambient Temp. = 40°C**

Model	Coil rating	Contact rating
G5RL-1A-LN	5 to 24 VAC	12 A, 250 VAC Resistive, 100,000 operations 12 A, 24 VDC Resistive, 100,000 operations TV-8, 25,000 operations
G5RL-1A-E-LN		16 A, 250 VAC Resistive, 50,000 operations 16 A, 24 VDC Resistive, 50,000 operations TV-8, 25,000 operations

**VDE (EN61810-1, EN60065) (License No. A282)**

Model	Coil Rating	Contact rating
G5RL-1A-LN	5, 12, 24 VDC	12 A, 250 VAC $\cos \phi = 1$ 60,000 operations 12 A, 24 VDC (0 ms) 100,000 operations 230 VAC 70 A (0-P) Steady 1 A (L/R=0 ms) 20,000 operations 250 VAC 100 A (0-P) Steady 3 A (L/R=0 ms) 10,000 operations 250 VAC 40 A (0-P) Steady 5 A (L/R=0 ms) 10,000 operations
G5RL-1A-E-LN		16 A, 250 VAC $\cos \phi = 1$ 30,000 operations 16 A, 24 VDC (0 ms) 40,000 operations 230 VAC 70 A (0-P) Steady 1 A (L/R=0 ms) 20,000 operations 250 VAC 100 A (0-P) Steady 3 A (L/R=0 ms) 10,000 operations 250 VAC 40 A (0-P) Steady 5 A (L/R=0 ms) 10,000 operations

## Engineering Data

### Distribution of Sound Pressure

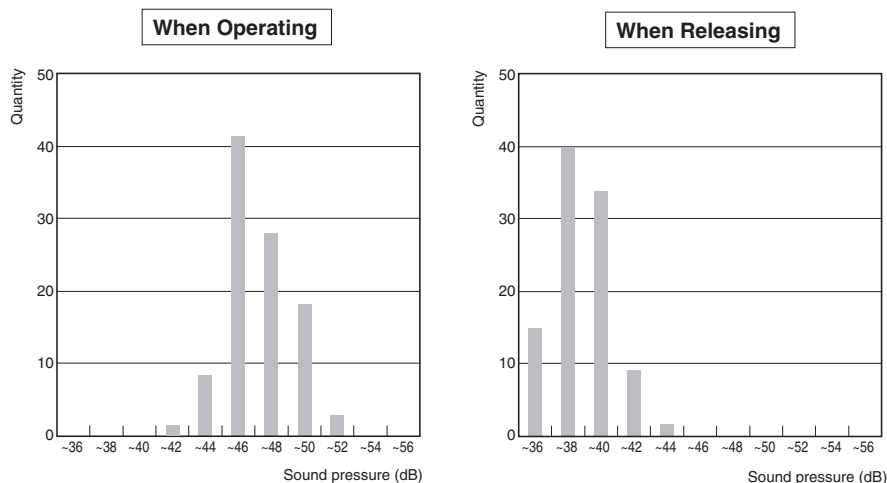

#### Measurement Conditions

Sample: G5RL-1A-LN (N = 100)  
 Range: A weighted sound pressure level, Fast, Max. hold  
 Device connected to coil: Diode  
 Background noise: Approx. 30 dB max.

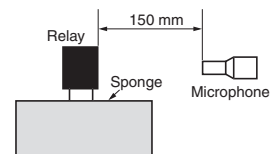

## ■ Dimensions

Note: All units are in millimeters unless otherwise indicated.

### G5RL-1A-LN

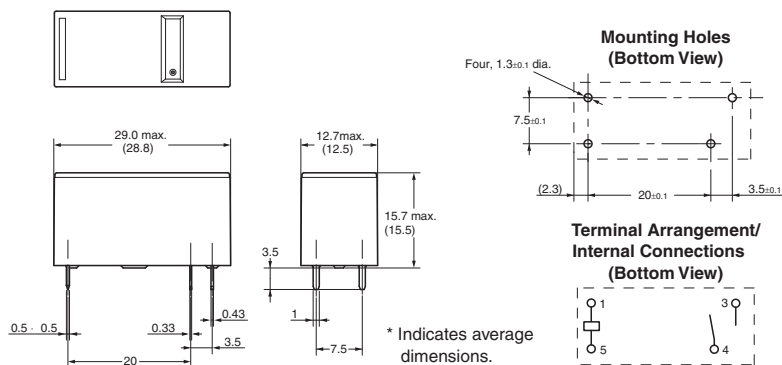
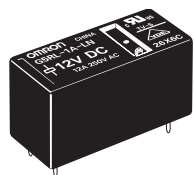

### G5RL-1A-E-LN

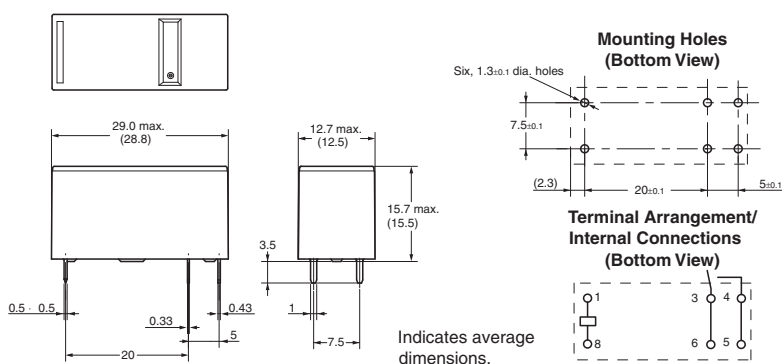
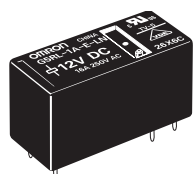

## ■ Precautions

### Mounting

When mounting a G5RL-LN Relay (Low Noise Relay) on a PCB, use a diode for surge absorption for the coil.

### Wiring

High-capacity models (-E) have a structure that connects two terminals from one contact. When designing the circuit, use both terminals. If you use only one terminal, the relay may be unable to satisfy specified performance.

### Others

Do not decrease coil voltage after operation and do not use a pulse wave drive.

#### Disclaimer:

All technical performance data applies to the product as such; specific conditions of individual applications are not considered. Always check the suitability of the product for your intended purpose. OMRON does not assume any responsibility or liability for noncompliance herein, and we recommend prior technical clarification for applications where requirements, loading, or ambient conditions differ from those applying to general electric applications. Any responsibility for the application of the product remains with the customer alone. THIS COMPONENT CAN NOT BE USED FOR AUTOMOTIVE APPLICATIONS.





All sales are subject to Omron Electronic Components LLC standard terms and conditions of sale, which can be found at [http://www.components.omron.com/components/web/webfiles.nsf/sales\\_terms.html](http://www.components.omron.com/components/web/webfiles.nsf/sales_terms.html)

**ALL DIMENSIONS SHOWN ARE IN MILLIMETERS.**

To convert millimeters into inches, multiply by 0.03937. To convert grams into ounces, multiply by 0.03527.

---

**OMRON**<sup>®</sup>

**OMRON ELECTRONIC  
COMPONENTS LLC**

55 E. Commerce Drive, Suite B  
Schaumburg, IL 60173

**847-882-2288**

**OMRON ON-LINE**

Global - <http://www.omron.com>

USA - <http://www.components.omron.com>

Cat. No. X301-E-1b

09/11

Specifications subject to change without notice

Printed in USA



Компания «ЭлектроПласт» предлагает заключение долгосрочных отношений при поставках импортных электронных компонентов на взаимовыгодных условиях!

Наши преимущества:

- Оперативные поставки широкого спектра электронных компонентов отечественного и импортного производства напрямую от производителей и с крупнейших мировых складов;
- Поставка более 17-ти миллионов наименований электронных компонентов;
- Поставка сложных, дефицитных, либо снятых с производства позиций;
- Оперативные сроки поставки под заказ (от 5 рабочих дней);
- Экспресс доставка в любую точку России;
- Техническая поддержка проекта, помощь в подборе аналогов, поставка прототипов;
- Система менеджмента качества сертифицирована по Международному стандарту ISO 9001;
- Лицензия ФСБ на осуществление работ с использованием сведений, составляющих государственную тайну;
- Поставка специализированных компонентов (Xilinx, Altera, Analog Devices, Intersil, Interpoint, Microsemi, Aeroflex, Peregrine, Syfer, Eurofarad, Texas Instrument, Miteq, Cobham, E2V, MA-COM, Hittite, Mini-Circuits, General Dynamics и др.);

Помимо этого, одним из направлений компании «ЭлектроПласт» является направление «Источники питания». Мы предлагаем Вам помощь Конструкторского отдела:

- Подбор оптимального решения, техническое обоснование при выборе компонента;
- Подбор аналогов;
- Консультации по применению компонента;
- Поставка образцов и прототипов;
- Техническая поддержка проекта;
- Защита от снятия компонента с производства.



#### Как с нами связаться

**Телефон:** 8 (812) 309 58 32 (многоканальный)

**Факс:** 8 (812) 320-02-42

**Электронная почта:** [org@eplast1.ru](mailto:org@eplast1.ru)

**Адрес:** 198099, г. Санкт-Петербург, ул. Калинина, дом 2, корпус 4, литера А.