

## Turbo 2 ultrafast high voltage rectifier

Datasheet - production data

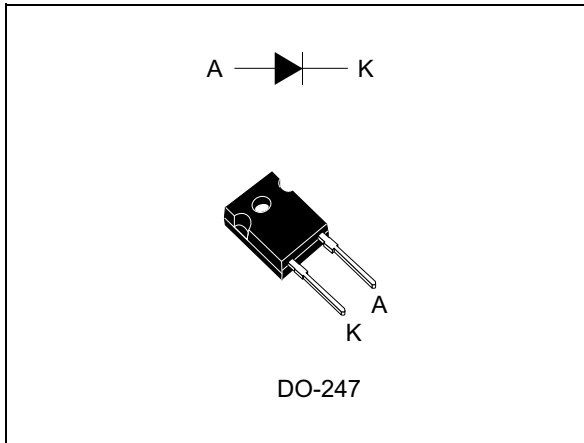

### Features

- Ultrafast switching
- Low reverse current
- Low thermal resistance
- Reduces switching and conduction losses

### Description

The STTH30ACS06W, which is ST Turbo 2 600 V technology, is suited as boost diode especially in air conditioning equipment for continuous mode interleaved power factor correction.

The device is also intended for use as a freewheeling diode in power supplies and other power switching applications.

Table 1. Device summary

Symbol	Value
$I_{F(AV)}$	30 A
$V_{RRM}$	600 V
$T_j$ (max)	175 °C
$V_F$ (typ)	1.45 V
$t_{rr}$ (max)	30 ns

# 1 Characteristics

**Table 2. Absolute ratings (limiting values at  $T_j = 25\text{ °C}$ , unless otherwise specified)**

Symbol	Parameter		Value	Unit
$V_{RRM}$	Repetitive peak reverse voltage		600	V
$I_{F(RMS)}$	RMS forward current		50	A
$I_{F(AV)}$	Average forward current		30	A
$I_{FSM}$	Surge non repetitive forward current	$t_p = 10\text{ ms}$ sinusoidal	190	A
$T_{stg}$	Storage temperature range		-65 to +175	°C
$T_j$	Maximum operating junction temperature		+175	°C

**Table 3. Thermal parameters**

Symbol	Parameter	Value	Unit
$R_{th(j-c)}$	Junction to case	1.2	°C/W

**Table 4. Static electrical characteristics**

Symbol	Parameter	Test conditions		Min.	Typ.	Max.	Unit
$I_R^{(1)}$	Reverse leakage current	$T_j = 25\text{ °C}$	$V_R = V_{RRM}$	-		5	$\mu\text{A}$
		$T_j = 150\text{ °C}$		-	30	300	
$V_F^{(2)}$	Forward voltage drop	$T_j = 25\text{ °C}$	$I_F = 30\text{ A}$	-		2.4	V
		$T_j = 150\text{ °C}$		-	1.45	1.9	

1. Pulse test:  $t_p = 5\text{ ms}$ ,  $\delta < 2\%$
2. Pulse test:  $t_p = 380\text{ }\mu\text{s}$ ,  $\delta < 2\%$

To evaluate the conduction losses use the following equation:

$$P = 1.42 \times I_{F(AV)} + 0.016 \times I_{F(RMS)}^2$$

**Table 5. Dynamic electrical characteristics**

Symbol	Parameter	Test conditions		Min.	Typ.	Max.	Unit
$t_{rr}$	Reverse recovery time	$T_j = 25\text{ °C}$	$I_F = 0.5\text{ A}$ , $I_{rr} = 0.25\text{ A}$ , $I_R = 1\text{ A}$			30	ns
			$I_F = 1\text{ A}$ , $V_R = 30\text{ V}$ , $dI_F/dt = -50\text{ A}/\mu\text{s}$		40	55	ns
$I_{RM}$	Reverse recovery current	$T_j = 125\text{ °C}$	$I_F = 30\text{ A}$ , $dI_F/dt = 200\text{ A}/\mu\text{s}$ , $V_R = 400\text{ V}$		7.8	10.5	A
$t_{fr}$	Forward recovery time	$T_j = 25\text{ °C}$	$I_F = 30\text{ A}$ , $dI_F/dt = 200\text{ A}/\mu\text{s}$ , $V_{FR} = 2.8\text{ V}$			300	ns
$V_{FP}$	Forward recovery voltage				3.5		V

**Figure 1. Average forward power dissipation versus average forward current**

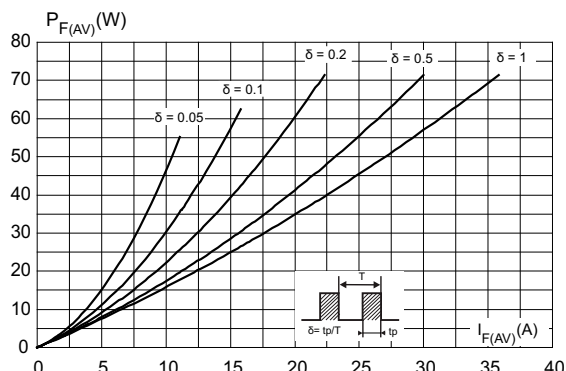

**Figure 2. Forward voltage drop versus forward current (typical values)**

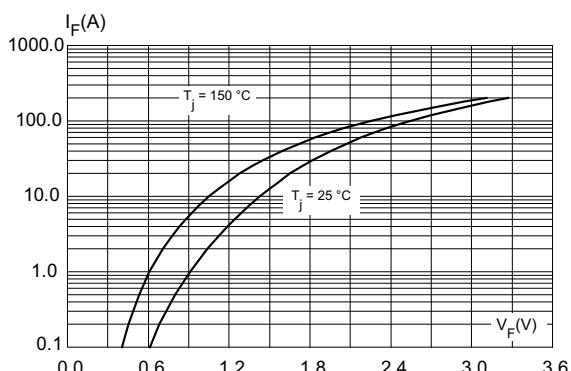

**Figure 3. Forward voltage drop versus forward current (maximum values)**

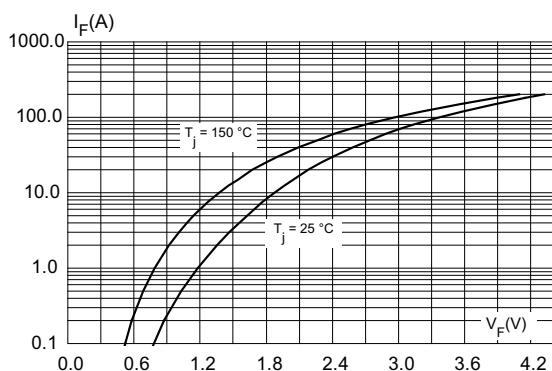

**Figure 4. Relative variation of thermal impedance junction to case versus pulse duration**

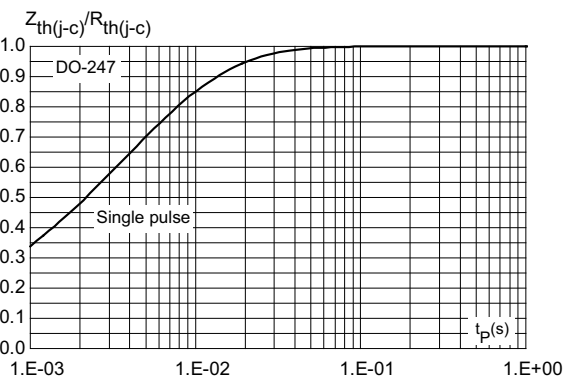

**Figure 5. Peak reverse recovery current versus  $di_F/dt$  (typical values)**

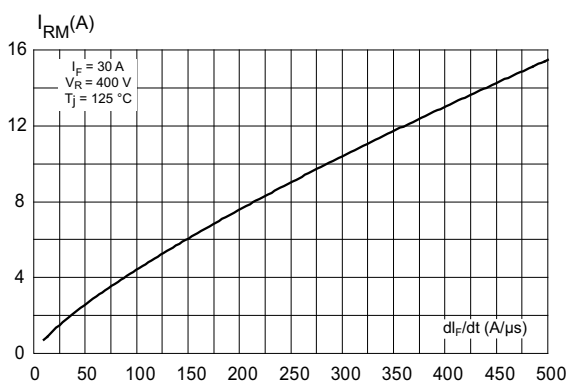

**Figure 6. Reverse recovery time versus  $di_F/dt$  (typical values)**

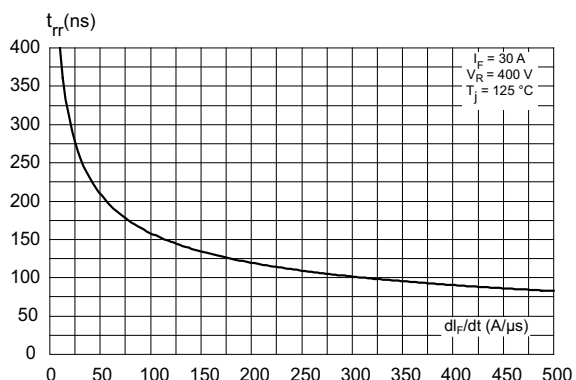

**Figure 7. Reverse recovery charges versus  $di_F/dt$  (typical values)**

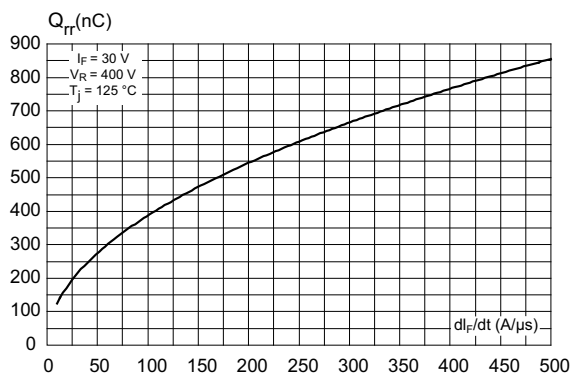

**Figure 8. Softness factor versus  $di_F/dt$  (typical values)**

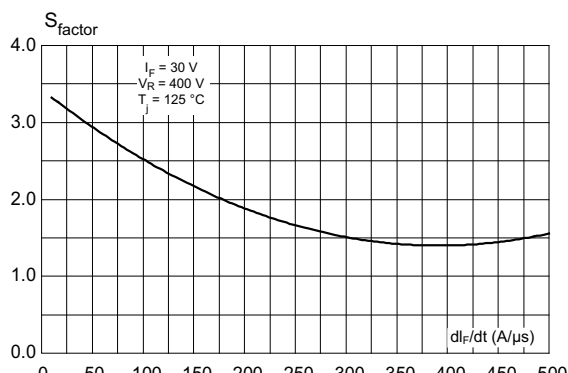

**Figure 9. Relative variations of dynamic parameters versus junction temperature**

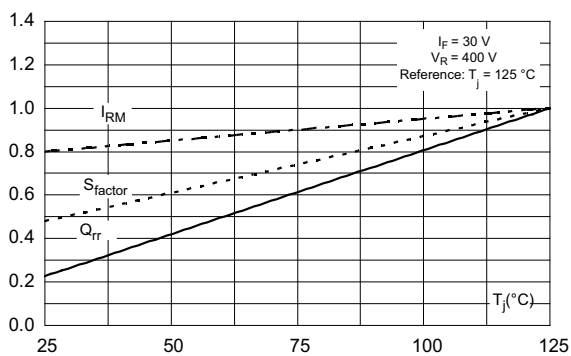

**Figure 10. Transient peak forward voltage versus  $di_F/dt$  (typical values)**

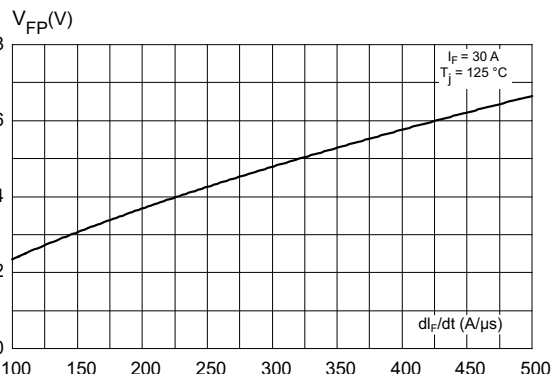

**Figure 11. Forward recovery time versus  $di_F/dt$  (typical values)**

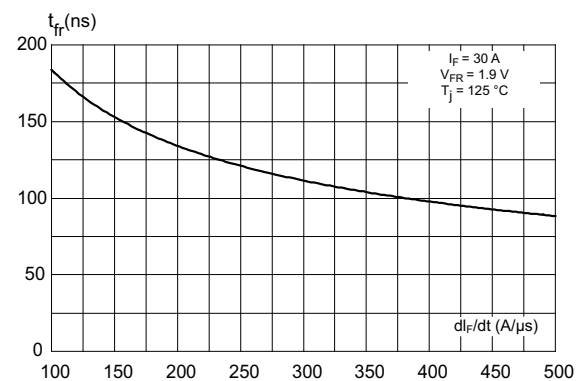

**Figure 12. Junction capacitance versus reverse voltage applied (typical values)**

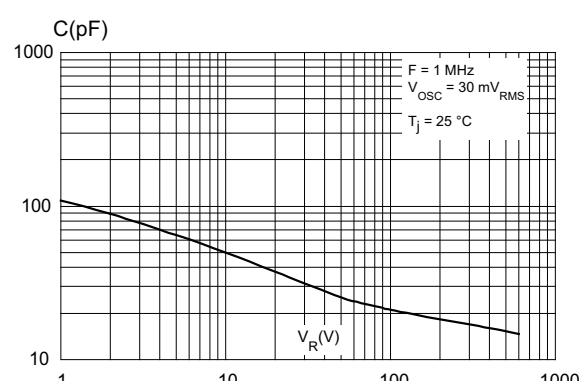

## 2 Package information

- Epoxy meets UL94, V0
- Cooling method by conduction (C)
- Recommended torque value: 0.8 N·m
- Maximum torque value: 1.0 N·m

In order to meet environmental requirements, ST offers these devices in different grades of ECOPACK® packages, depending on their level of environmental compliance. ECOPACK® specifications, grade definitions and product status are available at: [www.st.com](http://www.st.com). ECOPACK® is an ST trademark.

### 2.1 DO-247 package information

Figure 13. DO-247 package outline

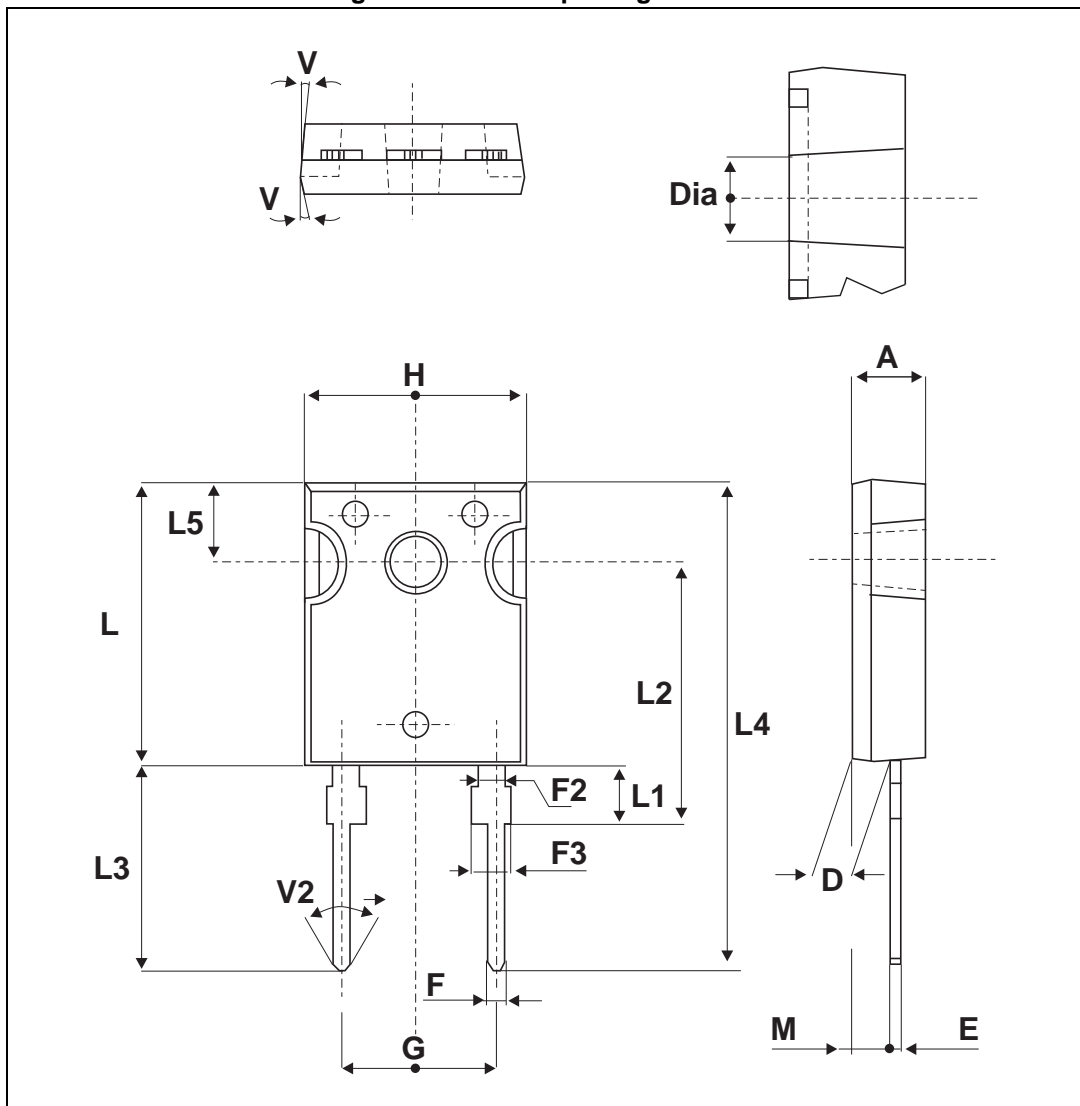

Table 6. DO-247 package mechanical data

Ref.	Dimensions					
	Millimeters			Inches		
	Min.	Typ.	Max.	Min.	Typ.	Max.
A	4.85		5.15	0.191		0.203
D	2.20		2.60	0.086		0.102
E	0.40		0.80	0.015		0.031
F	1.00		1.40	0.039		0.055
F2		2.00			0.078	
F3	2.00		2.40	0.078		0.094
G		10.90			0.429	
H	15.45		15.75	0.608		0.620
L	19.85		20.15	0.781		0.793
L1	3.70		4.30	0.145		0.169
L2		18.50			0.728	
L3	14.20		14.80	0.559		0.582
L4		34.60			1.362	
L5		5.50			0.216	
M	2.00		3.00	0.078		0.118
V		5°			5°	
V2		60°			60°	
Dia.	3.55		3.65	0.139		0.143

### 3 Ordering information

Table 7. Ordering information

Order code	Marking	Package	Weight	Base qty	Delivery mode
STTH30ACS06W	STTH30ACS06W	DO-247	1.8 g	50	Tube

### 4 Revision history

Table 8. Document revision history

Date	Revision	Changes
22-Sep-2015	1	First issue.

**IMPORTANT NOTICE – PLEASE READ CAREFULLY**

STMicroelectronics NV and its subsidiaries ("ST") reserve the right to make changes, corrections, enhancements, modifications, and improvements to ST products and/or to this document at any time without notice. Purchasers should obtain the latest relevant information on ST products before placing orders. ST products are sold pursuant to ST's terms and conditions of sale in place at the time of order acknowledgement.

Purchasers are solely responsible for the choice, selection, and use of ST products and ST assumes no liability for application assistance or the design of Purchasers' products.

No license, express or implied, to any intellectual property right is granted by ST herein.

Resale of ST products with provisions different from the information set forth herein shall void any warranty granted by ST for such product.

ST and the ST logo are trademarks of ST. All other product or service names are the property of their respective owners.

Information in this document supersedes and replaces information previously supplied in any prior versions of this document.

© 2015 STMicroelectronics – All rights reserved





Компания «ЭлектроПласт» предлагает заключение долгосрочных отношений при поставках импортных электронных компонентов на взаимовыгодных условиях!

Наши преимущества:

- Оперативные поставки широкого спектра электронных компонентов отечественного и импортного производства напрямую от производителей и с крупнейших мировых складов;
- Поставка более 17-ти миллионов наименований электронных компонентов;
- Поставка сложных, дефицитных, либо снятых с производства позиций;
- Оперативные сроки поставки под заказ (от 5 рабочих дней);
- Экспресс доставка в любую точку России;
- Техническая поддержка проекта, помощь в подборе аналогов, поставка прототипов;
- Система менеджмента качества сертифицирована по Международному стандарту ISO 9001;
- Лицензия ФСБ на осуществление работ с использованием сведений, составляющих государственную тайну;
- Поставка специализированных компонентов (Xilinx, Altera, Analog Devices, Intersil, Interpoint, Microsemi, Aeroflex, Peregrine, Syfer, Eurofarad, Texas Instrument, Miteq, Cobham, E2V, MA-COM, Hittite, Mini-Circuits, General Dynamics и др.);

Помимо этого, одним из направлений компании «ЭлектроПласт» является направление «Источники питания». Мы предлагаем Вам помощь Конструкторского отдела:

- Подбор оптимального решения, техническое обоснование при выборе компонента;
- Подбор аналогов;
- Консультации по применению компонента;
- Поставка образцов и прототипов;
- Техническая поддержка проекта;
- Защита от снятия компонента с производства.



#### Как с нами связаться

**Телефон:** 8 (812) 309 58 32 (многоканальный)

**Факс:** 8 (812) 320-02-42

**Электронная почта:** [org@eplast1.ru](mailto:org@eplast1.ru)

**Адрес:** 198099, г. Санкт-Петербург, ул. Калинина, дом 2, корпус 4, литера А.