

## Applications

- W-CDMA / LTE
- Macrocell Base Station, Band 1 and Band 3
- Active Antenna
- General Purpose Applications



2 Lead NI400 Package

## Product Features

- Operating Frequency Range: 1.8-2.4 GHz
- Operating Drain Voltage: 48 V
- Maximum Output Power ( $P_{SAT}$ ): 227 W
- Maximum Drain Efficiency: 77.5%
- Efficiency-Tuned P3dB Gain: 21 dB
- 2-lead, earless, ceramic flange NI400 package

## Functional Block Diagram

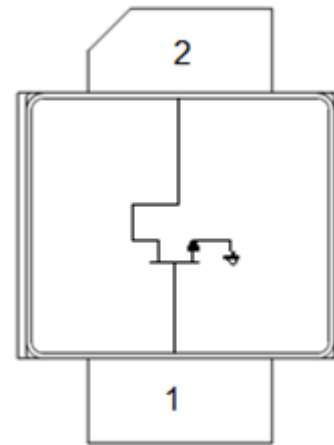

## General Description

The QPD1823 is a discrete GaN on SiC HEMT which operates from 1.8-2.4 GHz. The device is a single stage matched power amplifier transistor.

The QPD1823 can be used in Doherty architecture for the final stage of a base station power amplifier for macrocell high efficiency systems.

QPD1823 can deliver  $P_{SAT}$  of 227 W at 48 V operation.

Lead-free and ROHS compliant.

## Pin Configuration

Pin No.	Label
1	RF IN, $V_G$
2	RF OUT, $V_D$
Backside Paddle	RF/DC Ground

## Ordering Information

Part No.	ECCN	Description
QPD1823	EAR99	220 W, 1.8-2.4 GHz, GaN RF Transistor

### Absolute Maximum Ratings

Parameter	Rating
Gate Voltage ( $V_G$ )	-10 V
Drain Voltage ( $V_D$ )	+55 V
Peak RF Input Power	42 dBm
VSWR Mismatch, P1dB Pulse (20% duty cycle, 100 $\mu$ width), $T = 25^\circ\text{C}$	10:1
Storage Temperature	-65 to +150 $^\circ\text{C}$

Operation of this device outside the parameter ranges given above may cause permanent damage.

### Recommended Operating Conditions

Parameter	Min	Typ	Max	Units
Operating Temperature	-40			$^\circ\text{C}$
Gate Voltage ( $V_G$ )		-2.9		V
Drain Voltage ( $V_D$ )		48		V
Quiescent Current ( $I_{CQ}$ )		360		mA
$T_{CH}$ for $>10^6$ hours MTTF			225	$^\circ\text{C}$

Electrical performance is measured under conditions noted in the electrical specifications table. Specifications are not guaranteed over all recommended operating conditions.

### RF Characterization – Power-Tuned Load Pull Performance

Test conditions unless otherwise noted:  $V_D = 48$  V,  $I_{DQ} = 360$  mA,  $T = 25^\circ\text{C}$ , Pulsed (10% duty cycle, 100  $\mu\text{s}$  width)

Frequency (MHz)	Source Impedance	Load Impedance	Gain @ P3dB (dB)	P3dB (dBm)	Drain Efficiency (%)
1800	7.13+j5.82	6.23-j1.20	19.63	53.53	65.55
1840	6.22+j5.03	6.72-j1.00	19.79	53.47	64.12
1880	4.16+j3.94	6.78-j1.24	20.18	53.40	65.09
2110	1.63-j1.40	8.62+j2.17	19.18	53.41	61.05
2140	2.16 - j1.42	7.89+j2.05	19.50	53.42	64.27
2170	2.05 - j1.99	6.97+j2.33	19.21	53.29	63.51

### RF Characterization – Efficiency-Tuned Load Pull Performance

Test conditions unless otherwise noted:  $V_D = 48$  V,  $I_{DQ} = 360$  mA,  $T = 25^\circ\text{C}$ , Pulsed (10% duty cycle, 100  $\mu\text{s}$  width)

Frequency (MHz)	Source Impedance	Load Impedance	Gain @ P3dB (dB)	P3dB (dBm)	Drain Efficiency (%)
1800	7.13+j5.82	3.28+j1.19	21.12	52.32	77.42
1840	6.22+j5.03	3.16-j1.36	21.38	51.80	76.14
1880	4.16+j3.94	3.72-j1.30	21.37	52.12	75.13
2110	1.63-j1.40	6.43-j1.87	21.06	52.48	73.51
2140	2.16 - j1.42	5.67-j1.99	21.14	51.87	74.90
2170	2.05 - j1.99	6.08-j1.95	20.95	51.95	74.40

**Thermal Information**

Parameter	Conditions	Value	Units
Thermal Resistance at Average Power ( $\theta_{JC}$ )	$T_{CASE} = 85^{\circ}C$ , $T_{CH} = 122^{\circ}C$ CW: $P_{DISS} = 29 W$ , $P_{OUT} = 50 W$	1.3	$^{\circ}C/W$

Notes:

1. Thermal resistance measured to package backside.
2. Based on expected carrier amplifier efficiency of Doherty.
3. Pout assumes 20% peaking amplifier contribution of total average Doherty rated power.

**Median Lifetime**

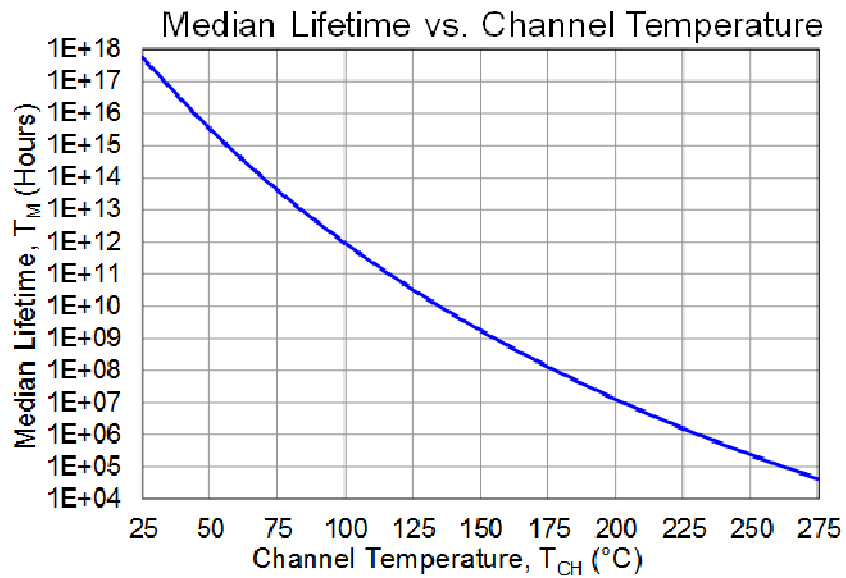

**Load Pull Plots**

Test conditions unless otherwise noted:  $V_D = 48\text{ V}$ ,  $I_{CQ} = 360\text{ mA}$ ,  $T = 25^\circ\text{C}$ , Pulsed (10% duty cycle, 100  $\mu\text{s}$  width)

Load Pull at 1.8 GHz

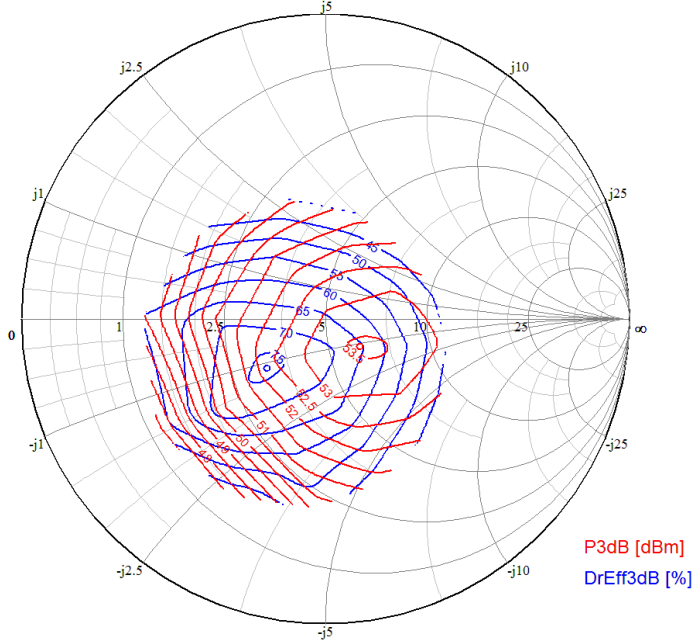

Load Pull at 1.84 GHz

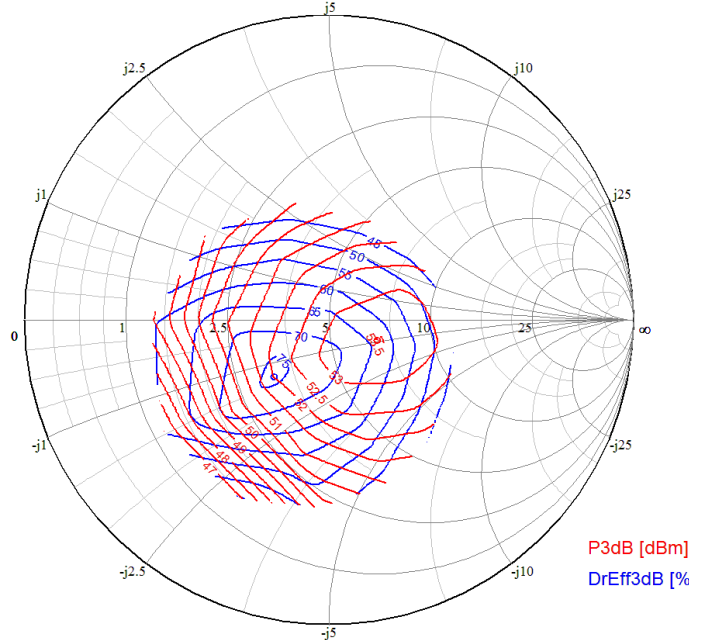

Load Pull at 1.88 GHz

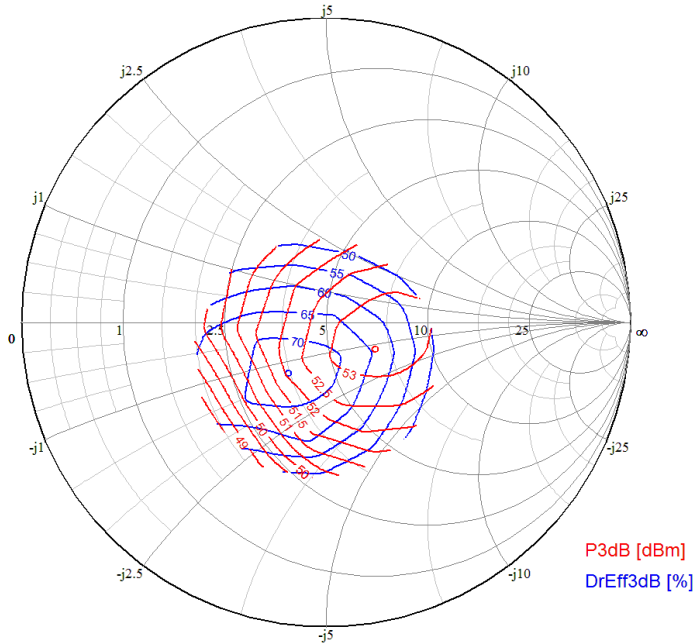

Load Pull at 2.11 GHz

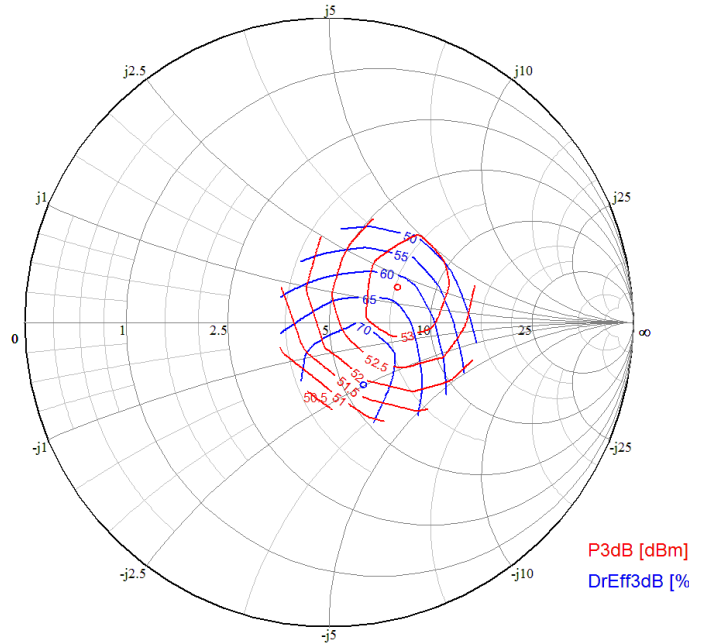

### Load Pull Plots

Test conditions unless otherwise noted:  $V_{G1} = -2.9$  V,  $V_{D1} = 48$  V,  $I_{CQ1} = 360$  mA,  $T = 25^{\circ}\text{C}$ , Pulsed (10% duty cycle, 100  $\mu\text{s}$  width)

Load Pull at 2.14 GHz

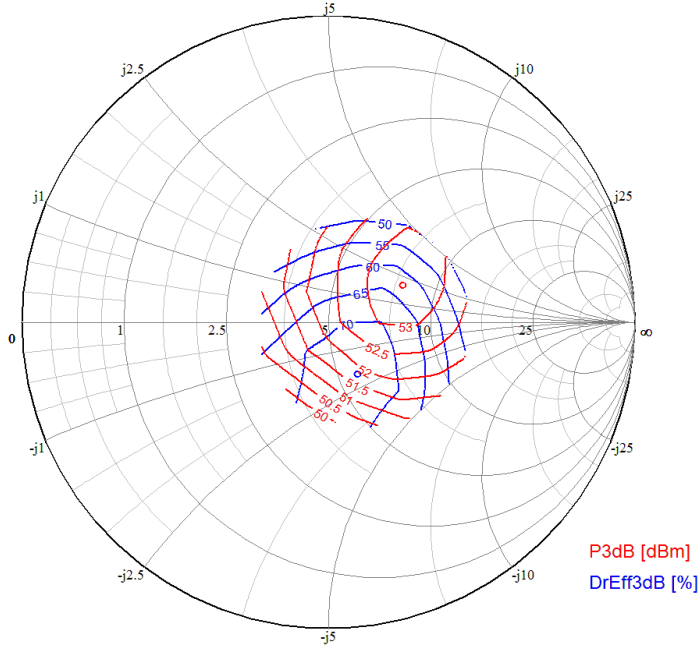

Load Pull at 2.17 GHz

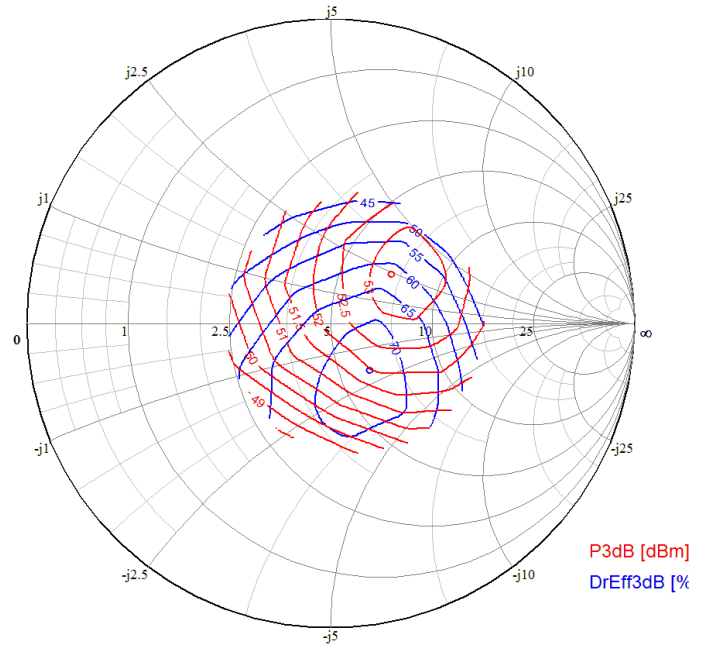

**Pin Configuration and Description**



TOP VIEW

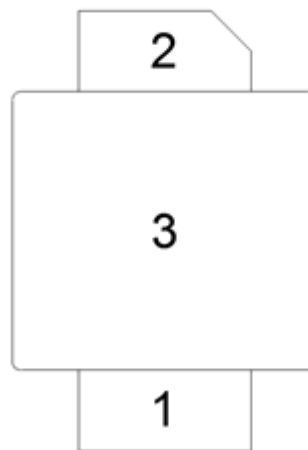

BOTTOM VIEW

Pin No.	Label	Description
1	RF IN, $V_G$	RF Input, Gate Bias
2	RF OUT, $V_D$	RF Output, Drain Bias
3 (Backside Paddle)	RF/DC GND	RF/DC Ground

Package Marking and Dimensions

Marking: Product Name – QPD1823  
 Year/Week Code– YYWW  
 Production Lot Number – MXXX  
 Serial Number – ZZZ

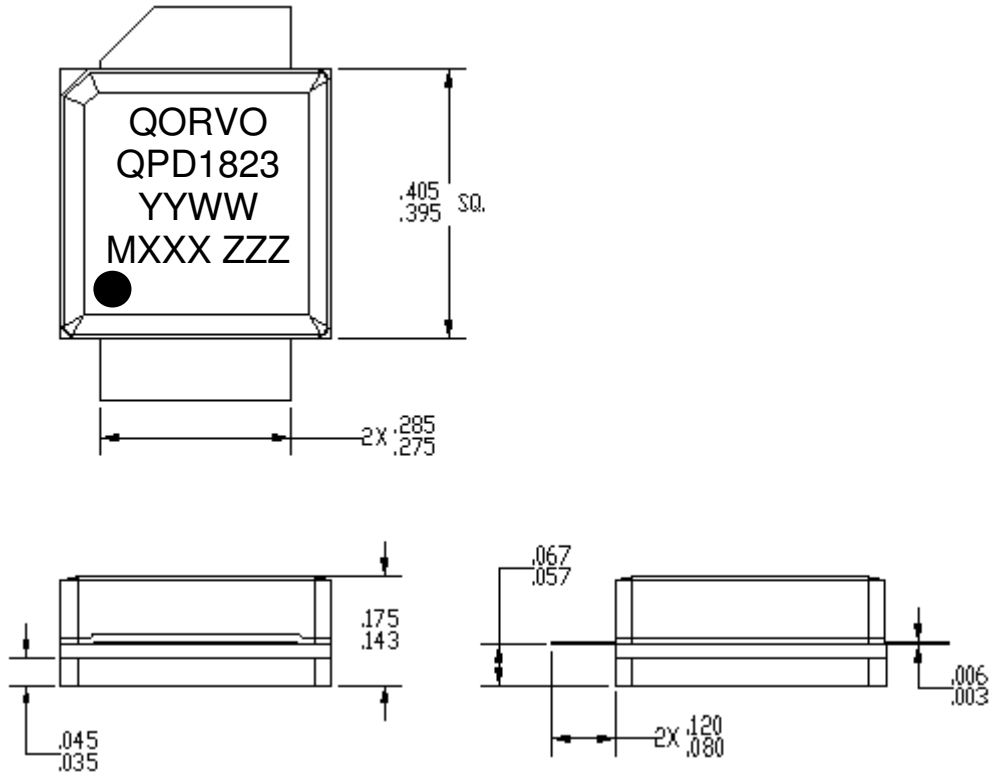

- Notes:
1. All dimensions are in inches. Angles are in degrees.
  2. Exposed metallization is NiAu plated.

## Product Compliance Information

### ESD Sensitivity Ratings



Caution! ESD-Sensitive Device

ESD Class: TBD

Volt. Range: TBD

Test: Human Body Model (HBM)

Standard: JEDEC Standard JS-001-2012

ESD Class: TBD

Range: TBD

Test: Charged Device Model (CDM)

Standard: JEDEC Standard JESD22-C101F

### MSL Rating

MSL Rating: TBD

Test: 260 °C convection reflow

Standard: JEDEC Standard IPC/JEDEC J-STD-020

### ECCN

US Department of Commerce EAR99

### Solderability

Compatible with both lead-free (260 °C maximum reflow temperature) and tin/lead (245 °C maximum reflow temperature) soldering processes.

Contact plating: NiAu

### RoHS Compliance

This part is compliant with EU 2002/95/EC RoHS directive (Restrictions on the Use of Certain Hazardous Substances in Electrical and Electronic Equipment).

This product also has the following attributes:

- Lead Free
- Antimony Free
- TBBP-A (C<sub>15</sub>H<sub>12</sub>Br<sub>4</sub>O<sub>2</sub>) Free
- PFOS Free
- SVHC Free

## Contact Information

For the latest specifications, additional product information, worldwide sales and distribution locations:

Web: [www.triquint.com](http://www.triquint.com)

Tel: 877-800-8584

Email: [customer.support@qorvo.com](mailto:customer.support@qorvo.com)

For information about the merger of RFMD and TriQuint as Qorvo:

Web: [www.qorvo.com](http://www.qorvo.com)

For technical questions and application information:

Email: [btsapplications@qorvo.com](mailto:btsapplications@qorvo.com)

## Important Notice

The information contained herein is believed to be reliable. TriQuint makes no warranties regarding the information contained herein. TriQuint assumes no responsibility or liability whatsoever for any of the information contained herein. TriQuint assumes no responsibility or liability whatsoever for the use of the information contained herein. The information contained herein is provided "AS IS, WHERE IS" and with all faults, and the entire risk associated with such information is entirely with the user. All information contained herein is subject to change without notice. Customers should obtain and verify the latest relevant information before placing orders for TriQuint products. The information contained herein or any use of such information does not grant, explicitly or implicitly, to any party any patent rights, licenses, or any other intellectual property rights, whether with regard to such information itself or anything described by such information.

TriQuint products are not warranted or authorized for use as critical components in medical, life-saving, or life-sustaining applications, or other applications where a failure would reasonably be expected to cause severe personal injury or death.





Компания «ЭлектроПласт» предлагает заключение долгосрочных отношений при поставках импортных электронных компонентов на взаимовыгодных условиях!

Наши преимущества:

- Оперативные поставки широкого спектра электронных компонентов отечественного и импортного производства напрямую от производителей и с крупнейших мировых складов;
- Поставка более 17-ти миллионов наименований электронных компонентов;
- Поставка сложных, дефицитных, либо снятых с производства позиций;
- Оперативные сроки поставки под заказ (от 5 рабочих дней);
- Экспресс доставка в любую точку России;
- Техническая поддержка проекта, помощь в подборе аналогов, поставка прототипов;
- Система менеджмента качества сертифицирована по Международному стандарту ISO 9001;
- Лицензия ФСБ на осуществление работ с использованием сведений, составляющих государственную тайну;
- Поставка специализированных компонентов (Xilinx, Altera, Analog Devices, Intersil, Interpoint, Microsemi, Aeroflex, Peregrine, Syfer, Eurofarad, Texas Instrument, Miteq, Cobham, E2V, MA-COM, Hittite, Mini-Circuits, General Dynamics и др.);

Помимо этого, одним из направлений компании «ЭлектроПласт» является направление «Источники питания». Мы предлагаем Вам помощь Конструкторского отдела:

- Подбор оптимального решения, техническое обоснование при выборе компонента;
- Подбор аналогов;
- Консультации по применению компонента;
- Поставка образцов и прототипов;
- Техническая поддержка проекта;
- Защита от снятия компонента с производства.



#### Как с нами связаться

**Телефон:** 8 (812) 309 58 32 (многоканальный)

**Факс:** 8 (812) 320-02-42

**Электронная почта:** [org@eplast1.ru](mailto:org@eplast1.ru)

**Адрес:** 198099, г. Санкт-Петербург, ул. Калинина, дом 2, корпус 4, литера А.