

High frequency secondary rectifier

Datasheet - production data

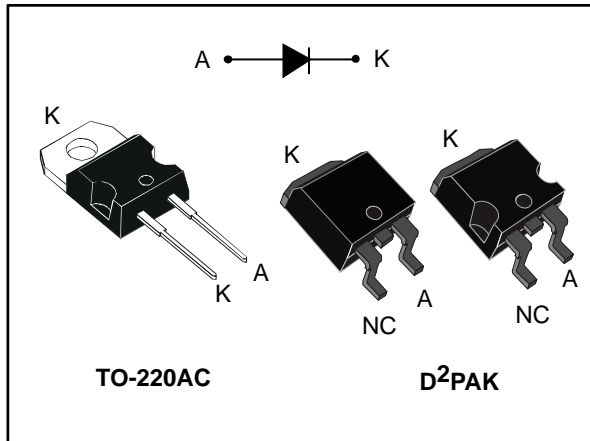

Features

- Combines highest recovery and reverse voltage performance
- Ultra-fast, soft and noise-free recovery
- ECOPACK[®]2 compliant component for D²PAK on demand

Description

Single fast recovery epitaxial diode suited for switch mode power supply and high frequency DC/DC converters. Packaged in TO-220AC or D²PAK this device is especially intended for secondary rectification.

Table 1: Device summary

Symbol	Value
$I_{F(AV)}$	8 A
V_{RRM}	300 V
T_j (max)	175 °C
V_F (typ)	0.85 V
t_{rr} (max)	25 ns

1 Characteristics

Table 2: Absolute ratings (limiting values at 25 °C, unless otherwise specified)

Symbol	Parameter		Value	Unit
V _{RRM}	Repetitive peak reverse voltage		300	V
I _{F(RMS)}	Forward rms current		20	A
I _{F(AV)}	Average forward current $\delta = 0.5$, square wave	T _C = 150 °C	8	A
I _{FSM}	Surge non repetitive forward current	t _p = 10 ms sinusoidal	100	A
T _{stg}	Storage temperature range		-65 to + 175	°C
T _j	Maximum operating junction temperature		+ 175	°C

Table 3: Thermal parameter

Symbol	Parameter	Value	Unit
R _{th(j-c)}	Junction to case	2.5	°C/W

Table 4: Static electrical characteristics

Symbol	Parameter	Test conditions		Min.	Typ.	Max.	Unit
I _R ⁽¹⁾	Reverse leakage current	T _j = 25 °C	V _R = 300 V	-		20	µA
		T _j = 125 °C		-	20	200	
V _F ⁽²⁾	Forward voltage drop	T _j = 25 °C	I _F = 8 A	-		1.25	V
		T _j = 125 °C		-	0.85	1	

Notes:

⁽¹⁾Pulse test: t_p = 5 ms, $\delta < 2\%$

⁽²⁾Pulse test: t_p = 380 µs, $\delta < 2\%$

To evaluate the conduction losses use the following equation:

$$P = 0.75 \times I_{F(AV)} + 0.031 I_{F(RMS)}^2$$

Table 5: Dynamic electrical characteristics

Symbol	Parameter	Test conditions		Min.	Typ.	Max.	Unit
t _{rr}	Reverse recovery time	T _j = 25 °C	I _F = 0.5 A, I _{rr} = 0.25 A, I _R = 1 A	-		25	ns
			I _F = 1 A, dI _F /dt = -50 A/µs, V _R = 30 V	-		35	
t _{fr}	Forward recovery time	T _j = 25 °C	I _F = 8 A, dI _F /dt = -100 A/µs, V _{FR} = 1.1 x V _{Fmax}	-		200	ns
V _{FP}	Forward recovery voltage	T _j = 25 °C		-		3.5	V
S _{factor}	Softness factor	T _j = 125 °C	I _F = 8 A, V _{CC} = 200 V	-	0.3		
I _{RM}	Reverse recovery current	T _j = 125 °C		dI _F /dt = 200 A/µs	-		8

1.1 Characteristics (curves)

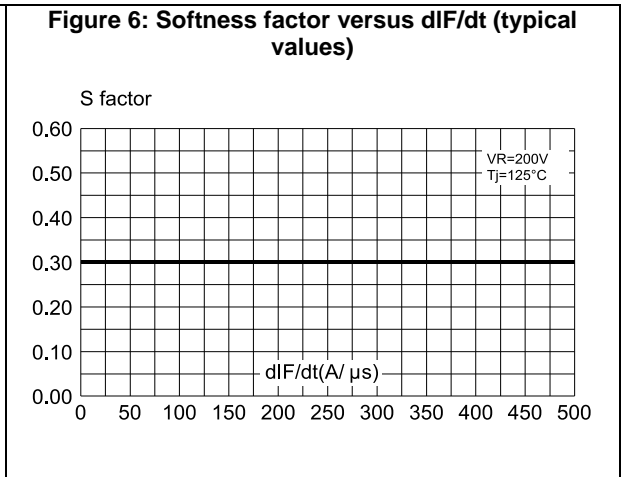
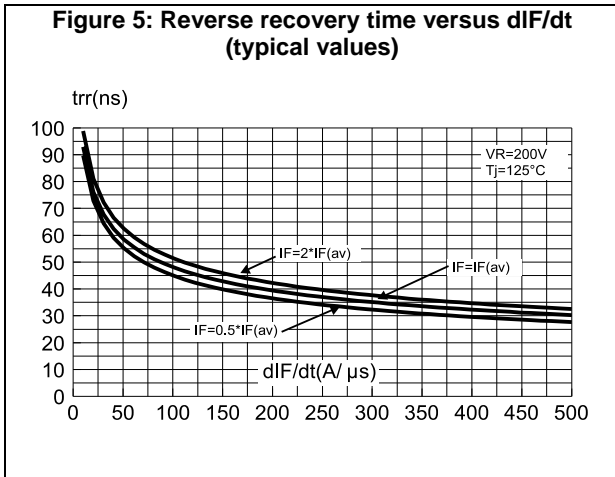
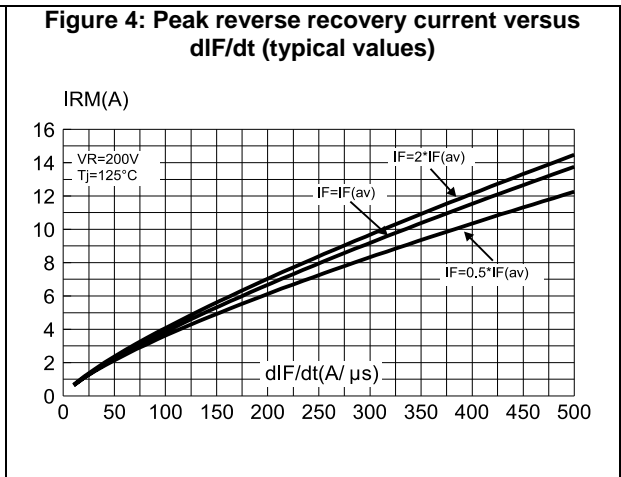
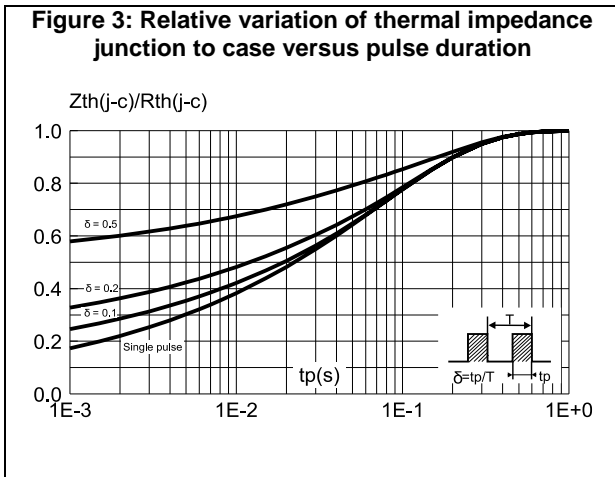
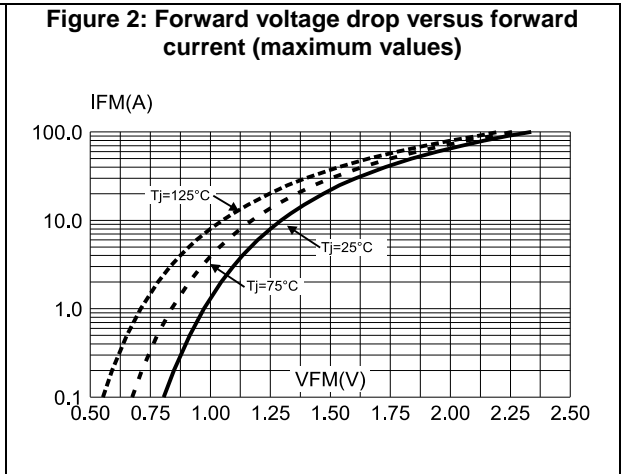
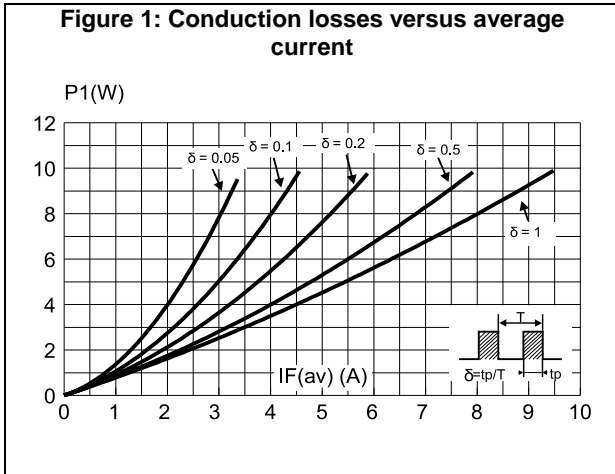

Figure 7: Relative variation of dynamic parameters versus junction temperature (reference: $T_j = 125\text{ }^\circ\text{C}$)

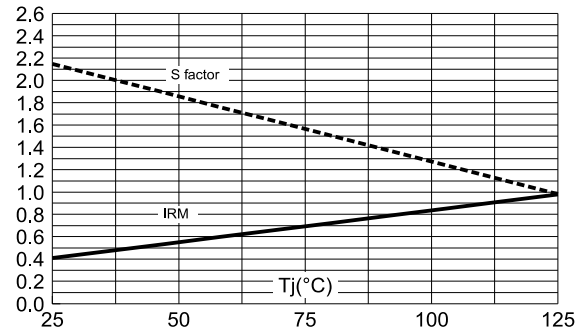

Figure 8: Transient peak forward voltage versus dI_F/dt (typical values)

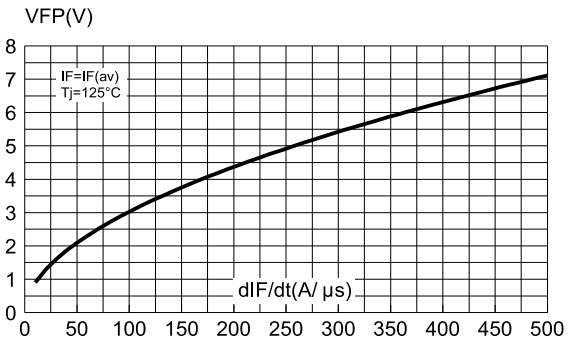
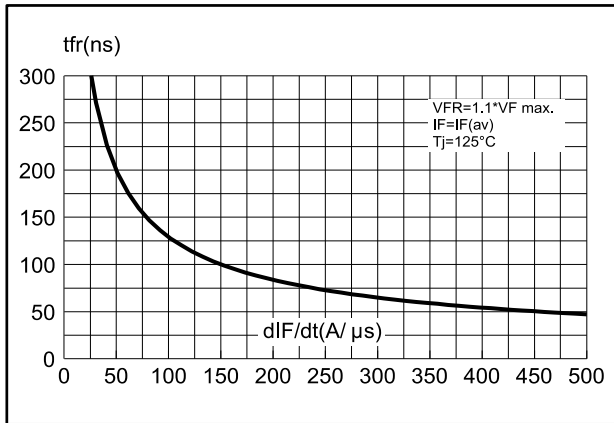

Figure 9: Forward recovery time versus dI_F/dt (typical values)



2 Package information

In order to meet environmental requirements, ST offers these devices in different grades of ECOPACK® packages, depending on their level of environmental compliance. ECOPACK® specifications, grade definitions and product status are available at: www.st.com. ECOPACK® is an ST trademark.

- Cooling method: by conduction (C)
- Recommended torque value (TO-220AC): 0.55 N.m.
- Maximum torque value (TO-220AC): 0.70 N.m.
- Epoxy meets UL 94,V0

2.1 D²PAK package information

Figure 10: D²PAK package outline

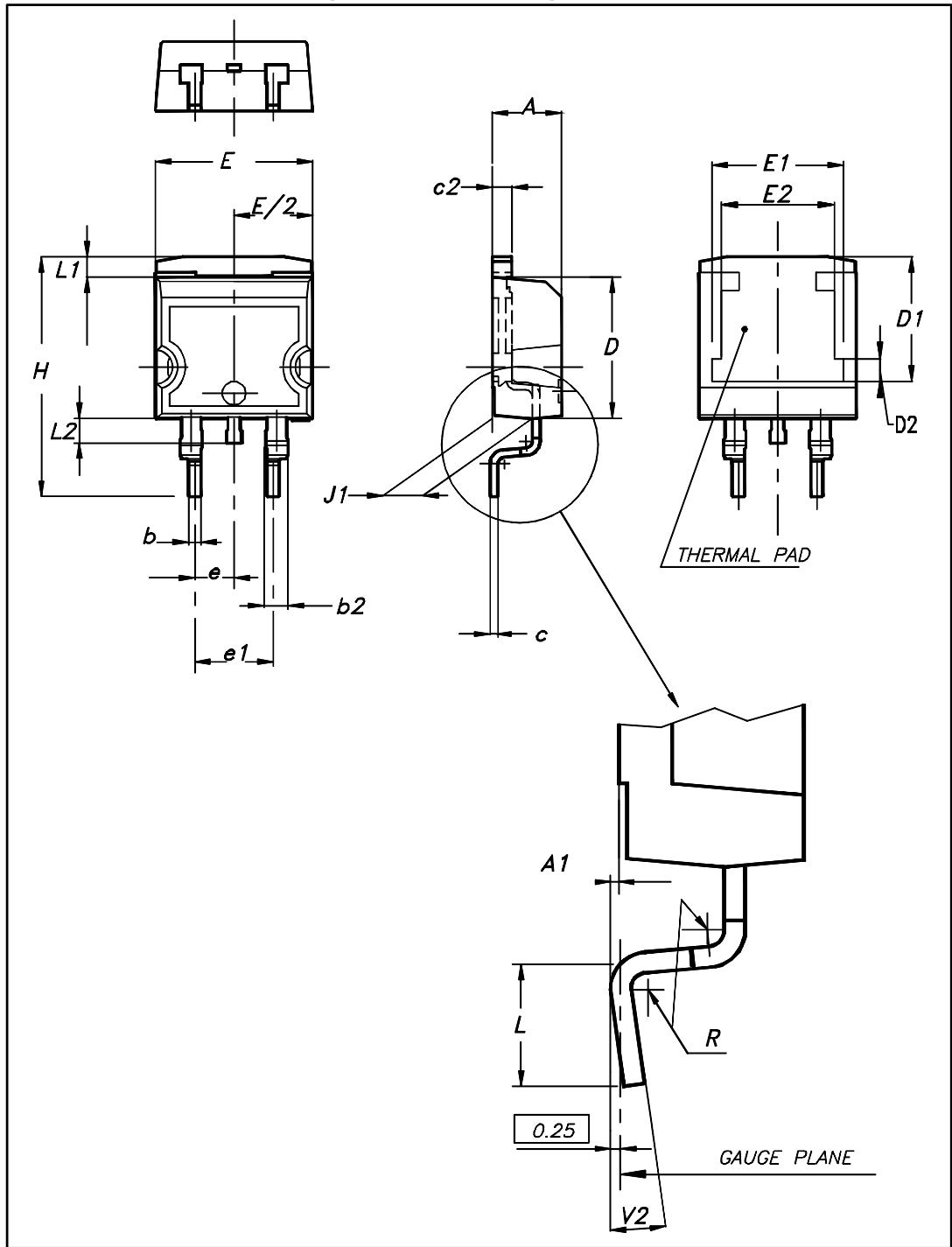

This package drawing may slightly differ from the physical package. However, all the specified dimensions are guaranteed.

Table 6: D²PAK package mechanical data

Ref.	Dimensions			
	Millimeters		Inches	
	Min.	Max.	Min.	Max.
A	4.36	4.60	0.172	0.181
A1	0.00	0.25	0.000	0.010
b	0.70	0.93	0.028	0.037
b2	1.14	1.70	0.045	0.067
c	0.38	0.69	0.015	0.027
c2	1.19	1.36	0.047	0.053
D	8.60	9.35	0.339	0.368
D1	6.90	8.00	0.272	0.311
D2	1.10	1.50	0.043	0.060
E	10.00	10.55	0.394	0.415
E1	8.10	8.90	0.319	0.346
E2	6.85	7.25	0.266	0.282
e	2.54 typ.		0.100	
e1	4.88	5.28	0.190	0.205
H	15.00	15.85	0.591	0.624
J1	2.49	2.90	0.097	0.112
L	1.90	2.79	0.075	0.110
L1	1.27	1.65	0.049	0.065
L2	1.30	1.78	0.050	0.070
R	0.4 typ.		0.015	
V2	0°	8°	-	-

Figure 11: D²PAK recommended footprint (dimensions in mm)

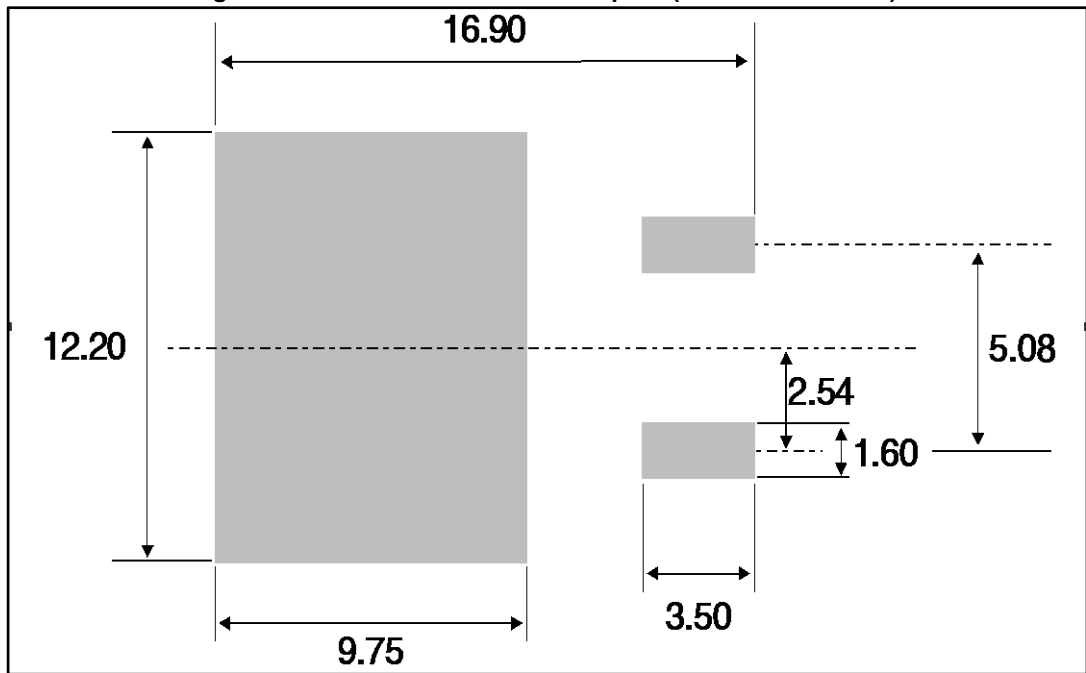

2.2 TO-220AC package information

Figure 12: TO-220AC package outline

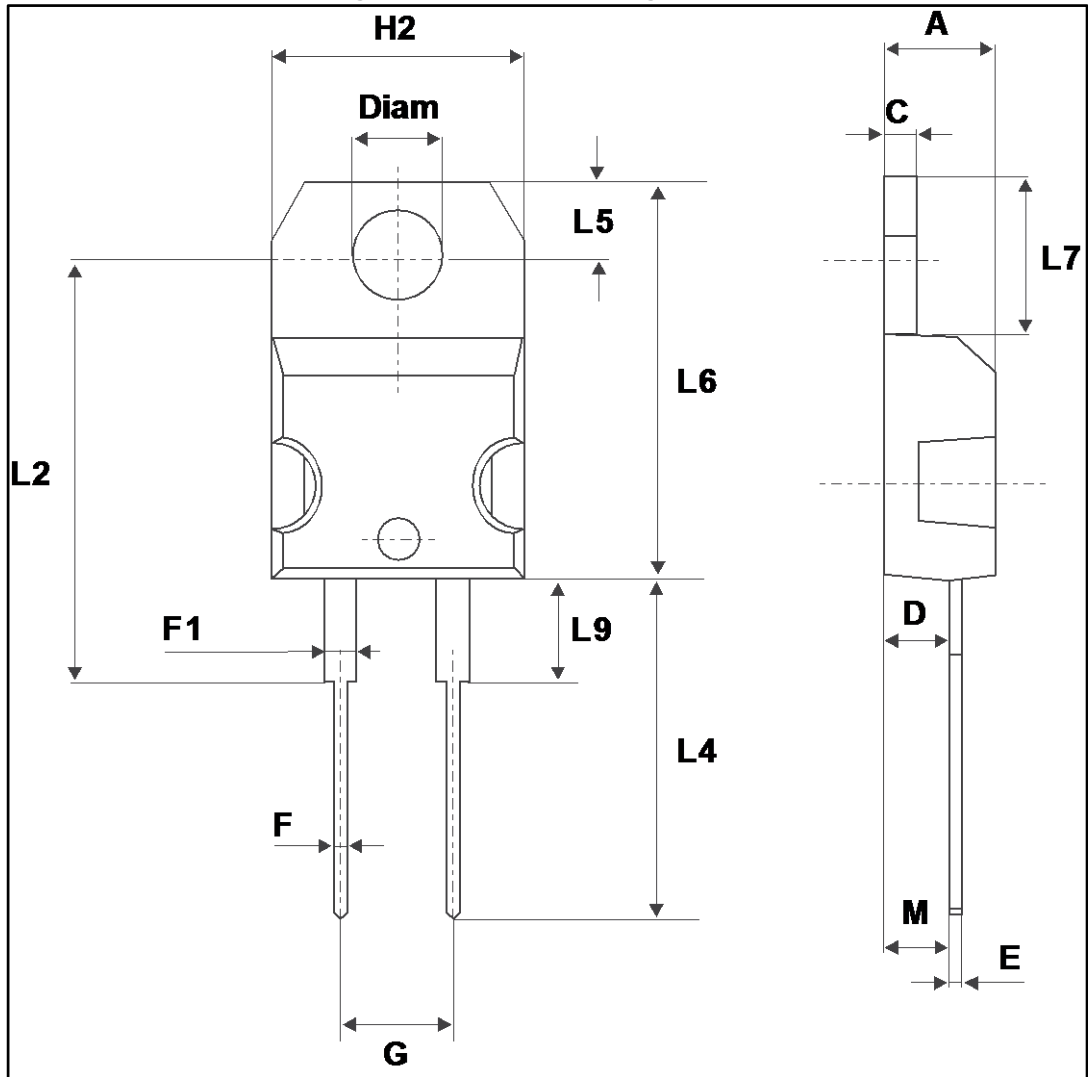

Table 7: TO-220AC package mechanical data

Ref.	Dimensions			
	Millimeters		Inches	
	Min.	Max.	Min.	Max.
A	4.40	4.60	0.173	0.181
C	1.23	1.32	0.048	0.051
D	2.40	2.72	0.094	0.107
E	0.49	0.70	0.019	0.027
F	0.61	0.88	0.024	0.034
F1	1.14	1.70	0.044	0.066
G	4.95	5.15	0.194	0.202
H2	10.00	10.40	0.393	0.409
L2	16.40 typ.		0.645 typ.	
L4	13.00	14.00	0.511	0.551
L5	2.65	2.95	0.104	0.116
L6	15.25	15.75	0.600	0.620
L7	6.20	6.60	0.244	0.259
L9	3.50	3.93	0.137	0.154
M	2.6 typ.		0.102 typ.	
Diam	3.75	3.85	0.147	0.151

3 Ordering information

Table 8: Ordering information

Order code	Marking	Package	Weight	Base qty	Delivery mode
STTH803D	STTH803D	TO-220AC	1.86g	50	Tube
STTH803G-TR	STTH803G	D ² PAK	1.38g	1000	Tape and reel

4 Revision history

Table 9: Document revision history

Date	Revision	Changes
26-Jun-2012	9	
22-Apr-2015	10	Updated features, Table 1: "Device summary" in cover page. Minor text changes in Section 1: "Characteristics" . Updated Section 2: "Package information" .

IMPORTANT NOTICE – PLEASE READ CAREFULLY

STMicroelectronics NV and its subsidiaries ("ST") reserve the right to make changes, corrections, enhancements, modifications, and improvements to ST products and/or to this document at any time without notice. Purchasers should obtain the latest relevant information on ST products before placing orders. ST products are sold pursuant to ST's terms and conditions of sale in place at the time of order acknowledgement.

Purchasers are solely responsible for the choice, selection, and use of ST products and ST assumes no liability for application assistance or the design of Purchasers' products.

No license, express or implied, to any intellectual property right is granted by ST herein.

Resale of ST products with provisions different from the information set forth herein shall void any warranty granted by ST for such product.

ST and the ST logo are trademarks of ST. All other product or service names are the property of their respective owners.

Information in this document supersedes and replaces information previously supplied in any prior versions of this document.

© 2015 STMicroelectronics – All rights reserved



Компания «ЭлектроПласт» предлагает заключение долгосрочных отношений при поставках импортных электронных компонентов на взаимовыгодных условиях!

Наши преимущества:

- Оперативные поставки широкого спектра электронных компонентов отечественного и импортного производства напрямую от производителей и с крупнейших мировых складов;
- Поставка более 17-ти миллионов наименований электронных компонентов;
- Поставка сложных, дефицитных, либо снятых с производства позиций;
- Оперативные сроки поставки под заказ (от 5 рабочих дней);
- Экспресс доставка в любую точку России;
- Техническая поддержка проекта, помощь в подборе аналогов, поставка прототипов;
- Система менеджмента качества сертифицирована по Международному стандарту ISO 9001;
- Лицензия ФСБ на осуществление работ с использованием сведений, составляющих государственную тайну;
- Поставка специализированных компонентов (Xilinx, Altera, Analog Devices, Intersil, Interpoint, Microsemi, Aeroflex, Peregrine, Syfer, Eurofarad, Texas Instrument, Miteq, Cobham, E2V, MA-COM, Hittite, Mini-Circuits, General Dynamics и др.);

Помимо этого, одним из направлений компании «ЭлектроПласт» является направление «Источники питания». Мы предлагаем Вам помощь Конструкторского отдела:

- Подбор оптимального решения, техническое обоснование при выборе компонента;
- Подбор аналогов;
- Консультации по применению компонента;
- Поставка образцов и прототипов;
- Техническая поддержка проекта;
- Защита от снятия компонента с производства.

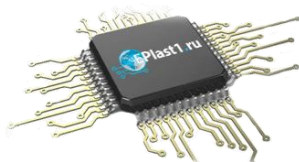

Как с нами связаться

Телефон: 8 (812) 309 58 32 (многоканальный)

Факс: 8 (812) 320-02-42

Электронная почта: org@eplast1.ru

Адрес: 198099, г. Санкт-Петербург, ул. Калинина, дом 2, корпус 4, литера А.