

EMI Suppression Filters (Lead Type EMIFIL[®])



⚠Note • Please read rating and ⚠CAUTION (for storage, operating, rating, soldering, mounting and handling) in this catalog to prevent smoking and/or burning, etc.
• This catalog has only typical specifications. Therefore, please approve our product specifications or transact the approval sheet for product specifications before ordering.

EU RoHS Compliant

- All the products in this catalog comply with EU RoHS.
- EU RoHS is "the European Directive 2011/65/EU on the Restriction of the Use of Certain Hazardous Substances in Electrical and Electronic Equipment."
- For more details, please refer to our website 'Murata's Approach for EU RoHS' (<http://www.murata.com/info/rohs.html>).

Contents

Product specifications are as of May 2014.

EMIFIL®, EMIGUARD®,
 "EMIFIL" and "EMIGUARD" in this catalog are
 the trademarks of Murata Manufacturing Co., Ltd.

| | |
|---|-----|
| Product Guide / Effective Frequency Range | p2 |
| Outline of EMI Suppression Filters (EMIFIL®) for DC Line | p3 |
| <hr/> | |
| Ferrite Beads Inductors | |
| Part Numbering | p7 |
| BL01/02/03 Series | p8 |
| <hr/> | |
| Disc Type EMIFIL® | |
| Part Numbering | p11 |
| DSS1 Series | p12 |
| DSN6/DSS6 Series | p14 |
| Broad Band Type DSN9/DST9 Series | p17 |
| Heavy-duty Type DSN9H/DST9H Series | p19 |
| <hr/> | |
| EMIGUARD® (EMIFIL® with Varistor Function) | |
| Part Numbering | p21 |
| VFC2H/VFR3V/VFS6V/VFS9V Series | p22 |
| ■ Noise Suppression Effect of VFR/VFS Series | p26 |
| <hr/> | |
| Common Mode Choke Coils | |
| Part Numbering | p30 |
| PLT09H Series | p31 |
| <hr/> | |
| ⚠Caution / Notice | p32 |
| Soldering and Mounting | p33 |
| ■ Packaging | p35 |

Please check the MURATA home page (<http://www.murata.com/>)
 if you cannot find the part number in the catalog.

Product Guide/Effective Frequency Range

| Type | Series | Effective Frequency Range | | | | | | |
|---|--|---------------------------|--------|------|-------|--------|------|-------|
| | | 10kHz | 100kHz | 1MHz | 10MHz | 100MHz | 1GHz | 10GHz |
| Disc Type EMIFIL® Ferrite Bead Inductor  | BL01/02/03 DSN6/9(H) DSS1 DSS6 DST9(H) | | | | | | | |
| EMIGUARD® (EMI Filters with varistor functions)  | VFC2H VFR3V VFS6V/9V | | | | | | | |
| Common Mode Choke Coils  | PLT09H | | | | | | | |

Outline of EMI Suppression Filters (EMIFIL[®]) for DC Line

● Ferrite Bead Inductor



■ Outline

- Chip Ferrite Beads are effective for frequencies ranging from a few MHz to a few GHz. Chip Ferrite Beads are widely used as a low noise countermeasure, as well as a universal noise suppression component.
- Chip Ferrite Beads produce a micro inductance in a low frequency range. At high frequencies, however, the resistive component of the inductor produces the primary impedance. When inserted in series in the noise producing circuit, the resistive impedance of the inductor prevents noise propagation.



Outline of EMI Suppression Filters (EMIFIL[®]) for DC Line

● Disc Type EMIFIL[®]

Disc Type EMIFIL[®]p.12–20



DSS1



DS□6



DS□9



DS□9H



■ Outline

- This capacitor type EMI suppression filter has a large noise suppression effect at frequencies ranging from a few MHz to hundreds of MHz. This type of filter is used widely as a universal, high performance EMI suppression component.
- Three-terminal construction reduces residual inductance, thereby substantially improving noise suppression at frequencies over 10MHz.

Comparison of Insertion Loss Characteristics



A three-terminal capacitor has a higher self resonance frequency than a general two-terminal type and exhibits effective noise suppression at high frequency.

Outline of EMI Suppression Filters (EMIFIL[®]) for DC Line

● EMIGUARD[®]



■ Outline

- EMIGUARD[®] eliminates both surge noise and EMI noise applying some unique design like the use of dielectric varistor material to a 3 terminal capacitor.
- Effective when high frequency noise and high voltage surge suppression are required, and also in situations when surging starts at extremely high speeds. This type of surging cannot be eliminated with general type varistors.

Construction of EMIGUARD[®] (VFS9V)



■ Surge Absorption Effect of EMIGUARD[®]

| Type of Filter | Surge Absorption Effect of EMIGUARD [®] |
|--|--|
| No filter | <p>4kV 500V/div -1kV -100ns 50ns/div 400ns</p> |
| Three-terminal capacitor is used to suppress the surge. | <p>4kV 500V/div -1kV -100ns 50ns/div 400ns</p> |
| EMIGUARD [®] is used to suppress the surge. (VFS6V) | <p>4kV 500V/div -1kV -100ns 50ns/div 400ns</p> |

Outline of EMI Suppression Filters (EMIFIL[®]) for DC Line

● Common Mode Choke Coil

Common Mode Choke Coilp.31



PLT09H

■ Outline

- These choke coils reduce common mode noise, which causes problems on balanced transmission lines, and are effective against common mode noise in the several MHz to several 100MHz frequency range. They are ideally suited for noise suppression on DC power supply lines and interface cables.

Construction of Common Mode Choke Coil



Equivalent Circuit



EMI Suppression Filters (Lead Type EMIFIL®)

Ferrite Beads Inductors Part Numbering

Ferrite Beads Inductors

(Part Number)



① Product ID

| Product ID | |
|------------|-------------------------|
| BL | Ferrite Beads Inductors |

② Series

| Code | Series |
|------|-----------------|
| 01 | Beads ø3.6 |
| 02 | Beads ø3.4 |
| 03 | Beads ø2.3 max. |

③ Beads Core Material

| Code | Beads Core Material |
|------|---------------------|
| RN | Standard Type |

④ Numbers of Beads Core

| Code | Numbers of Beads Core |
|------|-----------------------|
| 1 | 1 |
| 2 | 2 |

⑤ Lead Type

| Code | Lead Type | Series |
|------|--|-----------|
| A1 | Axial Straight Type | BL01 |
| A2 | Axial Crimp Type | BL01 |
| R1 | Radial Straight Type | BL02/BL03 |
| R2 | Radial Straight and Wave Formed Leads Type | BL02 |
| R3 | Radial Incrimp Type | BL02 |

⑥ Lead Length, Space

| Code | Lead Length, Space | Series |
|------|-----------------------------|-----------|
| A | Bulk, Axial Type, 3.7mm | BL01 |
| D | Bulk, Axial Type, 45.0mm | |
| E | Taping, Axial Type, 26.0mm | |
| F | Taping, Axial Type, 52.0mm | |
| J | Bulk, Radial Type, 5.0mm | BL02/BL03 |
| M | Bulk, Radial Type, 10.0mm | |
| N | Taping, Radial Type, 16.5mm | |
| P | Taping, Radial Type, 18.5mm | |
| Q | Taping, Radial Type, 20.0mm | |

⑦ Lead Diameter

| Code | Lead Diameter |
|------|---------------|
| 1 | ø0.60mm |
| 2 | ø0.65mm |

⑧ Packaging

| Code | Packaging | Series |
|------|---------------------|----------------|
| A | Ammo Pack | BL01/BL02/BL03 |
| B | Bulk | All Series |
| J | Paper Reel (ø320mm) | BL01 |

EMI Suppression Filters (Lead Type EMIFIL®)

Ferrite Beads Inductors BL01/02/03 Series

■ Features

BL01/02/03 series are ferrite beads with lead wires to produce a high frequency loss for suppression of noise. Simple construction and easy-to-use, effective for low impedance circuits such as power supplies and grounds. Effective also for preventing overshoot and undershoot of digital signal in clocks or the like, and suppressing the higher harmonic wave. Suitable for prevention of abnormal oscillation at high frequency amplifying circuit.



BL01RN1A1D2B

*Coating extending on leads : 1.5 max.

(in mm)



BL01RN1A2A2B



*Coating extending on leads : 1.5 max. (in mm)



BL02RN1R2M2B



*There is excess bond stick on the wire. (in mm)

(in mm)



BL02RN1R3J2B



*There is excess bond stick on the wire. (in mm)



BL02RN2R1M2B



(in mm)



BL02RN2R3J2B



(in mm)



BL03RN2R1M1B



(in mm)

BL01/BL02/BL03 Series

| Part Number | Rated Current (A) | Operating Temperature Range |
|--------------|-------------------|-----------------------------|
| BL01RN1A1D2B | 7 | -40 to +85°C |
| BL01RN1A1E1A | 6 | -40 to +85°C |
| BL01RN1A1F1J | 6 | -40 to +85°C |
| BL01RN1A2A2B | 7 | -40 to +85°C |
| BL02RN1R2M2B | 7 | -40 to +85°C |
| BL02RN1R2N1A | 6 | -40 to +85°C |
| BL02RN1R2P1A | 6 | -40 to +85°C |
| BL02RN1R2Q1A | 6 | -40 to +85°C |
| BL02RN1R3J2B | 7 | -40 to +85°C |
| BL02RN1R3N1A | 6 | -40 to +85°C |
| BL02RN2R1M2B | 7 | -40 to +85°C |
| BL02RN2R1N1A | 6 | -40 to +85°C |
| BL02RN2R1P1A | 6 | -40 to +85°C |
| BL02RN2R1Q1A | 6 | -40 to +85°C |
| BL02RN2R3J2B | 7 | -40 to +85°C |
| BL02RN2R3N1A | 6 | -40 to +85°C |
| BL03RN2R1M1B | 6 | -40 to +85°C |
| BL03RN2R1N1A | 6 | -40 to +85°C |
| BL03RN2R1P1A | 6 | -40 to +85°C |
| BL03RN2R1Q1A | 6 | -40 to +85°C |

Please refer to p.35, "Packaging" for Dimensions of Part Numbers Except for 'B' for the last code.

■ Equivalent Circuit



■ Impedance - Frequency Characteristics



Continued on the following page.

⚠Note • Please read rating and ⚠CAUTION (for storage, operating, rating, soldering, mounting and handling) in this catalog to prevent smoking and/or burning, etc.
 • This catalog has only typical specifications. Therefore, please approve our product specifications or transact the approval sheet for product specifications before ordering.

↳ Continued from the preceding page.

■ Impedance - Frequency Characteristics



Ferrite Beads Inductors

Disc Type EMIFIL®

EMIGUARD®
(EMIFIL® with Varistor Function)

Common Mode Choke Coils

⚠Caution / Notice

Soldering and Mounting

Packaging

EMI Suppression Filters (Lead Type EMIFIL®)

Disc Type EMIFIL® Part Numbering

Disc Type EMIFIL®

(Part Number)

| | | | | | | | | |
|----|---|---|---|----|----|-----|-----|---|
| DS | N | 9 | H | B3 | 2E | 101 | Q92 | A |
| ① | ② | ③ | ④ | ⑤ | ⑥ | ⑦ | ⑧ | ⑨ |

① Product ID

| Product ID | |
|------------|--------------------------|
| DS | Three-terminal Capacitor |

② Structure

| Code | Structure |
|------|-----------------------------|
| N | No Ferrite Beads Type |
| S | Built-in Ferrite Beads Type |
| T | with Ferrite Beads Type |

③ Style

| Code | Style |
|------|------------------------|
| 1 | Expressed by a letter. |
| 6 | |
| 9 | |

④ Category

| Code | Category |
|------|-----------------|
| N | for General Use |
| H | for Heavy-duty |

⑧ Lead Type/⑨ Packaging

| Code | Lead Type | Lead Length* (mm) | Packaging | Series |
|------|-----------|-------------------|---------------------|-----------------------|
| Q55B | Straight | 25.0 min. | Bulk | All series |
| Q50B | | 4.0±0.5 | | DST9N/H |
| Q52B | | 6.0±1.0 | | DST9N |
| Q54B | | 4.0±0.5 | | DSN6N/9N, DSS6N |
| Q56B | | 6.0±1.0 | | DSS6N |
| T41B | Incrimp | 4.0±0.5 | Paper Reel (ø320mm) | DSS1N |
| T51B | | 25.0 min. | | DS□6N, DSN9N/H, DSS1N |
| Q91A | Straight | 20.0±1.0 | Ammo Pack | DS□6N, DS□9N/H |
| Q92A | | 16.5±1.0 | | DSS6N |
| Q93A | | 18.5±1.0 | | |
| U21A | Incrimp | 16.5±1.0 | | |
| U31A | | 18.5±1.0 | | |

*Lead Distance between Reference and Bottom Planes Except for Bulk.

⑤ Temperature Characteristics

| Code | Capacitance Change |
|------|--|
| B3 | ±10% (Temperature Range: -25°C to +85°C) |
| C5 | ±22% (Temperature Range: -25°C to +85°C) |
| D3 | +20/-30% (Temperature Range: -25°C to +85°C) |
| E5 | +22/-56% (Temperature Range: -25°C to +85°C) |
| Z8 | +30/-85% (Temperature Range: -10°C to +60°C) |

⑥ Rated Voltage

| Code | Rated Voltage |
|------|---------------|
| 1H | 50V |
| 2A | 100V |
| 2E | 250V |

⑦ Capacitance

Expressed by three alphanumeric. The unit is in pico-farad (pF). The first and second figures are significant digits, and the third figure expresses the number of zeros that follow the two figures.

EMI Suppression Filters (Lead Type EMIFIL®)

Disc Type EMIFIL® DSS1 Series

■ Features

DSS1 series is a compact, high performance lead type 3 terminal capacitor which can be mounted in 2.54mm pitch.

Its three terminal structure enables nice high frequency performance.

Wide capacitance variation enables flexible selection for various noise frequencies.

High speed mounting is available with automatic insertion machine.



Built-in Ferrite Beads DSS1 Series

| Part Number | Capacitance (pF) | Rated Voltage (Vdc) | Rated Current (A) | Operating Temperature Range |
|--------------|------------------|---------------------|-------------------|-----------------------------|
| DSS1NB32A220 | 22 ±10% | 100 | 6 | -40 to +85°C |
| DSS1NB32A330 | 33 ±10% | 100 | 6 | -40 to +85°C |
| DSS1NB32A470 | 47 ±10% | 100 | 6 | -40 to +85°C |
| DSS1NB32A680 | 68 ±10% | 100 | 6 | -40 to +85°C |
| DSS1NB32A101 | 100 ±10% | 100 | 6 | -40 to +85°C |
| DSS1NB32A121 | 120 ±10% | 100 | 6 | -40 to +85°C |
| DSS1NB32A151 | 150 ±10% | 100 | 6 | -40 to +85°C |
| DSS1NB32A221 | 220 ±10% | 100 | 6 | -40 to +85°C |
| DSS1NB32A271 | 270 ±10% | 100 | 6 | -40 to +85°C |
| DSS1NB32A331 | 330 ±10% | 100 | 6 | -40 to +85°C |
| DSS1NB32A471 | 470 ±10% | 100 | 6 | -40 to +85°C |
| DSS1NB32A681 | 680 ±10% | 100 | 6 | -40 to +85°C |
| DSS1NB32A102 | 1000 ±10% | 100 | 6 | -40 to +85°C |
| DSS1NB32A152 | 1500 ±10% | 100 | 6 | -40 to +85°C |
| DSS1NB32A222 | 2200 ±10% | 100 | 6 | -40 to +85°C |
| DSS1NB32A332 | 3300 ±10% | 100 | 6 | -40 to +85°C |
| DSS1NB32A472 | 4700 ±10% | 100 | 6 | -40 to +85°C |
| DSS1NB32A682 | 6800 ±10% | 100 | 6 | -40 to +85°C |
| DSS1NB32A103 | 10000 ±10% | 100 | 6 | -40 to +85°C |
| DSS1NB32A153 | 15000 ±10% | 100 | 6 | -40 to +85°C |
| DSS1NB32A223 | 22000 ±10% | 100 | 6 | -40 to +85°C |
| DSS1NB31H333 | 33000 ±10% | 50 | 6 | -40 to +85°C |
| DSS1NB31H473 | 47000 ±10% | 50 | 6 | -40 to +85°C |
| DSS1NB31H104 | 100000 ±10% | 50 | 6 | -40 to +85°C |

Please refer to Part Numbering for Type and Length of Lead.

⚠Note • Please read rating and ⚠CAUTION (for storage, operating, rating, soldering, mounting and handling) in this catalog to prevent smoking and/or burning, etc.
 • This catalog has only typical specifications. Therefore, please approve our product specifications or transact the approval sheet for product specifications before ordering.

■ Equivalent Circuit



■ Insertion Loss Characteristics



Ferrite Beads Inductors

Disc Type EMIFIL®

EMIGUARD®
(EMIFIL® with Varistor Function)

Common Mode Choke Coils

⚠Caution / Notice

Soldering and Mounting

Packaging

EMI Suppression Filters (Lead Type EMIFIL®)

Disc Type EMIFIL® DSN6/DSS6 Series

■ Features

DS_6 is a compact, high performance lead type EMI suppression filter which can be mounted 2.54mm pitch. Its three terminal structure enables precise high frequency performance.



DSN6 Series

| Part Number | Capacitance (pF) | Rated Voltage (Vdc) | Rated Current (A) | Operating Temperature Range |
|--------------|------------------|---------------------|-------------------|-----------------------------|
| DSN6NC51H220 | 22 ±20% | 50 | 6 | -25 to +85°C |
| DSN6NC51H330 | 33 ±20% | 50 | 6 | -25 to +85°C |
| DSN6NC51H470 | 47 ±20% | 50 | 6 | -25 to +85°C |
| DSN6NC51H101 | 100 ±20% | 50 | 6 | -25 to +85°C |
| DSN6NC51H271 | 270 ±20% | 50 | 6 | -25 to +85°C |
| DSN6NC51H102 | 1000 ±20% | 50 | 6 | -25 to +85°C |
| DSN6NC51H222 | 2200 ±20% | 50 | 6 | -25 to +85°C |
| DSN6NZ81H103 | 10000 80/-20% | 50 | 6 | -25 to +85°C |

Please refer to Part Numbering for Type and Length of Lead.

■ Equivalent Circuit



■ Insertion Loss Characteristics



Built-in Ferrite Beads DSS6 Series Straight Type

| Part Number | Capacitance (pF) | Rated Voltage (Vdc) | Rated Current (A) | Operating Temperature Range |
|--------------|------------------|---------------------|-------------------|-----------------------------|
| DSS6NC52A220 | 22 ±20% | 100 | 6 | -25 to +85°C |
| DSS6NC52A330 | 33 ±20% | 100 | 6 | -25 to +85°C |
| DSS6NC52A470 | 47 ±20% | 100 | 6 | -25 to +85°C |
| DSS6NC52A101 | 100 ±20% | 100 | 6 | -25 to +85°C |
| DSS6NC52A151 | 150 ±20% | 100 | 6 | -25 to +85°C |
| DSS6NC52A221 | 220 ±20% | 100 | 6 | -25 to +85°C |
| DSS6NC52A271 | 270 ±20% | 100 | 6 | -25 to +85°C |
| DSS6NC52A471 | 470 ±20% | 100 | 6 | -25 to +85°C |
| DSS6NC52A102 | 1000 ±20% | 100 | 6 | -25 to +85°C |
| DSS6NE52A222 | 2200 80/-20% | 100 | 6 | -25 to +85°C |
| DSS6NZ82A103 | 10000 ±30% | 100 | 6 | -25 to +85°C |

Please refer to Part Numbering for Type and Length of Lead.

■ Equivalent Circuit



■ Insertion Loss Characteristics

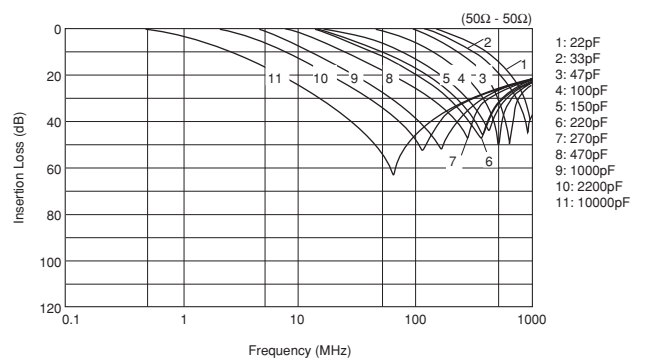

Built-in Ferrite Beads DSS6 Series Incrimp Type

| Part Number | Capacitance (pF) | Rated Voltage (Vdc) | Rated Current (A) | Operating Temperature Range |
|--------------|------------------|---------------------|-------------------|-----------------------------|
| DSS6NC52A220 | 22 ±20% | 100 | 6 | -25 to +85°C |
| DSS6NC52A330 | 33 ±20% | 100 | 6 | -25 to +85°C |
| DSS6NC52A470 | 47 ±20% | 100 | 6 | -25 to +85°C |
| DSS6NC52A101 | 100 ±20% | 100 | 6 | -25 to +85°C |
| DSS6NC52A151 | 150 ±20% | 100 | 6 | -25 to +85°C |
| DSS6NC52A221 | 220 ±20% | 100 | 6 | -25 to +85°C |
| DSS6NC52A271 | 270 ±20% | 100 | 6 | -25 to +85°C |
| DSS6NC52A471 | 470 ±20% | 100 | 6 | -25 to +85°C |
| DSS6NC52A102 | 1000 ±20% | 100 | 6 | -25 to +85°C |
| DSS6NE52A222 | 2200 80/-20% | 100 | 6 | -25 to +85°C |
| DSS6NZ82A103 | 10000 ±30% | 100 | 6 | -25 to +85°C |

Please refer to Part Numbering for Type and Length of Lead.

■ Equivalent Circuit



■ Insertion Loss Characteristics



EMI Suppression Filters (Lead Type EMIFIL®)

Disc Type EMIFIL® Broad Band Type DSN9/DST9 Series

■ Features

DS_9 is a basic type EMI suppression filter which can obtain high insertion loss in a wide frequency range. Its three terminal structure enables precise high frequency performance.

■ Supplement

Diameter of lead is 0.6mm for taping type.
 Taping type is three terminal in-line arrangement.



DSN9 Series

| Part Number | Capacitance (pF) | Rated Voltage (Vdc) | Rated Current (A) | Operating Temperature Range |
|--------------|------------------|---------------------|-------------------|-----------------------------|
| DSN9NC52A271 | 270 ±20% | 100 | 7 | -25 to +85°C |
| DSN9NC52A222 | 2200 ±20% | 100 | 7 | -25 to +85°C |
| DSN9NC51H223 | 22000 50/-20% | 50 | 7 | -25 to +85°C |

Rated current is 6A for taping type and its lead diameter is phi 0.6mm.
 Please refer to Part Numbering for Type and Length of Lead.

■ Equivalent Circuit



■ Insertion Loss Characteristics



With Ferrite Beads DST9 Series

| Part Number | Capacitance (pF) | Rated Voltage (Vdc) | Rated Current (A) | Operating Temperature Range |
|--------------|------------------|---------------------|-------------------|-----------------------------|
| DST9NB32A271 | 270 ±20% | 100 | 7 | -25 to +85°C |
| DST9NC52A271 | 270 ±20% | 100 | 7 | -25 to +85°C |
| DST9NB32A222 | 2200 ±20% | 100 | 7 | -25 to +85°C |
| DST9NC52A222 | 2200 ±20% | 100 | 7 | -25 to +85°C |
| DST9NC51H223 | 22000 50/-20% | 50 | 7 | -25 to +85°C |
| DST9ND31H223 | 22000 50/-20% | 50 | 7 | -25 to +85°C |

Rated current is 6A for taping type and its lead diameter is phi 0.6mm.
 Please refer to Part Numbering for Type and Length of Lead.

■ Equivalent Circuit



■ Insertion Loss Characteristics



EMI Suppression Filters (Lead Type EMIFIL®)

Disc Type EMIFIL® Heavy-duty Type DSN9H/DST9H Series

■ Features

DS_9H is a basic type EMI suppression filter which can obtain high insertion loss in a wide frequency range. Its three terminal structure enables nice high frequency performance. High rated voltage of 250Vdc and wide operating temperature range from -40 degrees C to 105 degrees C are suitable for high reliability circuits.

■ Supplement

Diameter of lead is 0.6mm for tapping type.
 Taping type is three terminal in-line arrangement.



DSN9H Series

| Part Number | Capacitance (pF) | Rated Voltage (Vdc) | Rated Current (A) | Operating Temperature Range |
|--------------|------------------|---------------------|-------------------|-----------------------------|
| DSN9HB32E220 | 22 ±20% | 250 | 6 | -40 to +105°C |
| DSN9HB32E101 | 100 ±20% | 250 | 6 | -40 to +105°C |
| DSN9HB32E271 | 270 ±20% | 250 | 6 | -40 to +105°C |
| DSN9HB32E222 | 2200 ±20% | 250 | 6 | -40 to +105°C |

Please refer to Part Numbering for Type and Length of Lead.

■ Equivalent Circuit



■ Insertion Loss Characteristics



With Ferrite Beads DST9H Series

| Part Number | Capacitance (pF) | Rated Voltage (Vdc) | Rated Current (A) | Operating Temperature Range |
|--------------|------------------|---------------------|-------------------|-----------------------------|
| DST9HB32E220 | 22 ±20% | 250 | 6 | -40 to +105°C |
| DST9HB32E101 | 100 ±20% | 250 | 6 | -40 to +105°C |
| DST9HB32E271 | 270 ±20% | 250 | 6 | -40 to +105°C |
| DST9HB32E222 | 2200 ±20% | 250 | 6 | -40 to +105°C |

Please refer to Part Numbering for Type and Length of Lead.

Equivalent Circuit



Insertion Loss Characteristics



EMI Suppression Filters (Lead Type EMIFIL®)

EMIGUARD® (EMIFIL® with Varistor Function) Part Numbering

EMIGUARD® (EMIFIL® with Varistor Function)

(Part Number)



① Product ID

| Product ID | |
|------------|---------------------|
| VF | EMIGUARD® Lead Type |

② Structure

| Code | Structure |
|------|-----------------------------|
| S | Built-in Ferrite Beads Type |
| R | with Resistance |
| C | Built-in Capacitor |

③ Style

| Code | Style |
|------|------------------------------|
| 2 | Size is expressed by a digit |
| 3 | |
| 6 | |
| 9 | |

④ Features

| Code | Features |
|------|---|
| V | with Varistor Function |
| H | with Varistor Function (for Automotive) |

⑤ Temperature Characteristics

| Code | Capacitance Change |
|------|---|
| D8 | +20/-30% (Temperature Range: -40°C to +105°C) |
| D3 | +20/-30% (Temperature Range: -25°C to +85°C) |
| R7 | ±15% (Temperature Range: -55°C to +125°C) |

⑥ Rated Voltage

| Code | Rated Voltage |
|------|---------------|
| 1B | 12V |
| 1D | 22V |
| 1E | 25V |

⑦ Capacitance

Expressed by three alphanumeric. The unit is in pico-farad (pF). The first and second figures are significant digits, and the third figure expresses the number of zeros that follow the two figures.

⑧ Capacitance

| Code | Capacitance |
|------|-------------|
| K | ±10% |

⑨ Varistor Voltage

| Code | Varistor Voltage |
|------|------------------|
| 2 | 27V |

⑩ Lead Type/⑪ Packaging

| Code | Lead Type | Lead Length* | Packaging | Series |
|------|-----------|--------------|---------------------|-----------|
| T51B | Incrimp | 25.0mm min. | Bulk | VFR3/VFS6 |
| U31A | | 18.5±1.0mm | Ammo Pack | |
| Q55B | Straight | 25.0mm min. | Bulk | VFS9 |
| Q91J | | 20.0±1.0mm | Paper Reel (ø320mm) | |
| Q92J | | 16.5±1.0mm | | |
| Q93J | | 18.5±1.0mm | | |

*Lead Distance between Reference and Bottom Planes Except for Bulk.

| Code | Lead Type | Lead Length* | Packaging | Series |
|------|--------------|--------------|---------------------|--------|
| K1B | Inside Crimp | 26.0±1.0mm | Bulk | VFC2 |
| M1A | | 18.0±1.0mm | Ammo Pack | |
| M1J | | | Paper Reel (ø320mm) | |

*From bottom of the crimp.

EMI Suppression Filters (Lead Type EMIFIL®)

EMIGUARD® (EMIFIL® with Varistor Function) VFC2H/VFR3V/VFS6V/VFS9V Series

VFC2H Series

VFC2H series is EMI suppression filters of lead type that combines the varistor and capacitor.

■ Features

1. Suitable for absorbing surge voltages occurred from inductive load of motors, relays, etc.
2. High maximum energy
3. Smaller size, High capacitance
4. Taping is capable of fast implementation of automatic insertion.



| Part Number | Varistor Voltage (Vdc) | Capacitance (μF) | Temperature Characteristics | Rated Voltage (Vdc) | Rated Current | Insulation Resistance (min.) (M ohm) | Operating Temperature Range |
|----------------|------------------------|------------------|-----------------------------|---------------------|---------------|--------------------------------------|-----------------------------|
| VFC2HR71D105K2 | 27 +5/-3V | 1.0 ±10% | R7 (±15%) | 22 | - | 1 | -55 to 125°C |

Please refer to Part Numbering for Type and Length of Lead.

■ Equivalent Circuit



Semiconductor Protection VFR3V Series

■ Features

VFR3V series is designed for ESD surge protection of IC. It efficiently absorbs ESD surges rushed into IC's I/O terminal.

■ Applications

Elimination of noise and protection of semiconductors in office equipment, including computers and peripheral equipment, copy machines, and communication terminals.



| Part Number | Varistor Voltage (Vdc) | Capacitance (pF) | Rated Voltage (Vdc) | Rated Current (mA) | Peak Pulse Current (A) | Operating Temperature Range |
|--------------|------------------------|------------------|---------------------|--------------------|------------------------|-----------------------------|
| VFR3VD31E131 | 50 ±20% | 130 ±20% | 25 | 20 | 30 | -25 to 85°C |

Please refer to Part Numbering for Type and Length of Lead.

■ Insertion Loss Characteristics



Signal Line VFS6V Series

■ Features

VFS6V series is designed for surge protection of signal line. It protects electric circuit from surges such as static electricity and suppresses EMI noise. Built-in ferrite bead gives excellent EMI suppression.

■ Applications

Elimination of noise and protection of electric circuits in office equipment, including computers and peripheral equipment, copy machines, and communication terminals.



| Part Number | Varistor Voltage (Vdc) | Capacitance (pF) | Rated Voltage (Vdc) | Rated Current (A) | Peak Pulse Current (A) | Operating Temperature Range |
|--------------|------------------------|------------------|---------------------|-------------------|------------------------|-----------------------------|
| VFS6VD81E221 | 50 ±20% | 220 ±20% | 25 | 6 | 100 | -40 to 105°C |

Please refer to Part Numbering for Type and Length of Lead.

■ Equivalent Circuit



■ Insertion Loss Characteristics



Large Current VFS9V Series

■ Features

VFS9V series is designed for surge protection of the power supply. It protects electric circuits from surge such as static electricity and suppresses EMI noise. Its large capacitance value enables high insertion loss for EMI noise.

■ Applications

For circuit protection and noise suppression in electronics equipment such as computers and DC motors, and in electronics systems installed in cars such as car audio equipment and engine controllers.



*1 Coating extending on leads does not exceed the tangent line. Exposed electrode, if any, is covered by solder, etc.
 *2 If there is a hole in the top of the filter, the ferrite bead should not be exposed.

| Part Number | Varistor Voltage (Vdc) | Capacitance (pF) | Rated Voltage (Vdc) | Rated Current (A) | Operating Temperature Range |
|--------------|------------------------|------------------|---------------------|-------------------|-----------------------------|
| VFS9VD31B223 | 22 ±20% | 22000 +50/-20% | 12 | 7 | -40 to 100°C |

Rated current is 7A for bulk type and 6A for taping type.

Rated current of taping type is 6A because the diameter of the lead is 0.6mm and its lead layout is the in-line type.

Please refer to Part Numbering for Type and Length of Lead.

■ Equivalent Circuit



■ Insertion Loss Characteristics



■ Voltage - Current Characteristics



Noise Suppression Effect of VFR/VFS Series

■ Example of IC Protection (VFR3V)

● Testing Method

1. Put ESD surge to IC (7404 family) input terminal with ESD simulator based on IEC 801-2.
2. Check IC's operation.
3. If IC's operation is normal, increase ESD voltage in 1kV steps.
4. Continue above steps 1 to 3 till IC's operation becomes abnormal.

● Result

Varistor VFR3V can protect IC from ESD.



■ Example of EMI Suppression Effect



| Type of Filter | EMI Suppression Effect |
|-------------------------------------|------------------------|
| Before Countermeasures (No Filters) | |
| Using VFR3VD31E131T51 | |

Noise Suppression Effect of VFR/VFS Series

■Features (VFS9V)

| Items | Test methods | Rated values | | | | | | | | | | |
|---|--|---|-------|----------------|--------------------------|-------------------|-----------------------|--------------------|---|-------------------|--------------|-----------|
| Overload | 1.4 times the varistor voltage (V_1) is applied for 5 minutes at room temperature. | <table border="1"> <thead> <tr> <th>Items</th> <th>Specifications</th> </tr> </thead> <tbody> <tr> <td>Rated Capacitance Change</td> <td>Within $\pm 15\%$</td> </tr> <tr> <td>Insulation Resistance</td> <td>500kΩ min.</td> </tr> <tr> <td>Rated of Change in Varistor Voltage V_1^*</td> <td>Within $\pm 15\%$</td> </tr> <tr> <td>Voltage Rate</td> <td>1.30 max.</td> </tr> </tbody> </table> <p>*V_1: Voltage when 1mA is applied</p> | Items | Specifications | Rated Capacitance Change | Within $\pm 15\%$ | Insulation Resistance | 500k Ω min. | Rated of Change in Varistor Voltage V_1^* | Within $\pm 15\%$ | Voltage Rate | 1.30 max. |
| Items | Specifications | | | | | | | | | | | |
| Rated Capacitance Change | Within $\pm 15\%$ | | | | | | | | | | | |
| Insulation Resistance | 500k Ω min. | | | | | | | | | | | |
| Rated of Change in Varistor Voltage V_1^* | Within $\pm 15\%$ | | | | | | | | | | | |
| Voltage Rate | 1.30 max. | | | | | | | | | | | |
| Surge Test (1) | At room temperature, Surges are applied 10^5 times every 2 seconds. Then after 1 or 2 hours, the sample is measured.  | | | | | | | | | | | |
| Surge Test (2) | At room temperature, the capacitor "C" is charged with 70V, then discharged to apply the voltage to the sample. Tested once (resuming JASO A-1).  | | | | | | | | | | | |
| High Temperature Load | At a temperature of $85 \pm 3^\circ\text{C}$, the varistor voltage V_1 is continuously applied to the sample for 1000 to 1024 hours. Then it is left at room temperature, for 4 to 24 hours before measuring. | | | | | | | | | | | |

■Pulse-Voltage Breakdown Characteristic (VFS9V)

VFS9V EMIGUARD[®] use a self healing varistor- capacitor, so that it can be used under a 500 to 600V surge that would break conventional disc type EMI filters. As shown in the figure below EMIGUARD[®] withstands 2000V impulses applied 1000 times.



■Temperature Characteristics of Varistor Voltage - Insulation Resistance (VFS9V)

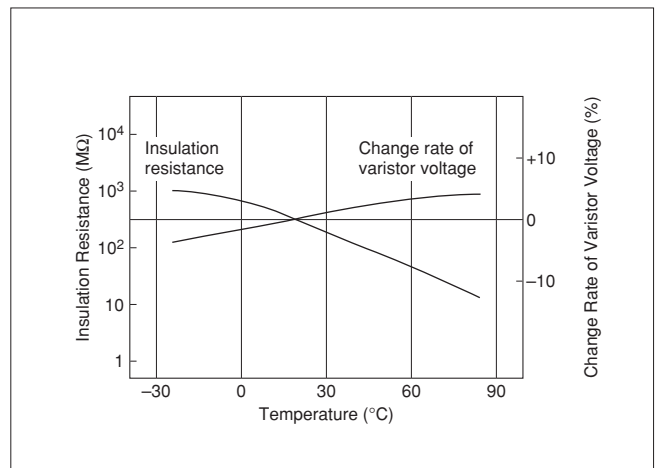

Continued on the following page. ↗

Noise Suppression Effect of VFR/VFS Series

Continued from the preceding page.

Noise Absorption Effect of EMIGUARD® (VFS9V)

| Type of Filter | EMI Suppression Effect | Description |
|--------------------|------------------------|--|
| without EMIGUARD® | | Waveform when EMIGUARD® is not used. (Surge from a noise simulator.) |
| with EMIGUARD® | | Waveform after the noise passed through EMIGUARD®. Little noise is recorded. |

Comparative Data (VFS9V)

1. Absorption of quick-rising, high-frequency noise (10ns/div, 100V/div)

| Type of Filter | EMI Suppression Effect | Description |
|---|------------------------|--|
| Without Filters | | |
| Conventional varistor | | As with the two-terminal capacitor |
| Two-terminal capacitor (with varistor function) | | The two-terminal capacitor is influenced by lead line inductance, leaving behind some of the rising and falling edges. The residual noise can cause the system to malfunction. |
| VFS9V | | The three-terminal structure eliminates most of the lead line inductance. This allows VFS9V to completely absorb the rising and falling edges of the applied pulses. |

Continued on the following page.

Noise Suppression Effect of VFR/VFS Series

☐ Continued from the preceding page.

2. Absorption of wide-pulse noise (50ns/div, 200V/div)

| Type of Filter | EMI Suppression Effect | Description |
|--|---|---|
| Without Filters |  <p style="text-align: center;">Noise wave applied</p> | |
| Two-terminal capacitor |  | In capacitors the voltage of the residual surge (1300V) is higher than that of the above example. The wave height is almost the same as the original. |
| Three-terminal capacitor (with ferrite bead) |  | Conventional EMI filters do not work for wide-pulse noise because the capacitors are saturated. In this example, the residual 1200V surge can cause the system to break down. |
| VFS9V |  | Bypassing the high voltage to the ground suppresses the voltage. |

Ferrite Beads Inductors

Disc Type EMIFIL®

EMIGUARD®
(EMIFIL® with Varistor Function)

Common Mode Choke Coils

⚠Caution / Notice

Soldering and Mounting

Packaging

EMI Suppression Filters (Lead Type EMIFIL®)

Common Mode Choke Coils Part Numbering

Common Mode Choke Coils

(Part Number)

| | | | | | | | | |
|----|---|-----|---|-----|-----|---|---|---|
| PL | T | 09H | N | 200 | 3R0 | P | 1 | B |
| ① | ② | ③ | ④ | ⑤ | ⑥ | ⑦ | ⑧ | ⑨ |

① Product ID

| Product ID | |
|------------|-------------------------|
| PL | Common Mode Choke Coils |

② Type

| Code | Type |
|------|---------|
| T | DC Type |

③ Applications

| Code | Applications |
|------|---------------------------------|
| 09H | for DC Line High-frequency Type |

④ Features

| Code | Features |
|------|-------------|
| N | General Use |

⑨ Packaging

| Code | Packaging | Series |
|------|-----------|------------|
| B | Bulk | All series |

⑤ Inductance

Expressed by three figures. The unit is micro-henry (μH). The first and second figures are significant digits, and the third figure expresses the number of zeros that follow the two figures.

⑥ Rated Current

Expressed by three-digit alphanumerics. The unit is in amperes (A). A decimal point is expressed by the capital letter "R". In this case, all figures are significant digits.

⑦ Winding Mode

| Code | Winding Mode |
|------|----------------------|
| P | Aligned Winding Type |

⑧ Lead Dimensions

| Code | Lead Dimensions |
|------|-----------------|
| 1 | 5mm |

EMI Suppression Filters (Lead Type EMIFIL®)

Common Mode Choke Coils (for DC Line) PLT09H Series

PLT09H series is a common mode choke coil for DC lines. It is effective against the common mode noise that can cause radiative noise in power supply lines and interface lines. The additional normal mode inductance enables high suppression effect to radiation noise.

■ Features

1. This is a wide frequency range type, applicable in applications ranging from a few MHz to several 100MHz.
2. It features a low-profile design.

■ Applications

1. Noise suppression of SW power supply, DC-DC converter
2. DC power lines in AC adapter of Portable equipment

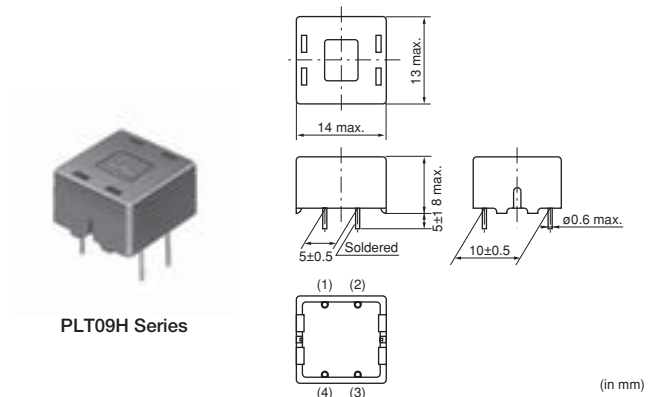

| Part Number | Rated Current (A) | Rated Voltage (Vdc) | Withstand Voltage (Vdc) | Common Mode Inductance (μH) |
|-----------------|-------------------|---------------------|-------------------------|-----------------------------|
| PLT09HN2003R0P1 | 3 | 50 | 125 | 20 min. |

Operating Temperature Range: -40 to +85°C

■ Equivalent Circuit



■ Insertion Loss Characteristics



⚠Caution/Notice

⚠Caution

● Rating

Do not use products beyond the rated current and rated voltage as this may create excessive heat and deteriorate the insulation resistance.

● Soldering and Mounting

1. Mounting holes should be designed as specified in these specifications. Other designs than those shown in these specifications may cause cracks in ceramics that may lead to smoking or firing.

2. DSN9/DST9/DSN9H/DST9H/VFS9V Series
Mounting for PCB. (Applis only to bulk type.)

The form of the mounting hole of the bulk item is a triangle.
 The product should be inserted and soldered to each hole in the correct way as in Fig.1. (The center terminal and the other terminals become parallel when viewing the product from the side.) Smoking and firing maybe caused by incorrect mounting as in Fig.2. (The center terminal and the other terminals cross when viewing the product from the side.)



3. Take care not to apply any mechanical stress to product body at the lead terminal bending process for product angle adjustment after insertion.
 For DST9, please do not bend the lead terminal at the point between the dielectric part and the ferrite bead.

Notice

● Storage and Operating Conditions

<Operating Environment>

1. Do not use products in a chemical atmosphere such as chlorine gas, acid or sulfide gas.
2. Do not use products near water, oil or organic solvents. Avoid environments where dust or dirt may adhere to the product.

<Storage and Handling Requirements>

1. Storage Period
Use the products within 12 months after delivery.
Solderability should be checked if this period is exceeded.
2. Storage Conditions
 - (1) Storage temperature: -10 to 40 degrees C
Relative humidity: 15 to 85%
Avoid sudden changes in temperature and humidity.
 - (2) Do not store products in a chemical atmosphere such as chlorine gas, acid or sulfide gas.
 - (3) When restoring taping type (BL01RN1A1F1J), please attach the spacer between the flanges of the reel. The spacer is corrugated paper that is attached when shipping.

<Using EMIGUARD® effectively>

1. Terminal (with mark) should be properly connected to the line of incoming electrostatic surge. (There is polarity.) Otherwise, no effect in ESD suppression can be expected (VFR3V).



2. Products should be used at rated voltage or less and rated current or less.
3. Products should not be applied for the absorption of surges that have large energy (e.g., induced lightning surges, switching surges) because it is designed for the absorption of electrostatic surges (VFR3V).
4. Electrostatic testing should be done on the following conditions (VFR3V).

$$n \cdot [C / R \cdot V^2]^2 < 8.0 \times 10^5$$
 - n: Times applied
 - C: Charging Capacitance (pF)
 - V: Testing Voltage (kV)
 - R: Charging Resistance (Ω)

● Soldering and Mounting

1. Washing
Failure and degradation of a product are caused by the washing method. When you wash in conditions that are not in the mounting information, please contact Murata engineering.
2. Soldering
Reliability decreases with improper soldering methods. Please solder by the standard soldering conditions shown in the mounting information.
3. Other
Noise suppression levels resulting from Murata's EMI suppression filters EMIFIL® may vary, depending on the circuits and ICs used, type of noise, mounting pattern, lead wire length, mounting location, and other operating conditions. Be sure to check and confirm in advance the noise suppression effect of each filter, in actual circuits, etc. before applying the filter in a commercial-purpose equipment design.

Soldering and Mounting

1. Mounting Hole

Mounting holes should be designed as specified below.

| Part Number | Bulk Type (in mm) | Taping Type (in mm) |
|--|-------------------|---------------------|
| DSN6 DSS6 VFR3V VFS6V DSS1 | | |
| DSN9 DSN9H | | |
| DST9 DST9H | | |
| VFS9V | | |
| VFC2H | | |

2. Soldering

- (1) Use Sn-3.0Ag-0.5Cu solder.
- (2) Use Rosin-based flux. Do not use strong acidic flux with halide content exceeding 0.2wt% (chlorine conversion value).
- (3) Products and the leads should not be subjected to any mechanical stress during the soldering process, or while subjected to the equivalent high temperatures.
- (4) Standard flow soldering profile.



Continued on the following page.

Soldering and Mounting

☐ Continued from the preceding page.

3. Cleaning Conditions

Do not clean VFR3V, PLT09H and VFS6V series.

Clean other parts in the following conditions.

- (1) Cleaning temperature should be limited to 60°C max.
(40°C max for alcohol type cleaner).
- (2) Ultrasonic cleaning should comply with the following conditions, avoiding the resonance phenomenon at the mounted products and PCB.
Power: 20 W / ℓ max. Frequency: 28 to 40kHz
Time: 5 min. max.
- (3) Cleaner
 - (a) Alcohol type cleaner
Isopropyl alcohol (IPA)
 - (b) Aqueous agent (PLT series cannot be cleaned)
PINE ALPHA ST-100S

- (4) There should be no residual flux or residual cleaner left after cleaning.
In the case of using aqueous agent, products should be dried completely after rinsing with de-ionized water in order to remove the cleaner.
- (5) The surface of products may become dirty after cleaning, but there is no deterioration on mechanical, electrical characteristics and reliability.
- (6) Other cleaning: Please contact us.

■ Minimum Quantity (Pcs.)

| Series | Bulk | Ammo Pack | ø320mm Paper Reel |
|--------|------|-----------|-------------------|
| BL01RN | 500 | 1000 | 2000 |
| BL02RN | 500 | 1500 | — |
| BL03RN | 1000 | 2000 | — |

■ Taping Dimensions

BL01RN_J
BL01RN_A



BL02RN1R2□1A

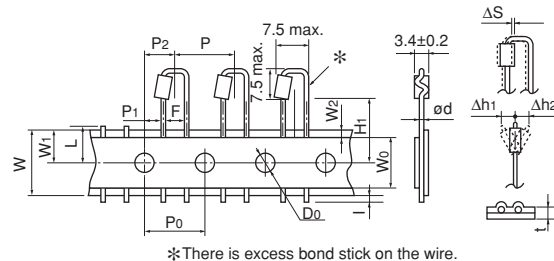

BL02RN1R3N1A

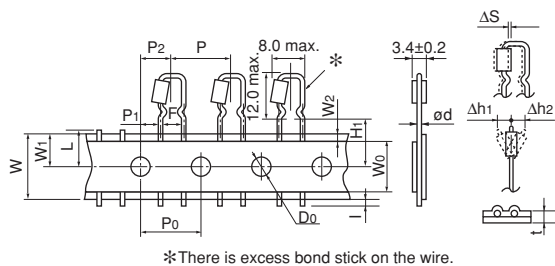

BL02RN2R1□1A

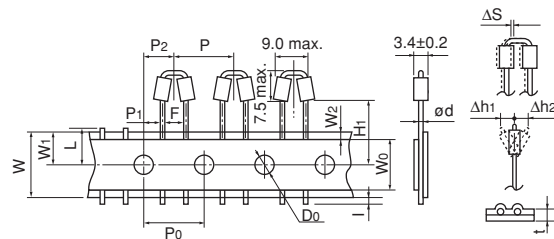

BL02RN2R3N1A

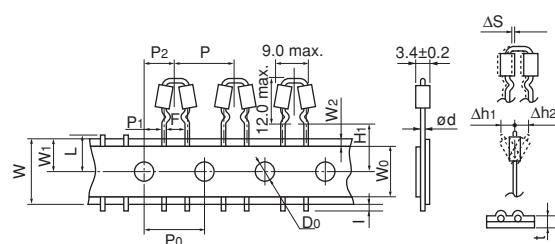

BL03RN2R1□1A

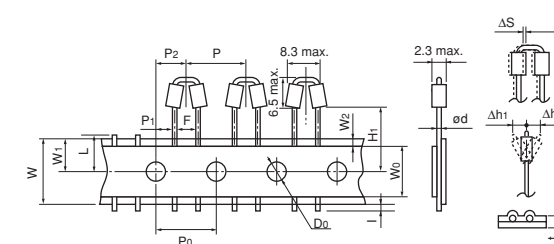

| Description | Symbol | Dimension (mm) | Remarks |
|--|----------|-------------------------------------|---|
| Pitch of component | P | 12.7 | Product inclination ΔS determines tolerance |
| Pitch of sprocket hole | P0 | 12.7±0.2 | |
| Lead spacing | F | 5.0 ^{+0.8} _{-0.2} | |
| Hole center to lead | P1 | 3.85±0.7 | |
| Hole center to component center | P2 | 6.35±1.3 | Tape deviation in feeding direction |
| Offset of bead | ΔS | ±1.0 | Including the offset caused by lead bend |
| Carrier tape width | W | 18.0±0.5 | |
| Position of sprocket hole | W1 | 9.0 ⁺⁰ _{-0.5} | Tape with deviation |
| Lead length between sprocket hole and forming position | H1 | Lead Length Number : N | 16.5±0.5 |
| | | Lead Length Number : Q | 20.0±0.5 |
| | | Lead Length Number : P | 18.5±0.5 |
| Protruding length | l | +0.5 to -1.0 | |
| Diameter of sprocket hole | D0 | ø4.0±0.1 | |
| Lead Diameter | ød | ø0.60 | |
| Total tape thickness | t | 0.7±0.2 | Including bonding tape thickness |
| Deviation across tape, Deviation across tape rear | Δh1, Δh2 | 1.0 max. | |
| Cutting position of failure | L | 11.0 ⁺⁰ _{-1.0} | |
| Hold down tape width | W0 | 12.0±0.5 | |
| Hold down tape position | W2 | 1.5±1.5 | |

(in mm)

Packaging

Minimum Quantity

| Part Number | Minimum Order Quantity (order in sets only) (pcs.) | | |
|-------------------|--|-------------------|--------------------------------|
| | Ammo Pack | ø320mm Paper Reel | Bulk (Bag) |
| VFR3V Series | 2000 | — | 250 |
| DS□6/VFS6V Series | 2000 | — | 250 Q55/T51 500 Q54/Q56/T41 |
| DSN9/9H Series | 2000 | — | 250 Q55 500 Q54/Q56 |
| DST9 Series | 1000 | — | 200 Q55 250 Q50/Q52 |
| VFS9V Series | — | 800 | 200 |
| VFC2H Series | 2000 | 2000 | 500 |
| DSS1 Series | 1500 | 1500 | 250 |

Lead Type Code

| Lead Type Code | | Lead Length (H) |
|----------------|--------------|-----------------|
| Straight Type | Incrimp Type | |
| Q91 | - | 20.0±1.0mm |
| Q92 | U21 | 16.5±1.0mm |
| Q93 | U31 | 18.5±1.0mm |

| Lead Type Code | Lead Length (from bottom of the crimp) |
|----------------|---|
| Inside Crimp | |
| K1B | 26.0±1.0mm |
| M1A | 18.0±1.0mm |
| M1J | |

Taping Dimensions

DSN6_Q91/Q92/Q93

DSN9_Q91/Q92/Q93



DSS1_Q91



DSS6_Q91/Q92/Q93



DST9_Q92/Q93



DSS6_U21/U31

VFS6V_U31



VFS9V_Q91/Q92/Q93



(in mm)

Continued on the following page. ↗

☐ Continued from the preceding page.

■ Taping Dimensions



Global Locations

For details please visit www.murata.com



⚠ Note

1 Export Control

For customers outside Japan:

No Murata products should be used or sold, through any channels, for use in the design, development, production, utilization, maintenance or operation of, or otherwise contribution to (1) any weapons (Weapons of Mass Destruction [nuclear, chemical or biological weapons or missiles] or conventional weapons) or (2) goods or systems specially designed or intended for military end-use or utilization by military end-users.

For customers in Japan:

For products which are controlled items subject to the "Foreign Exchange and Foreign Trade Law" of Japan, the export license specified by the law is required for export.

2 Please contact our sales representatives or product engineers before using the products in this catalog for the applications listed below, which require especially high reliability for the prevention of defects which might directly damage a third party's life, body or property, or when one of our products is intended for use in applications other than those specified in this catalog.

- ① Aircraft equipment
- ② Aerospace equipment
- ③ Undersea equipment
- ④ Power plant equipment
- ⑤ Medical equipment
- ⑥ Transportation equipment (vehicles, trains, ships, etc.)
- ⑦ Traffic signal equipment
- ⑧ Disaster prevention / crime prevention equipment
- ⑨ Data-processing equipment
- ⑩ Application of similar complexity and/or reliability requirements to the applications listed above

3 Product specifications in this catalog are as of May 2014. They are subject to change or our products in it may be discontinued without advance notice. Please check with our sales representatives or product engineers before ordering. If there are any questions, please contact our sales representatives or product engineers.

4 Please read rating and ⚠CAUTION (for storage, operating, rating, soldering, mounting and handling) in this catalog to prevent smoking and/or burning, etc.

5 This catalog has only typical specifications. Therefore, please approve our product specifications or transact the approval sheet for product specifications before ordering.

6 Please note that unless otherwise specified, we shall assume no responsibility whatsoever for any conflict or dispute that may occur in connection with the effect of our and/or a third party's intellectual property rights and other related rights in consideration of your use of our products and/or information described or contained in our catalogs. In this connection, no representation shall be made to the effect that any third parties are authorized to use the rights mentioned above under licenses without our consent.

7 No ozone depleting substances (ODS) under the Montreal Protocol are used in our manufacturing process.

Murata Manufacturing Co., Ltd.

www.murata.com

muRata
INNOVATOR IN ELECTRONICS



Компания «ЭлектроПласт» предлагает заключение долгосрочных отношений при поставках импортных электронных компонентов на взаимовыгодных условиях!

Наши преимущества:

- Оперативные поставки широкого спектра электронных компонентов отечественного и импортного производства напрямую от производителей и с крупнейших мировых складов;
- Поставка более 17-ти миллионов наименований электронных компонентов;
- Поставка сложных, дефицитных, либо снятых с производства позиций;
- Оперативные сроки поставки под заказ (от 5 рабочих дней);
- Экспресс доставка в любую точку России;
- Техническая поддержка проекта, помощь в подборе аналогов, поставка прототипов;
- Система менеджмента качества сертифицирована по Международному стандарту ISO 9001;
- Лицензия ФСБ на осуществление работ с использованием сведений, составляющих государственную тайну;
- Поставка специализированных компонентов (Xilinx, Altera, Analog Devices, Intersil, Interpoint, Microsemi, Aeroflex, Peregrine, Syfer, Eurofarad, Texas Instrument, Miteq, Cobham, E2V, MA-COM, Hittite, Mini-Circuits, General Dynamics и др.);

Помимо этого, одним из направлений компании «ЭлектроПласт» является направление «Источники питания». Мы предлагаем Вам помощь Конструкторского отдела:

- Подбор оптимального решения, техническое обоснование при выборе компонента;
- Подбор аналогов;
- Консультации по применению компонента;
- Поставка образцов и прототипов;
- Техническая поддержка проекта;
- Защита от снятия компонента с производства.



Как с нами связаться

Телефон: 8 (812) 309 58 32 (многоканальный)

Факс: 8 (812) 320-02-42

Электронная почта: org@eplast1.ru

Адрес: 198099, г. Санкт-Петербург, ул. Калинина, дом 2, корпус 4, литера А.