



## Film Capacitors – Power Electronic Capacitors

MKP DC

**Series/Type:**  
**Ordering code:**      **B2562\***  
Date:                      January 2013  
Version:                    8

**MKP DC**
**Construction and general data**

<b>Characteristics</b>	
Standard capacitance tolerance	K: $\pm 10\%$
Dielectric dissipation factor ( $\tan \delta_o$ )	$2 \cdot 10^{-4}$
$\Theta_{stg}$	$-55 \dots +85 \text{ }^\circ\text{C}$
Expected lifetime $t_{LD (co)}$	100 000 h at $\Theta_{hs} +75^\circ\text{C}$ (refer to section 1)
Fit rate	200 (refer to section 2)
Minimum temperature $\Theta_{min.}$	$-55 \text{ }^\circ\text{C}$
Maximum temperature $\Theta_{max.}$	$+70 \text{ }^\circ\text{C}$ (refer to section 2)
Storage temperature $\Theta_{stg}$	$-55 \dots +85 \text{ }^\circ\text{C}$
Maximum hotspot temperature $\Theta_{hs}$ (refer to section 1)	$+85 \text{ }^\circ\text{C}$ for diameter 85 and 90 mm $+75 \text{ }^\circ\text{C}$ for diameter 116 mm
Climatic category	55/70/56
Maximum altitude	2000 m above sea level (derating curves available upon request)

<b>Test data</b>	
Voltage between terminals $V_{TT}$	1.5 $V_{DC}$ , 10s
Voltage between terminals and case $V_{TC}$	4000 $V_{AC}$ , 10s
Dissipation factor $\tan \delta$ (100 Hz)	$\leq 1.0 \cdot 10^{-3}$
Life test	According to IEC 61071
Cooling	Naturally air-cooled (or forced air cooling)
Degree of protection	Indoor mounting

<b>Design data</b>	
Impregnation	Resin filling: Non PCB, hard polyurethane (dry type)
Mounting and grounding	M12 threaded bolt on bottom of the aluminum case
Max. torque (case) M12 stud	10 Nm
Max. torque terminal	Female M6: 5 Nm Female M8: 6 Nm Male M8: 8 Nm

<b>Reference standards</b>	
IEC 61071	
RoHS compliance	
Certification: UL 810-5th edition (refer to table 1.3)	

**MKP DC**

1.1 Structure of ordering code



1.2 Standard types:

Diameter (Ø) Terminal type		D (mm)	32 ± 0.5	45 ± 0.5	50 ± 0.5
		OC ending	-**1	-**4	-**3
85 mm	Female M6 (B25620)		standard		
	Male M8 (B25623)			standard	
90 mm	Female M6 (B25620)			available	
	Female M6 (B25620)				standard

Other terminal configurations available upon request.

1.3 UL approved types:

Diameter (Ø)	Series
85 mm	B2562xC B2562xD
90 mm	all types
116 mm	all types

1.4 Drawings types:

Figure 1: - B25620B - Ø 85mm  
 - Female terminals (M6)  
 - Between terminals  $32 \pm 0.5$ mm



Figure 2: - B25620C / B25620D - Ø 85mm  
 - Female terminals (M6)  
 - Between terminals  $32 \pm 0.5$ mm



MKP DC

Figure 3 : - B25620B - Ø 90mm  
 - Male terminals (M8)  
 - Between terminals 45±0.5mm

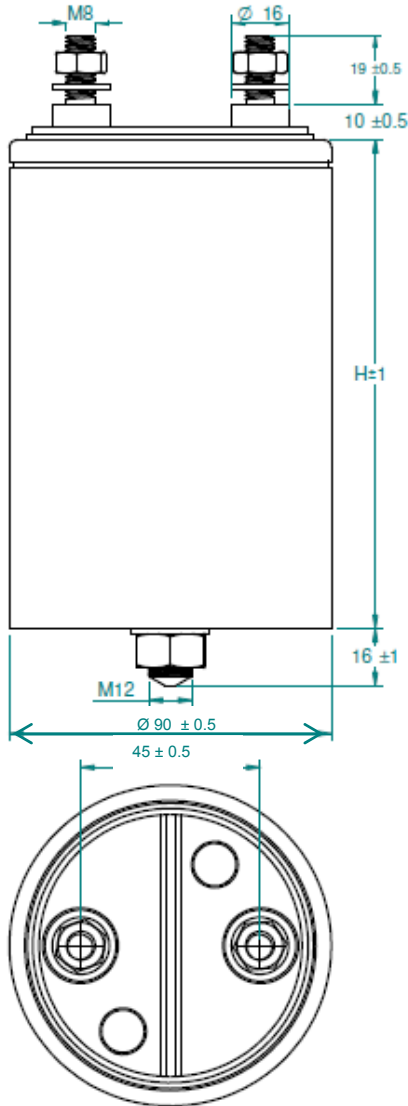
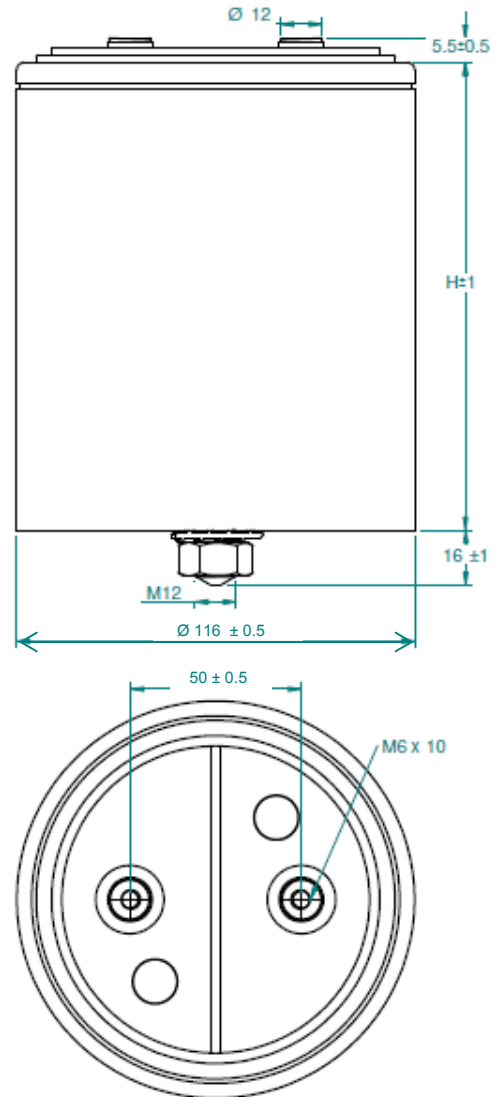

Figure 4: - B25620B - Ø 116mm  
 - Female terminals (M6)  
 - Between terminals 50±0.5mm



M12 stud on bottom of the aluminum case, nut and washer for fixing are standard for all types.

### Terms and characteristics

The following definitions apply to power capacitors according to IEC 61071.

#### **Rated capacitance $C_N$**

Nominal value of the capacitance at 20 °C and measuring frequency range of 50 to 120 Hz.

#### **Rated DC voltage $V_{RDC}$**

Maximum operating peak voltage of either polarity but of a non-reversing type wave form, for which the capacitor has been designed, for continuous operation.

#### **Ripple voltage $V_r$**

Peak-to-peak alternating component of the unidirectional voltage.

#### **Maximum surge voltage $V_s$**

Peak voltage induced by a switching or any other disturbance of the system which is allowed for a limited number of times and duration.

- Maximum duration: 50 ms / pulse

- Maximum number of occurrences: 1000 (during load)

#### **Insulation voltage $V_i$**

Rms rated value of the insulation voltage of capacitive elements and terminals to case or earth. When it is not specified in the product data sheet, the insulation voltage is at least:

$$V_i = \frac{V_R}{\sqrt{2}}$$

#### **Maximum rate of voltage rise $(dV/dt)_{max}$**

Maximum permissible repetitive rate of voltage rise of the operational voltage.

#### **Maximum current $I_{max}$**

Maximum rms current for continuous operation.

#### **Maximum peak current $\hat{I}$**

Maximum permissible repetitive current amplitude during continuous operation.

Maximum peak current ( $\hat{I}$ ) and maximum rate of voltage rise  $(dV/dt)_{max}$  on a capacitor are related as follows:

$$\hat{I} = C \cdot (dV/dt)_{max}$$

#### **Maximum surge current $\hat{I}_s$**

Admissible peak current induced by a switching or any other disturbance of the system which is allowed for a limited number of times (1000 times) and duration (50 ms / pulse).

$$\hat{I}_s = C \cdot (dV/dt)_s$$

#### **Ambient temperature $\Theta_A$**

Temperature of the surrounding air, measured at 10 cm distance and 2/3 of the case height of the capacitor.

#### **Lowest operating temperature $\Theta_{min}$**

Lowest permitted ambient temperature at which a capacitor may be energized.

**Maximum operating temperature  $\Theta_{\max}$** 

Highest permitted capacitor temperature during operation, i.e. temperature at the hottest point of the case.

**Hot-spot temperature  $\Theta_{\text{hs}} / T_{\text{hs}}$** 

Temperature zone inside of the capacitor at hottest spot.

**Tangent of the loss angle of a capacitor  $\tan \delta$** 

Ratio between the equivalent series resistance and the capacitive reactance of a capacitor at a specified sinusoidal alternating voltage, frequency and temperature.

**Series resistance  $R_s$** 

The sum of all Ohmic resistances occurring inside the capacitor.

**ESR**

ESR (Equivalent Series Resistance) representing entire active power in capacitor.

$$\text{ESR} = \frac{\tan \delta}{\omega \cdot C} = R_s + \frac{\tan \delta_0}{\omega \cdot C}$$

**Thermal resistance  $R_{\text{th}}$** 

The thermal resistance indicates by how many degrees the capacitor temperature at the hot spot rises in relation to the dissipation losses.

**Maximum power loss  $P_{\max}$** 

Maximum permissible power dissipation for the capacitor's operation.

$$P_{\max} = \frac{\Theta_{\text{hs}} - \Theta_A}{R_{\text{th}}}$$

**Self inductance  $L_{\text{self}}$** 

The sum of all inductive elements which are contained in a capacitor.

**Resonance frequency  $f_r$** 

The lowest frequency at which the impedance of the capacitor becomes minimum.

$$f_r = \frac{1}{2\pi \cdot \sqrt{L_{\text{self}} \cdot C_R}}$$

**MKP DC**
 **$V_R = 700 \text{ V DC} / V_{TT} = 1050 \text{ V DC}, 10\text{s} / V_{TC} = 4000 \text{ V AC}, 10\text{s}$** 

$C_R$ $\mu\text{F}$	$I_{MAX}^1$ A	$I_s$ kA	$\hat{I}$ kA	$R_S$ m $\Omega$	$L_{self}$ nH	$R_{TH}$ K/W	D mm	H mm	Weight kg	Fig.	Ordering code
280	55	12.1	4.0	1.2	$\leq 40$	5.4	85	70	0.45	1	B25620B0287K701
500	60	13.5	4.5	1.4	$\leq 40$	3.7	90	95	0.73	3	B25623B0507K704
560	80	24.2	8.0	0.9	$\leq 40$	4.0	116	70	0.88	4	B25620B0567K703
620	55	12.1	4.0	1.9	$\leq 40$	3.1	85	120	0.71	1	B25620B0627K701
700	55	12.1	4.0	2.0	$\leq 40$	2.8	85	132	0.87	1	B25620B0707K701
780	65	13.4	4.5	1.9	$\leq 40$	2.7	90	132	1.00	3	B25623B0787K703
900	80	24.3	8.0	1.1	$\leq 40$	2.9	116	95	1.13	4	B25620B0907K703
1240	80	24.3	8.1	1.3	$\leq 40$	2.3	116	120	1.40	4	B25620B0128K743
1400	80	24.1	8.0	1.4	$\leq 40$	2.1	116	132	1.55	4	B25620B0148K703

 **$V_R = 900 \text{ V DC} / V_{TT} = 1350\text{V DC}, 10\text{s} / V_{TC} = 4000 \text{ V AC}, 10\text{s}$** 

$C_R$ $\mu\text{F}$	$I_{MAX}^1$ A	$I_s$ kA	$\hat{I}$ kA	$R_S$ m $\Omega$	$L_{self}$ nH	$R_{TH}$ K/W	D mm	H mm	Weight kg	Fig.	Ordering code
220	50	10.8	3.6	1.3	$\leq 40$	5.4	85	70	0.45	1	B25620B0227K881
220	50	10.8	3.6	1.3	$\leq 40$	5.4	85	73	0.48	2	B25620C0227K881
350	50	10.7	3.6	1.7	$\leq 40$	3.9	85	95	0.58	1	B25620B0357K881
350	50	10.7	3.6	1.7	$\leq 40$	3.9	85	98	0.61	2	B25620C0357K881
420	60	11.9	4.0	1.5	$\leq 40$	3.7	90	95	0.73	3	B25623B0427K904
440	65	21.7	7.2	1.1	$\leq 40$	3.8	116	70	0.88	4	B25620B0447K883
480	55	10.8	3.6	2.8	$\leq 40$	3.1	85	120	0.71	1	B25620B0487K881
480	55	10.8	3.6	2.1	$\leq 40$	3.1	85	123	0.74	2	B25620C0487K881
550	50	11	3.7	2.3	$\leq 40$	2.8	85	132	0.87	1	B25620B0557K881
550	50	11	3.7	2.3	$\leq 40$	2.8	85	135	0.9	2	B25620C0557K881
580	62	11.9	4.0	1.9	$\leq 40$	3.0	90	120	0.9	3	B25623B0587K904
650	62	11.8	3.9	2.1	$\leq 40$	2.7	90	132	1	3	B25623B0657K904
700	70	21.5	7.1	1.2	$\leq 40$	2.9	116	95	1.13	4	B25620B0707K883
730	62	11.8	3.9	2.2	$\leq 60$	2.4	90	145	1.2	3	B25623B0737K904
750	55	23.1	7.7	1.2	$\leq 60$	2.2	85	173	1.1	1	B25620B0757K881
750	55	23.1	7.7	1.2	$\leq 60$	2.2	85	176	1.13	2	B25620C0757K881
830	58	23.5	7.8	0.7	$\leq 60$	2.1	90	173	1.3	3	B25623B0837K904
970	75	21.7	7.2	1.4	$\leq 40$	2.3	116	120	1.4	4	B25620B0977K883
1100	75	21.7	7.2	1.6	$\leq 40$	2.1	116	132	1.55	4	B25620B0118K883
1500	80	43	15.4	1.1	$\leq 60$	1.6	116	173	1.945	4	B25620B0158K883

<sup>1</sup>  $I_{MAX}$  at  $\Theta 40^\circ\text{C}$ , refer to "current derating" section for more details

Other configurations and capacitance tolerances available upon request



**MKP DC**
 **$V_R = 1100 \text{ V DC} / V_{TT} = 1650 \text{ V DC}, 10\text{s} / V_{TC} = 4000 \text{ V AC}, 10\text{s}$** 

$C_R$ $\mu\text{F}$	$I_{MAX}^1$ A	$I_s$ kA	$\hat{I}$ kA	$R_S$ m $\Omega$	$L_{self}$ nH	$R_{TH}$ K/W	D mm	H mm	Weight kg	Fig.	Ordering code
140	50	8.6	2.9	1.4	$\leq 40$	5.4	85	70	0.45	1	B25620B1147K101
140	50	8.6	2.9	1.4	$\leq 40$	5.4	85	73	0.48	2	B25620C1147K101
220	54	9.5	3.2	1.5	$\leq 40$	4.3	90	83	0.53	3	B25623B1227K104
270	55	9.6	3.2	1.7	$\leq 40$	3.7	90	95	0.73	3	B25623B1277K104
280	75	17.2	5.7	1.0	$\leq 40$	4	116	70	0.9	4	B25620B1287K103
310	50	8.6	2.9	2.3	$\leq 40$	3.1	85	120	0.71	1	B25620B1317K101
310	50	8.6	2.9	2.3	$\leq 40$	3.1	85	123	0.73	2	B25620C1317K101
370	56	9.5	3.2	2.2	$\leq 40$	3.0	90	120	0.9	3	B25623B1377K104
400	63	8.8	2.9	2.4	$\leq 40$	2.8	85	132	0.87	1	B25620B1407K101
400	63	8.8	2.9	2.4	$\leq 40$	2.8	85	135	0.9	2	B25620C1407K101
400	75	17.3	5.8	1.5	$\leq 40$	2.2	85	151	1	2	B25620D1407K101
420	63	8.8	2.9	2.4	$\leq 40$	2.8	85	135	0.87	1	B25620B1427A101*
420	63	8.8	2.9	2.4	$\leq 40$	2.8	85	138	0.9	2	B25620C1427A101*
420	75	17.3	5.8	1.5	$\leq 40$	2.2	85	151	1	2	B25620D1427K101
420	56	9.5	3.2	2.4	$\leq 40$	2.7	90	132	1	3	B25623B1427K104
450	75	16.5	5.4	1.3	$\leq 40$	2.9	116	95	1.13	4	B25620B1457K103
450	80	17.3	5.8	1.0	$\leq 60$	2.2	85	176	1.05	2	B25620D1457K101
470	56	9.5	3.2	2.6	$\leq 40$	2.4	90	145	1.2	3	B25623B1477K104
480	80	17.3	5.8	1.0	$\leq 60$	2.2	85	173	1.05	1	B25620B1487K101
480	80	17.3	5.8	1.0	$\leq 60$	2.2	85	176	1.08	2	B25620C1487K101
530	53	18.8	6.3	0.8	$\leq 60$	2.1	90	173	1.3	3	B25623B1537K104
610	80	16.8	5.6	3.13	$\leq 40$	2.3	116	120	1.4	4	B25620B1617K103
610	80	17	5.7	1.1	$\leq 60$	1.7	85	226	2.2	2	B25620D1617K101
700	80	16.8	5.6	1.7	$\leq 40$	2.1	116	132	1.55	4	B25620B1707K103
700	80	27	8.9	1.1	$\leq 60$	1.7	116	176	2.05	4	B25620D1707K103
940	80	32.7	11	0.7	$\leq 60$	1.6	116	173	2.06	4	B25620B1947K103
1100	80	30.8	10.3	0.8	$\leq 100$	1.3	116	223	2.56	4	B25620B1118K103
1500	80	32.5	10.8	0.9	$\leq 90$	1	116	295	2.8	4	B25620B1158K103

\* Capacitance tolerance A: -15% ... 0%

<sup>1</sup>  $I_{MAX}$  at  $\Theta 40^\circ\text{C}$ , refer to “current derating” section for more details

Other configurations and capacitance tolerances available upon request

**MKP DC**
 **$V_R = 1200 \text{ V DC} / V_{TT} = 1800 \text{ V DC}, 10\text{s} / V_{TC} = 4000 \text{ V AC}, 10\text{s}$** 

$C_R$ $\mu\text{F}$	$I_{MAX}$ <sup>1</sup> A	$I_s$ kA	$\hat{I}$ kA	$R_S$ m $\Omega$	$L_{self}$ nH	$R_{TH}$ K/W	D mm	H mm	Weight kg	Fig.	Ordering code
220	50	8.6	2.9	1.9	≤ 40	3.7	90	95	0.73	3	B25623B1227K204
300	50	8.5	2.8	2.4	≤ 40	3.0	90	120	0.9	3	B25623B1307K204
340	50	8.5	2.8	2.6	≤ 40	2.7	90	132	1	3	B25623B1347K204
360	70	15.223	5.074	1.341	≤ 40	2.9	116	95	1.13	4	B25620B1367K203
440	52	17.1	5.7	0.8	≤ 60	2.1	90	173	1.3	3	B25623B1447K204
500	75	15.379	5.126	1.614	≤ 40	2.29	116	120	1.4	4	B25620B1507K203
550	80	16.917	5.639	0.987	≤ 90	1.59	90	223	1.4	3	B25623B1557K204
570	75	15.429	5.143	1.751	≤ 40	2.07	116	133	1.55	4	B25620B1577K203
730	80	30.869	10.29	0.69	≤ 60	1.59	116	173	2.05	4	B25620B1737K203
1000	80	30.758	10.253	0.807	≤ 90	1.23	116	223	2.56	4	B25620B1108K203

 **$V_R = 1320 \text{ V DC} / V_{TT} = 1980 \text{ V DC}, 10\text{s} / V_{TC} = 4000 \text{ V AC}, 10\text{s}$** 

$C_R$ $\mu\text{F}$	$I_{MAX}$ <sup>1</sup> A	$I_s$ kA	$\hat{I}$ kA	$R_S$ m $\Omega$	$L_{self}$ nH	$R_{TH}$ K/W	D mm	H mm	Weight kg	Fig.	Ordering code
190	51	8.1	2.7	1.9	≤ 40	3.7	90	95	0.73	3	B25623B1197K304
220	45	7.4	2.5	2.6	≤ 40	3.1	85	120	0.71	1	B25620B1227K321
220	45	7.4	2.5	2.6	≤ 40	3.1	85	123	0.73	2	B25620C1227K321
250	51	7.7	2.6	2.5	≤ 40	3.0	90	120	0.9	3	B25623B1257K304
260	45	7.6	2.6	2.7	≤ 40	2.8	85	132	0.87	1	B25620B1267K321
260	45	7.6	2.6	2.7	≤ 40	2.8	85	135	0.9	2	B25620C1267K321
290	52	7.9	2.6	2.7	≤ 40	2.7	90	132	1	3	B25623B1297K304
310	65	14.3	4.8	1.4	≤ 40	2.9	116	95	1.13	4	B25620B1317K323
330	52	7.9	2.6	3.0	≤ 60	2.4	90	145	1.2	3	B25623B1337K304
340	70	14.8	5	0.9	≤ 60	1.6	85	173	1.05	1	B25620B1347K321
340	70	14.8	5	0.9	≤ 60	1.6	85	176	1.08	2	B25620C1347K321
370	50	15.7	5.2	0.8	≤ 60	2.1	90	173	1.3	3	B25623B0377K304
420	65	14.1	4.7	1.7	≤ 40	2.3	116	120	1.4	4	B25620B1427K323
480	70	14.1	4.7	1.8	≤ 40	2.1	116	132	1.55	4	B25620B1487K323
660	70	27.8	9.3	0.8	≤ 90	1.6	116	173	2.05	4	B25620B1667K323
1000	80	26.4	8.8	1	≤ 90	1	116	273	2.8	4	B25620B1108K323

<sup>1</sup>  $I_{MAX}$  at  $\Theta 40^\circ\text{C}$ , refer to “current derating” section for more details  
Other configurations and capacitance tolerances available upon request

**$V_R = 1980 \text{ V DC} / V_{TT} = 2970 \text{ V DC}, 10\text{s} / V_{TC} = 4000 \text{ V AC}, 10\text{s}$** 

$C_R$ $\mu\text{F}$	$I_{MAX}^1$ A	$I_s$ kA	$\hat{I}$ kA	$R_S$ m $\Omega$	$L_{self}$ nH	$R_{TH}$ K/W	D mm	H mm	Weight kg	Fig.	Ordering Code
40	35	4.5	1.5	2.1	$\leq 60$	5.4	85	70	0.45	1	B25620B1406K981
40	35	4.5	1.5	2.1	$\leq 60$	5.4	85	73	0.48	2	B25620C1406K981
70	40	4.9	1.6	2.8	$\leq 60$	4	85	95	0.58	1	B25620B1706K981
70	40	4.9	1.6	2.8	$\leq 60$	4	85	98	0.61	2	B25620C1706K981
145	50	10	3.4	1.1	$\leq 60$	2.2	85	173	1.05	1	B25620B1147K981
145	50	10	3.4	1.1	$\leq 60$	2.2	85	176	1.08	2	B25620C1147K981
190	60	18.9	6.3	0.7	$\leq 60$	2.3	116	120	1.4	4	B25620B1197K983
215	60	9.6	3.2	2.4	$\leq 40$	2.1	116	132	1.55	4	B25620B1217K983
295	70	18.8	6.3	0.8	$\leq 60$	1.6	116	173	2.05	4	B25620B1297K983
460	80	18.2	6	1.1	$\leq 90$	1	116	263	2.6	4	B25620B1467K983

<sup>1</sup>  $I_{MAX}$  at  $\Theta 40^\circ\text{C}$ , refer to “current derating” section for more details

Other configurations and capacitance tolerances available upon request

**2. Expected lifetime**

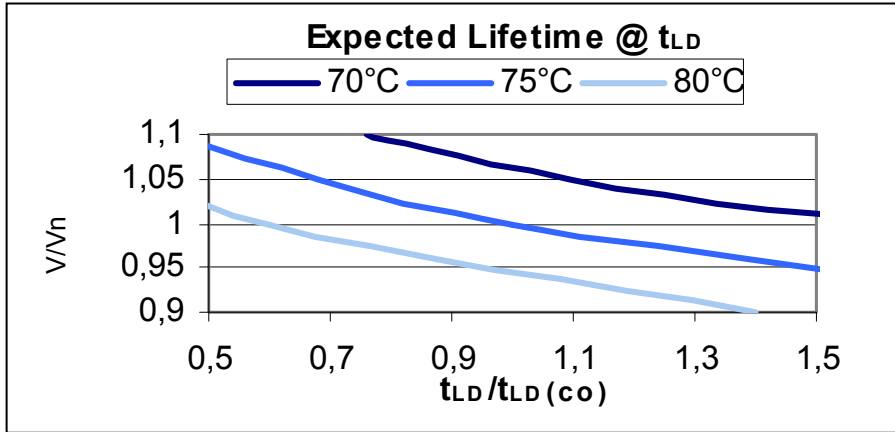

Expected lifetime  $t_{id}$  at different hotspot temperature ( $\Theta_{hs}$ ) and voltage V

For short term operation (maximum 10% of the total expected lifetime) and capacitors with diameter 85 and 90 mm a maximum hot spot temperature of 85°C is allowed without further reduction of the lifetime.

**3. Current derating**

**3.1 Current derating graphs for capacitors 700 V DC**

**B25620B0287K701**

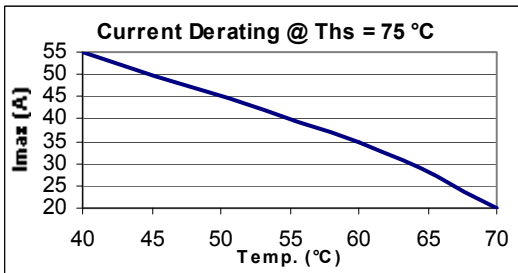

**B25620B0627K701**

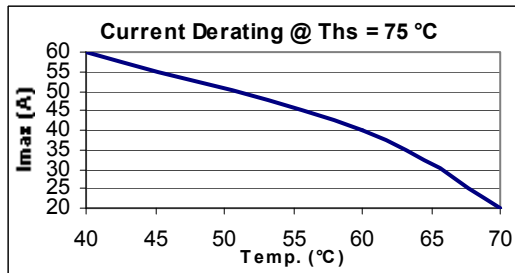

**B25620B0707K701**



**B25620B0567K703**

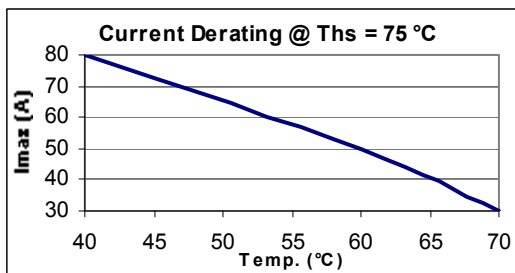

**B25620B0907K703**

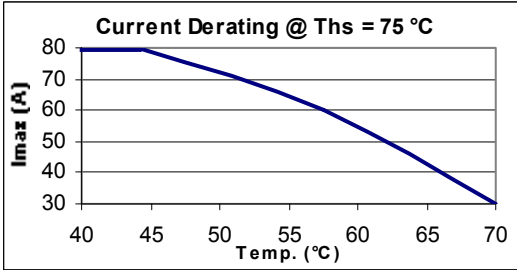

**B25620B0128K743**



**B25620B0148K703**

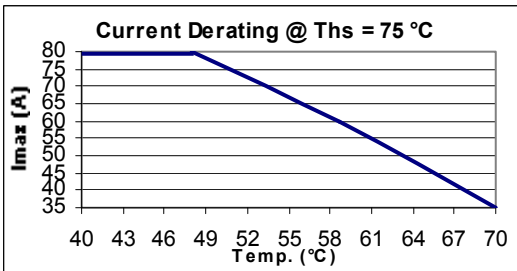

**B25620B0507K704**

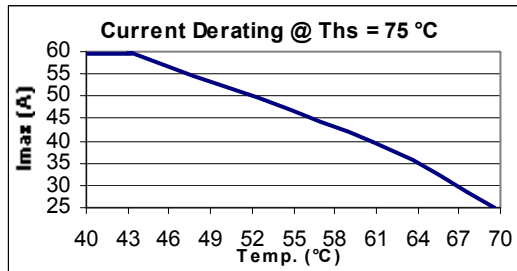

**B25620B0787K704**

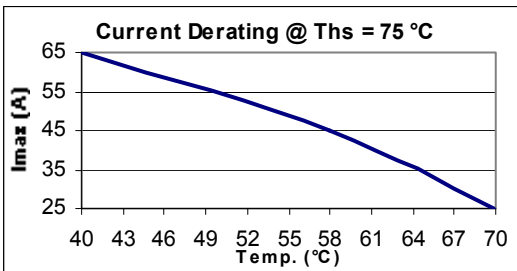

**3.2 Current derating graphs for capacitors 1100 V DC**

**B25620B1147K101**

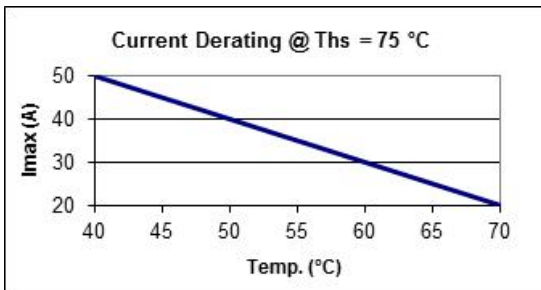

**B25620B1287K103**

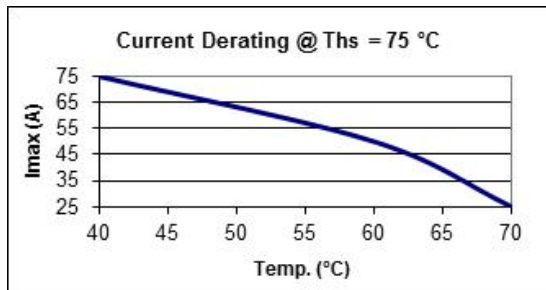

**MKP DC**

**B25620B1317K101**

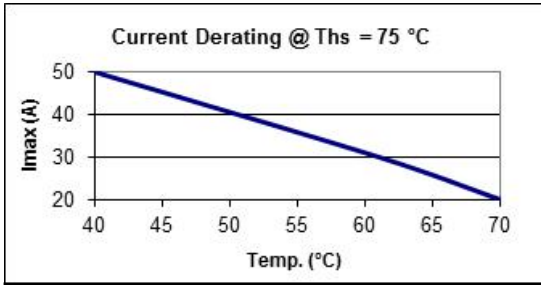

**B25620B1407K101/B25620B1427A101**

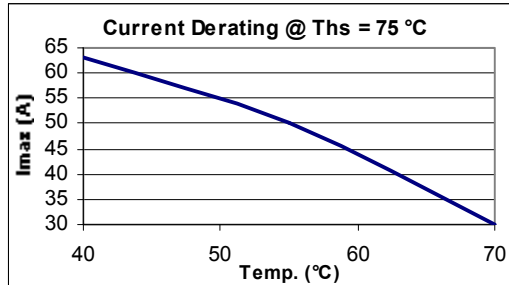

**B25620D1427K101**



**B25620D1457K101**

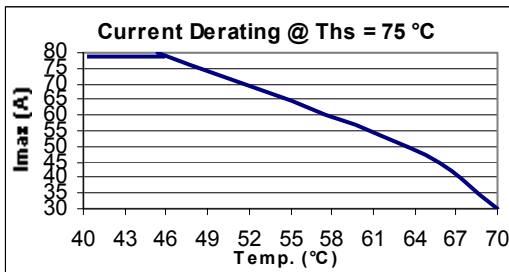

**B25620B1457K103**



**B25620B1487K101**

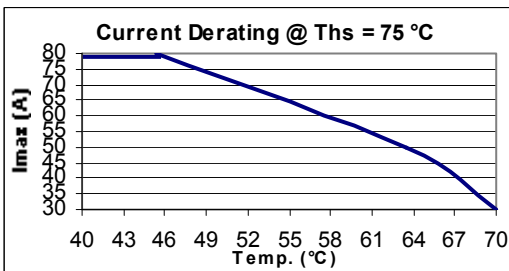

**B25620B1617K103**



**B25620D1617K101**

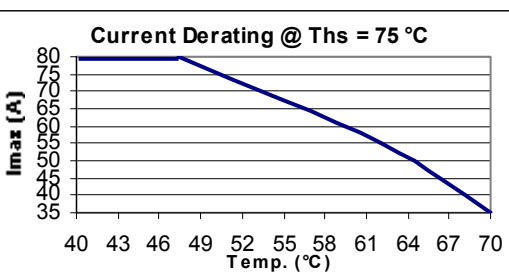

**MKP DC**

**B25620B1707K103**

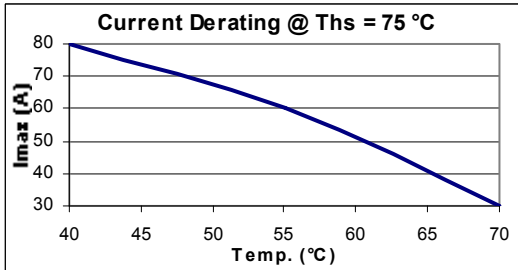

**B25620D1707K103**

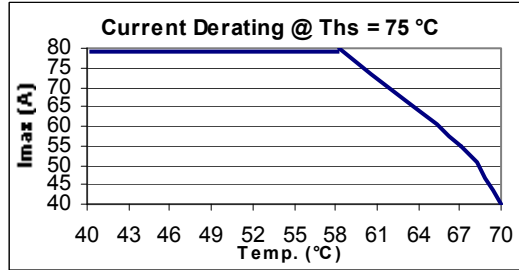

**B25620B1947K103**

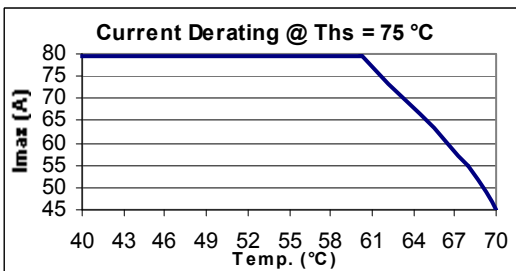

**B25620B1118K103**

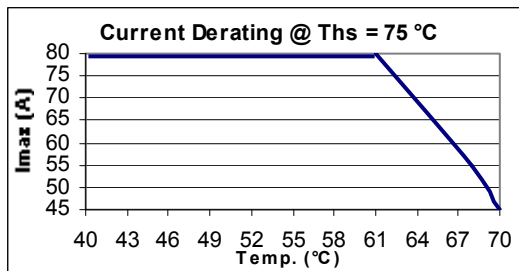

**B25620B1158K103**

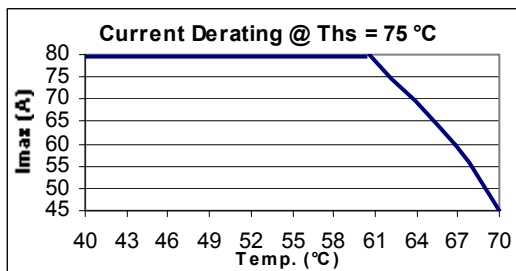

**B25620B1227K104**

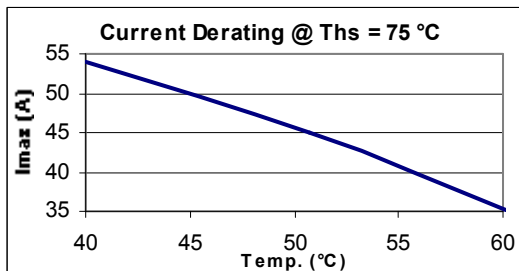

**B25620B1277K104**

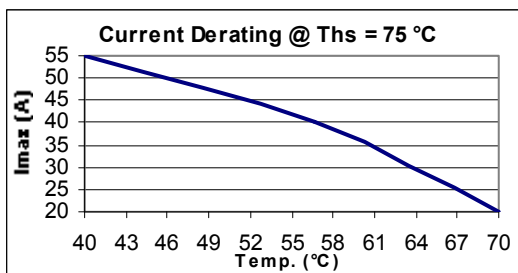

**B25620B1377K104**

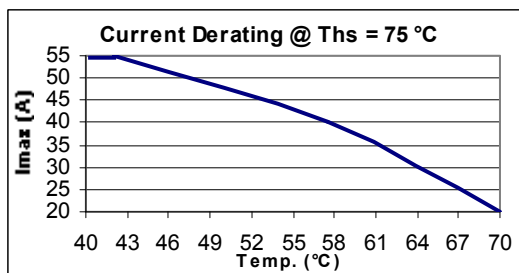

**B25620B1427K104**



**B25620B1477K104**

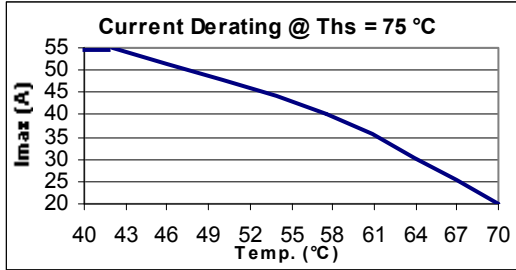

**B25620B1537K104**

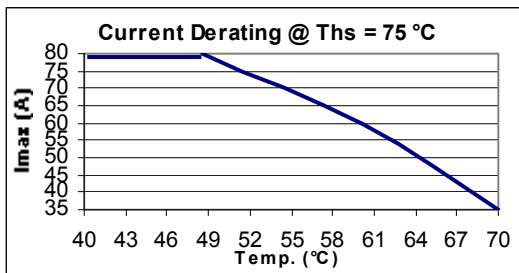

**3.3 Current derating graphs for capacitors 1200 V DC**

**B25620B1227K204**

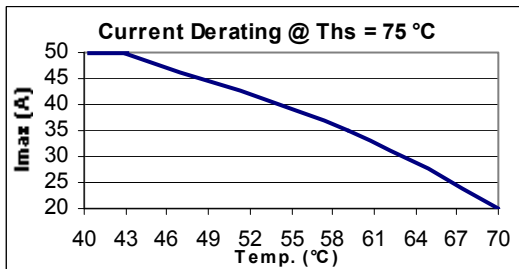

**B25620B1307K204**

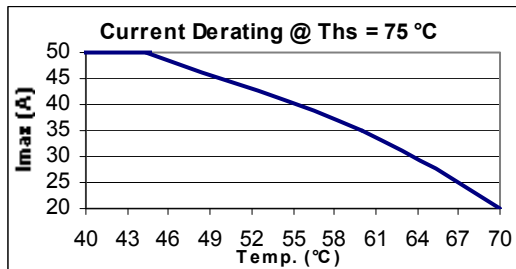

**B25620B1347K204**

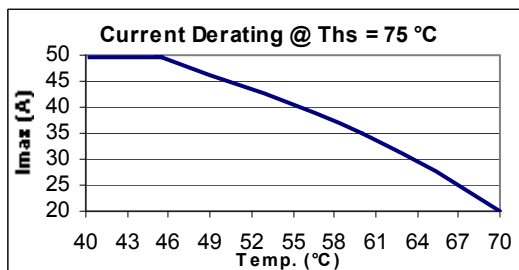

**B25620B1447K204**

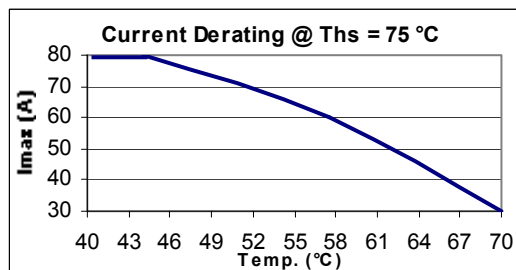



**B25620B1557K204**



**B25620B1367K203**



**B25620B1507K203**



**B25620B1577K203**



**B25620B1737K203**



**B25620B1108K203**



Current derating graphs for capacitors rated 900 / 1320 / 1980 V DC are available upon request.

4. FIT



### Cautions and warnings

- In case of dents of more than 1 mm depth or any other mechanical damage, capacitors must not be used at all.
- Check tightness of the connections/terminals periodically.
- The energy stored in capacitors may be lethal. To prevent any chance of shock, discharge and short-circuit the capacitor before handling.
- Failure to follow cautions may result, worst case, in premature failures, bursting and fire.
- EPCOS AG is not responsible for any kind of possible damages to persons or things due to improper installation and application of capacitors for power electronics.

### Safety

- Electrical or mechanical misapplication of capacitors may be hazardous. Personal injury or property damage may result from bursting of the capacitor or from expulsion of oil or melted material due to mechanical disruption of the capacitor.
- Ensure good, effective grounding for capacitor enclosures.
- Observe appropriate safety precautions during operation (self-recharging phenomena and the high energy contained in capacitors).
- Handle capacitors carefully, because they may still be charged even after disconnection.
- The terminals of capacitors, connected bus bars and cables as well as other devices may also be energized.
- Follow good engineering practice.

### Thermal load

After installation of the capacitor it is necessary to verify that maximum hot-spot temperature is not exceeded at extreme service conditions.

### Mechanical protection

The capacitor has to be installed in a way that mechanical damages and dents in the aluminum can are avoided.

### Storage and operating conditions

Do not use or store capacitors in corrosive atmosphere, especially where chloride gas, sulfide gas, acid, alkali, salt or the like are present. In dusty environments regular maintenance and cleaning especially of the terminals is required to avoid conductive path between phases and/or phases and ground.

The maximum storage temperature is 85 °C.

### Service life expectancy

Electrical components do not have an unlimited service life expectancy; this applies to self-healing capacitors, too. The maximum service life expectancy may vary depending on the application the capacitor is used in.

## Important notes

The following applies to all products named in this publication:

1. Some parts of this publication contain **statements about the suitability of our products for certain areas of application**. These statements are based on our knowledge of typical requirements that are often placed on our products in the areas of application concerned. We nevertheless expressly point out **that such statements cannot be regarded as binding statements about the suitability of our products for a particular customer application**. As a rule, EPCOS is either unfamiliar with individual customer applications or less familiar with them than the customers themselves. For these reasons, it is always ultimately incumbent on the customer to check and decide whether an EPCOS product with the properties described in the product specification is suitable for use in a particular customer application.
2. We also point out that **in individual cases, a malfunction of electronic components or failure before the end of their usual service life cannot be completely ruled out in the current state of the art, even if they are operated as specified**. In customer applications requiring a very high level of operational safety and especially in customer applications in which the malfunction or failure of an electronic component could endanger human life or health (e.g. in accident prevention or life-saving systems), it must therefore be ensured by means of suitable design of the customer application or other action taken by the customer (e.g. installation of protective circuitry or redundancy) that no injury or damage is sustained by third parties in the event of malfunction or failure of an electronic component.
3. **The warnings, cautions and product-specific notes must be observed.**
4. In order to satisfy certain technical requirements, **some of the products described in this publication may contain substances subject to restrictions in certain jurisdictions (e.g. because they are classed as hazardous)**. Useful information on this will be found in our Material Data Sheets on the Internet ([www.epcos.com/material](http://www.epcos.com/material)). Should you have any more detailed questions, please contact our sales offices.
5. We constantly strive to improve our products. Consequently, **the products described in this publication may change from time to time**. The same is true of the corresponding product specifications. Please check therefore to what extent product descriptions and specifications contained in this publication are still applicable before or when you place an order. We also **reserve the right to discontinue production and delivery of products**. Consequently, we cannot guarantee that all products named in this publication will always be available. The aforementioned does not apply in the case of individual agreements deviating from the foregoing for customer-specific products.
6. Unless otherwise agreed in individual contracts, **all orders are subject to the current version of the "General Terms of Delivery for Products and Services in the Electrical Industry" published by the German Electrical and Electronics Industry Association (ZVEI)**.
7. The trade names EPCOS, BAOKE, Alu-X, CeraDiode, CeraLink, CSMP, CSSP, CTVS, DeltaCap, DigiSiMic, DSSP, FilterCap, FormFit, MiniBlue, MiniCell, MKD, MKK, MLSC, MotorCap, PCC, PhaseCap, PhaseCube, PhaseMod, PhiCap, SIFERRIT, SIFI, SIKOREL, SilverCap, SIMDAD, SiMic, SIMID, SineFormer, SIOV, SIP5D, SIP5K, ThermoFuse, WindCap are **trademarks registered or pending** in Europe and in other countries. Further information will be found on the Internet at [www.epcos.com/trademarks](http://www.epcos.com/trademarks).



Компания «ЭлектроПласт» предлагает заключение долгосрочных отношений при поставках импортных электронных компонентов на взаимовыгодных условиях!

Наши преимущества:

- Оперативные поставки широкого спектра электронных компонентов отечественного и импортного производства напрямую от производителей и с крупнейших мировых складов;
- Поставка более 17-ти миллионов наименований электронных компонентов;
- Поставка сложных, дефицитных, либо снятых с производства позиций;
- Оперативные сроки поставки под заказ (от 5 рабочих дней);
- Экспресс доставка в любую точку России;
- Техническая поддержка проекта, помощь в подборе аналогов, поставка прототипов;
- Система менеджмента качества сертифицирована по Международному стандарту ISO 9001;
- Лицензия ФСБ на осуществление работ с использованием сведений, составляющих государственную тайну;
- Поставка специализированных компонентов (Xilinx, Altera, Analog Devices, Intersil, Interpoint, Microsemi, Aeroflex, Peregrine, Syfer, Eurofarad, Texas Instrument, Miteq, Cobham, E2V, MA-COM, Hittite, Mini-Circuits, General Dynamics и др.);

Помимо этого, одним из направлений компании «ЭлектроПласт» является направление «Источники питания». Мы предлагаем Вам помощь Конструкторского отдела:

- Подбор оптимального решения, техническое обоснование при выборе компонента;
- Подбор аналогов;
- Консультации по применению компонента;
- Поставка образцов и прототипов;
- Техническая поддержка проекта;
- Защита от снятия компонента с производства.



#### Как с нами связаться

**Телефон:** 8 (812) 309 58 32 (многоканальный)

**Факс:** 8 (812) 320-02-42

**Электронная почта:** [org@eplast1.ru](mailto:org@eplast1.ru)

**Адрес:** 198099, г. Санкт-Петербург, ул. Калинина, дом 2, корпус 4, литера А.