

A16

Separate Construction with Cylindrical 16-dia. Body

- Miniature design of 28.5 mm, the smallest class in the industry.
- Detachable Switch Unit.
- The same contacts can be used for both standard loads and microloads.
- Easy-to-wire terminal arrangement.
- Certified for EN 60947-5-1.



 Refer to *Safety Precautions for All Pushbutton Switches* and *Safety Precautions* on page 24.

List of Models

| | Model | | |
|--|---|---|---|
| | Rectangular | Square | Round |
| Solder terminals |  A16□-J Series |  A16□-A Series |  A16□-T Series |
| PCB terminals |  A16□-J Series |  A16□-A Series |  A16□-T Series |
| Voltage-reduction lighting solder terminals |  A16□-J Series |  A16□-A Series |  A16□-T Series |
| Screw-less clamp models |  A16□-J Series |  A16□-A Series |  A16□-T Series |

Model Number Structure

Model Number Legend The model numbers used to order sets of Units are illustrated below. One set comprises the Pushbutton, Lamp (lighted models only), Case, and Switch. For information on combinations, refer to Ordering Information on pages 3 to 7.

(1) (2) (3) (4) (5) (6) (7)
A 1 6 5 L - J R M - 24D - 2

(1) Degree of Protection

| Symbol | Protection |
|-----------|--------------------|
| No symbol | IP40 |
| 5 | Oil-resistant IP65 |

(2) Lighted/Non-lighted

| Symbol | Type |
|-----------|-------------|
| No symbol | Non-lighted |
| L | Lighted |

(3) Shape of Pushbutton

| Symbol | Shape | |
|--------|-------------|------------------|
| J | Rectangular | 2-way guard |
| A | Square | 2-way guard |
| T | Round | Projecting model |

(4) Color of Pushbutton

| Symbol | Color |
|--------|---------------------------------|
| R | Red |
| Y | Yellow |
| PY | Pure yellow |
| G | Green |
| W | White |
| A | Blue |
| PW | Pure white |
| B | Black (non-lighted models only) |

- Color illuminated models are also available (see page 8).
- Order the parts separately.

(5) Switch Operation

| Symbol | Operation |
|--------|-----------|
| M | Momentary |
| A | Alternate |

- ▶ Momentary-operation: Self-resetting
- ▶ Alternate-operation: Self-holding

Colored Illumination

| Unlit | Lit |
|-------|-------|
| White | Color |

The built-in LED is colored.

(7) Contact Configuration

| Symbol | Type | Terminal |
|--------|------|------------------|
| 1 | SPDT | Solder Terminal |
| 2 | DPDT | |
| 1P | SPDT | PCB Terminal |
| 2P | DPDT | |
| 2S | DPDT | Screw-less Clamp |

- Only DPDT contacts are available with Screw-Less Clamp.
- Consult your OMRON representative concerning pricing and delivery timing for PCB terminals and screw-less clamp connectors.

(6) Light Source

| Symbol | Type | Operating voltage | Rated voltage |
|-----------|-------------------|-------------------|---------------|
| No symbol | Non-lighted | | |
| 5 | Incandescent lamp | 5 VAC/VDC | 6 VAC/VDC |
| 12 | | 12 VAC/VDC | 14 VAC/VDC |
| 24 | | 24 VAC/VDC | 28 VAC/VDC |
| 5D | LED | 5 ± 5% VDC | 5 VDC |
| 12D | | 12 ± 5% VAC/VDC | 12 VAC/VDC |
| 24D | | 24 ± 5% VAC/VDC | 24 VAC/VDC |

Voltage Reduction Unit (24-V Built-in LED)

| Symbol | Type | Operating voltage | Rated voltage |
|--------|------|--------------------|-----------------|
| T1 | LED | 100 to 110 VAC/VDC | 100/110 VAC/VDC |
| T2 | | 200 to 220 VAC/VDC | 200/220 VAC/VDC |

- Solder terminals are available only with 100-V models.
- The Voltage Reduction Unit is not available for models with PCB terminals.
- "T2" is available only for the Screw-less Clamp type.

Ordering Information

Ordering as a Set The model numbers used to order sets of Units are given in the following tables. One set comprises the Pushbutton, Lamp (lighted models only), Case, and Switch.

Solder Terminal Models

Rectangular Models



IP40

A16□-J

| Output | Lighting | Item Operating voltage | Momentary operation (Self-resetting) | Alternate operation (Self-holding) | Pushbutton color symbol *1 | |
|-------------|------------------------------------|---------------------------|---|---------------------------------------|---|-----------|
| SPDT | LED without Voltage Reduction Unit | 5 VDC | A16L-J□M-5D-1 | A16L-J□A-5D-1 | R: red, Y: yellow PY: pure yellow G: green, A: blue W: white PW: pure white R: red, Y: yellow PY: pure yellow G: green, W: white A: blue B: black *2 | |
| | | 12 VAC/VDC | A16L-J□M-12D-1 | A16L-J□A-12D-1 | | |
| | | 24 VAC/VDC | A16L-J□M-24D-1 | A16L-J□A-24D-1 | | |
| | Incandescent lamp | 5 VAC/VDC | A16L-J□M-5-1 | A16L-J□A-5-1 | | |
| | | 12 VAC/VDC | A16L-J□M-12-1 | A16L-J□A-12-1 | | |
| | | 24 VAC/VDC | A16L-J□M-24-1 | A16L-J□A-24-1 | | |
| Non-lighted | | | A16-J□M-1 | A16-J□A-1 | | |
| DPDT | LED without Voltage Reduction Unit | 5 VDC | A16L-J□M-5D-2 | A16L-J□A-5D-2 | R: red, Y: yellow PY: pure yellow G: green, A: blue W: white PW: pure white R: red, Y: yellow PY: pure yellow G: green, W: white A: blue B: black *2 | |
| | | 12 VAC/VDC | A16L-J□M-12D-2 | A16L-J□A-12D-2 | | |
| | | 24 VAC/VDC | A16L-J□M-24D-2 | A16L-J□A-24D-2 | | |
| | Incandescent lamp | 5 VAC/VDC | A16L-J□M-5-2 | A16L-J□A-5-2 | | |
| | | 12 VAC/VDC | A16L-J□M-12-2 | A16L-J□A-12-2 | | |
| | | 24 VAC/VDC | A16L-J□M-24-2 | A16L-J□A-24-2 | | |
| | Non-lighted | | | A16-J□M-2 | | A16-J□A-2 |

*1. Enter the desired color symbol for the Pushbutton in the □.
*2. Black ("B") Pushbuttons are only available for non-lighted models.

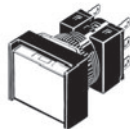

Oil-resistant IP65

| Output | Lighting | Item Operating voltage | Momentary operation (Self-resetting) | Alternate operation (Self-holding) | Pushbutton color symbol *1 | |
|-------------|------------------------------------|---------------------------|---|---------------------------------------|---|------------|
| SPDT | LED without Voltage Reduction Unit | 5 VDC | A165L-J□M-5D-1 | A165L-J□A-5D-1 | R: red, Y: yellow PY: pure yellow G: green, A: blue W: white PW: pure white R: red, Y: yellow PY: pure yellow G: green, W: white A: blue B: black *2 | |
| | | 12 VAC/VDC | A165L-J□M-12D-1 | A165L-J□A-12D-1 | | |
| | | 24 VAC/VDC | A165L-J□M-24D-1 | A165L-J□A-24D-1 | | |
| | Incandescent lamp | 5 VAC/VDC | A165L-J□M-5-1 | A165L-J□A-5-1 | | |
| | | 12 VAC/VDC | A165L-J□M-12-1 | A165L-J□A-12-1 | | |
| | | 24 VAC/VDC | A165L-J□M-24-1 | A165L-J□A-24-1 | | |
| Non-lighted | | | A165-J□M-1 | A165-J□A-1 | | |
| DPDT | LED without Voltage Reduction Unit | 5 VDC | A165L-J□M-5D-2 | A165L-J□A-5D-2 | R: red, Y: yellow PY: pure yellow G: green, A: blue W: white PW: pure white R: red, Y: yellow PY: pure yellow G: green, W: white A: blue B: black *2 | |
| | | 12 VAC/VDC | A165L-J□M-12D-2 | A165L-J□A-12D-2 | | |
| | | 24 VAC/VDC | A165L-J□M-24D-2 | A165L-J□A-24D-2 | | |
| | Incandescent lamp | 5 VAC/VDC | A165L-J□M-5-2 | A165L-J□A-5-2 | | |
| | | 12 VAC/VDC | A165L-J□M-12-2 | A165L-J□A-12-2 | | |
| | | 24 VAC/VDC | A165L-J□M-24-2 | A165L-J□A-24-2 | | |
| | Non-lighted | | | A165-J□M-2 | | A165-J□A-2 |

*1. Enter the desired color symbol for the Pushbutton in the □.
*2. Black ("B") Pushbuttons are only available for non-lighted models.

Individual models: Refer to pages 9 to 13.
(The Pushbutton, Lamp, Case, and Switch can be ordered separately.)

■ Ratings: Refer to page 16. ■ Characteristics: Refer to page 16.
■ Accessories: Refer to page 15.

Ordering Information

Ordering as a Set..... The model numbers used to order sets of Units are given in the following tables. One set comprises the Pushbutton, Lamp (lighted models only), Case, and Switch.

Solder Terminal Models

Square Models



IP40

A16□-A

| Output | Lighting | Item Operating voltage | Momentary operation (Self-resetting) | Alternate operation (Self-holding) | Pushbutton color symbol *1 |
|-------------|------------------------------------|---------------------------|---|---------------------------------------|---|
| SPDT | LED without Voltage Reduction Unit | 5 VDC | A16L-A□M-5D-1 | A16L-A□A-5D-1 | R: red, Y: yellow PY: pure yellow G: green, A: blue W: white PW: pure white |
| | | 12 VAC/VDC | A16L-A□M-12D-1 | A16L-A□A-12D-1 | |
| | | 24 VAC/VDC | A16L-A□M-24D-1 | A16L-A□A-24D-1 | |
| | Incandescent lamp | 5 VAC/VDC | A16L-A□M-5-1 | A16L-A□A-5-1 | R: red, Y: yellow PY: pure yellow G: green, W: white A: blue B: black *2 |
| | | 12 VAC/VDC | A16L-A□M-12-1 | A16L-A□A-12-1 | |
| | | 24 VAC/VDC | A16L-A□M-24-1 | A16L-A□A-24-1 | |
| Non-lighted | | | A16-A□M-1 | A16-A□A-1 | |
| DPDT | LED without Voltage Reduction Unit | 5 VDC | A16L-A□M-5D-2 | A16L-A□A-5D-2 | R: red, Y: yellow PY: pure yellow G: green, A: blue W: white PW: pure white |
| | | 12 VAC/VDC | A16L-A□M-12D-2 | A16L-A□A-12D-2 | |
| | | 24 VAC/VDC | A16L-A□M-24D-2 | A16L-A□A-24D-2 | |
| | Incandescent lamp | 5 VAC/VDC | A16L-A□M-5-2 | A16L-A□A-5-2 | R: red, Y: yellow PY: pure yellow G: green, W: white A: blue B: black *2 |
| | | 12 VAC/VDC | A16L-A□M-12-2 | A16L-A□A-12-2 | |
| | | 24 VAC/VDC | A16L-A□M-24-2 | A16L-A□A-24-2 | |
| Non-lighted | | | A16-A□M-2 | A16-A□A-2 | |

*1. Enter the desired color symbol for the Pushbutton in the □.

*2. Black ("B") Pushbuttons are only available for non-lighted models.



Oil-resistant IP65

| Output | Lighting | Item Operating voltage | Momentary operation (Self-resetting) | Alternate operation (Self-holding) | Pushbutton color symbol *1 |
|-------------|------------------------------------|---------------------------|---|---------------------------------------|---|
| SPDT | LED without Voltage Reduction Unit | 5 VDC | A165L-A□M-5D-1 | A165L-A□A-5D-1 | R: red, Y: yellow PY: pure yellow G: green, A: blue W: white PW: pure white |
| | | 12 VAC/VDC | A165L-A□M-12D-1 | A165L-A□A-12D-1 | |
| | | 24 VAC/VDC | A165L-A□M-24D-1 | A165L-A□A-24D-1 | |
| | Incandescent lamp | 5 VAC/VDC | A165L-A□M-5-1 | A165L-A□A-5-1 | R: red, Y: yellow PY: pure yellow G: green, W: white A: blue B: black *2 |
| | | 12 VAC/VDC | A165L-A□M-12-1 | A165L-A□A-12-1 | |
| | | 24 VAC/VDC | A165L-A□M-24-1 | A165L-A□A-24-1 | |
| Non-lighted | | | A165-A□M-1 | A165-A□A-1 | |
| DPDT | LED without Voltage Reduction Unit | 5 VDC | A165L-A□M-5D-2 | A165L-A□A-5D-2 | R: red, Y: yellow PY: pure yellow G: green, A: blue W: white PW: pure white |
| | | 12 VAC/VDC | A165L-A□M-12D-2 | A165L-A□A-12D-2 | |
| | | 24 VAC/VDC | A165L-A□M-24D-2 | A165L-A□A-24D-2 | |
| | Incandescent lamp | 5 VAC/VDC | A165L-A□M-5-2 | A165L-A□A-5-2 | R: red, Y: yellow PY: pure yellow G: green, W: white A: blue B: black *2 |
| | | 12 VAC/VDC | A165L-A□M-12-2 | A165L-A□A-12-2 | |
| | | 24 VAC/VDC | A165L-A□M-24-2 | A165L-A□A-24-2 | |
| Non-lighted | | | A165-A□M-2 | A165-A□A-2 | |

*1. Enter the desired color symbol for the Pushbutton in the □.

*2. Black ("B") Pushbuttons are only available for non-lighted models.

Individual models: Refer to pages 9 to 13.
(The Pushbutton, Lamp, Case, and Switch can be ordered separately.)

■ Ratings: Refer to page 16. ■ Characteristics: Refer to page 16.
■ Accessories: Refer to page 15.

Ordering Information

Ordering as a Set The model numbers used to order sets of Units are given in the following tables. One set comprises the Pushbutton, Lamp (lighted models only), Case, and Switch.

Solder Terminals

Round Models



A16□-T

IP40

| Output | Lighting | Item Operating voltage | Momentary operation (Self-resetting) | Alternate operation (Self-holding) | Pushbutton color symbol *1 |
|-------------|------------------------------------|---------------------------|---|---------------------------------------|---|
| SPDT | LED without Voltage Reduction Unit | 5 VDC | A16L-T□M-5D-1 | A16L-T□A-5D-1 | R: red, Y: yellow PY: pure yellow G: green, A: blue W: white PW: pure white |
| | | 12 VAC/VDC | A16L-T□M-12D-1 | A16L-T□A-12D-1 | |
| | | 24 VAC/VDC | A16L-T□M-24D-1 | A16L-T□A-24D-1 | |
| | Incandescent lamp | 5 VAC/VDC | A16L-T□M-5-1 | A16L-T□A-5-1 | R: red, Y: yellow PY: pure yellow G: green, W: white A: blue B: black *2 |
| | | 12 VAC/VDC | A16L-T□M-12-1 | A16L-T□A-12-1 | |
| | | 24 VAC/VDC | A16L-T□M-24-1 | A16L-T□A-24-1 | |
| Non-lighted | | | A16-T□M-1 | A16-T□A-1 | |
| DPDT | LED without Voltage Reduction Unit | 5 VDC | A16L-T□M-5D-2 | A16L-T□A-5D-2 | R: red, Y: yellow PY: pure yellow G: green, A: blue W: white PW: pure white |
| | | 12 VAC/VDC | A16L-T□M-12D-2 | A16L-T□A-12D-2 | |
| | | 24 VAC/VDC | A16L-T□M-24D-2 | A16L-T□A-24D-2 | |
| | Incandescent lamp | 5 VAC/VDC | A16L-T□M-5-2 | A16L-T□A-5-2 | R: red, Y: yellow PY: pure yellow G: green, W: white A: blue B: black *2 |
| | | 12 VAC/VDC | A16L-T□M-12-2 | A16L-T□A-12-2 | |
| | | 24 VAC/VDC | A16L-T□M-24-2 | A16L-T□A-24-2 | |
| Non-lighted | | | A16-T□M-2 | A16-T□A-2 | |

*1. Enter the desired color symbol for the Pushbutton in the □.
*2. Black ("B") Pushbuttons are only available for non-lighted models.



Oil-resistant IP65

| Output | Lighting | Item Operating voltage | Momentary operation (Self-resetting) | Alternate operation (Self-holding) | Pushbutton color symbol *1 |
|-------------|------------------------------------|---------------------------|---|---------------------------------------|---|
| SPDT | LED without Voltage Reduction Unit | 5 VDC | A165L-T□M-5D-1 | A165L-T□A-5D-1 | R: red, Y: yellow PY: pure yellow G: green, A: blue W: white PW: pure white |
| | | 12 VAC/VDC | A165L-T□M-12D-1 | A165L-T□A-12D-1 | |
| | | 24 VAC/VDC | A165L-T□M-24D-1 | A165L-T□A-24D-1 | |
| | Incandescent lamp | 5 VAC/VDC | A165L-T□M-5-1 | A165L-T□A-5-1 | R: red, Y: yellow PY: pure yellow G: green, W: white A: blue B: black *2 |
| | | 12 VAC/VDC | A165L-T□M-12-1 | A165L-T□A-12-1 | |
| | | 24 VAC/VDC | A165L-T□M-24-1 | A165L-T□A-24-1 | |
| Non-lighted | | | A165-T□M-1 | A165-T□A-1 | |
| DPDT | LED without Voltage Reduction Unit | 5 VDC | A165L-T□M-5D-2 | A165L-T□A-5D-2 | R: red, Y: yellow PY: pure yellow G: green, A: blue W: white PW: pure white |
| | | 12 VAC/VDC | A165L-T□M-12D-2 | A165L-T□A-12D-2 | |
| | | 24 VAC/VDC | A165L-T□M-24D-2 | A165L-T□A-24D-2 | |
| | Incandescent lamp | 5 VAC/VDC | A165L-T□M-5-2 | A165L-T□A-5-2 | R: red, Y: yellow PY: pure yellow G: green, W: white A: blue B: black *2 |
| | | 12 VAC/VDC | A165L-T□M-12-2 | A165L-T□A-12-2 | |
| | | 24 VAC/VDC | A165L-T□M-24-2 | A165L-T□A-24-2 | |
| Non-lighted | | | A165-T□M-2 | A165-T□A-2 | |

*1. Enter the desired color symbol for the Pushbutton in the □.
*2. Black ("B") Pushbuttons are only available for non-lighted models.

Individual models: Refer to pages 9 to 13.
(The Pushbutton, Lamp, Case, and Switch can be ordered separately.)

■ Ratings: Refer to page 16. ■ Characteristics: Refer to page 16.
■ Accessories: Refer to page 15.

Ordering Information

Ordering as a Set..... The model numbers used to order sets of Units are given in the following tables. One set comprises the Pushbutton, Lamp (lighted models only), Case, and Switch.

Models with Reduced-voltage Lighting and Solder Terminals



A16□-T1

Note: Models with voltage ratings of 200 to 220 VAC/DC (T2 models) are listed with models with screw-less clamp

IP40

| Output | Lighting | Item Operating voltage | Momentary operation (Self-resetting) | Alternate operation (Self-holding) | Pushbutton color symbol * |
|--------|---|---------------------------|---|---------------------------------------|---|
| SPDT | LED (with built-in reduced-voltage lighting function) | 100/110 VAC/VDC | A16L-Δ□M-T1-1 | A16L-Δ□A-T1-1 | R: red, Y: yellow PY: pure yellow G: green, W: white A: blue PW: pure white |
| DPDT | | 100/110 VAC/VDC | A16L-Δ□M-T1-2 | A16L-Δ□A-T1-2 | |

* Enter the desired shape for the Pushbutton in Δ: J (rectangular), A (square), or T (round). Enter the desired color symbol for the Pushbutton in the □.

Oil-resistant IP65

| Output | Lighting | Item Operating voltage | Momentary operation (Self-resetting) | Alternate operation (Self-holding) | Pushbutton color symbol * |
|--------|---|---------------------------|---|---------------------------------------|---|
| SPDT | LED (with built-in reduced-voltage lighting function) | 100/110 VAC/VDC | A165L-Δ□M-T1-1 | A165L-Δ□A-T1-1 | R: red, Y: yellow PY: pure yellow G: green, W: white A: blue PW: pure white |
| DPDT | | 100/110 VAC/VDC | A165L-Δ□M-T1-2 | A165L-Δ□A-T1-2 | |

* Enter the desired shape for the Pushbutton in Δ: J (rectangular), A (square), or T (round). Enter the desired color symbol for the Pushbutton in the □.

Screw-less Clamp Models

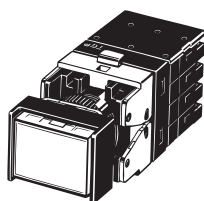

A16□-2S

IP40

| Output | Lighting | Item Operating voltage | Momentary operation (Self-resetting) | Alternate operation (Self-holding) | Pushbutton color symbol *1 |
|-------------|---|---------------------------|---|---------------------------------------|--|
| DPDT | LED | 5 VDC | A16L-Δ□M-5D-2S | A16L-Δ□A-5D-2S | R: red, Y: yellow PY: pure yellow G: green, W: white A: blue PW: pure white B: black *2 |
| | | 12 VAC/VDC | A16L-Δ□M-12D-2S | A16L-Δ□A-12D-2S | |
| | | 24 VAC/VDC | A16L-Δ□M-24D-2S | A16L-Δ□A-24D-2S | |
| | LED (with built-in reduced-voltage lighting function) | 100/110 VAC/VDC | A16L-Δ□M-T1-2S | A16L-Δ□A-T1-2S | |
| | | 200/220 VAC/VDC | A16L-Δ□M-T2-2S | A16L-Δ□A-T2-2S | |
| Non-lighted | | A16-Δ□M-2S | A16-Δ□A-2S | | |

*1. Enter the desired shape for the Pushbutton in Δ: J (rectangular), A (square), or T (round). Enter the desired color symbol for the Pushbutton in the □.

*2. Black ("B") Pushbuttons are only available for non-lighted models.

Oil-resistant IP65

| Output | Lighting | Item Operating voltage | Momentary operation (Self-resetting) | Alternate operation (Self-holding) | Pushbutton color symbol *1 |
|-------------|---|---------------------------|---|---------------------------------------|--|
| DPDT | LED | 5 VDC | A165L-Δ□M-5D-2S | A165L-Δ□A-5D-2S | R: red, Y: yellow PY: pure yellow G: green, W: white A: blue PW: pure white B: black *2 |
| | | 12 VAC/VDC | A165L-Δ□M-12D-2S | A165L-Δ□A-12D-2S | |
| | | 24 VAC/VDC | A165L-Δ□M-24D-2S | A165L-Δ□A-24D-2S | |
| | LED (with built-in reduced-voltage lighting function) | 100/110 VAC/VDC | A165L-Δ□M-T1-2S | A165L-Δ□A-T1-2S | |
| | | 200/220 VAC/VDC | A165L-Δ□M-T2-2S | A165L-Δ□A-T2-2S | |
| Non-lighted | | A165-Δ□M-2S | A165-Δ□A-2S | | |

*1. Enter the desired shape for the Pushbutton in Δ: J (rectangular), A (square), or T (round). Enter the desired color symbol for the Pushbutton in the □.

*2. Black ("B") Pushbuttons are only available for non-lighted models.

Ordering Information

Ordering as a Set The model numbers used to order sets of Units are given in the following tables. One set comprises the Pushbutton, Lamp (lighted models only), Case, and Switch.

Models with PCB Terminals



IP40

| Output | Lighting | Operating voltage | Item | Momentary operation (Self-resetting) | Pushbutton color symbol *1 |
|--------|-------------|-------------------|------|--------------------------------------|--|
| SPDT | LED | 5 VDC | | A16L-Δ□M-5D-1P | R: red Y: yellow PY: pure yellow G: green A: blue W: white B: black *2 |
| | | 12 VAC/VDC | | A16L-Δ□M-12D-1P | |
| | | 24 VAC/VDC | | A16L-Δ□M-24D-1P | |
| | Non-lighted | | | A16-Δ□M-1P | |
| DPDT | LED | 5 VDC | | A16L-Δ□M-5D-2P | |
| | | 12 VAC/VDC | | A16L-Δ□M-12D-2P | |
| | | 24 VAC/VDC | | A16L-Δ□M-24D-2P | |
| | Non-lighted | | | A16-Δ□M-2P | |

Note: Contact your OMRON representative about Selector Switches and Key Selector Switches.

*1. Enter the desired shape for the Pushbutton in Δ: J (rectangular), A (square), or T (round). Enter the desired color symbol for the Pushbutton in the □.

*2. Black ("B") Pushbuttons are only available for non-lighted models.

IP65

| Output | Lighting | Operating voltage | Item | Momentary operation (Self-resetting) | Pushbutton color symbol *1 |
|--------|-------------|-------------------|------|--------------------------------------|--|
| SPDT | LED | 5 VDC | | A165L-Δ□M-5D-1P | R: red Y: yellow PY: pure yellow G: green A: blue W: white B: black *2 |
| | | 12 VAC/VDC | | A165L-Δ□M-12D-1P | |
| | | 24 VAC/VDC | | A165L-Δ□M-24D-1P | |
| | Non-lighted | | | A165-Δ□M-1P | |
| DPDT | LED | 5 VDC | | A165L-Δ□M-5D-2P | |
| | | 12 VAC/VDC | | A165L-Δ□M-12D-2P | |
| | | 24 VAC/VDC | | A165L-Δ□M-24D-2P | |
| | Non-lighted | | | A165-Δ□M-2P | |

Note: Contact your OMRON representative about Selector Switches and Key Selector Switches.

*1. Enter the desired shape for the Pushbutton in Δ: J (rectangular), A (square), or T (round). Enter the desired color symbol for the Pushbutton in the □.

*2. Black ("B") Pushbuttons are only available for non-lighted models.

Ordering Information

Illumination Only and Colored Illumination for Models with LEDs

With illumination only, the color of the lighted surface is the same when the LED is lit and when it is not lit.

Example: Red Illumination

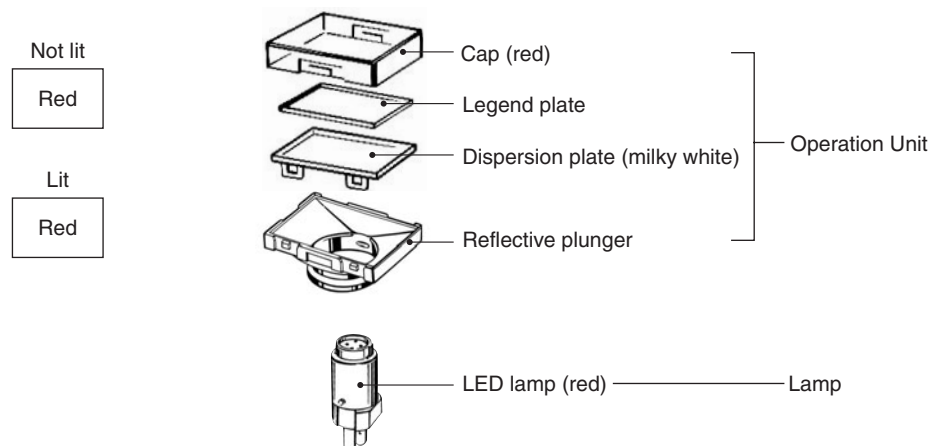

With colored illumination, the color of the lighted surface is white when the LED is not lit and the LED emits another color when it is lit.

Example: Red Illumination

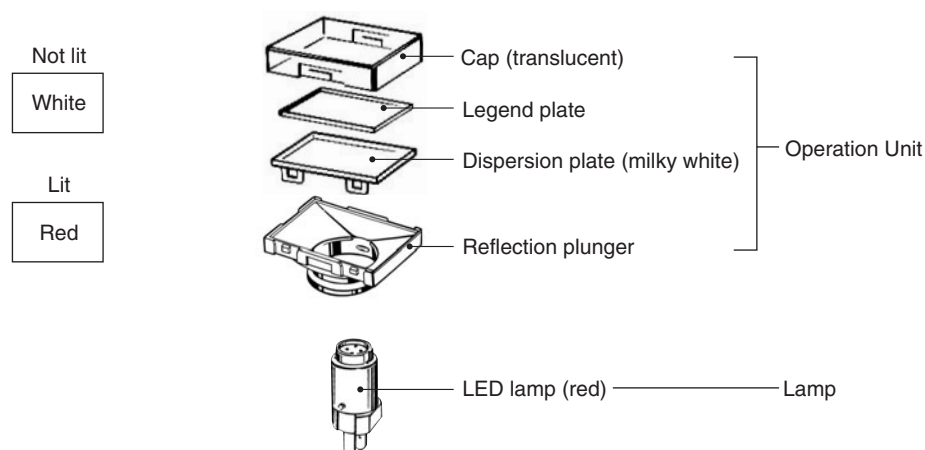

Ordering: For colored illumination, order the Operation Unit, Case, Lamp, and Socket Unit separately.

| Color emitted when lit | Operation Unit | Case | Lamp (LED) | | Socket Unit |
|------------------------|---|---|-----------------|--|--|
| Red | IP40 A16L-□W | IP40 • Momentary: A16-C□M • Alternate: A16-C□A | A16-□DSR | Specify one of the following symbols in the box (□). 5: 5 VDC 12: 12 VAC/VDC 24: 24 VAC/VDC | Refer to page 14. Any Switch can be mounted. |
| Yellow | IP65 A165L-□W Insert one of the following symbols into the box (□). J: Rectangular | IP65 • Momentary: A165-C□M • Alternate: A165-C□A | A16-□DSY | | |
| Green | A: Square | Insert one of the following symbols into the box (□). J: Rectangular (2-way guard) | A16-□DSG | | |
| Blue | T: Round | A: Square (2-way guard) T: Round (projected) | A16-□DA | | |

Ordering Information

Ordering Individually Pushbuttons, Lamps, Cases, and Switches (Sockets) can be ordered separately. Combinations that are not available as sets can be created using individual Units. Also, store the parts as spares for maintenance and repairs.



Note: Use IP40 Operation Units with IP40 Socket Units and use IP65 Operation Units with IP65 Socket Units. There is no Legend Plate built into the Operation Unit.



Ordering set combinations: Refer to pages 3 to 7.

- Specifications: Refer to page 16.
- Accessories, Replacement, and Tools: Refer to page 15.

Ordering Information

Units Select an Operation Unit Set (Operation Unit and Case) and a Socket Unit Set (Lamp and Socket Unit).

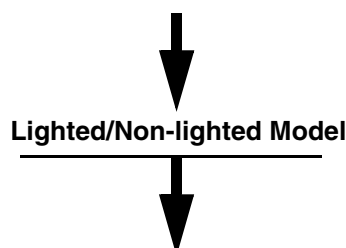
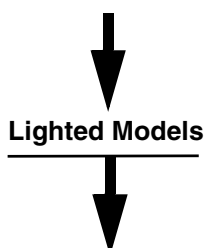

Unit Sets Sets that combine an Operation Unit and a Case.

Operation Unit

| Appearance | Classification | | | Model |
|---|--------------------|---------------------|---------------------------|-----------------|
|  | IP40 | Momentary operation | Rectangular (2-way guard) | A16-J□M |
| | | | Square (2-way guard) | A16-A□M |
| | | | Round (projected) | A16-T□M |
| | | Alternate operation | Rectangular (2-way guard) | A16-J□A |
| | | | Square (2-way guard) | A16-A□A |
| | | | Round (projected) | A16-T□A |
| | Oil-resistant IP65 | Momentary operation | Rectangular (2-way guard) | A165-J□M |
| | | | Square (2-way guard) | A165-A□M |
| | | | Round (projected) | A165-T□M |
| | | Alternate operation | Rectangular (2-way guard) | A165-J□A |
| | | | Square (2-way guard) | A165-A□A |
| | | | Round (projected) | A165-T□A |

Insert one of the following symbols into the box (□).

| Symbol | Color | Remarks |
|--------|-------------|--|
| R | Red | LED indicator, incandescent lamp, or non-lighted |
| Y | Yellow | |
| PY | Pure yellow | |
| A | Blue | |
| W | White* | |
| GY | Green | LED only |
| G | Green | Incandescent lamp or non-lighted |
| B | Black | Non-lighted only |

* Use this pushbutton color if the illumination color of the LED is white or pure white.

Ordering Information

Unit Sets Sets that combine a Socket Unit and a Lamp.

Socket Unit Sets with Incandescent Lamps

| Appearance | Classification | | Model |
|---|-------------------------------|------------------|----------------------|
|  | Standard loads and microloads | Solder terminals | SPDT A16L-□-1 |
| | | | DPDT A16L-□-2 |

Socket Unit Sets with LED Lamps

| Appearance | Classification | | Model |
|---|-------------------------------|------------------|-------------------------|
|  | Standard loads and microloads | Solder terminals | SPDT A16L-Δ-□-1 |
| | | | DPDT A16L-Δ-□-2 |
| | | PCB terminals | SPDT A16L-Δ-□-1P |
| | | | DPDT A16L-Δ-□-2P |

Socket Unit Set with Voltage-reduction Lighting (Soldered Terminals)

| Appearance | Classification | Operating voltage | Model |
|---|-------------------------------|----------------------|---------------------|
|  | Standard loads and microloads | SPDT 100/110 VAC/VDC | A16L- Δ-T1-1 |
| | | DPDT 100/110 VAC/VDC | A16L-Δ-T1-2 |

Note: An LED rated 24 VAC/VDC is built-in.

Screw-less Clamp Socket Unit Sets

| Appearance | Classification | | | Model | |
|---|-------------------------------|------|-------------------------------------|--------------------|---------------------|
|  | Standard loads and microloads | DPDT | Non-lighted | A16-2S | |
| | | | No voltage-reduction lighting | A16L-Δ-□-2S | |
| | | | Voltage-reduction lighting Note. | 100/110 VAC/VDC | A16L-Δ-T1-2S |
| | | | | 200/220 VAC/VDC | A16L-Δ-T2-2S |

Note: The 100-V models and 200-V models an LED rated 24 VAC/VDC is built-in.

Insert symbols in Δ and □.

Δ

| Symbol | Color |
|--------|--------|
| R | Red |
| Y | Yellow |
| G | Green |
| W | White |
| A | Blue |

□

| Symbol | Type | Operating voltage |
|--------|--------------|-------------------|
| 5 | Incandescent | 5 VAC/VDC |
| 12 | | 12 VAC/VDC |
| 24 | | 24 VAC/VDC |
| 5D | LED | 5 VDC |
| 12D | | 12 VAC/VDC |
| 24D | | 24 VAC/VDC |

Note: If the Operation Unit is pure yellow (PY), use white (W) for the Socket Unit Set.

Ordering Information

Ordering Individually Pushbuttons, Lamps, Cases, and Switches (Sockets) can be ordered separately. Combinations that are not available as sets can be created using individual Units. Also, store the parts as spares for maintenance and repairs.

Pushbuttons LED

| Degree of protection | IP40 | | | Oil-resistant IP65 | | |
|----------------------|--|---|--|---|---|--|
| | Rectangular  | Square  | Round  | Rectangular  | Square  | Round  |
| Color | | | | | | |
| Red | A16L-JR | A16L-AR | A16L-TR | A165L-JR | A165L-AR | A165L-TR |
| Yellow | A16L-JY | A16L-AY | A16L-TY | A165L-JY | A165L-AY | A165L-TY |
| Pure yellow | A16L-JPY | A16L-APY | A16L-TPY | A165L-JPY | A165L-APY | A165L-TPY |
| Green | A16L-JGY | A16L-AGY | A16L-TGY | A165L-JGY | A165L-AGY | A165L-TGY |
| White* | A16L-JW | A16L-AW | A16L-TW | A165L-JW | A165L-AW | A165L-TW |
| Blue | A16L-JA | A16L-AA | A16L-TA | A165L-JA | A165L-AA | A165L-TA |

* Use this pushbutton color if the illumination color of the LED is white or pure white.

Incandescent Lamps (With the exception of green, the Units are the same as for LEDs.)

| Degree of protection | IP40 | | | Oil-resistant IP65 | | |
|----------------------|--|---|--|---|---|--|
| | Rectangular  | Square  | Round  | Rectangular  | Square  | Round  |
| Color | | | | | | |
| Red | A16L-JR | A16L-AR | A16L-TR | A165L-JR | A165L-AR | A165L-TR |
| Yellow | A16L-JY | A16L-AY | A16L-TY | A165L-JY | A165L-AY | A165L-TY |
| Pure yellow | A16L-JPY | A16L-APY | A16L-TPY | A165L-JPY | A165L-APY | A165L-TPY |
| Green | A16L-JG | A16L-AG | A16L-TG | A165L-JG | A165L-AG | A165L-TG |
| White | A16L-JW | A16L-AW | A16L-TW | A165L-JW | A165L-AW | A165L-TW |
| Blue | A16L-JA | A16L-AA | A16L-TA | A165L-JA | A165L-AA | A165L-TA |

Non-lighted (Same as Units for incandescent lamps.)

| Degree of protection | IP40 | | | Oil-resistant IP65 | | |
|----------------------|--|---|--|---|---|--|
| | Rectangular  | Square  | Round  | Rectangular  | Square  | Round  |
| Color | | | | | | |
| Red | A16L-JR | A16L-AR | A16L-TR | A165L-JR | A165L-AR | A165L-TR |
| Yellow | A16L-JY | A16L-AY | A16L-TY | A165L-JY | A165L-AY | A165L-TY |
| Pure yellow | A16L-JPY | A16L-APY | A16L-TPY | A165L-JPY | A165L-APY | A165L-TPY |
| Green | A16L-JG | A16L-AG | A16L-TG | A165L-JG | A165L-AG | A165L-TG |
| White | A16L-JW | A16L-AW | A16L-TW | A165L-JW | A165L-AW | A165L-TW |
| Blue | A16L-JA | A16L-AA | A16L-TA | A165L-JA | A165L-AA | A165L-TA |
| Black | A16L-JB | A16L-AB | A16L-TB | A165L-JB | A165L-AB | A165L-TB |

Ordering set combinations: Refer to pages 3 to 7.

- Specifications: Refer to page 16.
- Accessories, Replacement, and Tools: Refer to page 15.

Ordering Information

Ordering Individually Pushbuttons, Lamps, Cases, and Switches (Sockets) can be ordered separately. Combinations that are not available as sets can be created using individual Units. Also, store the parts as spares for maintenance and repairs.

Lamps LED

| Light color | High brightness  | | |
|-------------|---|------------|------------|
| | 5 VDC | 12 VAC/VDC | 24 VAC/VDC |
| Red | A16-5DSR | A16-12DSR | A16-24DSR |
| Yellow | A16-5DSY | A16-12DSY | A16-24DSY |
| Green | A16-5DSG | A16-12DSG | A16-24DSG |
| White * | A16-5DSW | A16-12DSW | A16-24DSW |
| Blue | A16-5DA | A16-12DA | A16-24DA |
| Pure white | A16-5DPW | A16-12DPW | A16-24DPW |

Note: 1. If an LED lamp with normal brightness is needed, select a Lamp used in the A3C.
 2. For voltage-reduction lighting use the A16-24D□. Only 24 VAC/VDC LED lamps can be used.
 * Use the white LED together with white or pure yellow Pushbuttons.

Incandescent Lamp

| Appearance | Operating voltage | Model |
|---|-------------------|--------|
|  | 5 VAC/VDC | A16-5 |
| | 12 VAC/VDC | A16-12 |
| | 24 VAC/VDC | A16-24 |

Cases

| Appearance | Classification | | Model | |
|---|--------------------|---------------------|---------------------------|----------|
|  | IP40 | Momentary operation | Rectangular (2-way guard) | A16-CJM |
| | | | Square (2-way guard) | A16-CAM |
| | | | Round (projected) | A16-CTM |
| | | Alternate operation | Rectangular (2-way guard) | A16-CJA |
| | | | Square (2-way guard) | A16-CAA |
| | | | Round (projected) | A16-CTA |
| | Oil-resistant IP65 | Momentary operation | Rectangular (2-way guard) | A165-CJM |
| | | | Square (2-way guard) | A165-CAM |
| | | | Round (projected) | A165-CTM |
| | | Alternate operation | Rectangular (2-way guard) | A165-CJA |
| | | | Square (2-way guard) | A165-CAA |
| | | | Round (projected) | A165-CTA |

Ordering set combinations: Refer to pages 3 to 7.

- Specifications: Refer to page 16.
- Accessories, Replacement, and Tools: Refer to page 15.

Ordering Information

Switches

| Appearance | Classification | | | Model |
|---|----------------------------------|---|------|---------------|
| Solder terminal  | Lighted/non-lighted (common use) | Standard load/microload (common use) | SPDT | A16-1 |
| PCB terminal  | | | DPDT | A16-2 |
| | | | SPDT | A16-1P |
| Screw-less Clamp  | | | DPDT | A16-2P |
| | | | DPDT | A16-2S |

Switches with Reduced-voltage Lighting

| Appearance | Classification | | | Model |
|---|----------------|---|------|------------------|
| Solder terminal  | 100 V | Standard load/microload (common use) | SPDT | A16-T1-1 |
| Screw-less Clamp  | | | DPDT | A16-T1-2 |
| | 100 V | | DPDT | A16-T1-2S |
| | | | | 200 V |

Note: For voltage-reduction use the A16-24D□. Only 24 VAC/VDC LED lamps can be used.

Ordering Information

Accessories, Replacements, and Tools

Accessories

| Name | Appearance | Classification | Model | Remarks |
|---------------|---|-----------------------------|-------------------|---|
| Switch Guards |  | For rectangular models | A16ZJ-5050 | Cannot be used with the Dust Cover. |
| | | For square and round models | A16ZA-5050 | |
| Dust Covers |  | For rectangular models | A16ZJ-5060 | Cannot be used with the Switch Guard. Can be operated with the Dust Cover attached. |
| | | For square models | A16ZA-5060 | |
| | | For round models | A16ZT-5060 | |
| Panel Plugs |  | For rectangular models | A16ZJ-3003 | Used for covering the panel cutouts for future panel expansion. Protective structure: IP40 Color: Black |
| | | For square models | A16ZA-3003 | |
| | | For round models | A16ZT-3003 | |

Replacements

| Name | Appearance | Classification | | | Model | Remarks | |
|-------------------------------------|---|---------------------------------------|--------------------|-------------------------------|---------------------|--|--------------------|
| Legend Plates |  | Rectangular | Oil-resistant IP65 | Milky | A16ZJ-5204 | <ul style="list-style-type: none"> A single Legend Plate (Milky white) is included with a standard model. The milky Legend Plate can be used with the IP40 and oil-resistant IP65. | |
| | | Square | Oil-resistant IP65 | Milky | A16ZA-5204 | | |
| | | Round | Oil-resistant IP65 | Milky | A16ZT-5204 | | |
| Color Caps (for IP40) |  | LED lamp/incandescent lamp/nonlighted | | White | A16Z□-5001W | <ul style="list-style-type: none"> Insert one of the following letters into the box (□). J: Rectangular A: Square T: Round The Color Cap is usually supplied. Replace the Cap if the color is to be changed. When using an LED indicator, be sure to use a Color Cap that matches the luminescent color of the LED. The materials used for the IP40 and oil-resistant IP65 are different so be sure to use a Color Cap that matches the specifications of the Switch. | |
| | | | | Red | A16Z□-5001R | | |
| | | | | Yellow | A16Z□-5001Y | | |
| | | | | Pure yellow | A16Z□-5001PY | | |
| | | | | Blue | A16Z□-5001A | | |
| Color Caps (for oil-resistant IP65) |  | LED lamp | | Green | A16Z□-5001GY | | |
| | | | | Incandescent lamp/non-lighted | Green | | A16Z□-5001G |
| | | | | | Non-lighted | | Black |
| Color Caps (for IP65) |  | LED lamp/incandescent lamp/nonlighted | | White | A16Z□-5101W | | |
| | | | | Red | A16Z□-5101R | | |
| | | | | Yellow | A16Z□-5101Y | | |
| | | | | Pure yellow | A16Z□-5101PY | | |
| | | | | Blue | A16Z□-5101A | | |
| Color Caps (for IP65) |  | LED lamp | | Green | A16Z□-5101GY | | |
| | | | | Incandescent lamp/non-lighted | Green | A16Z□-5101G | |
| | | | | | Non-lighted | Black | A16Z□-5111B |

Tools

| Name | Appearance | Model | Applicable types | | | | | Remarks |
|----------------------------|---|------------------|-------------------|---------------------------|--------------------------|-----------------------|-----------|---|
| | | | Pushbutton Switch | Knob-type Selector Switch | Key-type Selector Switch | Emergency Stop Switch | Indicator | |
| Operation Unit Extractor |  | A3PJ-5080 | ● | — | — | — | ● | Convenient for extracting Pushbutton Switches |
| Screw Fitting |  | A16Z-3004 | ● | ● | ● | ● | ● | Convenient for ganged installation. |
| Socket Unit Lamp Extractor |  | A16Z-5080 | ● | ● | ● | ● | ● | Convenient for extracting the Switch and Lamps. |

Specifications

Approved Standard Ratings

UL, cUL (File No. E41515)

5 A at 125 VAC, 3 A at 250 VAC (general use)
3 A at 30 VDC (resistive)

Note: Certification has been obtained for the Socket Unit.
For detailed information on individual products that have received certification, consult your supplier.

TÜV (EN60947-5-1) (Low Voltage Directive)

3 A at 250 VAC
3 A at 30 VDC

CCC (GB14048.5)

5 A at 125 VAC
3 A at 250 VAC
3 A at 30 VDC

Ratings

Contacts

| Rated voltage | Resistive load |
|---------------|----------------|
| 125 VAC | 5 A |
| 250 VAC | 3 A |
| 30 VDC | 3 A |

Minimum applicable load: 1 mA at 5 VDC

Rated values are obtained from tests conducted under the following conditions.

1. Load: Resistive load
2. Mounting conditions: No vibration and no shock
3. Temperature: 20 ±2°C
4. Operating frequency: 20 operations/min

Contact Form

| Name | Contact |
|------|---------|
| DPDT | |

Characteristics

Socket Unit

| Item | Type | Pushbutton Switch |
|---------------------------------|---|--|
| Allowable operating frequency | Mechanical | Momentary operation: 120 operations/minute max. Alternate operation: 60 operations/minute max. *1 |
| | Electrical | 20 operations/minute max. *1 |
| Insulation resistance | | 100 MΩ min. (at 500 VDC) |
| Dielectric strength | Between terminals of same polarity | 1,000 VAC, 50/60 Hz for 1 minute |
| | Between terminals of different polarity | 2,000 VAC, 50/60 Hz for 1 minute |
| | Between each terminal and ground | 2,000 VAC, 50/60 Hz for 1 minute |
| | Between lamp terminals | 1,000 VAC, 50/60 Hz for 1 minute *2 |
| Vibration resistance | Malfunction | 10 to 55 Hz, 1.5-mm double amplitude (malfunction within 1 ms) |
| Shock resistance | Destruction | 500 m/s ² |
| | Malfunction | 150 m/s ² max. (malfunction within 1 ms) |
| Durability | Mechanical | Momentary operation: 2,000,000 operations min. Alternate operation: 200,000 operations min. *1 |
| | Electrical | 100,000 operations min. *1 |
| Electric shock protection class | | Class II |
| PTI (tracking characteristic) | | 175 |
| Degree of contamination | | 3 (IEC947-5-1) |
| Weight | | Approx. 10 g (in the case of a lighted DPDT switch with solder terminals) |
| Degree of protection | | IP40: A16, Oil-resistant IP65: A165 *3 |
| Ambient operating temperature | | -10°C to 55°C (with no icing or condensation) |
| Ambient operating humidity | | 35% to 85%RH |
| Ambient storage temperature | | -25°C to 65°C (with no icing or condensation) |

*1. Set and reset constitute one operation.

*2. With LED and incandescent lamp not mounted.

*3. Degree of protection from the front of the panel.

Super-bright LED

| Rated voltage | Rated current | Operating voltage | Internal limiting resistor |
|---------------|---------------|-------------------|---|
| 5 VDC | 8 mA | 5 VDC ±5% | Red, yellow, white: 300 Ω Green, blue, pure white: 160 Ω |
| 12 VAC/VDC | | 12 VAC/VDC ±5% | Red, yellow, white: 1 kΩ Green, blue, pure white: 910 Ω |
| 24 VAC/VDC | | 24 VAC/VDC ±5% | 2.4 kΩ |

Incandescent Lamp

| Rated voltage | Rated current | Operating voltage |
|---------------|---------------|-------------------|
| 6 VAC/VDC | 60 mA | 5 VAC/VDC |
| 14 VAC/VDC | 40 mA | 12 VAC/VDC |
| 28 VAC/VDC | 24 mA | 24 VAC/VDC |

Voltage-reduction Unit (LED Lamp)

| Rated voltage | Operating voltage | Applicable lamp |
|---------------|--------------------------------|-----------------------|
| 110 VAC/VDC | 100/110 VAC/VDC (90 to 121 V) | A16-24DS□ LED Lamp |
| 220 VAC/VDC | 200/220 VAC/VDC (180 to 242 V) | |

Screw-less Clamp

| Item | Screw-Less Clamp | | | | |
|-----------------------------------|--|---------------------|---------------------|----------------------|----------------------|
| Recommended wire size | 0.5 mm ² twisted wire or 0.8 mm-dia. solid wire | | | | |
| Usable wires and tensile strength | Twisted wire | 0.3 mm ² | 0.5 mm ² | 0.75 mm ² | 1.25 mm ² |
| | Solid wire | 0.5 mm dia. | 0.8 mm dia. | 1.0 mm dia. | — |
| | Tensile strength | 10 N | 20 N | 30 N | 40 N |
| Length of exposed wire | 10 ±1mm | | | | |
| Compliant standards | JIS C 2811 Terminal Blocks for Industrial Use | | | | |

Operating Characteristics

| Characteristics | Type | Pushbutton Switch | |
|------------------------------------|------|-------------------|--------------------|
| | | IP40 | Oil-resistant IP65 |
| Operating force (OF) max. | | 4.41 N | 4.91 N |
| Releasing force (RF) min. | | 0.29 N | |
| Total travel (TT) | | Approx. 3 mm | |
| Pretravel (PT) max. | | 2.5 mm | |
| Lock travel alternate (LTA) min. * | | 0.5 mm | |

* Alternate operation models only.

Nomenclature

Model Structure

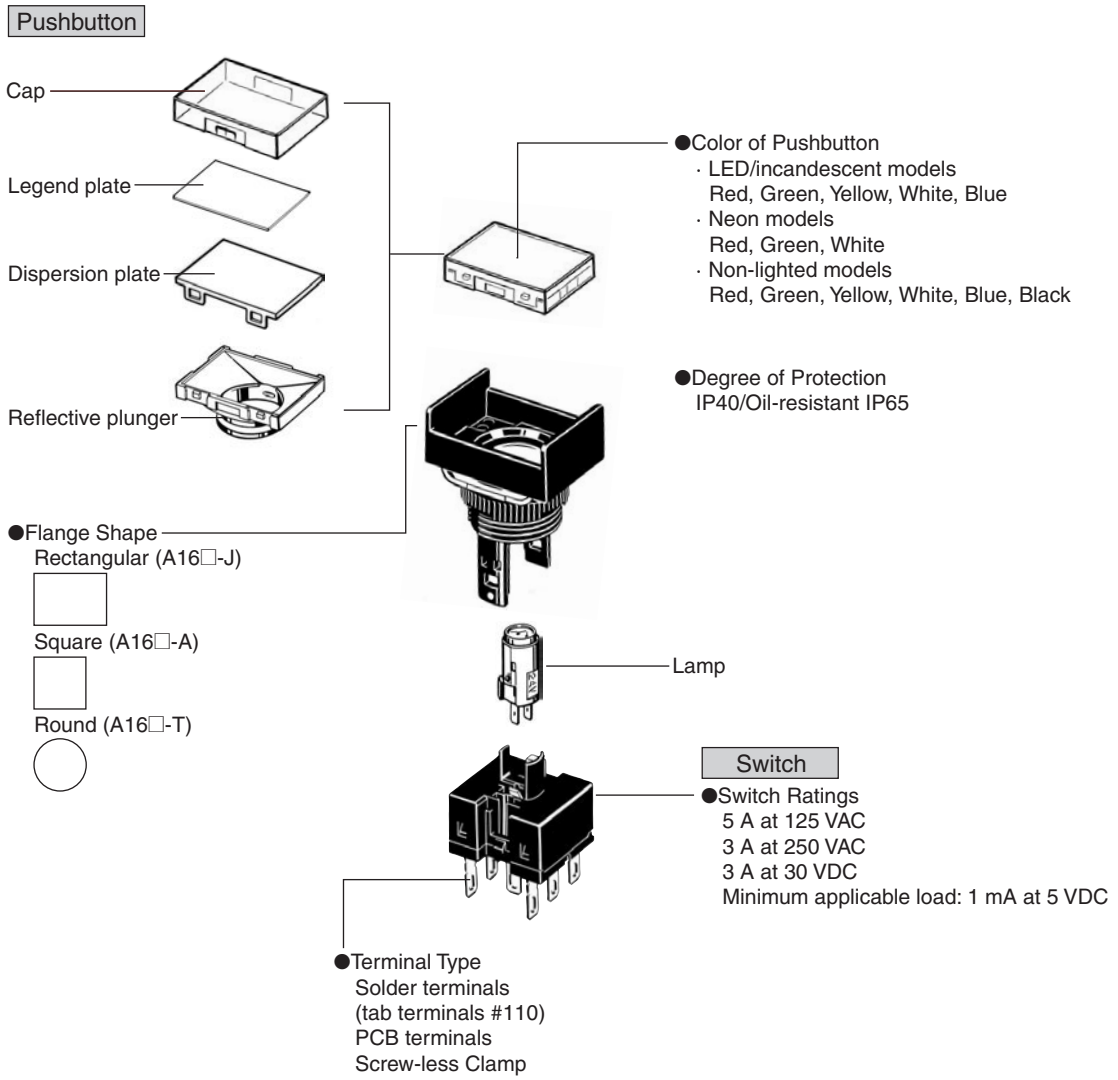

Dimensions

• The Dimension shows 2-switch outputs. • The lamp terminal is also provided with non-lighted models.

(Unit: mm)

Rectangular

A16□-J

Solder terminals (tab terminals #110)



• See page 21 for panel cutouts



Square

A16□-A

Solder terminals (tab terminals #110)



• See page 21 for panel cutouts



Round

A16□-T

Solder terminals (tab terminals #110)



• See page 21 for panel cutouts

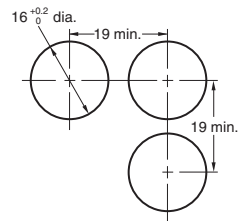

Dimensions

• The Dimension shows 2-switch outputs. • The lamp terminal is also provided with non-lighted models. • A rectangular model is listed as an example. (Unit: mm)

Rectangular A16□-J□-□P PCB terminals

• See page 21 for panel cutouts



Rectangular A16□-J□-T1 Voltage-reduction lighting, solder terminals (tab terminals #110)



Panel Cutouts



Rectangular A16□-J□-2S, T1-2S, T2-2S Screw-less Clamp

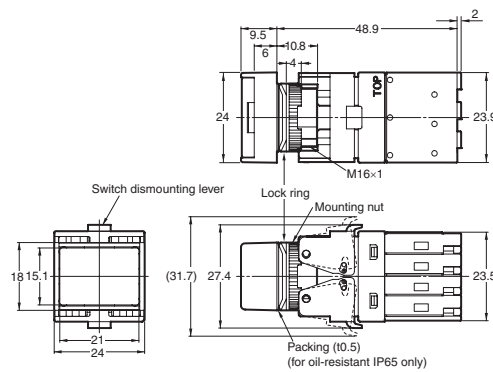
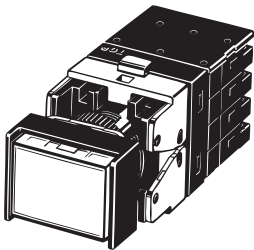

Panel Cutouts

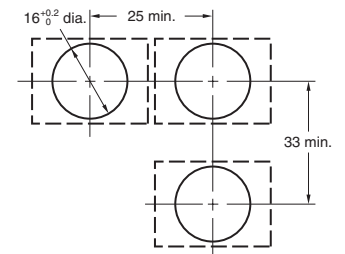

Lamps LED A16-5D□/-12D□/-24D□



Incandescent Lamp A16-5/-12/-24

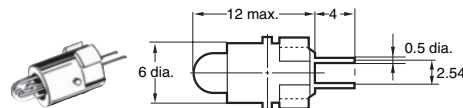

* The voltage display surface is the same color as the illumination color. The opposite surface is light gray. (For pure white, the entire surface is light gray.)

Dimensions

Accessories, Tools, and Components

Extractor A3PJ-5080



Legend Plates

A16ZJ-520□



A16ZA-520□



A16ZT-520□



Note: 1. The panel is 0.6 mm thick.
2. The panel is made of the materials listed in the following table.

| Color | Degree of protection | Materials |
|-------------|----------------------|---------------------|
| Milky | IP40 | Polyallylate resin |
| | IP65 | |
| Transparent | IP40 | Polycarbonate resin |
| | IP65 | Polyallylate resin |

Screw Fitting

A16Z-3004

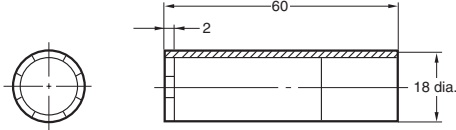

Panel Plugs (Black Resin)

Select the Plug that fits the panel design and mount from the front of the Panel. Panel cutouts are the same as those for Switches.

Protective structure: IP40
Color: Black

| Rectangular | Square | Round |
|-----------------------|-----------------------|-----------------------|
| A16ZJ-3003 | A16ZA-3003 | A16ZT-3003 |

Lock Ring



Socket Unit Lamp Extractor

A16Z-5080

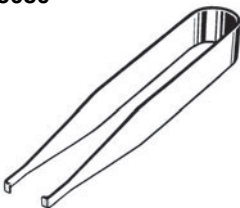

Dimensions

Panel Cutouts

Solder Terminals and Screw-less Clamp Connectors



Note: • Make sure the thickness of the mounting panel is between 0.5 and 3.2 mm. If, however, a Switch Guard or Dust Cover is used, the thickness of the mounting panel must be between 0.5 and 2 mm.
 • If the panel is to be finished with coating, etc., make sure that the panel meets the specified dimensions after coating.
 • Figures in parentheses are for Screw-less Clamp Connectors.

PCB Terminals



Note: • Ensure that the variation in the distance between the centers of neighboring mounting holes is less than ±0.1 mm.
 • Make sure the thickness of the mounting panel is between 0.5 and 3.2 mm. If, however, a Switch Guard or Dust Cover is used, the thickness of the mounting panel must be between 0.5 and 2 mm.
 • If the panel is to be finished with coating, etc., make sure that the panel meets the specified dimensions after coating.

Terminal Arrangement

Models without Reduced-voltage Lighting (Non-lighted Pushbutton Switches are also provided with lamp terminals.)

Solder Terminals



Dimensions

PCB Terminals (Lamp terminals are also present on non-lighted models.)



Terminal Arrangement

Voltage-reduction Lighting (Lamp terminals are also present on non-lighted models.)

Solder Terminals

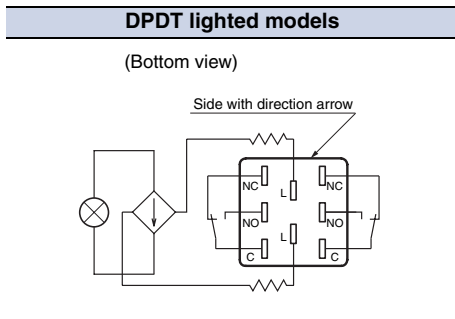

- The voltage-reduction circuit is built in.

Screw-Less Clamps

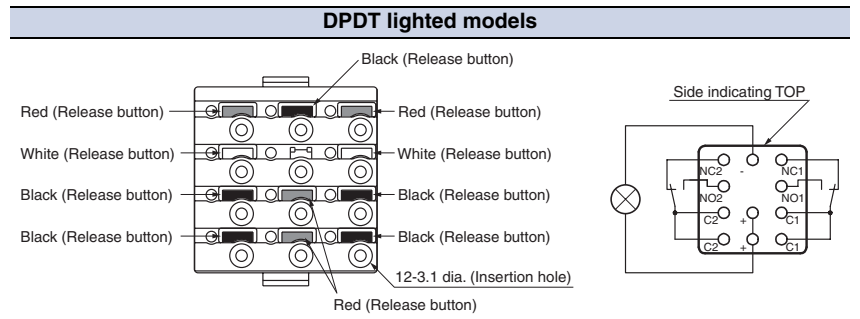

- Voltage-reduction lighting models with Screw-Less Clamps (A16L-□T1-2S, A16L-□T2-2S) incorporate voltage-reduction circuits.

Dimensions

Accessory Dimensions Mounted
Dimensions with Switch Guard Installed

Rectangular
A16ZJ-5050



Panel Cutout (Top View)

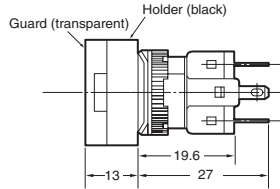

Note: This example is for when X is 4.5 mm.
If X is not required, the Switches can be mounted with a minimum vertical installation pitch of 24 mm min.

Square
A16ZA-5050



Panel Cutout (Top View)



Note: This example is for when X is 4.5 mm.
If X is not required, the Switches can be mounted with a minimum vertical installation pitch of 24 mm min.
If PCB terminals are used, provide X must be 24 mm or larger.

Dust Covers

Rectangular
A16ZJ-5060



Panel Cutouts



Square
A16ZA-5060



Panel Cutouts



Round
A16ZT-5060



Panel Cutouts



Safety Precautions

Refer to *Safety Precautions for All Pushbutton Switches*.

WARNING

Do not apply a voltage between the incandescent lamp and the terminal that is greater than the rated voltage. If the incandescent lamp is broken, the operating part may pop out.



Always turn OFF the power and wait for 10 minutes before replacing the incandescent lamp. If the lamp is replaced immediately after the power is turned OFF, the remaining heat may cause burns.



Precautions for Correct Use

Mounting

- Always make sure that the power is turned OFF before mounting, removing, or wiring the Switch, or performing maintenance.
- Do not tighten the mounting nut more than necessary using tools such as pointed-nose pliers. Doing so will damage the mounting nut.
The tightening torque is 0.29 to 0.49 N·m.

Wiring

- Solder terminals and quick-connect terminals (#110) are commonly used for terminals.
- Be sure to use electrical wires that are a size appropriate for the applied voltage and carry current (conductor size is 0.5 to 0.75 mm²). Perform soldering according to the conditions provided below. If the soldering is not properly performed, the lead wires will become detached, resulting in short-circuits.
 - Hand soldering: 350°C, within 3 s
 - Dip soldering: 350°C, within 3 s

Wait for one minute after soldering before exerting any external force on the solder.
- Use non-corrosive resin fluid as the flux.
- Make sure that the electric cord is wired so that it does not touch the Unit. If the electric cord touches the Unit, then electric wires with a heat resistance of 100°C min. must be used.
- After wiring the Switch, maintain an appropriate clearance and creepage distance.

Operating Environment

- This Switch is intended for indoor use only. Using the Switch outdoors will cause the Switch to fail. If IP40 models are used in locations subject to dust, metallic particles, or oil, be careful that none of these penetrates the Switch.
- The IP65 model is designed with a degree of protection so that it will not sustain damage if it is subjected to water from any direction to the front of the panel.
- Do not use the Switch submersed in oil or water, or in locations continuously subject to splashes of oil or water. Doing so may result in oil or water entering the Switch.

Using the Microload

- Insert a contact protection circuit, if necessary, to prevent the reduction of life expectancy due to extreme wear on the contacts caused by loads where inrush current occurs when the contact is opened and closed.
- The A16 allows both a standard load (125 V at 5A, 250 V at 3 A) and a microload. If a standard load is applied, however, the microload area cannot be used. If the microload area is used with a standard load, the contact surface will become rough, and the opening and closing of the contact for a microload may become unreliable.
- The minimum applicable load is the N-level reference value. This value indicates the malfunction reference level for the reliability level of 60% ($\lambda 60$) (conforming to JIS C5003).
The equation, $\lambda 60 = 0.5 \times 10^{-4}/\text{operations}$ indicates that the estimated malfunction rate is less than 1/2,000,000 operations with a reliability level of 60%.



LED

- The LED current-limiting resistor is built-in, so external resistance is not required.

| Rated voltage | Internal limiting resistor |
|---------------|---|
| 5 VDC | Red, yellow, white: 300 Ω Green, blue, pure white: 160 Ω |
| 12 VAC/VDC | Red, yellow, white: 1 kΩ Green, blue, pure white: 910 Ω |
| 24 VAC/VDC | 2.4 kΩ |

Others

- The oil-resistant IP65 uses NBR rubber and is resistant to general cutting oil and cooling oil. Some particular oils cannot be used with the oil-resistant IP65, however, so contact your OMRON representative for details.
- The durability of the Switch depends in the switching conditions. Always test the Switch under actual application conditions to confirm applicability and use the Switch only for the number of switching operations that will not affect performance. Continuing to use the Switch with degraded performance will eventually result insulation faults between circuits, burning of the Switch, or other failures.
- If the panel is to be finished with coating, etc., make sure that the panel meets the specified dimensions after the coating.
- Do not subject the Switch to extreme shock or vibration. Doing so will cause malfunctions and damage to the Switch.
- Do not let sharp objects come into contact with the Switches that are made of resin. Doing so will damage the Switches, causing scratches on the outside of the operating parts, and malfunction. When handling the Switches, do not throw or drop them.

- Rubber is used inside IP65 models. Do not allow the rubber to become scratched or foreign matter to become attached to the rubber. Scratches and foreign matter will degrade the waterproofing, and the Switch may fail operate correctly.



Screw-less Clamp Wiring Procedure

Connecting Wires

1. Strip the wires for 10 mm (allowable range: 10± 1 mm).
2. If braided wire is used, twist the wire to straighten it out.
3. Insert the wire into the insertion hole while pressing the release button at the side of the hole. (Using a precision screwdriver is recommended.)
4. Let go of the release button to lock the wire into place.
5. After locking, pull on the wire gently to confirm that it is securely locked.

Removing Wires

1. Remove wires by pulling them while pressing the release button.
- Note: When reusing wires that have already been locked one, cut off the end of the wire and strip the wire again before using.

Precautions

1. The mounting panel thickness must be 0.5 to 3.2 mm.
2. The mounting ring must be tightened to a torque 0.29 to 0.49 N-m.
3. The procedure for making the mounting hole for the screw-less clamp connector is described on page 21. A mounting dimension of at least 33 mm is required, however, because the Switch is removed with the screw-less clamp connector mounted to the panel. If Switches are mounted side-by-side separated by less than the specified distance, it may not be possible to remove the Switch.
4. Be sure to mount the Case to the Switch with the correct orientation. Mount with the dimple on the Case facing in the same direction as the side of the Switch with the direction arrow or the word TOP.



5. Bend the end of the wire if braided wire is used with the screw-less clamp connector.
6. When wiring, insert the wire until it comes into contact with something. After wiring is completed, pull on the wires to confirm that they are connected securely.
7. After wiring, ensure that continuous pressure is not applied to the terminals.
8. Refer to internal connection diagrams and confirm the terminal numbers before wiring.

Panel Mounting

After mounting the Pushbutton Unit (i.e., the Pushbutton and the Case) to the panel, snap in the Switch Unit (i.e., the Switch and the Lamp) from the back of the panel.

Mounting to the Panel

- Insert the Pushbutton Unit into the front of the panel, and fix the lock ring and mounting nut from the terminal side.
- Make sure that the lock ring is aligned with the thread of the Case and the edge of the lock ring is touching the panel.
- Tighten the mounting nuts to a torque of 0.29 to 0.49 N·m.



Mounting the Switch Unit

- Snap on the Switch Unit to the Pushbutton Unit.
- Make sure that the Switch Unit has the correct orientation when snapping it onto the Case. Align the dimple on the Case with the groove between the case guards on the NC terminal side of the Switch Unit in the way shown below, and push the Switch Unit into the Case until it clicks into place. Confirm that the Switch Unit is securely in place before using.



Removing the Switch Unit

- Grip the part between the Switch holder of the Case and the Switch Unit using the A16Z-5080 Extractor, and pull to remove the Switch Unit.



Note: Refer to page 21 for PCB terminals.

Engraving

Engraving the Legend Plate

- The characters must not be engraved deeper than 0.4 mm.
- Apply an alcohol-based paint coating, such as melamine, phthalate, or acrylic resin paint coating.

Mounting and Replacing the Pushbutton

Removing and Mounting the Pushbutton

- (1) Remove the Pushbutton as shown in the following diagram. If the Pushbutton cannot be removed by hand, use the A3PJ-5080 Extractor.



- (2) When mounting the Operation Unit to the Case, press the entire surface of the Operation Unit to surface A of the Case as shown in the following diagram.



Removing the Lamp

- (1) Removing from the Pushbutton End



- (2) Removing from the Switch End
The Lamp can be removed by hand once the Switch is removed using the A16Z-5080 Extractor.

Installing the Lamp

- When mounting the Lamp, make sure it is facing the direction shown in the following diagram. Insert the Lamp while matching the protruding part of the Lamp and the small guides on the outer surface of the Case.



- The Lamp can be mounted from the Pushbutton end by using the A16Z-5080 Extractor.
The lamp can be mounted by following the opposite procedure for removing the Lamp.

Mounting the A16Z Dust Cover



- Separate the Dust Cover into 2 parts: cover A and cover B.
 - Insert the Case (Pushbutton Unit) into cover A.
 - Mount these parts together onto the panel.
 - From the back of the panel, mount the lock ring and secure with the mounting nut.
 - Insert cover B into cover A. Ensure that the entire perimeter of cover B is securely attached to cover A by pressing in different directions.
 - Mount the Switch Unit to the Case.
- Note: Recommended panel thickness: 0.5 to 2 mm.

Mounting the A16Z Switch Guard



- Insert the Case (Pushbutton Unit) into the Switch Guard.
 - Mount these parts together onto the panel.
 - From the back of the panel, mount the lock ring and secure with the mounting nut.
 - Attach the Switch Unit to the Case.
- Note: Recommended panel thickness: 0.5 to 2 mm.

Read and Understand This Catalog

Please read and understand this catalog before purchasing the products. Please consult your OMRON representative if you have any questions or comments.

Warranty and Limitations of Liability

WARRANTY

OMRON's exclusive warranty is that the products are free from defects in materials and workmanship for a period of one year (or other period if specified) from date of sale by OMRON.

OMRON MAKES NO WARRANTY OR REPRESENTATION, EXPRESS OR IMPLIED, REGARDING NON-INFRINGEMENT, MERCHANTABILITY, OR FITNESS FOR PARTICULAR PURPOSE OF THE PRODUCTS. ANY BUYER OR USER ACKNOWLEDGES THAT THE BUYER OR USER ALONE HAS DETERMINED THAT THE PRODUCTS WILL SUITABLY MEET THE REQUIREMENTS OF THEIR INTENDED USE. OMRON DISCLAIMS ALL OTHER WARRANTIES, EXPRESS OR IMPLIED.

LIMITATIONS OF LIABILITY

OMRON SHALL NOT BE RESPONSIBLE FOR SPECIAL, INDIRECT, OR CONSEQUENTIAL DAMAGES, LOSS OF PROFITS OR COMMERCIAL LOSS IN ANY WAY CONNECTED WITH THE PRODUCTS, WHETHER SUCH CLAIM IS BASED ON CONTRACT, WARRANTY, NEGLIGENCE, OR STRICT LIABILITY.

In no event shall the responsibility of OMRON for any act exceed the individual price of the product on which liability is asserted.

IN NO EVENT SHALL OMRON BE RESPONSIBLE FOR WARRANTY, REPAIR, OR OTHER CLAIMS REGARDING THE PRODUCTS UNLESS OMRON'S ANALYSIS CONFIRMS THAT THE PRODUCTS WERE PROPERLY HANDLED, STORED, INSTALLED, AND MAINTAINED AND NOT SUBJECT TO CONTAMINATION, ABUSE, MISUSE, OR INAPPROPRIATE MODIFICATION OR REPAIR.

Application Considerations

SUITABILITY FOR USE

OMRON shall not be responsible for conformity with any standards, codes, or regulations that apply to the combination of products in the customer's application or use of the products.

At the customer's request, OMRON will provide applicable third party certification documents identifying ratings and limitations of use that apply to the products. This information by itself is not sufficient for a complete determination of the suitability of the products in combination with the end product, machine, system, or other application or use.

The following are some examples of applications for which particular attention must be given. This is not intended to be an exhaustive list of all possible uses of the products, nor is it intended to imply that the uses listed may be suitable for the products:

- Outdoor use, uses involving potential chemical contamination or electrical interference, or conditions or uses not described in this catalog.
- Nuclear energy control systems, combustion systems, railroad systems, aviation systems, medical equipment, amusement machines, vehicles, safety equipment, and installations subject to separate industry or government regulations.
- Systems, machines, and equipment that could present a risk to life or property.

Please know and observe all prohibitions of use applicable to the products.

NEVER USE THE PRODUCTS FOR AN APPLICATION INVOLVING SERIOUS RISK TO LIFE OR PROPERTY WITHOUT ENSURING THAT THE SYSTEM AS A WHOLE HAS BEEN DESIGNED TO ADDRESS THE RISKS, AND THAT THE OMRON PRODUCTS ARE PROPERLY RATED AND INSTALLED FOR THE INTENDED USE WITHIN THE OVERALL EQUIPMENT OR SYSTEM.

PROGRAMMABLE PRODUCTS

OMRON shall not be responsible for the user's programming of a programmable product, or any consequence thereof.

Disclaimers

CHANGE IN SPECIFICATIONS

Product specifications and accessories may be changed at any time based on improvements and other reasons.

It is our practice to change model numbers when published ratings or features are changed, or when significant construction changes are made. However, some specifications of the products may be changed without any notice. When in doubt, special model numbers may be assigned to fix or establish key specifications for your application on your request. Please consult with your OMRON representative at any time to confirm actual specifications of purchased products.

DIMENSIONS AND WEIGHTS

Dimensions and weights are nominal and are not to be used for manufacturing purposes, even when tolerances are shown.

PERFORMANCE DATA

Performance data given in this catalog is provided as a guide for the user in determining suitability and does not constitute a warranty. It may represent the result of OMRON's test conditions, and the users must correlate it to actual application requirements. Actual performance is subject to the OMRON Warranty and Limitations of Liability.

ERRORS AND OMISSIONS

The information in this document has been carefully checked and is believed to be accurate; however, no responsibility is assumed for clerical, typographical, or proofreading errors, or omissions.

2009.12

In the interest of product improvement, specifications are subject to change without notice.

OMRON Corporation
Industrial Automation Company

<http://www.ia.omron.com/>

(c)Copyright OMRON Corporation 2009 All Right Reserved.



Компания «ЭлектроПласт» предлагает заключение долгосрочных отношений при поставках импортных электронных компонентов на взаимовыгодных условиях!

Наши преимущества:

- Оперативные поставки широкого спектра электронных компонентов отечественного и импортного производства напрямую от производителей и с крупнейших мировых складов;
- Поставка более 17-ти миллионов наименований электронных компонентов;
- Поставка сложных, дефицитных, либо снятых с производства позиций;
- Оперативные сроки поставки под заказ (от 5 рабочих дней);
- Экспресс доставка в любую точку России;
- Техническая поддержка проекта, помощь в подборе аналогов, поставка прототипов;
- Система менеджмента качества сертифицирована по Международному стандарту ISO 9001;
- Лицензия ФСБ на осуществление работ с использованием сведений, составляющих государственную тайну;
- Поставка специализированных компонентов (Xilinx, Altera, Analog Devices, Intersil, Interpoint, Microsemi, Aeroflex, Peregrine, Syfer, Eurofarad, Texas Instrument, Miteq, Cobham, E2V, MA-COM, Hittite, Mini-Circuits, General Dynamics и др.);

Помимо этого, одним из направлений компании «ЭлектроПласт» является направление «Источники питания». Мы предлагаем Вам помощь Конструкторского отдела:

- Подбор оптимального решения, техническое обоснование при выборе компонента;
- Подбор аналогов;
- Консультации по применению компонента;
- Поставка образцов и прототипов;
- Техническая поддержка проекта;
- Защита от снятия компонента с производства.



Как с нами связаться

Телефон: 8 (812) 309 58 32 (многоканальный)

Факс: 8 (812) 320-02-42

Электронная почта: org@eplast1.ru

Адрес: 198099, г. Санкт-Петербург, ул. Калинина, дом 2, корпус 4, литера А.