

Evaluating the AD7175-2 24-Bit, 250 kSPS, Sigma-Delta ADC with 20 μ s Settling and Integrated Analog Input Buffers

FEATURES

Full featured evaluation board for the [AD7175-2](#)
 PC control in conjunction with the Analog Devices, Inc.,
[EVAL-SDP-CB1Z](#) system demonstration platform (SDP)
 PC software for control and data analysis (time domain)
 Standalone capability

EVALUATION KIT CONTENTS

[EVAL-AD7175-2SDZ](#) evaluation board
 AD717x Eval+ software CD
 7 V to 9 V ac-to-dc adapter
 Plastic screw washer set

EQUIPMENT NEEDED

DC signal source
 PC running Windows® XP to Windows 10

GENERAL DESCRIPTION

The [EVAL-AD7175-2SDZ](#) evaluation kit features the [AD7175-2](#), a 24-bit, 250 kSPS analog-to-digital converter (ADC) with integrated rail-to-rail-analog input buffers, on-board power supply regulation, and an external amplifier section for amplifier evaluation. A 7 V to 9 V ac-to-dc adapter is regulated to 5 V and 3.3 V, which supply the [AD7175-2](#) and support components. The [EVAL-AD7175-2SDZ](#) evaluation board connects to the USB port of a PC via the [EVAL-SDP-CB1Z](#) (SDP-B) controller board.

The AD717x Eval+ software fully configures the [AD7175-2](#) device functionality via an interactive block diagram and a user accessible register interface and provides dc time domain analysis in the form of waveform graphs, histograms, and associated noise analysis for ADC performance evaluation.

Full specifications for the [AD7175-2](#) are available in the product data sheet, which should be consulted in conjunction with this user guide when using the evaluation board.

FUNCTIONAL BLOCK DIAGRAM

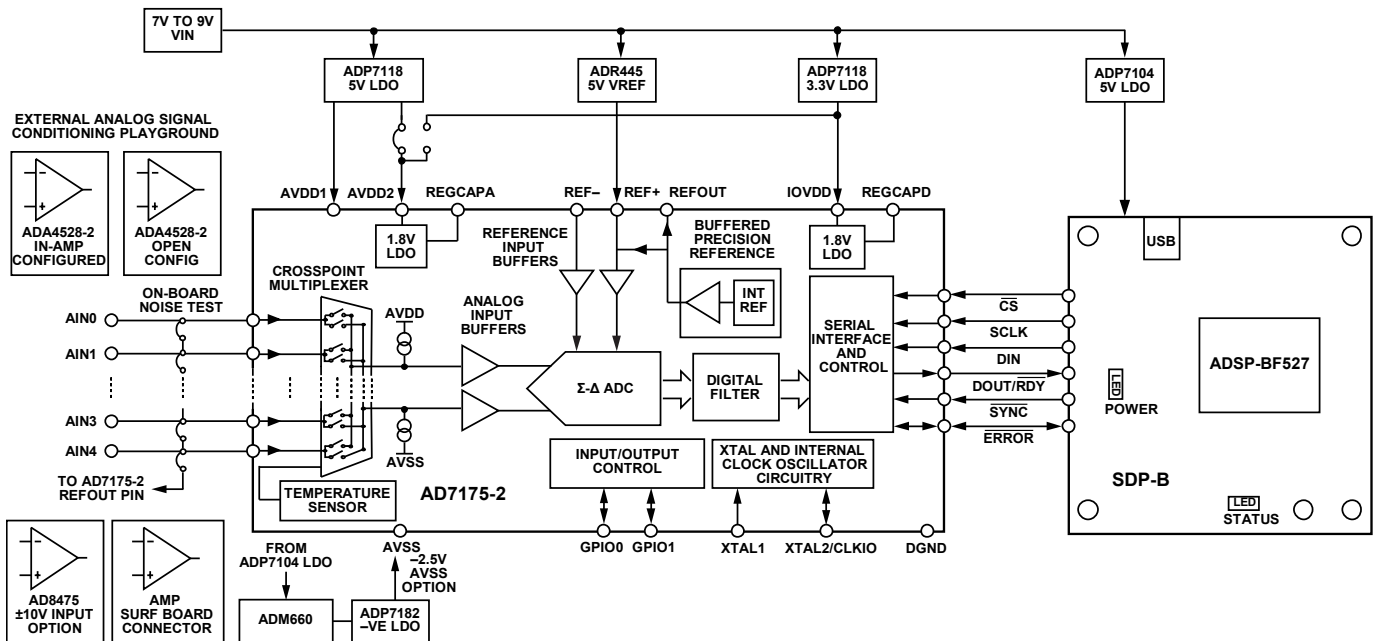

Figure 1.

TABLE OF CONTENTS

Features	1
Evaluation Kit Contents.....	1
Equipment Needed.....	1
General Description.....	1
Functional Block Diagram	1
Revision History	2
EVAL-AD7175-2SDZ Quick Start Guide	3
Recommended Quick Start Guide	3
Quick Start Noise Test	3
Evaluation Board Hardware.....	4
Device Description.....	4
Hardware Link Options.....	4
Sockets and Connectors	5
Serial Interface	6
Power Supplies	6
Power Supply Configurations	7
Analog Inputs.....	7

REVISION HISTORY

1/2018—Rev. A to Rev. B

Changed EVAL-SDP-CB1Z to SDP-B.....	Throughout
Changed AD7175-2 Eval+ to AD717x Eval+	Throughout
Changes to Evaluation Kit Contents Section, Equipment Needed Section, and General Description Section	1
Changes to Table 1.....	4
Changes to Table 2.....	5
Changes to Power Supply Configuration Section	7
Changes to Software Installation Section, Figure 3, Figure 3 Caption, Figure 4, and Figure 4 Caption	8
Added Figure 5 and Figure 6; Renumbered Sequentially	8
Added Figure 7 through Figure 11	9
Added Setting Up the System for Data Capture Section.....	10
Added Figure 13 and Figure 14.....	10
Changes to Launching the Software Section, Figure 12, Figure 12 Caption, Figure 15, and Figure 15 Caption.....	10
Changed to Software Operation Section to Evaluation Board Software Operation Section	11
Changes to Figure 16.....	11
Changes to Figure 17	12
Changes to Overview of the Main Window Section and Configuration Tab (1) Section	12
Changes to Waveform Tab (18) Section	14
Changes to Figure 18 and Figure 18 Caption	15
Changes to Histogram Tab (26) Section, Figure 19, and Figure 19 Caption	16
Changed Calculated Performance Tab (29) Section to Modelled Performance Tab (31) Section.....	17
Changes to Modelled Performance Tab (31) Section, Figure 20, and Figure 20 Caption.....	17
Added Figure 21.....	18
Added Figure 22.....	19

Reference Options	7
Evaluation Board Software.....	8
Software Installation	8
Setting up the System for Data Capture	10
Launching the Software.....	10
Evaluation Board Software Operation.....	11
Overview of the Main Window.....	12
Configuration Tab (1).....	12
Waveform Tab (18).....	14
Histogram Tab (28).....	16
Modelled Performance Tab (31).....	17
Registers Tab (45).....	20
Exiting the Software.....	20
Evaluation Board Schematics and Artwork.....	21
Ordering Information.....	29
Bill of Materials.....	29

Changed Register Map Tab (34) Section to Registers Tab (45) Section.....	20
Changes to Registers Tab (45) Section and Figure 23	20
Added Evaluation Board Schematics and Artwork Section	21
Added Ordering Information Section and Table 4.....	29

6/2015—Rev. 0 to Rev. A

Changed Evaluation Software to Eval+ Software.....	Throughout
Changes to Evaluation Kit Contents Section, General Description Section, and Figure 1.....	1
Changes to Quick Start Noise Test Section and Figure 2.....	3
Changes to Table 1	4
Changes to Table 3.....	6
Changes to Single Supply (Unregulated) Section, Split Supply (Regulated) Section, and Split Supply (Unregulated) Section.....	7
Changes to Evaluation Board Software Section	8
Changes to Overview of the Main Window Section	9
Added Evaluation Mode (2) Section, Analog Supply Voltage (9 and 13) Section, Digital Supply Voltage (10) Section, Analog Input Voltage (11) Section, External SCLK Frequency (12) Section, and External MCLK Frequency (14) Section	9
Changes to Figure 7.....	10
Added Figure 8; Renumbered Sequentially	11
Changes to Figure 9.....	13
Changes to Figure 10.....	14
Added Calculated Performance Tab (29) Section, Filter Profile and Response (30 and 31) Section, Performance Summary (32) Section, Timing Diagram (33) Section, and Figure 11.....	15
Changes to Figure 12.....	16

11/2014—Revision 0: Initial Version

EVAL-AD7175-2SDZ QUICK START GUIDE

RECOMMENDED QUICK START GUIDE

Follow these steps to set up the evaluation board:

1. Disconnect the **SDP-B** board from the USB port of the PC. Install the AD717x Eval+ software from the enclosed CD. Restart the PC after installation.
2. Connect the **SDP-B** board to the evaluation board, as shown in Figure 2.
3. Fasten the two boards together with the enclosed plastic screw washer set.
4. Connect the external 9 V power supply to Connector J5 of the evaluation board as shown in Figure 2. Set Link LK2 to Position B.
5. Connect the **SDP-B** board to the PC via the USB cable.
6. Launch the AD717x Eval+ software from the **Analog Devices** subfolder in the **Programs** menu.

QUICK START NOISE TEST

Use the following procedure to quickly test the noise performance:

1. Insert Link LK8 to Link LK12 to initiate the noise performance test mode. In this mode, analog input channels short to the REFOUT pin.
2. Click **Start Sampling** to acquire samples from the ADC (see Figure 16).

The **Samples** numeric control in the top right corner of the main window sets the number of samples collected in each batch (see Figure 16).

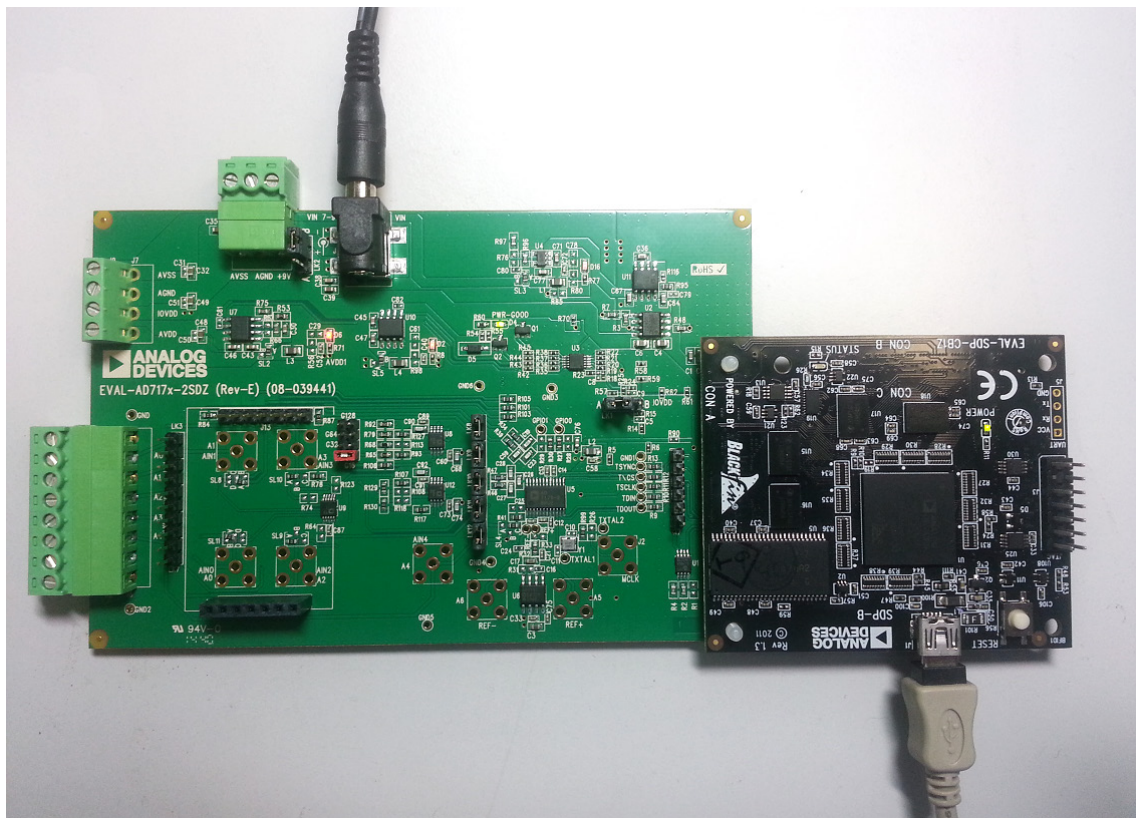

Figure 2. Hardware Configuration, Setting Up the EVAL-AD7175-2SDZ Evaluation Board

12526-002

EVALUATION BOARD HARDWARE

DEVICE DESCRIPTION

The [AD7175-2](#) is a highly accurate, high resolution, multiplexed, 2-/4-channel (fully differential/single-ended) Σ - Δ ADC. The [AD7175-2](#) has a maximum channel-to-channel scan rate of 50 kSPS (20 μ s) for fully settled data. The output data rates range from 5 SPS to 250 kSPS. The device includes integrated rail-to-rail analog input and reference input buffers, an integrated precision 2.5 V reference, and an integrated oscillator.

See the [AD7175-2](#) data sheet for complete specifications. Consult the data sheet in conjunction with this user guide when using the evaluation board. Full details for the [SDP-B](#) are available at the [SDP-B](#) product page on the Analog Devices website.

HARDWARE LINK OPTIONS

See Table 1 for default link options. By default, the evaluation board is configured to operate from the supplied 9 V ac-to-dc adapter connected to connector J5. The 5 V supply required for the [AD7175-2](#) comes from the [ADP7118](#) on-board low dropout regulator (LDO). The [ADP7118](#), with a 5 V output voltage, receives its input voltage from J3 or J5 (depending on the position of LK2) and generates a 5 V output.

Table 1. Default Link and Solder Link Options

Link	Default Option	Description
LK1	A	Selects the voltage applied to the power supply sequencer circuit (U3); dependent on AVDD1. Place in Position A if using 5 V AVDD1, or Position B if using 2.5 V AVDD1.
LK2	B	Selects the external power supply from Connector J3 (Position A) or Connector J5 (Position B).
LK3 to LK7	Not inserted	Prior to inserting SL8 to SL11, insert these links sets up the on-board noise test to short the inputs to the on-board amplifiers, U8 and U9. In this mode, all inputs short to REFOUT.
LK8 to LK12	Inserted	Inserting these links sets up the on-board noise test close to the ADC analog inputs. In this mode, all inputs short to REFOUT.
SL1	A	Sets the voltage applied to the AVDD2 pin. Operates using the AVDD1 supply (default). Position B sets the AVDD2 voltage to 3.3 V supply from the ADP7118 (3.3 V) (U10) regulator.
SL2	A	Selects between an external (Position B) or on-board AVDD1 source (Position A). Supplies AVDD1 from the ADP7118 (5 V) (U7) (default).
SL3	A	Selects between an external (Position B) or on-board AVSS (Position A) source. Supplies AVSS from the ADP7182 (-2.5 V) (U4) (default).
SL4	C	Connects AIN4 to: A4/J6 (Position A), REFOUT pin on the AD7175-2 (Position B), or AVSS (Position C). Position B and Position C are used to simplify using a single-ended input source.
SL5	B	Selects between an external or on-board IOVDD source. Supplies IOVDD from the ADP7118 (3.3 V) (U10) (default). The evaluation board operates with a 3.3 V logic.
SL8	A	Routes A0 to: AIN0 pin on the AD7175-2 (Position A), Buffer/In-amp U8 (Position B), Funnel Amp U9 with gain of 0.8 \times (Position C), or J10-1 (Position D).
SL9	A	Routes A2 to: AIN2 pin on the AD7175-2 (Position A), Buffer U12 (Position B), or Funnel Amp U9 gain of 0.4 \times (Position C).
SL10	A	Routes A3 to: AIN3 pin on the AD7175-2 (Position A), Buffer U12 (Position B), or Funnel Amp U9 gain of 0.4 \times (Position C).
SL11	A	Routes A1 to: AIN1 pin on the AD7175-2 (Position A), Buffer/In-amp U8 (Position B), Funnel Amp U9 with gain of 0.8 \times (Position C), or J10-7 (Position D).
G16	Inserted	Sets the on board in-amp (U8) to a gain of 16. Insert only one of G16, G32, G64, and G128 at a time.
G32	Not inserted	Sets the on-board in-amp (U8) to a gain of 32. Insert only one of G16, G32, G64, and G128 at a time.
G64	Not inserted	Sets the on-board in-amp (U8) to a gain of 64. Insert only one of G16, G32, G64, and G128 at a time.
G128	Not inserted	Sets the on-board in-amp (U8) to a gain of 128. Insert only one of G16, G32, G64, and G128 at a time.
R49 to R51	Inserted	Connects AVSS and AGND for single-supply operation. To operate in split supply mode, remove these links.

SOCKETS AND CONNECTORS

Table 2. Connector Details

Connector	Function	Connector Type	Manufacturer	Manufacturer Number	Order Code ¹
J1	Connector to the SDP-B	120-way connector, 0.6 mm pitch	Hirose	FX8-120S-SV(21)	FEC1324660
J2	External MCLK input	Straight PCB mount SMB/SMA jack	TE Connectivity	1-1337482-0	Not applicable
J3	External bench top voltage supply for the EVAL-AD7175-2SDZ	Power socket block, 3-pin, 3.81 mm pitch	Phoenix Contact	MC 1,5/ 3-G-3,81	FEC3704737
J5	External ac-to-dc adapter input for the EVAL-AD7175-2SDZ , 7 V to 9 V	DC power connectors, 2 mm SMT power jack	Kycon	KLDX-SMT2-0202-A	MOUSER 806-KLDX-SMT20202A
J6	Analog input terminal block; wired connection to external source or sensor	Power socket block, 8-pin, 3.81 mm pitch	Phoenix Contact	MC 1,5/ 8-G-3,81	FEC3704774
J9	External bench top voltage supply option for AVDD1/AVDD2, IOVDD, and AVSS inputs on the AD7175-2	Screw terminal block, 3.81 mm pitch	Phoenix Contact	MKDS 1/4-3.81	FEC3704592
J10	Optional header	7-way, 2.54 mm pin header	Samtec	SSW-107-01-T-S	FEC1803478
J13	Optional header	7-way, 2.54 mm socket	Samtec	TLW-107-05-G-S	FEC1668499
A0 to A4	Analog inputs to ADC	Straight PCB mount SMB/SMA jack	TE Connectivity	1-1337482-0	Not applicable
A7	PMOD-compatible header	6-Pin SIL header (0.1" pitch)	Harwin	20-9990646	FEC 1022255

¹ Order codes starting with FEC are for Farnell.

SERIAL INTERFACE

The [EVAL-AD7175-2SDZ](#) evaluation board connects via the serial peripheral interface (SPI) to the Blackfin® [ADSP-BF527](#) on the [SDP-B](#). There are four primary signals: \overline{CS} , SCLK, and DIN (all inputs), and one output from the ADC, DOUT/ \overline{RDY} .

To operate the evaluation board in standalone mode, disconnect the evaluation board from the [SDP-B](#) controller board. Use the test points to connect the signals to an alternative digital capture setup or the PMOD-compatible header (A7).

POWER SUPPLIES

Power the evaluation board from the ac-to-dc adapter connected to J5, or from an external bench top supply applied to J3 or J9. Linear LDOs generate the required voltages from the applied input voltage (V_{IN}) rail when using J3 or J5. Use J9 to bypass the on-board regulators. An [ADP7118](#) regulator generates the 5 V (single supply) and 2.5 V (split supply) supplies for the AVDD1 and AVDD2 rails to the ADC; a second [ADP7118](#) generates 3.3 V for the IOVDD rail. The [ADP7104](#) supplies 5 V for the [SDP-B](#) controller board as well as 5 V for the [ADM660](#) voltage converter to generate -5 V to supply the [ADP7182](#). The [ADP7182](#) generates the -2.5 V supply for AVSS when operating in split supply mode. Each supply is decoupled where it enters the board and again at each device in accordance with the schematic. Table 3 shows the various power supply configurations available, including split supply operation.

Table 3. Power Supply Configurations¹

Configuration	Input Voltage Range	Description
Single Supply (Regulated)	7 V to 9 V	The 7 V to 9 V input is regulated to 5 V for AVDD1/AVDD2 and 3.3 V for IOVDD. This also powers the external 5 V reference. See the Single Supply (Regulated) section in the Power Supply Configurations section.
Single Supply (Unregulated)	7 V to 9 V, 5 V, and 3.3 V	The input is unregulated and connects directly to AVDD1/AVDD2 and IOVDD from J5. The 7 V to 9 V input powers the external 5 V reference. See the Single Supply (Unregulated) section in the Power Supply Configurations section.
Split Supply (Regulated)	7 V to 9 V	The 7 V to 9 V input is regulated to 2.5 V for AVDD1/AVDD2, -2.5 V for AVSS, and 3.3 V for IOVDD. The 7 V to 9 V input powers the external 5 V reference. See the Split Supply (Regulated) section in the Power Supply Configurations section.
Split Supply (Unregulated)	7 V to 9 V, ± 2.5 V, and 3.3 V	The input is unregulated and connects directly to AVDD1/AVDD2 and IOVDD from J5. The 7 V to 9 V input powers the external 5 V reference. See the Split Supply (Unregulated) section in the Power Supply Configurations section.

¹ Only one configuration can be used at a time.

POWER SUPPLY CONFIGURATIONS

Single Supply (Regulated)

There are two available power supply options for the single supply (regulated) configuration.

- An ac-to-dc adapter (included) connected to J5. Set LK2 to Position B.
- A bench top power supply connected to J3. Set LK2 to Position A, and ensure that $AVSS = AGND = 0\text{ V}$.

Set all other links and solder links to the default settings as outlined in Table 1.

Single Supply (Unregulated)

To set up the evaluation board, use the following procedure:

1. Move SL2 to Position B and SL5 to Position A.
3. Connect the two terminals of J9 labeled AGND and AVSS.
4. Connect 0 V (GND) to J9 at the terminal labeled AGND.
5. Connect 5 V to J9 at the terminal labeled AVDD.
6. Connect 3.3 V to J9 at the terminal labeled IOVDD.
7. Connect the 7 V to 9 V input to J5.

Set all other links and solder links to the default settings as outlined in Table 1.

Split Supply (Regulated)

To set up the evaluation board, use the following procedure:

1. Remove R49 to R52. These links connect AVSS to AGND.
2. Insert a 0 Ω resistor for R67 and R85.
3. Set LK1 to Position B, which sets the input to the power monitor circuitry to work with the lower AVDD1 supply of 2.5 V.
4. Connect a bench top power supply to J5 and set LK2 to Position B.

Set all other links and solder links to the default settings as outlined in Table 1.

Split Supply (Unregulated)

To set up the evaluation board, use the following procedure:

1. Move SL2, SL3 to Position B and SL5 to Position A.
2. Remove R49 to R52.
3. Insert a 0 Ω resistor at R67 and R 85.
4. Connect 0 V (GND) to J9 at the terminal labeled AGND.
5. Connect 2.5 V to J9 at the terminal labeled AVDD.
6. Connect -2.5 V to J9 at the terminal labeled AVSS.
7. Connect 3.3 V to J9 at the terminal labeled IOVDD.
8. Connect 7 V to 9 V to J5.
9. Set LK1 to Position B. This sets the input to the power monitor circuitry to work with the lower AVDD1 supply of 2.5 V.

Set all other links and solder links set to the default settings as outlined in Table 1.

ANALOG INPUTS

The primary analog inputs of the [EVAL-AD7175-2SDZ](#) evaluation board can be applied in two separate ways.

- J6 connector on the left side of the board
- A0 to A4 SMB/SMA footprints on the evaluation board

The analog inputs route directly to the associated analog input pins on the [AD7175-2](#), provided that the LK5 to LK9 links (on-board noise test) are removed. The AD717x Eval+ software is set up to analyze dc inputs to the ADC. The [AD7175-2](#) input buffers work for dc input signals.

REFERENCE OPTIONS

The [EVAL-AD7175-2SDZ](#) evaluation board includes an external 5 V reference, the [ADR445](#). The [AD7175-2](#) includes an internal 2.5 V reference. The default operation is to use the external reference input, which is set to accept the 5 V [ADR445](#) on the evaluation board.

EVALUATION BOARD SOFTWARE SOFTWARE INSTALLATION

The [EVAL-AD7175-2SDZ](#) evaluation kit includes software on a CD. Double-click the **setup.exe** file from the CD to run the installer. The default installation location for the software is **C:\Program Files\Analog Devices\AD717x Eval+**.

Install the AD717x Eval+ software before connecting the evaluation board and [SDP-B](#) board to the USB port of the PC to ensure that the evaluation system is correctly recognized when connected to the PC.

There are two parts to the installation.

1. AD717x Eval+ software installation.
2. AD717x Eval+ Dependencies
 - a. [SDP-B](#) board drivers
 - b. Ssrc SVG plug-in installation
 - c. Microsoft .Net Framework v3.5

Warning

To ensure the PC correctly recognizes the evaluation system, the evaluation software drivers must be installed before connecting the [EVAL-AD7175-2SDZ](#) evaluation board and [SDP-B](#) boards to the USB port of the PC.

Installing the AD717x Eval+ Software

To install the AD717x Eval+ software take the following steps:

1. With the [SDP-B](#) disconnected from the USB port of the PC, insert the AD717x Eval+ software installation CD into the CD-ROM drive. Double-click the **setup.exe** file to begin the evaluation board software installation.
2. The default installation location for the software is **C:\Program Files\Analog Devices\AD717x Eval+**.
3. A dialog box appears asking for permission to allow the program to make changes to the PC. Click **Yes** to proceed (see Figure 3).

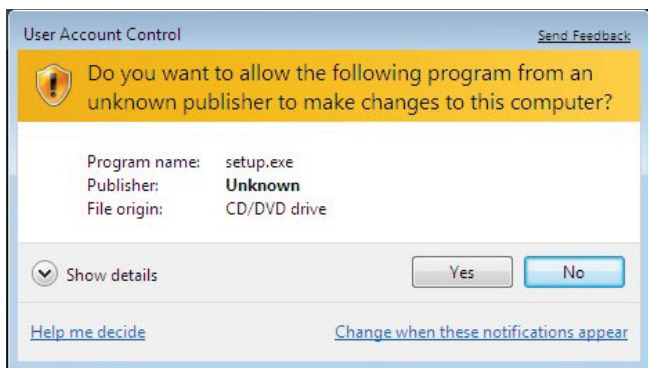

Figure 3. **User Account Control** Permission Dialog Box

4. Select a location to install the software and click **Next**. Figure 4 shows the default locations displayed when the dialog box opens. To select another location click **Browse**.

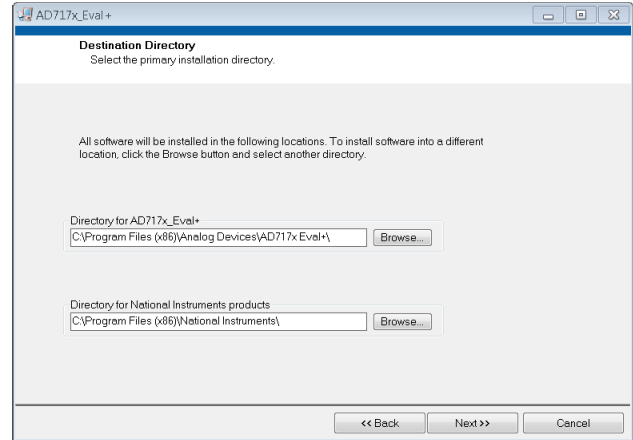

Figure 4. **AD717x Eval+** Installation, Selecting the Location for Software Installation

5. A license agreement appears. Read the agreement, select **I accept the License Agreement**, and click **Next**.

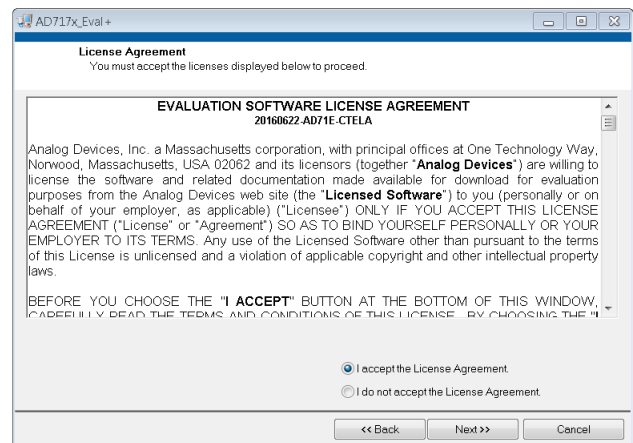

Figure 5. **AD717x Eval+** Installation, Accepting the License Agreement

6. A summary of the installation displays. Click **Next** to continue.

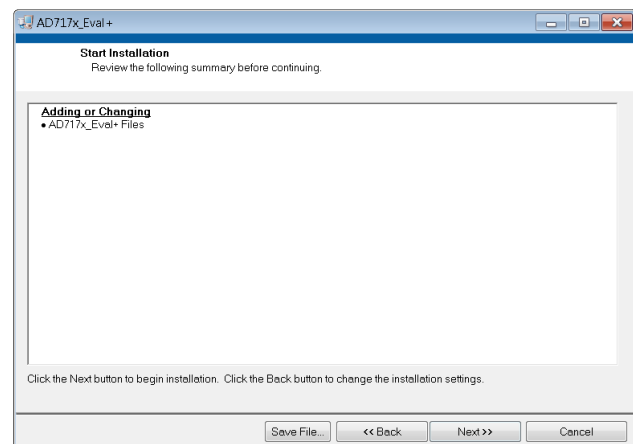

Figure 6. **AD717x Eval+** Installation, Reviewing a Summary of the Installation

- The message in Figure 7 appears when the installation is complete.

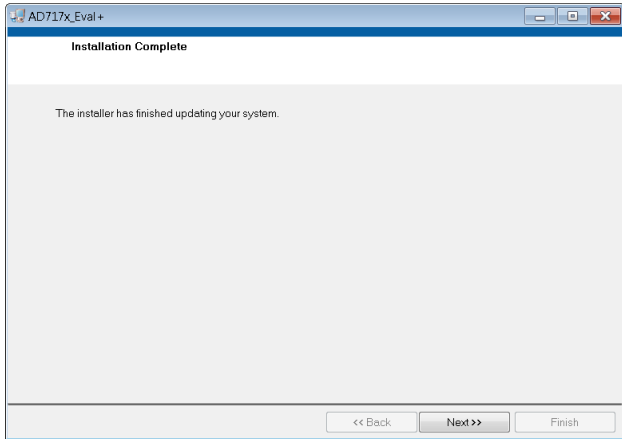

Figure 7. AD717x Eval+ Installation Complete

Installing the Eval+ Dependencies

After installation of the evaluation software is complete, a welcome window displays to install the Eval+ Dependencies.

- With the SDP-B board still disconnected from the USB port of the PC, make sure all other applications are closed, then click **Install**.

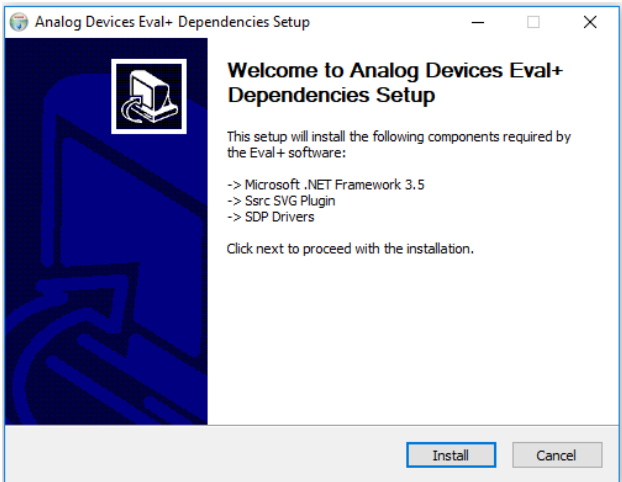

Figure 8. Eval+ Dependencies Setup, Beginning the Drivers Installation

- The Ssrc SVG plug-in will install first, then the SDP-B drivers, and finally the .Net Framework.
- If using Windows 8 or Windows 10 see the Installing the .Net Framework v3.5 on Windows 8 and Windows 10 section.
- To complete the drivers installation click **Close**. This closes the installation setup wizard.

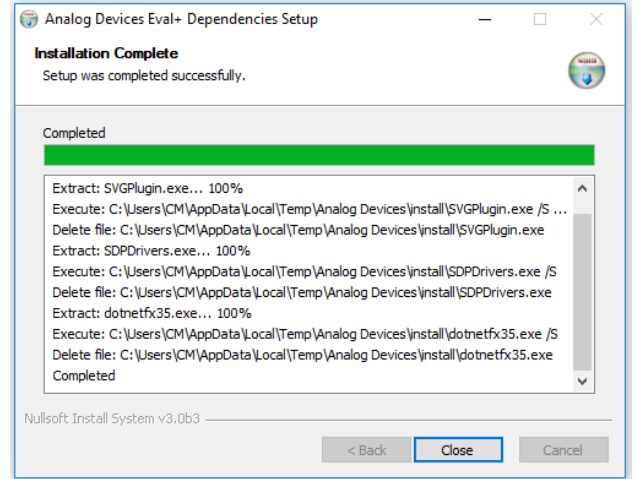

Figure 9. Eval+ Dependencies Setup, Completing the Driver Setup Wizard

- Before using the evaluation board, the user must restart the PC.

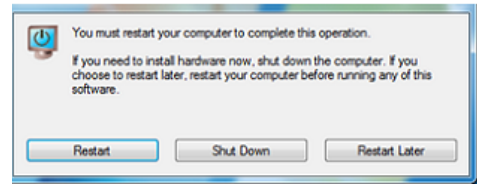

Figure 10. Restarting the PC

Installing the .Net Framework v3.5 on Windows 8 and Windows 10

Windows 8 and Windows 10 have a built in installer for the .Net Framework v3.5. In order to run this software the user will need an internet connection and may need administrator privileges. Complete the following steps to install the software. If unable to install the .Net Framework contact your system administrator.

- When the Eval+ Dependencies installer reaches the .Net Framework, the window shown in Figure 11 will appear.

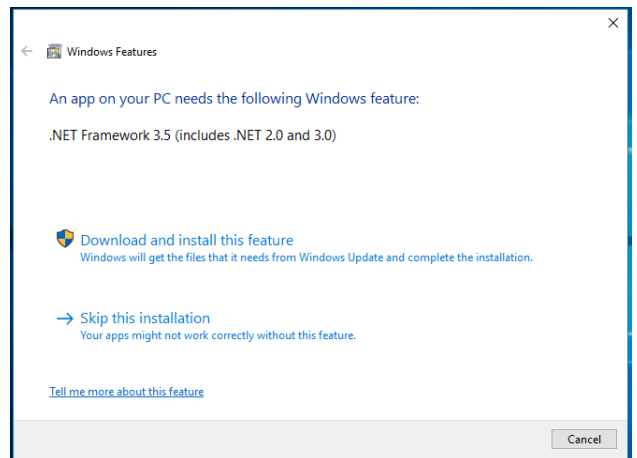

Figure 11. Restarting the PC

- Follow the steps in the installation wizard to complete the installation.

- If the window in Figure 11 does not appear; v3.5 may already be installed. To check if the software is already installed open **Control Panel > Programs > Programs and Features** and select **Turn Windows features on or off**. Check that the .Net Framework v3.5 is enabled.

SETTING UP THE SYSTEM FOR DATA CAPTURE

After completing the steps in the Software Installation section and the Evaluation Board Hardware section, set up the system for data capture using the following steps.

- Allow the **Found New Hardware Wizard** to run after the **SDP-B** board is connected to the PC. (If using Windows XP, search for the **SDP-B** drivers. Choose to automatically search for the drivers if prompted by the operating system.)
- Check that the board is connecting to the PC correctly using the **Device Manager**.
- Access the **Device Manager** by right clicking **My Computer**, then **Manage**. A dialog box appears asking for permission to allow the program to make changes to the PC. Click **Yes**. The **Computer Management** box appears. Click **Device Manager** from the list of **System Tools** (see Figure 12).
- The **SDP-B** board appears under **ADI Development Tools**. This indicates that the driver software has installed and the board is connected to the PC correctly.

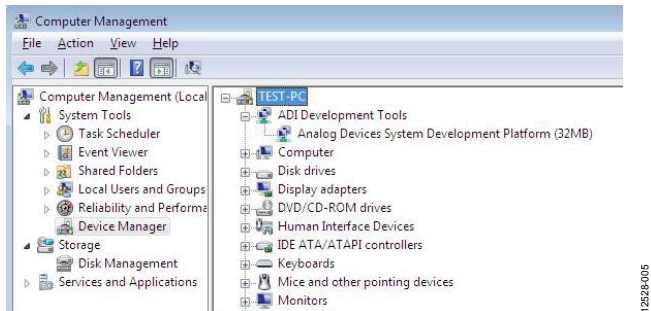

Figure 12. Device Manager, Checking the Board Connected to the PC Correctly

LAUNCHING THE SOFTWARE

After completing the steps in the Setting up the System for Data Capture section, launch the AD717x Eval+ software using the following steps:

- From the **Start** menu, click **Programs > Analog Devices > AD717x Eval+**.
- The dialog box in Figure 13 appears, select **AD7175 Evaluation Board**. The main window of the software box displays as shown in Figure 16.

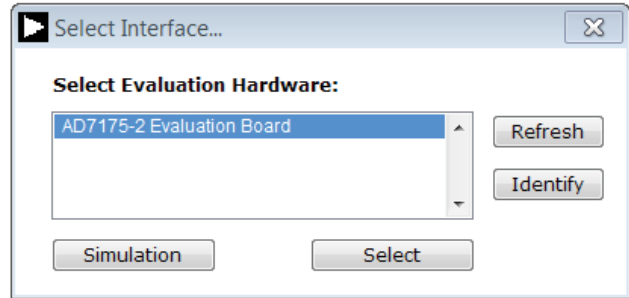

Figure 13. AD7175-2 Evaluation Board Selection

- If the **EVAL-AD7175-2SDZ** evaluation system is not connected to the USB port via the **SDP-B**, when the software is launched the **Select Interface** dialog box appears (see Figure 14). Connect the evaluation board to the USB port of the PC, wait a few seconds, click **Refresh** and the option shown in Figure 13 appears.

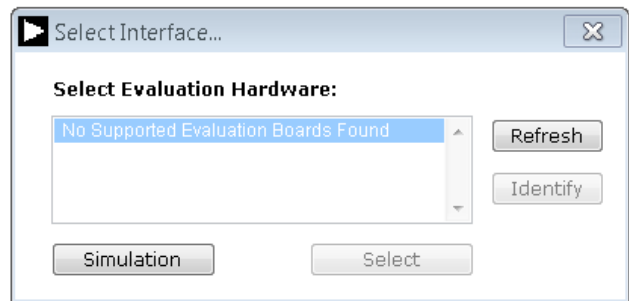

Figure 14. Evaluation Board Selection, No Board Connected

- The AD717x Eval+ software can also be used without connecting hardware. Click the **Simulation** button and the options shown in Figure 15 appear. The simulation mode uses a model and allows the **AD7172-2**, **AD7172-4**, **AD7173-8**, **AD7175-2**, **AD7175-8**, **AD7176-2**, or **AD7177-2** to be evaluated.

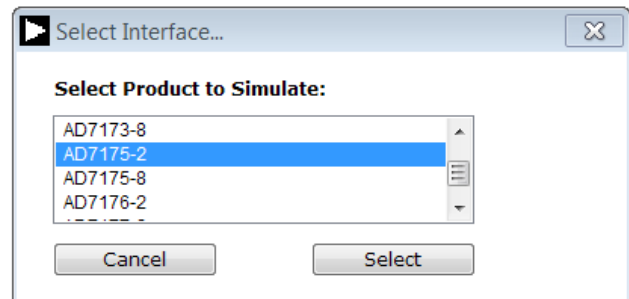

Figure 15. Evaluation Board Selection Simulation

EVALUATION BOARD SOFTWARE OPERATION

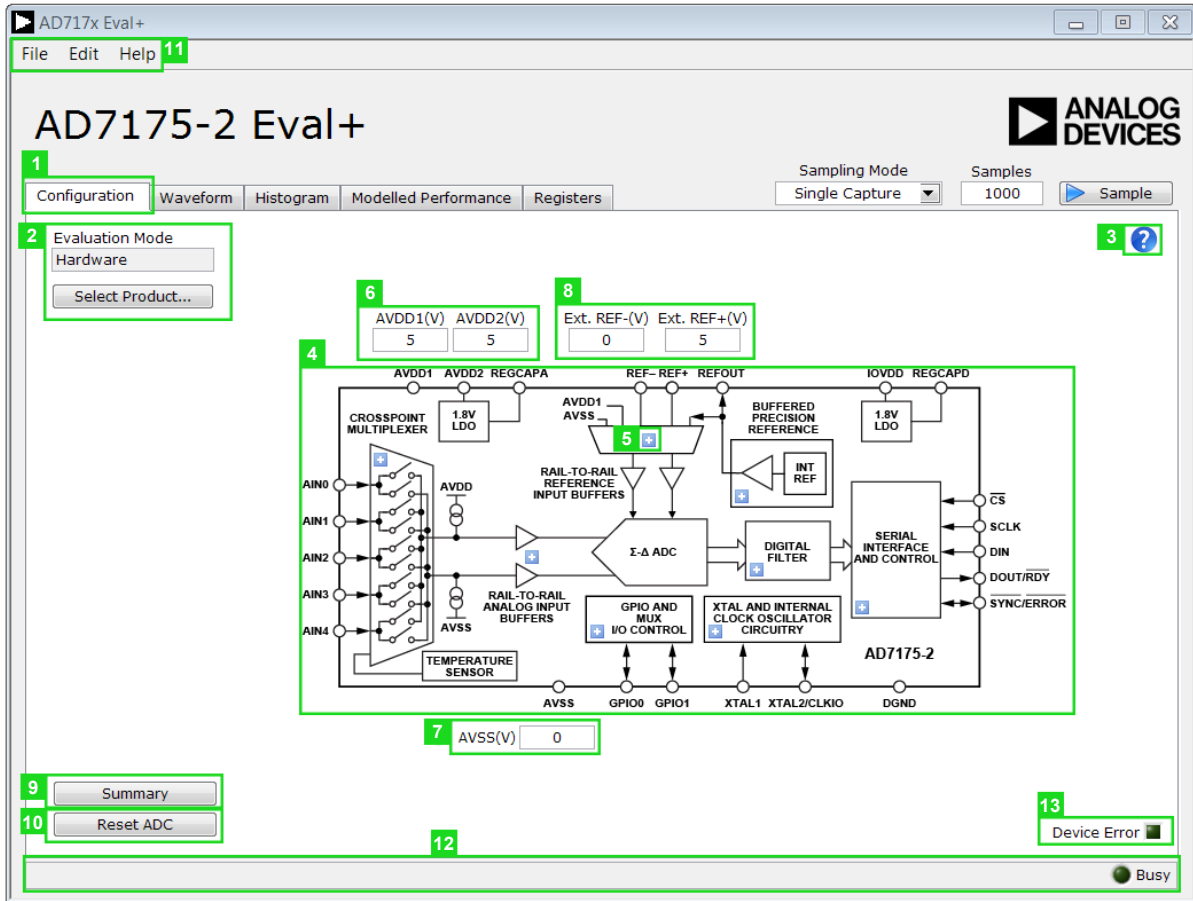

Figure 16. Configuration Tab of the AD7175-2 Eval+ Software in Hardware Mode

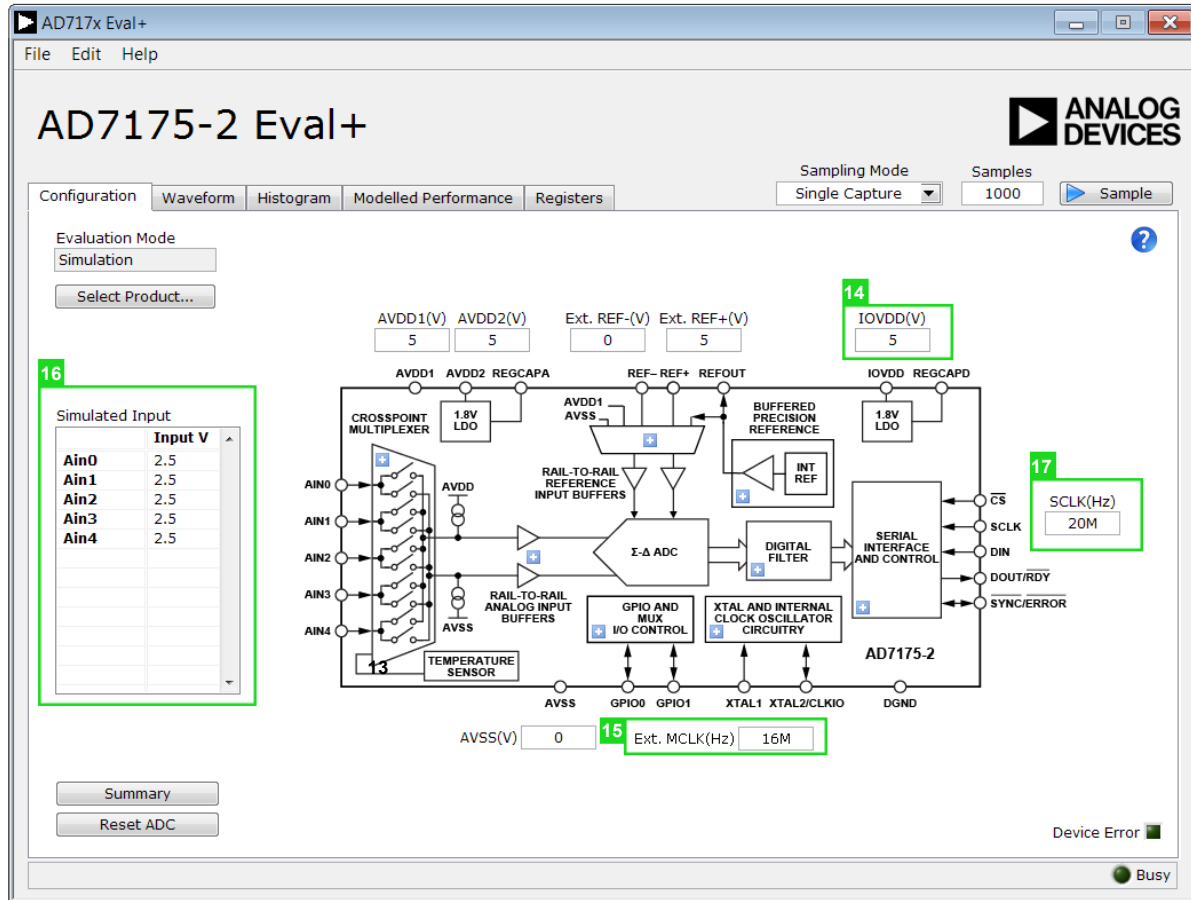

Figure 17. Configuration Tab of the AD7175-2 Eval+ Software in Simulation Mode

OVERVIEW OF THE MAIN WINDOW

The main window of the AD717x Eval+ software displays the significant control buttons and analysis indicators of the AD717x Eval+ software. The main window is divided into five tabs.

- Configuration
- Waveform
- Histogram
- Modelled Performance
- Registers

CONFIGURATION TAB (1)

Figure 16 shows the Configuration tab when Hardware Mode is selected and Figure 17 shows the Configuration tab when Simulation mode is selected. The controls highlighted in Figure 17 are only available in Simulation mode.

Evaluation Mode (2)

The Evaluation Mode indicator displays the current evaluation mode. To switch between modes, click the Select Product button and the dialog box shown in Figure 13 appears.

Tutorial Button (3)

Click the tutorial button to open a tutorial and access additional information on using the AD717x Eval+ software.

Functional Block Diagram (4)

The functional block diagram of the ADC shows each of the separate functional blocks within the ADC. Clicking a configuration pop-up button on any of the functional blocks opens the configuration pop-up window for the block selected. Not all blocks have a configuration button.

Configuration Pop-up Button (5)

Each configuration pop-up button opens a different window that allows the configuration of the relevant functional block.

Analog and Digital Supply Voltage (6, 7, and 14)

These input fields are used to take the supply voltage levels selected for the AD7175-2. Checks are performed to ensure the power supply voltage levels entered are within the specified limits. These power supply voltage levels are also used for the modelled performance to calculate the power dissipation.

External Reference (Ext. REF) (8)

The **Ext. REF** input fields set the positive and negative external reference voltage values. The difference is used for calculating the results for both the **Waveform** and **Histogram** tabs. The evaluation board has an external 5 V [ADR445](#) reference, which can be bypassed by removing R32. Change the external reference values in **Ext. REF** to ensure correct calculation of results in the **Waveform** and **Histogram** tabs.

Register Configuration Summary(9)

Click the **Summary** button to display the selected configuration of the [AD7175-2](#), this includes the channel configuration, information on each of the individual steps, and information on any error present.

Reset ADC (10)

Click the **Reset ADC** button to perform a software reset of the [AD7175-2](#). The [AD7175-2](#) does not have a hardware reset pin, to perform a hard reset the power must be removed from the board. The software reset has the same effect as a hard reset.

Menu Bar (11)

The menu bar has three section: **File**, **Edit**, and **Help**.

File

There are three options available in the **File** drop-down menu: Save, Load, and Generate.

Save

Save allows the user to save register configurations or waveform data. Register configurations can be saved as a JSON file or a header file. If the configuration is only used in the AD717x Eval+ software environment then it is recommended to use the JSON setting. Waveforms are saved as .csv files and the user is prompted to save the register configuration as well.

Load

Load allows the user to load saved register configurations or waveform data. In order to load a header into AD717x Eval+ it must be in the same format as one that is saved from AD717x Eval+. The header file can be used when developing firmware. When loading the waveform data the user is prompted to load the register configuration. This allows the software to correctly analyze the data.

Edit

There are two options in the **Edit** drop-down menu; Change Product Selection and Reset ADC. Change Product Selection performs the same action as the **Select Product** button and Reset ADC performs the same action as the **Reset ADC** button.

Help

The **Help** drop-down menu provides links to extra information about the [AD7175-2](#), which includes links to the [AD7175-2](#) product page, [EVAL-AD7175-2SDZ](#) evaluation board user guide, [AD7175-2](#) datasheet, and No-OS Drivers. Selecting the AD717x Eval+ Tutorial opens the tutorial outlined in the Tutorial Button (3) section. For details on the current version of the software the **About** option opens a dialog box displaying the current version of the software and relevant licenses.

Status Bar (12)

The status bar displays the busy indicator and status updates, such as **Analysis Completed** and **Reset Completed** during software use.

Device Error (13)

The Device Error LED icon illuminates when an ADC error is detected or when a cyclic redundancy check (CRC) error occurs. The CRC functionality on the [AD7175-2](#) is disabled by default and must be enabled for the Device Error indicator to work. Specific information on the error can be found in the Register Configuration Summary(9) section.

External MCLK Frequency (15)

This field sets the external MCLK frequency. The External MCLK Frequency (15) is only visible on the front panel when an external clock source is selected by the ADC. The External MCLK Frequency (15) is used by the functional model for modelled performance.

Analog Input Voltage (16)

These fields are only available when simulation mode is selected. These inputs allow the analog input voltages to be set and can be changed at any time while in simulation mode.

External SCLK Frequency (17)

This input field sets the external SCLK frequency for the SPI interface. This field is only available in simulation mode to determine if the SCLK frequency is within the permitted range.

WAVEFORM TAB (18)

Figure 18 shows the **Waveform** tab of the AD717x Eval+ software.

Sampling Mode (19)

This control is unrelated to ADC mode. The user can capture a defined sample set, single capture; or continuously gather batches of samples, repeated capture. The user can also select data logging that runs similar to repeated capture, but posts the results to a .csv file. When saving, the .csv file prompts the user to save the register configuration. This is necessary to load the data back into the software for analysis.

Samples (20)

The Samples field control sets the number of samples gathered per batch. Single capture returns the number entered into the Samples control. Repeated capture keeps returning batches of the number entered into the Samples control until stopped by the user.

Sample (21)

Click the **Sample** button to start gathering ADC results. Results appear in the waveform graph (22). See Figure 18.

Waveform Graph and Controls (22 and 23)

The data waveform graph shows each successive sample of the ADC output. Zoom in on the data using the control toolbar (labeled 23 in Figure 18). Click the x-axis and y-axis to change the scales on the graph.

Channel Selection (24)

The channel selection control allows the user to choose which channels display on the data waveform graph (23). These controls only affect the display of the channels and have no effect on the channel settings in the ADC register map.

Noise Analysis (25)

The **Noise Analysis** section displays the results of the noise analysis for the selected analysis channel, which includes both noise and resolution measurements.

Analysis Channel (26)

The **Noise Analysis** section and histogram graph show the analysis of the channel selected via the **Analysis Control** drop-down menu.

Display Units and Axis Controls (27)

The **Display Units** control affects both the waveform graph and the histogram graph. Click the **Display Units** drop-down menu to select the unit displayed in the graph. The axis controls can be switched between dynamic and fixed. When dynamic is selected, the axis automatically adjusts to show the entire range of the ADC results after each batch of samples. When fixed is selected, the user can program the axis ranges; the axis ranges do not automatically adjust after each batch of samples.

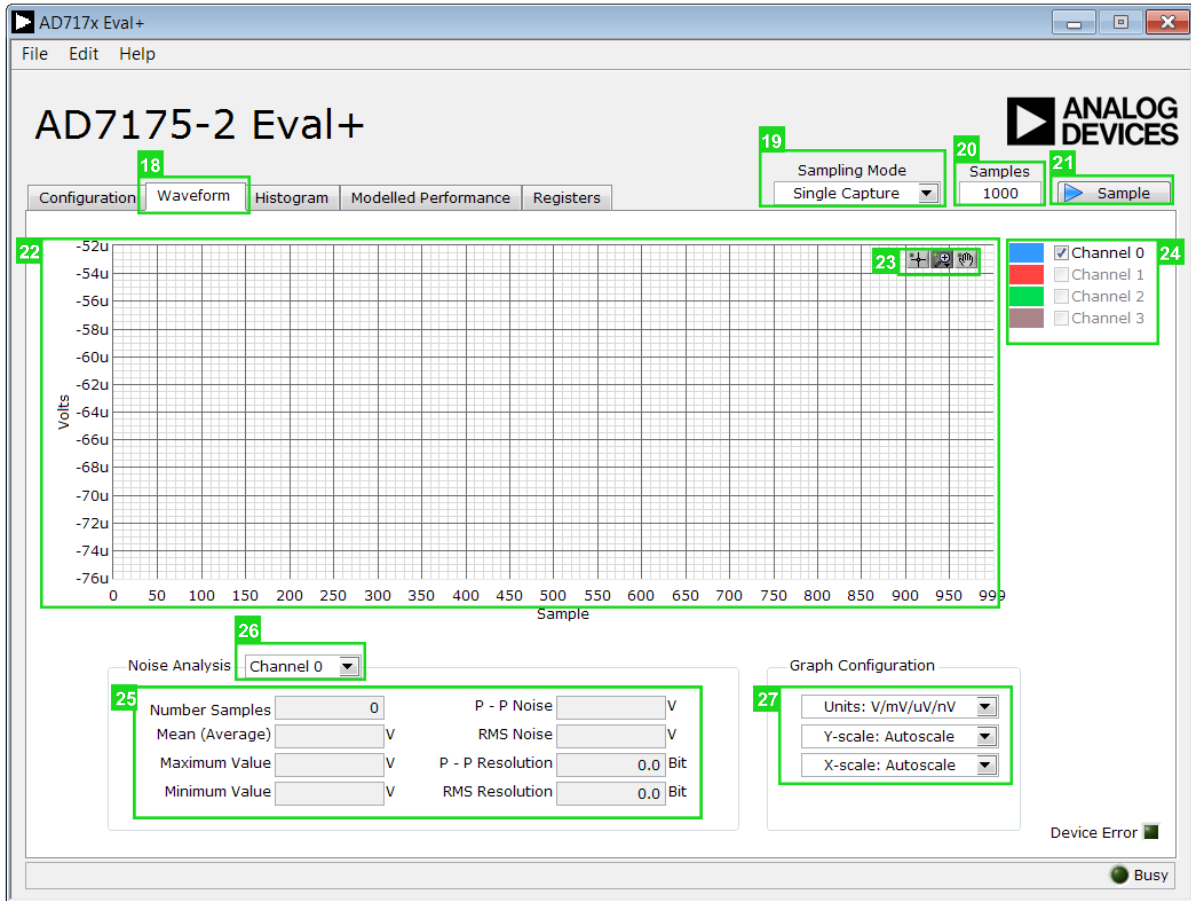

Figure 18. **Waveform** Tab of the **AD7175-2** Evaluation Software

12528-008

HISTOGRAM TAB (28)

Figure 19 shows the **Histogram** tab of the AD717x Eval+ Software.

Histogram Graph and Controls (29 and 30)

The data histogram graph (29) shows the number of times each sample of the ADC output occurs. The control toolbar (30) in the histogram graph allows the user to zoom in on the data (see Figure 19). Click the x-axis and y-axis to change the scales on the graph (see Figure 19).

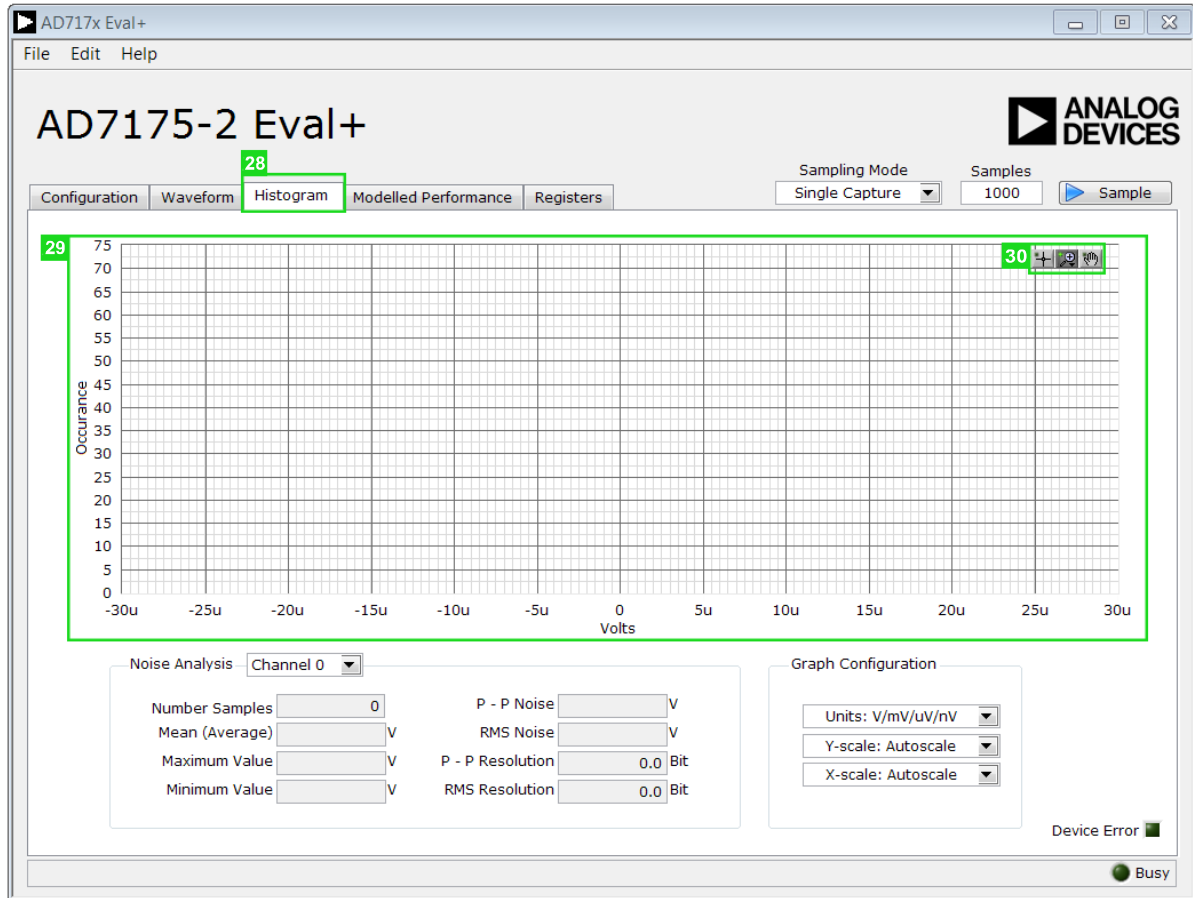

Figure 19. Histogram Tab of the AD7175-2 Eval+ Software

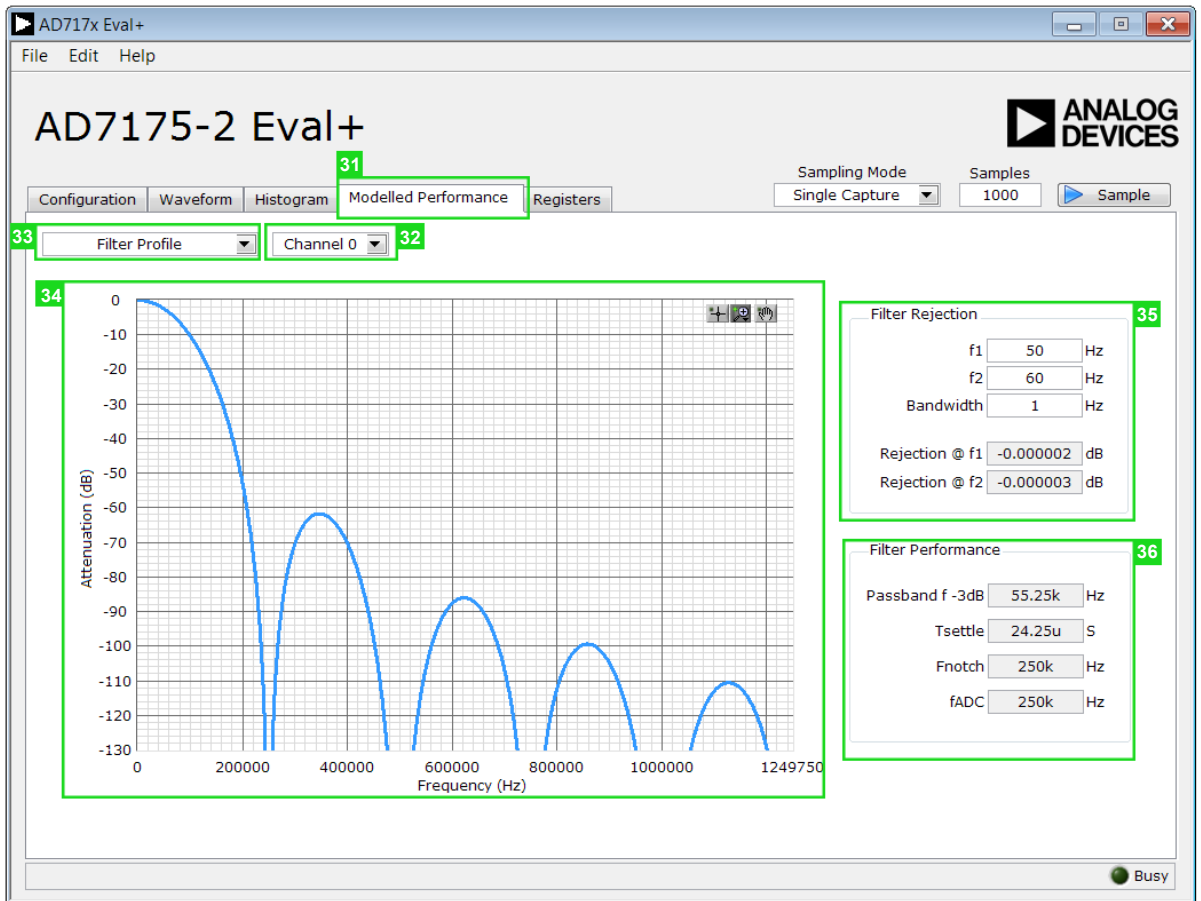

Figure 20. Filter Profiles of the AD7175-2 Evaluation Software

MODELLED PERFORMANCE TAB (31)

The **Modelled Performance** tab shows a number of ADC performance parameters, which are calculated using the ADC functional model. There are three main sections to the **Modelled Performance** tab; Filter Profile, Filter Step Response, and Timing Diagram/Power. These can be selected using the drop-down menu (33).

Analysis Channel (32)

The **Analysis Channel** drop-down menu selects the channel to be evaluated by the functional model.

Filter Profile (33)

The **Filter Profile** drop-down menu allows the user to switch between the three sections of the **Modelled Performance** tab. Figure 20 shows the **Modelled Performance** tab when filter profile is selected.

Filter Profile Graph (34)

This graph shows the frequency response for the selected digital filter. The graph controls allows the user to zoom in on the data. Click the x-axis and y-axis to change the scales on the graph.

Filter Rejection (35)

This section shows the rejection/attenuation of the digital filter over the rejection bandwidth (Rej.BW) for f1 and f2 in decibels; f1, f2, and Bandwidth can be changed.

Filter Performance (36)

This section shows the timing information about the data rate of the selected output. It shows the ADC initial settling time (**Tsettle**), the first frequency notch (**Fnotch**), and the actual sampling frequency (**fADC**).

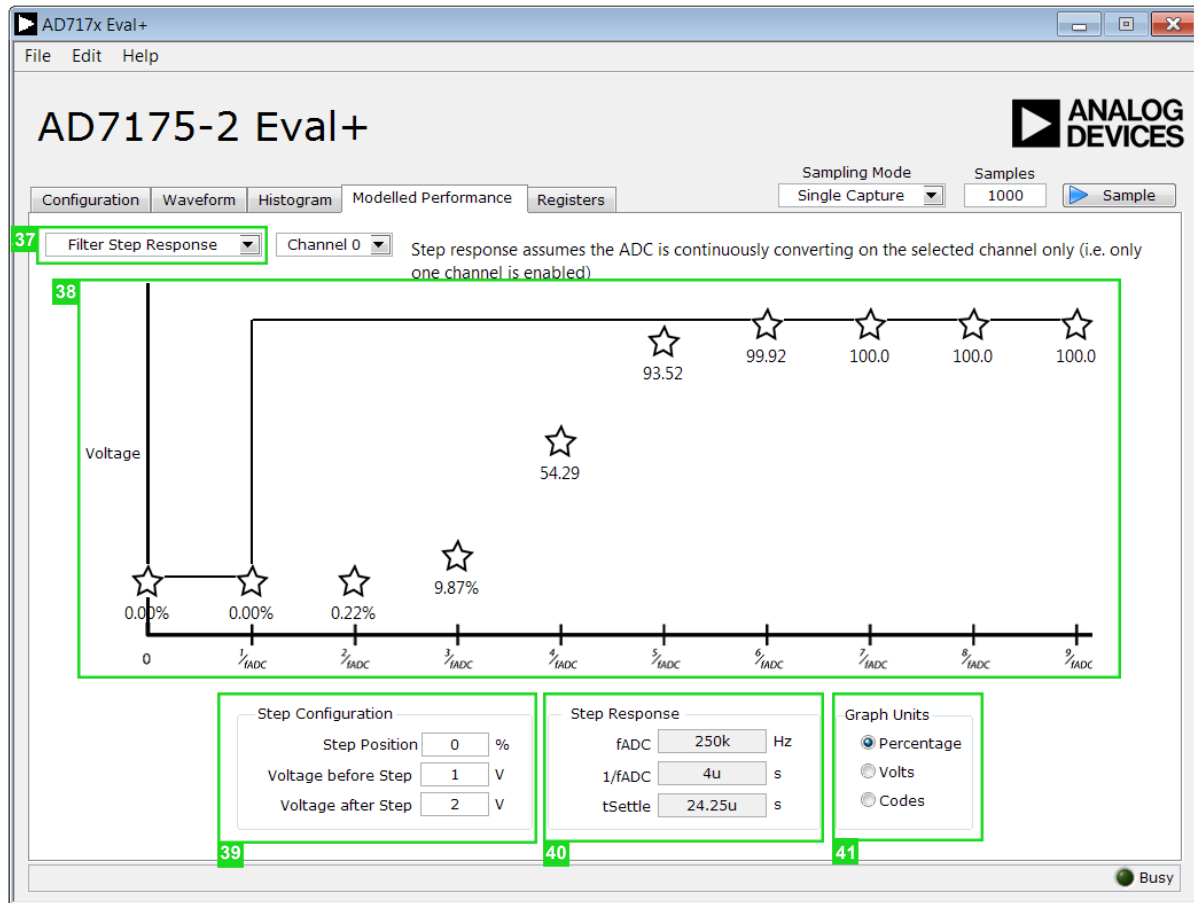

Figure 21. Filter Step Response of the AD7175-2 Evaluation Software

Filter Step Response (37)

This drop down menu allows the user to switch between the three sections of the **Modelled Performance** tab. Figure 21 shows the tab when Filter Step Response is selected.

Step Response Graph (38)

This graph shows how long the filter takes to settle when the voltage is stepped from one voltage to the next. For this analysis, it is assumed the ADC is continuously converting on only one channel.

Step Configuration (39)

Step Configuration allows the user to set the voltage before and after the step and the step position. Step position is set as a percentage where 0% is 1/fADC and 100% is 2/fADC.

Step Response (40)

This section shows timing information about the data rate of the selected output. It shows fADC, Tsettle, and the settling time between conversions, 1/fADC.

Graph Units (41)

Use this control to switch the step response between percentages, volts, and codes.

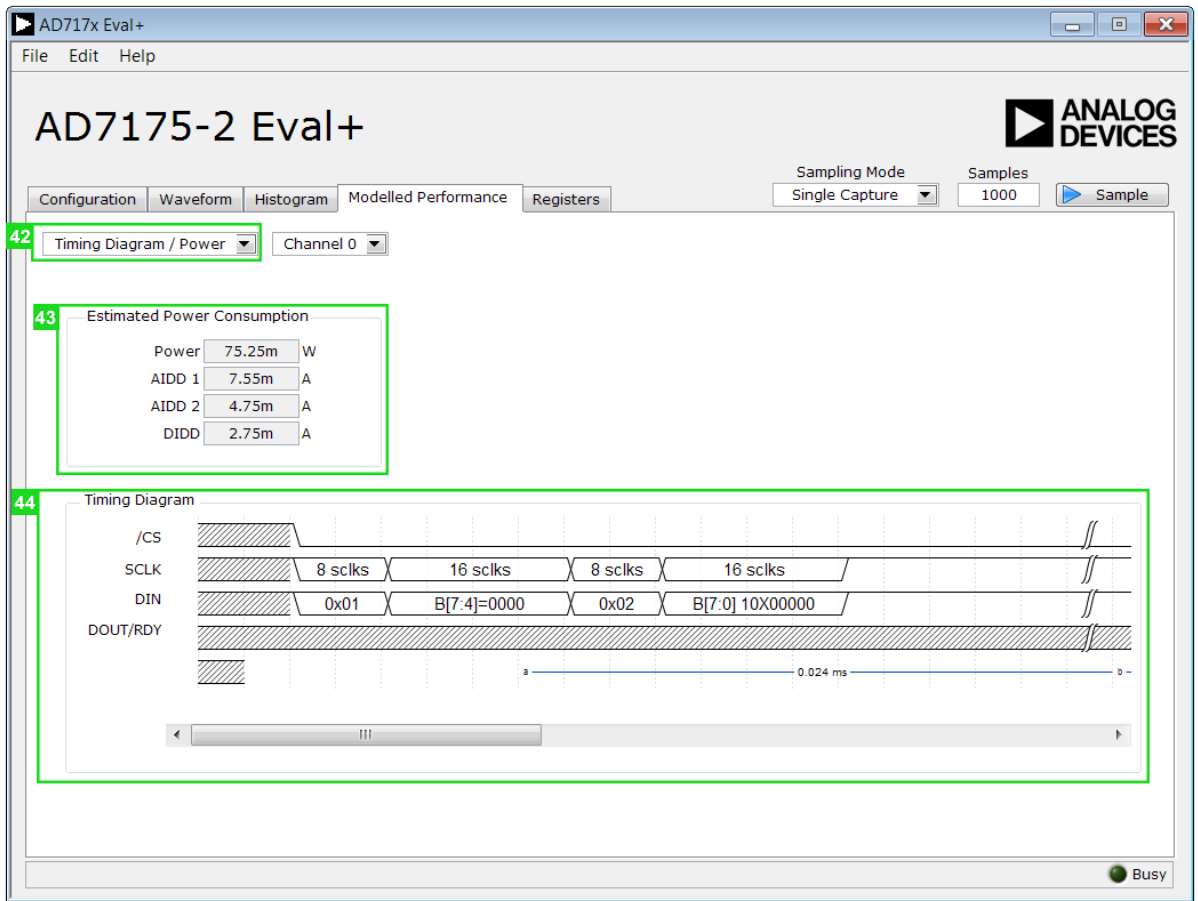

Figure 22. Timing Diagram/Power of the AD7175-2 Evaluation Software

Timing Diagram/ Power (42)

This drop down menu allows the user to switch between the three sections of the **Modelled Performance** tab. Figure 22 shows the **Modelled Performance** tab when Filter Step Response is selected.

Estimated Power Consumption (43)

This section shows the total power consumption of the device in the current configuration, as well as, the current consumption on each of the power supply rails. Note that the estimated power consumption is for the continuous conversion mode only and no other mode of operation is supported.

Timing Diagram (44)

This graph shows the digital interface timing diagram for the current configuration. The graph shows the timing for both the configuration of the ADC, and the subsequent data reads from the ADC.

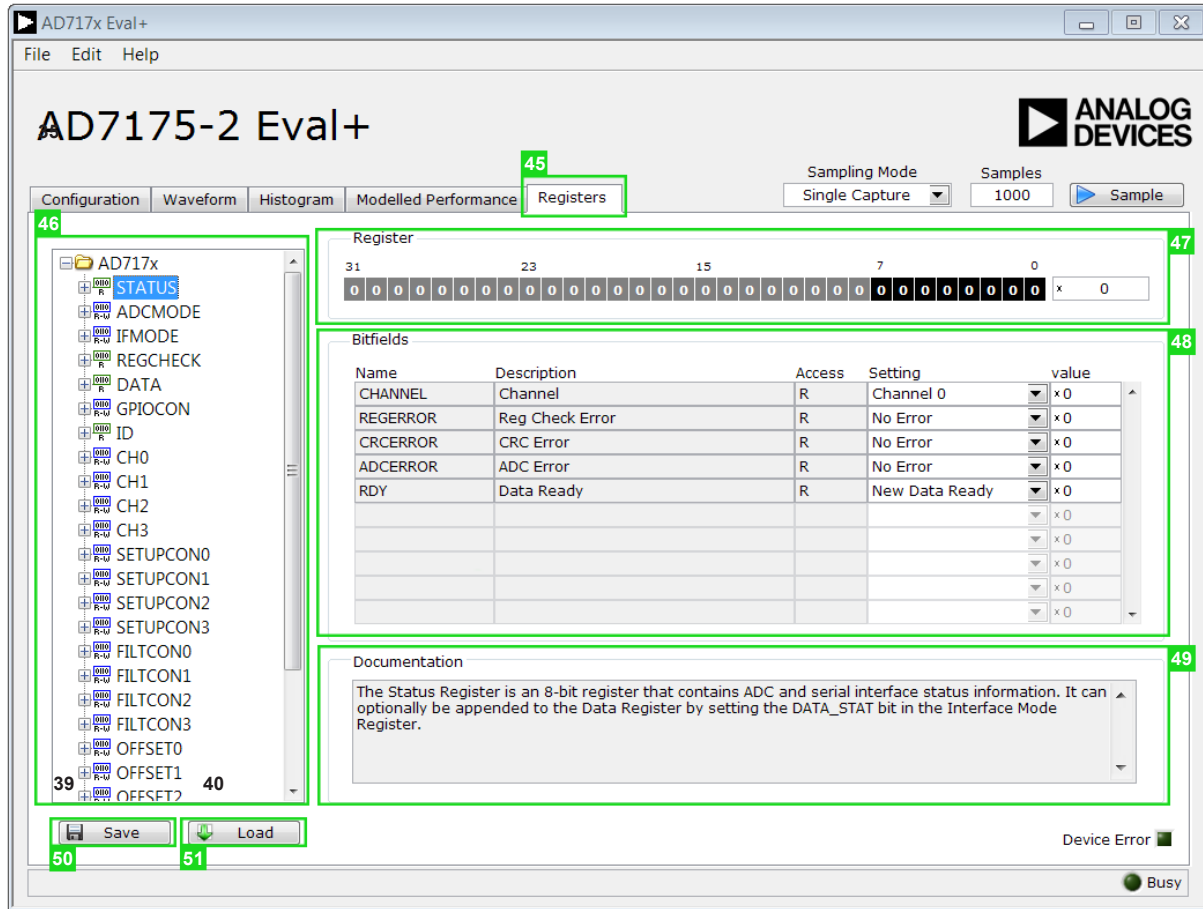

Figure 23. Registers Tab of the AD7175-2 Evaluation Software

REGISTERS TAB (45)

Figure 23 shows the Registers tab.

Register Tree (46)

This control shows the full register map in a tree control. Each register is shown; click the expand button next to each register to show all the bit fields contained within that register.

Register (47)

The Register control allows the user to change the individual bit of the register selected in the register tree (46) by clicking the bits or by programming the register value directly into the number control field on the right.

Bitfields (48)

This list shows all the bit fields of the register selected in the register tree (46). Change the values by using the drop-down box or by directly entering a value into the number control field on the right.

Documentation (49)

The Documentation field contains the documentation for the register or bitfield selected in the register tree (46).

Save(50) and Load (51)

The Save (50) and Load (51) buttons allow the user to save the current configuration of the AD7175-2 by saving off of the register map setting to a file and load the setting from that same file. When using these buttons the register configurations are saved and loaded as JSON files.

EXITING THE SOFTWARE

To exit the software, click the close button at the top right corner of the main window (see Figure 16).

EVALUATION BOARD SCHEMATICS AND ARTWORK

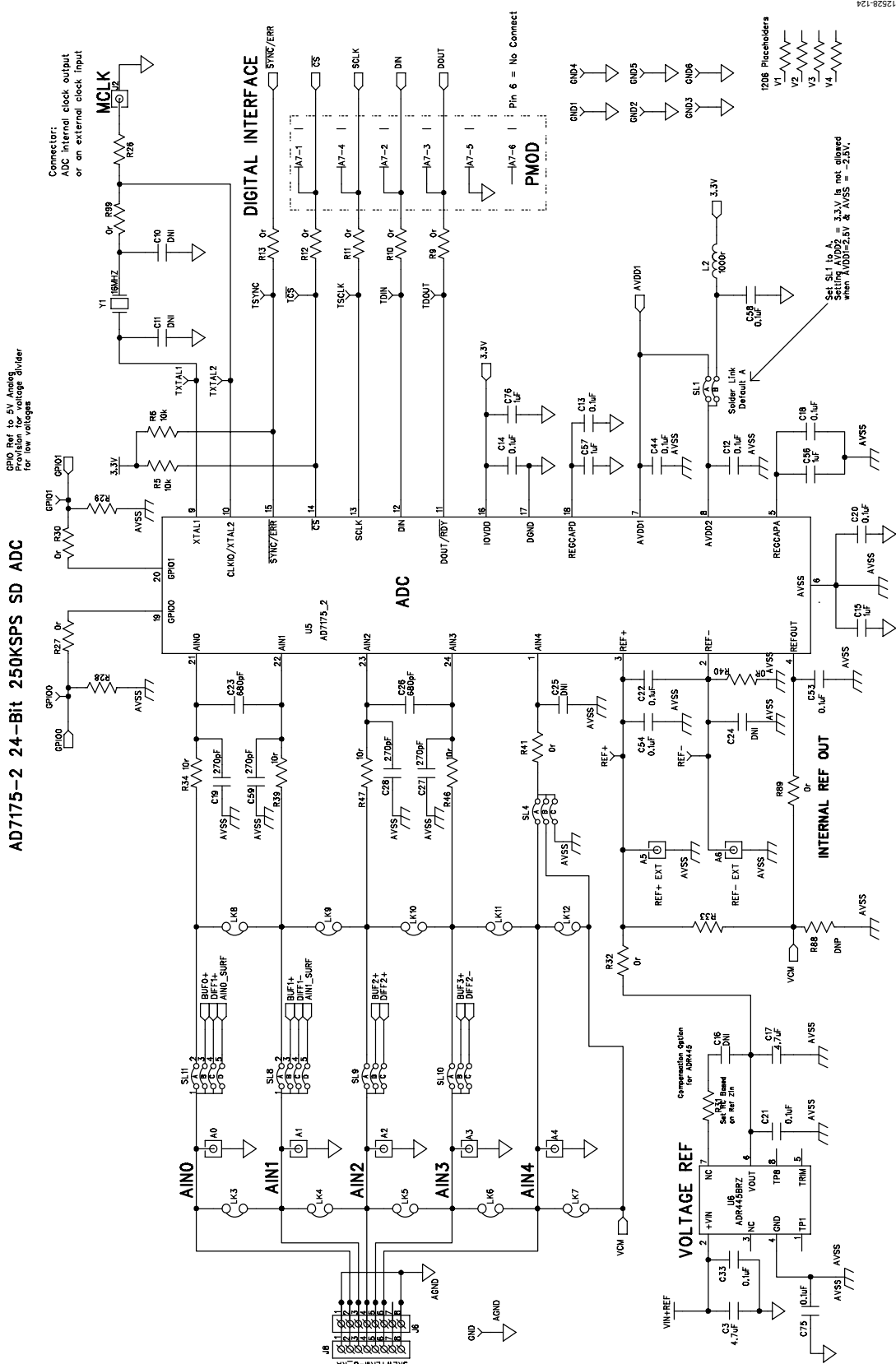

Figure 24. AD7175-2 Schematic

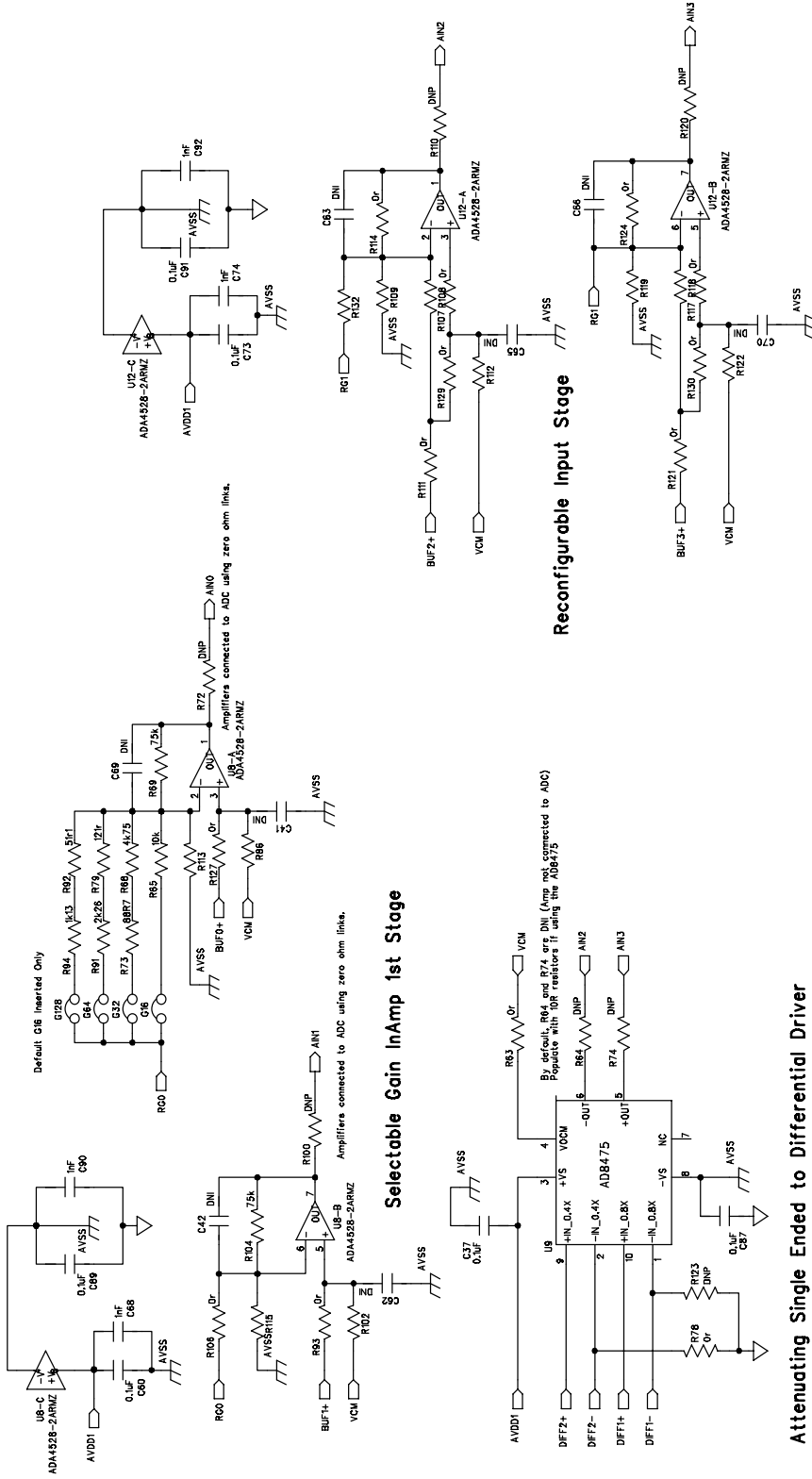
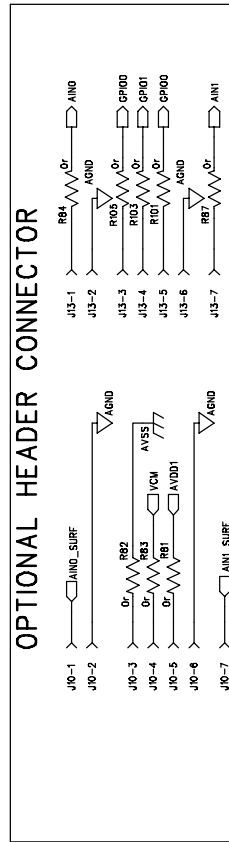

Figure 25. Amplifier Schematic

Attenuating Single Ended to Differential Driver



12528-126

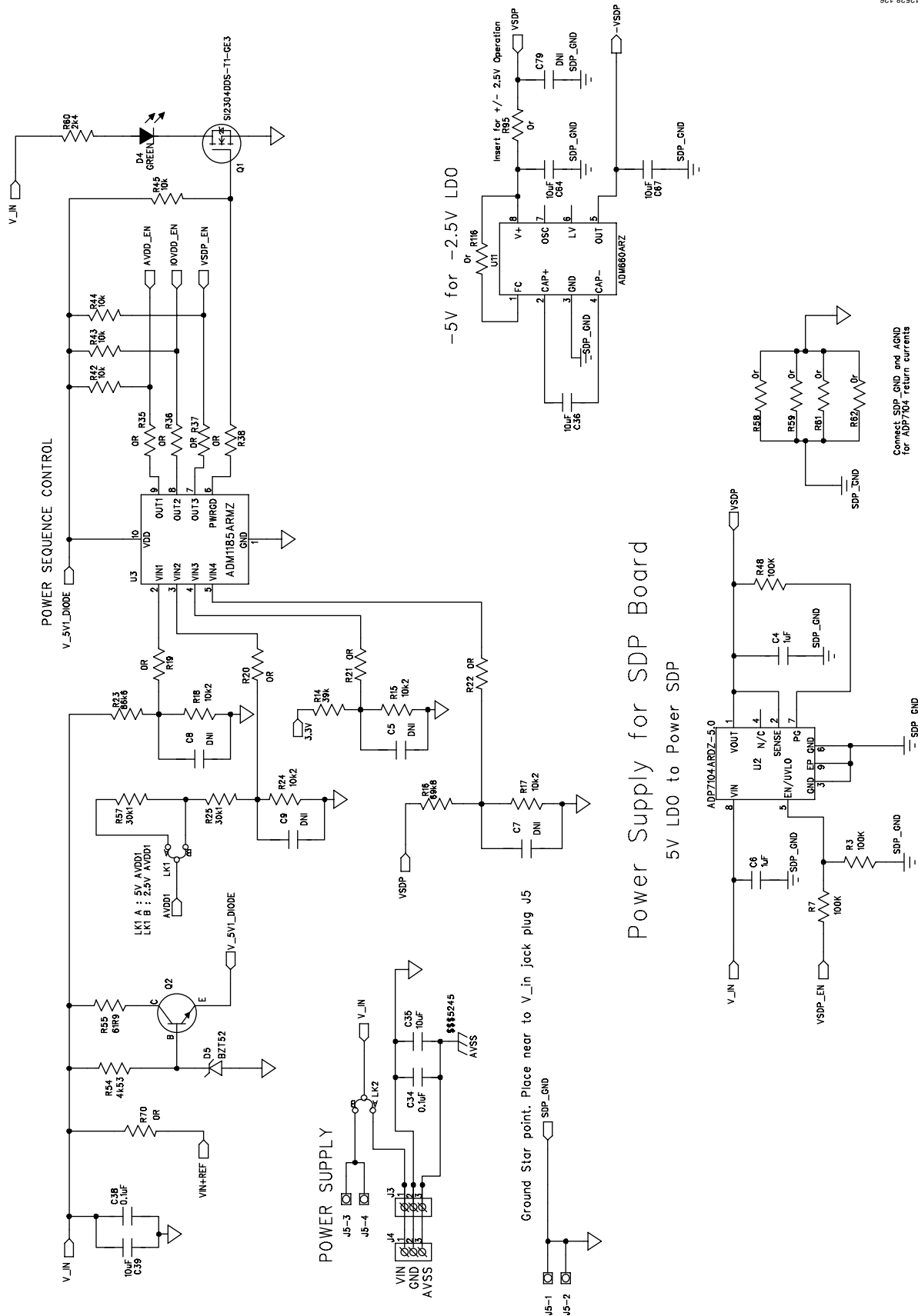

Figure 26. Power Supply Sequencing Schematic

5V, 3.3V & +/- 2.5V Regulators

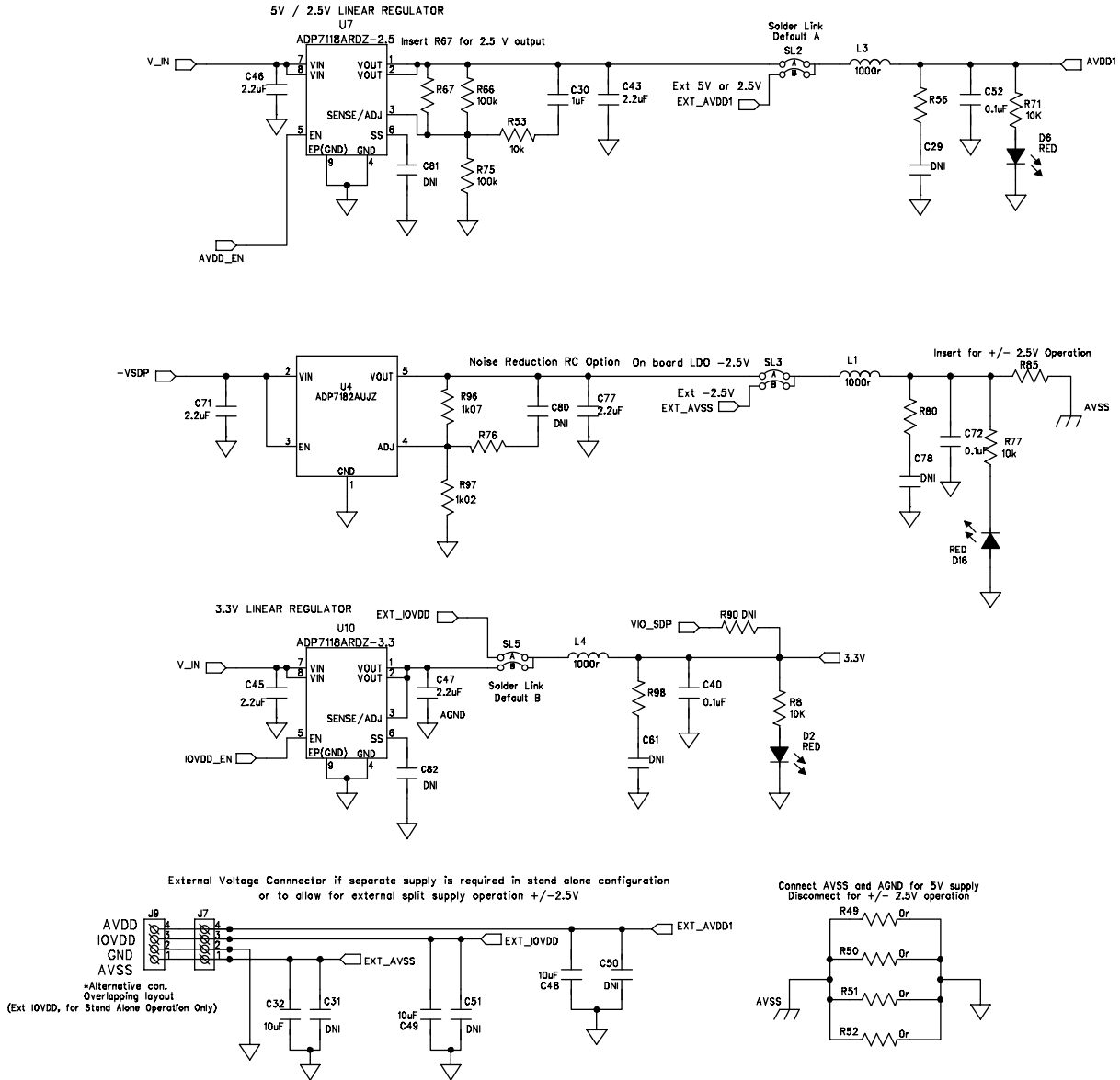

Figure 27. Regulator Schematic

12528-127

SDP CONNECTOR EEPROM-SW/USB ID

VIO: USE to set IO voltage max draw 20mA
 VIN: Use this pin to power the SDP requires 4-7V 200mA
 BMODE: Pull up with a 10K resistor to set SDP to boot from a SPI FLASH on the daughter board

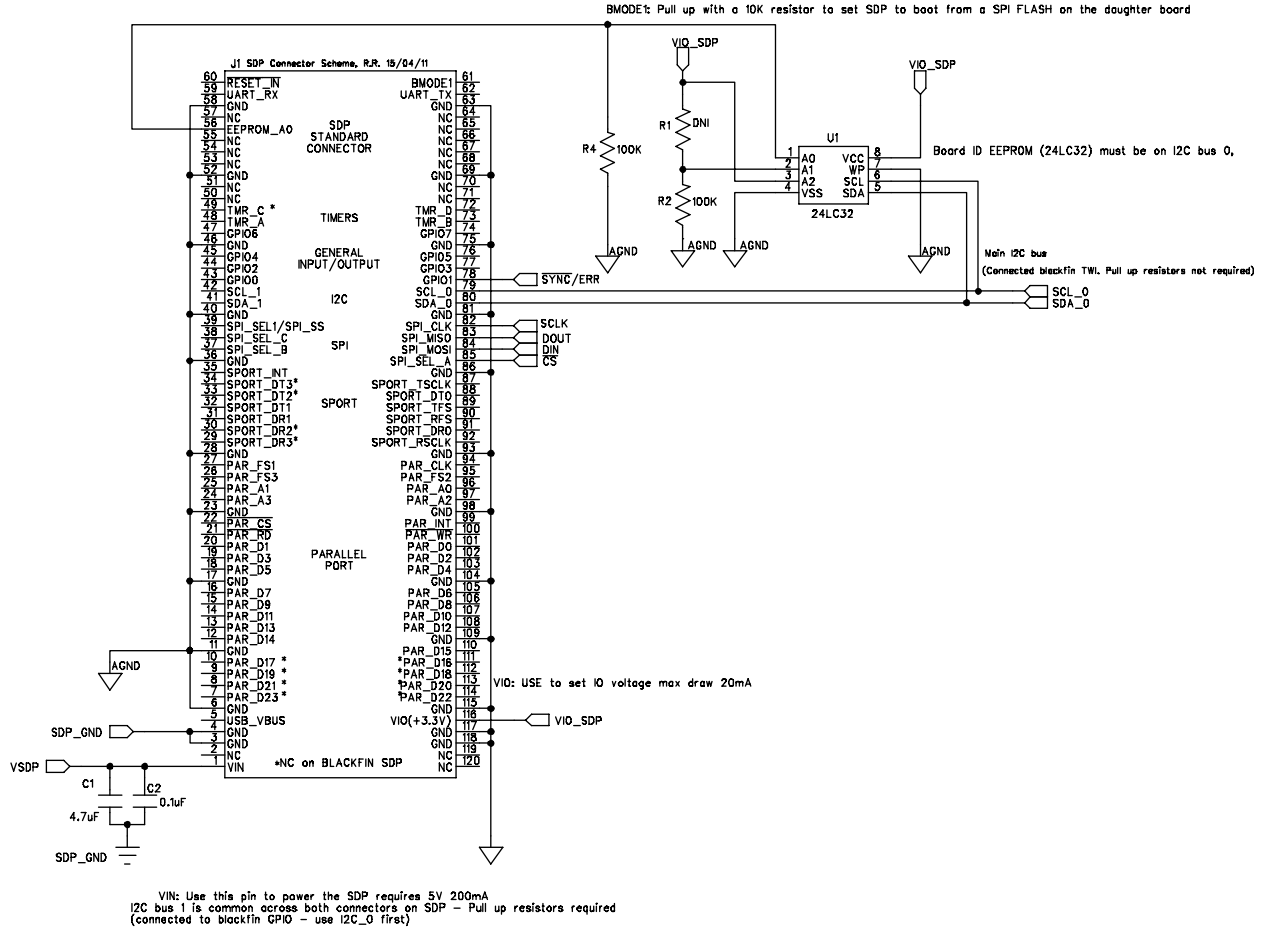

Figure 28. SDP-B Connector Schematic

12528-128

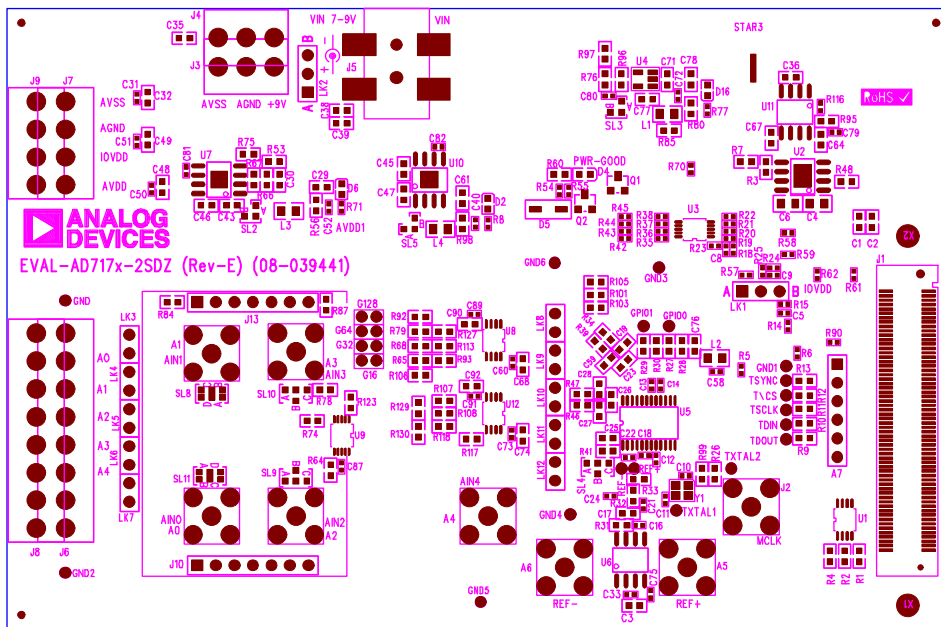

Figure 29. Top Printed Circuit Board (PCB) Silkscreen

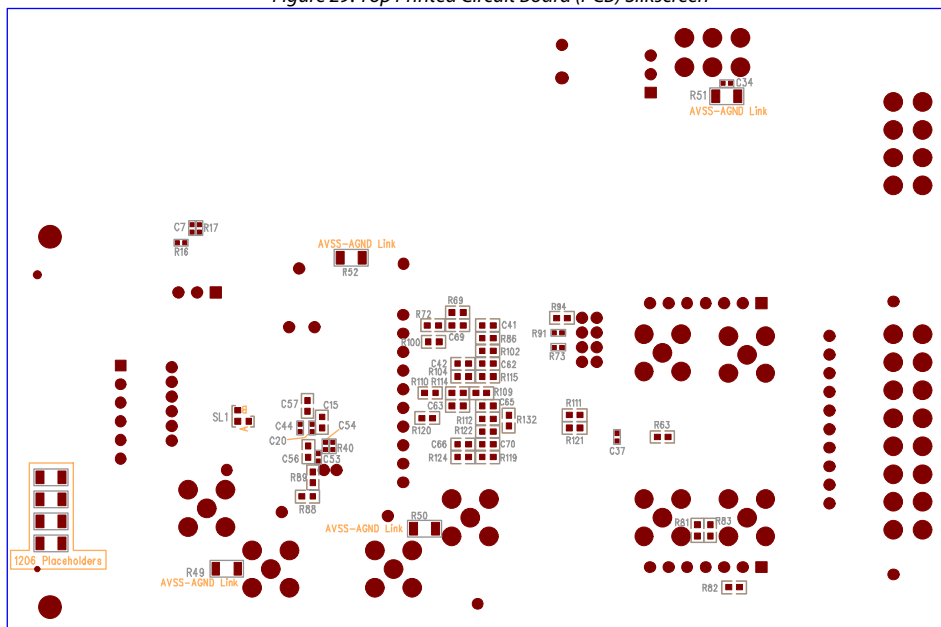

Figure 30. Bottom PCB Silkscreen

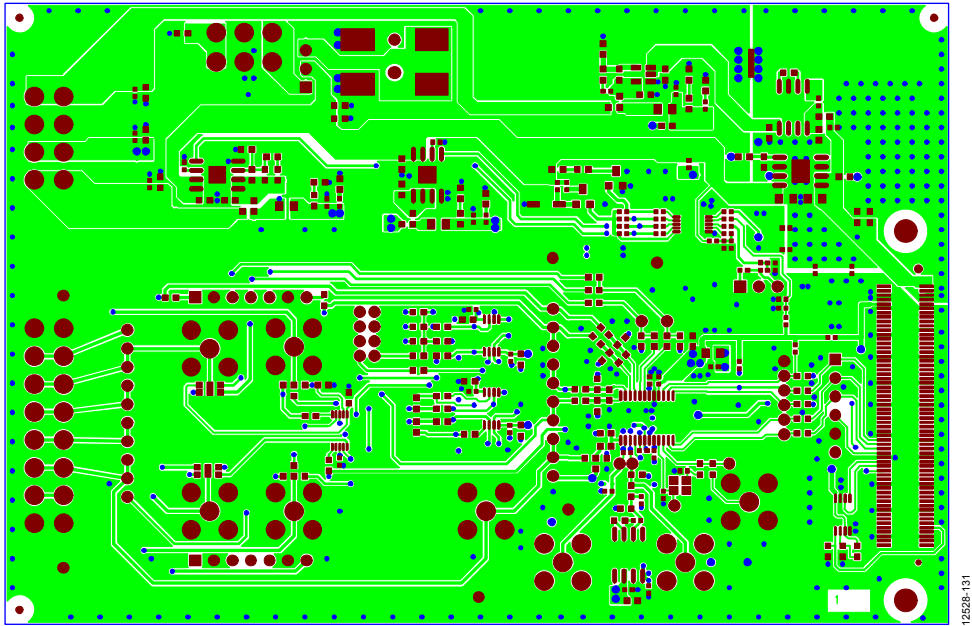

Figure 31. Layer 1 Component Side

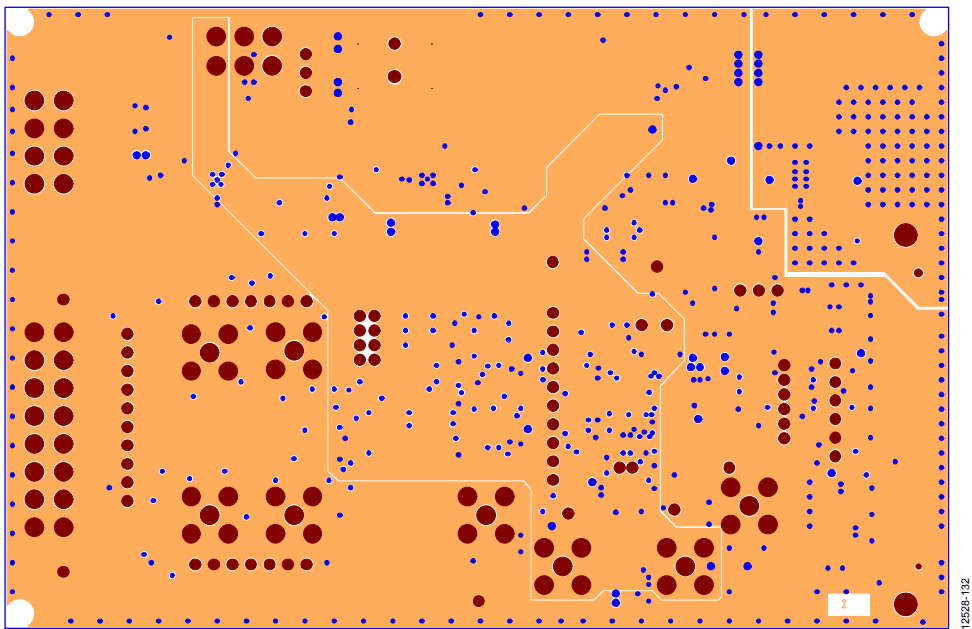
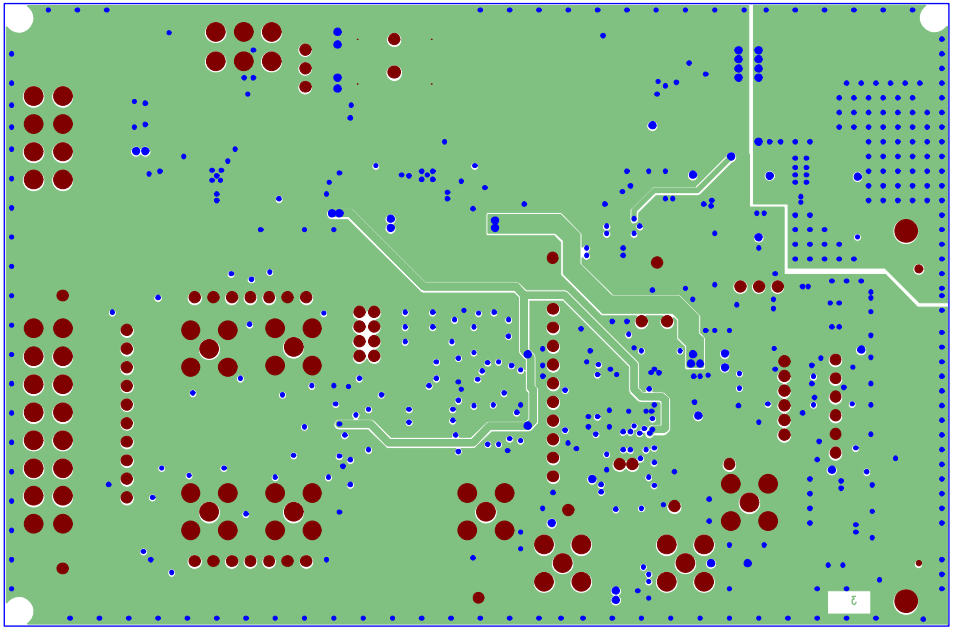
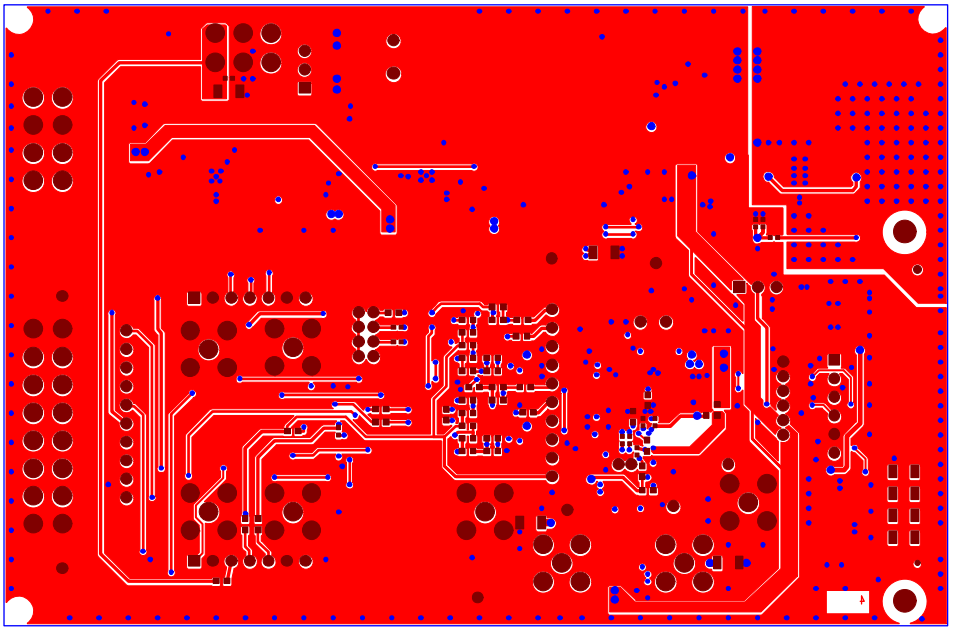

Figure 32. Layer 2 Ground Plane



12528-133

Figure 33. Layer 3 Power/Ground Plane



12528-134

Figure 34. Layer 4 Solder Side

ORDERING INFORMATION

BILL OF MATERIALS

Table 4.

Name	Part Description	Manufacturer	Part Number	Stock Code
A0 through A6	Straight PCB mount SMB jack, keep hole clear of solder. Do not insert.	TE Connectivity	1-1337482-0	Do not insert
A7	6-pin SIL header (0.1" pitch)	Harwin	20-9990646	FEC 1022255
C1, C17	Ceramic capacitor, 6.3 V, X5R, 0603, 4.7 µF	Murata	GRM188R60J475K	FEC 173-5527
C2, C38	Ceramic capacitor, 50 V, X7R, 0603, 0.1 µF	Murata	GRM188R71H104K	FEC 882-0023
C3	Ceramic capacitor, 10 V, X5R, 0603, 4.7 µF	KEMET Electronics Corp.	C0603C475K8PACTU	FEC 157-2625
C4, C6	Capacitor, 0805, 50 V, X7R, 1 µF	Murata	GRM21BR71H105KA12L	FEC 1735541
C5, C7 through C9, C16, C24 through C25, C29, C41 through C42, C61 through C63, C65 through C66, C69 through C70, C78 through C82	Ceramic capacitor, not inserted, 0402	Not applicable	Not applicable	Do not insert
C10, C11	Ceramic capacitor XTAL, not inserted, 0402	Not applicable	Not applicable	Do not insert
C12 through C14, C18, C20 through C22, C33 through C34, C37, C40, C44, C52 through C54, C58, C60, C72 through C73, C75, C87, C89, C91	Capacitor ceramic, 16 V, X7R, 0402	Murata	GRM155R71C104K	FEC 881-9742
C15, C30, C56 through C57, C76	Capacitor, 0603, 1 µF, 6.3 V	Murata	GRM188R70J105KA01D	FEC 184-5765
C19, C27 through C28, C55, C59, C83, C85 through C86	Ceramic capacitor, 50 V, C0G/NPO, 0603	AVX Corporation	06035A271JAT2A	FEC 1734627
C23, C26, C84, C88	Ceramic capacitor, 50 V, NPO, 0603	KEMET Electronics Corp.	C0603C681J5GACTU	FEC 1414648
C31, C50 through C51	Ceramic capacitor, 16 V, X7R, 0402, do not insert.	Not applicable	Not applicable	Do not insert
C32, C35 through C36, C39, C48 through C49, C64, C67	Capacitor, multilayer ceramic capacitor (MLCC) X5R, 10 µF, 10 V, 0603	TDK	C1608X5R1A106K080AC	FEC 221-1164
C43, C45 through C47, C71, C77	Capacitor, MLCC, X5R, 2.2 µF, 10V, 0603	MCM Electronics	MC0603X225K100CT	FEC 232-0817
C68, C74, C90, C92	50 V X7R MLCC	Yageo	2238 586 15623	FEC 722170
D2, D6, D16	Red LED, high intensity (>90 mCd), 0603	Broadcom Ltd.	HSMC-C191	FEC 855-4528
D4	LED, SMD green	Osram	LGQ971	FEC 1226372
D5	Zener Diode, 0.5 W, 5.1 V	Vishay	BZT52B5V1-V-GS08	FEC 1617767
G16	2-pin (2 mm pitch) header and shorting shunt	Harwin	M22-2010205 & M22-1920005	FEC 671915 and 510944
G32, G64, G128	2-pin (2 mm pitch) header	Harwin	M22-2010205	FEC 671915

Name	Part Description	Manufacturer	Part Number	Stock Code
GND, GND1 through GND6, GPIO0, GPIO1, REF+, REF-, TDIN, TDOUT, TERR, TCLK, TSYNC, TXTAL1, TXTAL2, TVCS	Test point, not inserted, keep hole clear of solder	Not applicable	Not applicable	Do not insert
J1	120-way connector, 0.6 mm pitch	HIROSE	FX8-120S-SV(21)	FEC 1324660
J2	Straight PCB mount SMB jack, keep hole clear of solder, do not insert	TE Connectivity	1-1337482-0	Do not insert
J3	Socket terminal block, 3.81 mm pitch	Phoenix Contact	MC 1.5/3-G-3.81	FEC 370-4737
J4	Screw terminal block, 3.81 mm pitch, do not insert	Phoenix Contact	1727023	Do not insert
J5	DC power connectors 2 mm SMT power jack	Lumberg	161314	FEC 1243245
J6	8-pin terminal header, 3.81 mm pitch, vertical	Phoenix Contact	MC 1,5/ 8-G-3,81	FEC 3704774
J7	Connector, pitch 3.81 mm, right angle	Phoenix Contact	MC 1,5/ 4-G-3,81 and 180-3594	Do not insert
J8	8-pin screw terminal, 3.81 mm pitch, vertical	Phoenix Contact	1727078	Do not insert
J9	Screw terminal block, 3.81 mm pitch	Phoenix Contact	1727036	FEC 370-4592
J10	7-way SSW 2.54 mm vertical socket (make sure to line up with connector on surf board)	Samtec	SSW-107-01-T-S	FEC 1803478
J11, J14	Screw terminal block, 3.81 mm pitch	Phoenix Contact	MKDS1/4-3.81	Do not insert.
J12	4-way power socket block, 3.81 mm pitch	Phoenix Contact	MC1.5/4-G-3.81	FEC 370-4749 and FEC 370-4920
J13	7-way SIP 2.54 mm TH Header (make sure to line up with connector on surf board)	Samtec	TLW-107-05-G-S	FEC 1668499
J15	4- way power socket block, 3.81 mm pitch	Phoenix Contact	MC1.5/4-G-3.81	FEC 370-4749 and FEC 370-4920
L1 through L4	Ferrite bead, 0.3 Ω at dc, 1000 Ω at 100 MHz, 350 mA, 0805	TE Connectivity	BMB2A1000LN2	FEC 119-3421
LK1 through LK2	3 pin (3 \times 1) 0.1" header and shorting block in A	Harwin	M20-9990346 & M7566-05	FEC 1022249 and 150-411
LK3 through LK7	2-pin (0.1" pitch) header	Harwin	M20-9990246	FEC 1022247
LK8 through LK12	2-pin (0.1" pitch) header and shorting shunt	Harwin	M20-9990246	FEC 1022247 and 150-411
Q1	SI2304DDS-T1-GE3 MOSFET, N CH, 30 V, 3.6 A, diode, SOT-23	Vishay	SI2304DDS-T1-GE3	FEC 1858939
Q2	Transistor, NPN, SOT-23	ON Semiconductor	MMBT3904LT1G	FEC 1459100
R1	Resistor, not inserted, 0603	Not applicable	Not applicable	Do not insert.
R2 through R4, R7, R48, R66, R75	Resistor, 100 K, 0.063 W, 1%, 0603	MCM Electronics	MC0063W06031100K	FEC 9330402
R5, R6, R77	Resistor, 10 K, 0.063 W, 1 %, 0402	MCM Electronics	MC00625W0402110K	FEC 1358069
R8, R71	Resistor, 1 %, 0402	Yageo	CRCW040210K0FKEAHP	FEC 173-8864

Name	Part Description	Manufacturer	Part Number	Stock Code
R9 through R13, R27, R30, R32, R41, R63, R78, R81 through R84, R87, R95, R99, R101, R103, R105, R107, R111, R114, R117, R121, R124, R128 through R131	Resistor, 0603 1 % 0R	MCM Electronics	MC0063W06030R	FEC 9331662
R14	Resistor, 0402, 1 %, 39 K	MCM Electronics	MC 0.0625W 0402 1% 39K	FEC 1358085
R15, R17, R18, R24	SMD Resistor	MCM Electronics	MC 0.0625W 0402 1% 10K2	FEC 1803137
R16	Resistor, 0402, 1 %, 69K8	MCM Electronics	MC 0.0625W 0402 1% 69K8	FEC 1803735
R19 through R22, R35 through R38, R40, R58, R59, R61, R62, R70, R116	Resistor, 0402	Vishay	CRCW04020000Z0ED	FEC 146-9661
R23	Resistor, 0402, 1 %, 86K6	MCM Electronics	MC 0.0625W 0402 1% 86K6	FEC 1803744
R25, R57	Resistor, 0402, 1 %, 30k1	MCM Electronics	MC 0.0625W 0402 1% 30k1	FEC 1803699
R26, R28, R29, R31, R33, R56, R64, R67, R72, R74, R76, R80, R85, R86, R88, R98, R100, R102, R108 through R110, R112, R113, R115, R118 through R120, R122, R123, R125, R126, R132, R34, R39, R46, R47	SMD Resistor 0603	Not applicable	Not applicable	Do Not Insert
R42 through R45	Resistor, Thick Film, 10 kΩ, 62.5 mW, 5 %	Yageo	RC0402JR-1310KL	FEC 179-9316
R49 through R52	Resistor, 1206	MCM Electronics	MC 0.125W 1206 0R	FEC 9336974
R53, R65	Resistor, 10 K, 0.063 W, 1 %, 0603	MCM Electronics	MC0063W0603110K	FEC 9330399
R54	Resistor, Thick Film, 4.53 kΩ, 63 mW, 1 %	Vishay	CRCW04024K53FKED	FEC 1151244
R55	Resistor, 0402, 1 %, 61R9	MCM Electronics	MC 0.0625W 0402 1% 61R9	FEC 1802915
R60	Resistor, Thick Film, 2.4 kΩ, 0603, 100 mW, 1 %	Yageo	RC0603FR-072K4L	FEC 1799329
R68	Resistor, 0603, 4K75, 0.1 %, 0.1 W	Panasonic	ERA3ARB4751V	FEC 209-4611
R69, R104	Resistor, 0603, 0.1 %, 0.1 W, 75K	Panasonic	ERA3ARB753P	FEC 171-7620
R73	Resistor, 88R7, 0.063 W, 0.1 %, 0402	TE Connectivity	RN73C1E88R7B	FEC 173-7900
R79	Resistor, 121R, 0.063 W, 0.1 %, 0603	TE Connectivity/ Holsworthy	RN73C1J121RBTG	FEC 114-0465
R90	Resistor, not inserted, 0402	Not applicable	Not applicable	Do Not Insert
R91	Resistor, 2K26, 0.063 W, 0.1 %, 0402	TE Connectivity	RN73C1E2K26B	FEC 173-8050
R92	Resistor, 51R1, 0.063 W, 0.1 %, 0603	TE Connectivity/ Holsworthy	RN73C1J51R1BTG	FEC 114-0446
R93, R106	Resistor, 0603	Vishay	CRCW06030000Z0EA	FEC 146-9739
R94	Resistor, 0603, 1K13, 0.1 %, 0.1 W	Panasonic	ERA3ARB1131V	FEC 209-4485

Name	Part Description	Manufacturer	Part Number	Stock Code
R96	Resistor, 1K07, 0.063 W, 1 %, 0603	MCM Electronics	MC0063W060311K07	FEC 1170792
R97	Resistor, 1K02, 0.063 W, 1 %, 0603	MCM Electronics	MC0063W060311K02	FEC 1170789
R127	Resistor, 0603	Vishay	CRCW06030000Z0EA	FEC 146-9739
SL1	2-way Resistor Link Option	MCM Electronics	MC 0.063W 0603 0R	FEC 9331662
SL2, SL3	2-way Solder Link (Use Or 0603 Resistor)	Not applicable	Insert in Link Position "A"	FEC 933-1662
SL4	3-way Solder Link (Use Or 0603 Resistor)	Not applicable	Insert in Link Position "C"	FEC 933-1662
SL5	2-way Solder Link (Use Or 0603 Resistor)	Not applicable	Insert in Link Position "B"	FEC 933-1662
SL8	4-way Solder Link (Use Or 0603 Resistor)	Not applicable	Insert in Link Position "A"	FEC 933-1662
SL9, SL10	3-way Solder Link (Use Or 0603 Resistor)	Not applicable	Insert in Link Position "A"	FEC 933-1662
SL11	4-way Solder Link (Use Or 0603 Resistor)	Not applicable	Insert in Link Position "A"	FEC 933-1662
STAR3	Ground Link (Copper Short)	Not applicable	Not applicable	Not applicable
U1	32 K I ² C Serial EEPROM	Microchip Technology Inc.	24LC32A-I/MS	FEC1331330
U2	Linear Regulator 5 V, 20 V, 500 mA, Ultralow Noise, CMOS	Analog Devices, Inc.	ADP7104ARDZ-5.0	ADP7104ARDZ-5.0
U3	Quad Voltage Monitor and Sequencer	Analog Devices, Inc.	ADM1185ARMZ-1	ADM1185ARMZ-1
U4	8 V, –200 mA, Low Noise, Linear Regulator	Analog Devices, Inc.	ADP7182AUJZ	ADP7182AUJZ-R7
U5	ADC	Analog Devices, Inc.	AD7175-2BRUZ	AD7175-2BRUZ
U6	5 V XFET Reference	Analog Devices, Inc.	ADR445BRZ	ADR445BRZ
U7	Linear Regulator 2.5 V, Ultralow Noise, CMOS	Analog Devices, Inc.	ADP7118ARDZ-2.5	ADP7118ARDZ-2.5-R7
U8	5.0 V Ultralow Noise, Zero-Drift, RRIO, Dual Op-Amp	Analog Devices, Inc.	ADA4528-2ARMZ	ADA4528-2ARMZ
U9	Fully Differential Funnel Amplifier	Analog Devices, Inc.	AD8475ARMZ	AD8475ARMZ
U10	Linear Regulator 3.3 V, Ultralow Noise, CMOS	Analog Devices, Inc.	ADP7118ARDZ-3.3	ADP7118ARDZ-3.3-R7
U11	CMOS Switched-Capacitor Voltage Converter	Analog Devices, Inc.	ADM660ARZ	ADM660ARZ
U12	5.0 V Ultralow Noise, Zero-Drift, RRIO, Dual Op-Amp	Analog Devices, Inc.	ADA4528-2ARMZ	ADA4528-2ARMZ
V1 through V4	1206 Place Holder	Not applicable	Not applicable	Do Not Insert
Y1	Miniature Crystal SMD	Epson	FA-20H, 16 MHz, 10 PPM, 9 PF	FEC 171-2814

NOTES

I²C refers to a communications protocol originally developed by Philips Semiconductors (now NXP Semiconductors).



ESD Caution

ESD (electrostatic discharge) sensitive device. Charged devices and circuit boards can discharge without detection. Although this product features patented or proprietary protection circuitry, damage may occur on devices subjected to high energy ESD. Therefore, proper ESD precautions should be taken to avoid performance degradation or loss of functionality.

Legal Terms and Conditions

By using the evaluation board discussed herein (together with any tools, components documentation or support materials, the "Evaluation Board"), you are agreeing to be bound by the terms and conditions set forth below ("Agreement") unless you have purchased the Evaluation Board, in which case the Analog Devices Standard Terms and Conditions of Sale shall govern. Do not use the Evaluation Board until you have read and agreed to the Agreement. Your use of the Evaluation Board shall signify your acceptance of the Agreement. This Agreement is made by and between you ("Customer") and Analog Devices, Inc. ("ADI"), with its principal place of business at One Technology Way, Norwood, MA 02062, USA. Subject to the terms and conditions of the Agreement, ADI hereby grants to Customer a free, limited, personal, temporary, non-exclusive, non-sublicensable, non-transferable license to use the Evaluation Board FOR EVALUATION PURPOSES ONLY. Customer understands and agrees that the Evaluation Board is provided for the sole and exclusive purpose referenced above, and agrees not to use the Evaluation Board for any other purpose. Furthermore, the license granted is expressly made subject to the following additional limitations: Customer shall not (i) rent, lease, display, sell, transfer, assign, sublicense, or distribute the Evaluation Board; and (ii) permit any Third Party to access the Evaluation Board. As used herein, the term "Third Party" includes any entity other than ADI, Customer, their employees, affiliates and in-house consultants. The Evaluation Board is NOT sold to Customer; all rights not expressly granted herein, including ownership of the Evaluation Board, are reserved by ADI. CONFIDENTIALITY. This Agreement and the Evaluation Board shall all be considered the confidential and proprietary information of ADI. Customer may not disclose or transfer any portion of the Evaluation Board to any other party for any reason. Upon discontinuation of use of the Evaluation Board or termination of this Agreement, Customer agrees to promptly return the Evaluation Board to ADI. ADDITIONAL RESTRICTIONS. Customer may not disassemble, decompile or reverse engineer chips on the Evaluation Board. Customer shall inform ADI of any occurred damages or any modifications or alterations it makes to the Evaluation Board, including but not limited to soldering or any other activity that affects the material content of the Evaluation Board. Modifications to the Evaluation Board must comply with applicable law, including but not limited to the RoHS Directive. TERMINATION. ADI may terminate this Agreement at any time upon giving written notice to Customer. Customer agrees to return to ADI the Evaluation Board at that time. LIMITATION OF LIABILITY. THE EVALUATION BOARD PROVIDED HEREUNDER IS PROVIDED "AS IS" AND ADI MAKES NO WARRANTIES OR REPRESENTATIONS OF ANY KIND WITH RESPECT TO IT. ADI SPECIFICALLY DISCLAIMS ANY REPRESENTATIONS, ENDORSEMENTS, GUARANTEES, OR WARRANTIES, EXPRESS OR IMPLIED, RELATED TO THE EVALUATION BOARD INCLUDING, BUT NOT LIMITED TO, THE IMPLIED WARRANTY OF MERCHANTABILITY, TITLE, FITNESS FOR A PARTICULAR PURPOSE OR NON-INFRINGEMENT OF INTELLECTUAL PROPERTY RIGHTS. IN NO EVENT WILL ADI AND ITS LICENSORS BE LIABLE FOR ANY INCIDENTAL, SPECIAL, INDIRECT, OR CONSEQUENTIAL DAMAGES RESULTING FROM CUSTOMER'S POSSESSION OR USE OF THE EVALUATION BOARD, INCLUDING BUT NOT LIMITED TO LOST PROFITS, DELAY COSTS, LABOR COSTS OR LOSS OF GOODWILL. ADI'S TOTAL LIABILITY FROM ANY AND ALL CAUSES SHALL BE LIMITED TO THE AMOUNT OF ONE HUNDRED US DOLLARS (\$100.00). EXPORT. Customer agrees that it will not directly or indirectly export the Evaluation Board to another country, and that it will comply with all applicable United States federal laws and regulations relating to exports. GOVERNING LAW. This Agreement shall be governed by and construed in accordance with the substantive laws of the Commonwealth of Massachusetts (excluding conflict of law rules). Any legal action regarding this Agreement will be heard in the state or federal courts having jurisdiction in Suffolk County, Massachusetts, and Customer hereby submits to the personal jurisdiction and venue of such courts. The United Nations Convention on Contracts for the International Sale of Goods shall not apply to this Agreement and is expressly disclaimed.

©2014–2018 Analog Devices, Inc. All rights reserved. Trademarks and registered trademarks are the property of their respective owners.
UG12528-0-1/18(B)



www.analog.com



Компания «ЭлектроПласт» предлагает заключение долгосрочных отношений при поставках импортных электронных компонентов на взаимовыгодных условиях!

Наши преимущества:

- Оперативные поставки широкого спектра электронных компонентов отечественного и импортного производства напрямую от производителей и с крупнейших мировых складов;
- Поставка более 17-ти миллионов наименований электронных компонентов;
- Поставка сложных, дефицитных, либо снятых с производства позиций;
- Оперативные сроки поставки под заказ (от 5 рабочих дней);
- Экспресс доставка в любую точку России;
- Техническая поддержка проекта, помощь в подборе аналогов, поставка прототипов;
- Система менеджмента качества сертифицирована по Международному стандарту ISO 9001;
- Лицензия ФСБ на осуществление работ с использованием сведений, составляющих государственную тайну;
- Поставка специализированных компонентов (Xilinx, Altera, Analog Devices, Intersil, Interpoint, Microsemi, Aeroflex, Peregrine, Syfer, Eurofarad, Texas Instrument, Miteq, Cobham, E2V, MA-COM, Hittite, Mini-Circuits, General Dynamics и др.);

Помимо этого, одним из направлений компании «ЭлектроПласт» является направление «Источники питания». Мы предлагаем Вам помощь Конструкторского отдела:

- Подбор оптимального решения, техническое обоснование при выборе компонента;
- Подбор аналогов;
- Консультации по применению компонента;
- Поставка образцов и прототипов;
- Техническая поддержка проекта;
- Защита от снятия компонента с производства.



Как с нами связаться

Телефон: 8 (812) 309 58 32 (многоканальный)

Факс: 8 (812) 320-02-42

Электронная почта: org@eplast1.ru

Адрес: 198099, г. Санкт-Петербург, ул. Калинина, дом 2, корпус 4, литера А.