

Compact EMC/EMI Filter for the Control Line of Equipment



- Filter for the control line of complex equipment and machinery
- Ensures the interference-free operation of the control unit / PLC
- Improves the immunity and reliability of the entire system
- Compact EMC filter design with minimum space requirement



Performance indicators

Attenuation performance



Rated current [A]

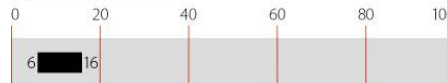

Technical specifications

Maximum continuous operating voltage	250 VAC (230 VAC +10% possible)
Operating frequency	dc to 60 Hz
Rated currents	6 to 16 A @ 50 °C
High potential test voltage	P/N → E 2250 VDC for 2 sec P → N 1100 VDC for 2 sec
Protection category	IP20
Overload capability	4x rated current at switch on, 1.5x rated current for 1 minute, once per hour
Temperature range (operation and storage)	-25 °C to +100 °C (25/100/21)
Flammability corresponding to	UL 94 V-2 or better
Design corresponding to	UL 1283, CSA 22.2 No. 8 1986, IEC/EN 60939
MTBF @ 50°C/230V (Mil-HB-217F)	>1,300,000 hours

Approvals



Features and benefits

- An additional filter for the supply cables of controls of rather large and complex systems, to ensure a fault free operation of the control unit (PLC, Motion Control etc.)
- Improves the immunity, reliability and service security of the entire system significant by reducing the risk of internal interference propagation and coupling
- Improves the immunity, reliability and service security of the entire system significant by reducing the risk of internal interference propagation and coupling
- Simple and time-saving installation with good accessibility for automatic and hand tools
- Solid, touch-safe terminal blocks offering sufficient contacting cross section according to the EN 60204-1 installation standard, which is very common for machine tools and industrial equipment
- By providing a very decent attenuation performance, FN 2415 contributes significant to the achievement of electromagnetic compliance according to the last standards (like EN 50370-1 for machine tools)

Typical applications

Ideal for industrial equipment, machinery and diverse process automation systems, which involve any kind of control units (NC, CNC, PLC, Motion Controls). Rather large and complex machine tools, with 8 or even more driving axes and very long motor cables, can be subjected to major reliability problems, caused by internal coupling of interferences from the drive system to the control lines. Very often, this causes a drop out of the control unit and consequently downtimes of the entire machine. By operating an FN 2415 in addition to a mains input filter, these negative effects can be eliminated for most situations. FN 2415 can also be used for the most diverse single-phase applications with medium to high interference levels, such as single-phase motor drives or power supplies.

Typical electrical schematic

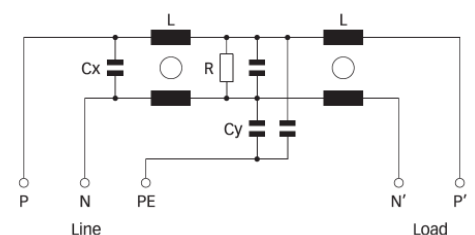

Filter selection table

Filter	Rated current @ 50 °C (40 °C) [A]	Leakage current* @ 250 VAC/50 Hz [mA]	Power loss @ 25 °C/50 Hz [W]	Input/Output connections 	Weight [kg]
FN 2415-6-29	6 (6.6)	9.4	2.2	-29	0.4
FN 2415-10-29	10 (11)	9.4	2.4	-29	0.4
FN 2415-16-29	16 (17.5)	9.4	4.3	-29	0.4

* Maximum leakage under normal operating conditions. Note: if the neutral line is interrupted, worst case leakage could reach twice this level.

Typical filter attenuation

Per CISPR 17; A = 50 Ω/50 Ω sym; B = 50 Ω/50 Ω asym; C = 0.1 Ω/100 Ω sym; D = 100 Ω/0.1 Ω sym

6 A types

10 A types

16 A types

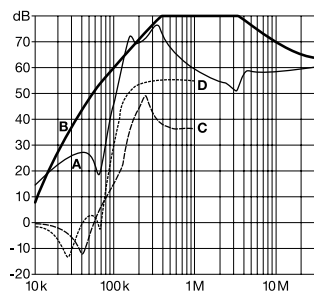
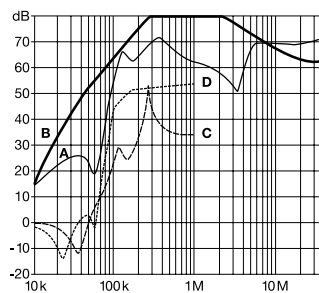
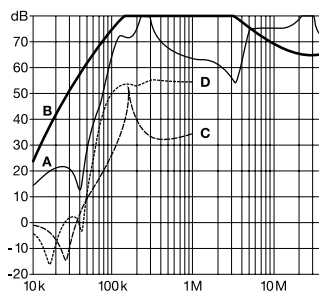

Mechanical data

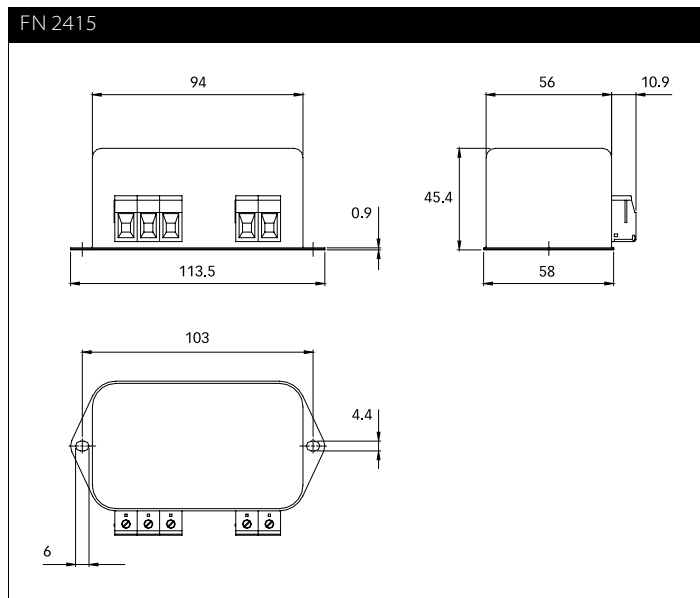

All dimensions in mm, 1 inch = 25.4 mm
Tolerances according: ISO 2768-m / EN 22768-m

Filter input/output connector cross sections

	 -29
Solid wire	6 mm ²
Flex wire	4 mm ²
AWG type wire	AWG 10
Recommended torque	0.6-0.8 Nm

Please visit www.schaffner.com to find more details on filter connectors.



Компания «ЭлектроПласт» предлагает заключение долгосрочных отношений при поставках импортных электронных компонентов на взаимовыгодных условиях!

Наши преимущества:

- Оперативные поставки широкого спектра электронных компонентов отечественного и импортного производства напрямую от производителей и с крупнейших мировых складов;
- Поставка более 17-ти миллионов наименований электронных компонентов;
- Поставка сложных, дефицитных, либо снятых с производства позиций;
- Оперативные сроки поставки под заказ (от 5 рабочих дней);
- Экспресс доставка в любую точку России;
- Техническая поддержка проекта, помощь в подборе аналогов, поставка прототипов;
- Система менеджмента качества сертифицирована по Международному стандарту ISO 9001;
- Лицензия ФСБ на осуществление работ с использованием сведений, составляющих государственную тайну;
- Поставка специализированных компонентов (Xilinx, Altera, Analog Devices, Intersil, Interpoint, Microsemi, Aeroflex, Peregrine, Syfer, Eurofarad, Texas Instrument, Miteq, Cobham, E2V, MA-COM, Hittite, Mini-Circuits, General Dynamics и др.);

Помимо этого, одним из направлений компании «ЭлектроПласт» является направление «Источники питания». Мы предлагаем Вам помощь Конструкторского отдела:

- Подбор оптимального решения, техническое обоснование при выборе компонента;
- Подбор аналогов;
- Консультации по применению компонента;
- Поставка образцов и прототипов;
- Техническая поддержка проекта;
- Защита от снятия компонента с производства.



Как с нами связаться

Телефон: 8 (812) 309 58 32 (многоканальный)

Факс: 8 (812) 320-02-42

Электронная почта: org@eplast1.ru

Адрес: 198099, г. Санкт-Петербург, ул. Калинина, дом 2, корпус 4, литера А.