

NPN PRE-BIASED SMALL SIGNAL SOT23 SURFACE MOUNT TRANSISTOR
Product Summary

| Part Number | R1 (NOM) | R2 (NOM) |
|-------------|----------|----------|
| DDTC113ZCA | 1KΩ | 10KΩ |
| DDTC123YCA | 2.2KΩ | 10KΩ |
| DDTC123JCA | 2.2KΩ | 47KΩ |
| DDTC143XCA | 4.7KΩ | 10KΩ |
| DDTC143FCA | 4.7KΩ | 22KΩ |
| DDTC143ZCA | 4.7KΩ | 47KΩ |
| DDTC114YCA | 10KΩ | 47KΩ |
| DDTC114WCA | 10KΩ | 4.7KΩ |
| DDTC124XCA | 22KΩ | 47KΩ |
| DDTC144VCA | 47KΩ | 10KΩ |
| DDTC144WCA | 47KΩ | 22KΩ |

Features and Benefits

- Epitaxial Planar Die Construction
- Complementary PNP Types Available (DDTA)
- Built-In Biasing Resistors, R1≠R2
- “Lead Free”, RoHS Compliant (Note 1)
- Halogen and Antimony Free “Green” Device (Note 2)
- Qualified to AEC-Q101 Standards for High Reliability

Mechanical Data

- Case: SOT23
- Case material: Molded Plastic. “Green” Molding Compound.
- Classification Rating 94V-0
- Moisture Sensitivity: Level 1 per J-STD-020
- Terminals: Matte Tin Finish
- Weight: 0.008 grams (approximate)

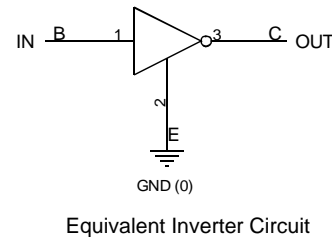
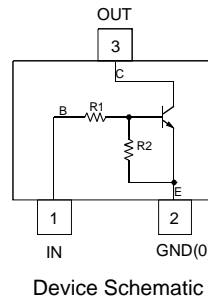
Ordering Information (Notes 3 & 4)

| Product | Grade | Marking | Reel size (inches) | Tape width (mm) | Quantity per reel |
|------------------|------------|---------|--------------------|-----------------|-------------------|
| DDTC113ZCA-7-F | Commercial | N02 | 7 | 8 | 3,000 |
| DDTC123YCA-7-F | Commercial | N05 | 7 | 8 | 3,000 |
| DDTC123JCA-7-F | Commercial | N06 | 7 | 8 | 3,000 |
| DDTC143XCA-7-F | Commercial | N09 | 7 | 8 | 3,000 |
| DDTC143FCA-7-F | Commercial | N10 | 7 | 8 | 3,000 |
| DDTC143ZCA-7-F | Commercial | N11 | 7 | 8 | 3,000 |
| DDTC143ZCAQ-7-F | Automotive | N11 | 7 | 8 | 3,000 |
| DDTC143ZCAQ-13-F | Automotive | N11 | 13 | 8 | 10,000 |
| DDTC114YCA-7-F | Commercial | N14 | 7 | 8 | 3,000 |
| DDTC114YCAQ-7-F | Automotive | N14 | 7 | 8 | 3,000 |
| DDTC114YCAQ-13-F | Automotive | N14 | 13 | 8 | 10,000 |
| DDTC114WCA-7-F | Commercial | N15 | 7 | 8 | 3,000 |
| DDTC124XCA-7-F | Commercial | N18 | 7 | 8 | 3,000 |
| DDTC144VCA-7-F | Commercial | N21 | 7 | 8 | 3,000 |
| DDTC144WCA-7-F | Commercial | N22 | 7 | 8 | 3,000 |

- Notes:
1. No purposefully added lead.
 2. Diodes Inc's "Green" policy can be found on our website at <http://www.diodes.com>.
 3. For packaging details, go to our website at <http://www.diodes.com>.
 4. Products with Q-suffix are automotive grade. Automotive products are electrical and thermal the same as the commercial, except where specified.

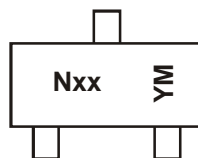
Marking Information

Nxx = Product Type Marking Code (See Table Above)
 YM = Date Code Marking
 Y = Year (ex: T = 2006)
 M = Month (ex: 9 = September)

Date Code Key

| Year Code | 2002 | 2003 | 2004 | 2005 | 2006 | 2007 | 2008 | 2009 | 2010 | 2011 | 2012 | 2013 | 2014 | 2015 | 2016 | 2017 |
|-----------|------|------|------|------|------|------|------|------|------|------|------|------|------|------|------|------|
| | N | P | R | S | T | U | V | W | X | Y | Z | A | B | C | D | E |

| Month Code | Jan | Feb | Mar | Apr | May | Jun | Jul | Aug | Sep | Oct | Nov | Dec |
|------------|-----|-----|-----|-----|-----|-----|-----|-----|-----|-----|-----|-----|
| | 1 | 2 | 3 | 4 | 5 | 6 | 7 | 8 | 9 | O | N | D |

Maximum Ratings @T_A = 25°C unless otherwise specified

| Characteristic | Symbol | Value | Unit |
|-----------------------------------|---------------------|--|------|
| Supply Voltage, <Pin: (3) to (2)> | V _{CC} | 50 | V |
| Input Voltage, <Pin: (1) to (2)> | V _{IN} | DDTC113ZCA -5 to +10 DDTC123YCA -5 to +12 DDTC123JCA -5 to +12 DDTC143XCA -7 to +20 DDTC143FCA -6 to +30 DDTC143ZCA -5 to +30 DDTC114YCA -6 to +40 DDTC114WCA -10 to +30 DDTC124XCA -10 to +40 DDTC144VCA -15 to +40 DDTC144WCA -10 to +40 | V |
| Output Current | I _O | DDTC113ZCA 100 DDTC123YCA 100 DDTC123JCA 100 DDTC143XCA 100 DDTC143FCA 100 DDTC143ZCA 100 DDTC114YCA 70 DDTC114WCA 100 DDTC124XCA 50 DDTC144VCA 30 DDTC144WCA 30 | mA |
| Output Current | I _{C(MAX)} | 100 | mA |

Thermal Characteristics

| Characteristic | Symbol | Value | Unit |
|--|-----------------------------------|-------------|------|
| Power Dissipation (Notes 5 & 6) | P _D | 200 | mW |
| Thermal Resistance, Junction to Ambient Air (Note 5) | R _{θJA} | 625 | °C/W |
| Operating and Storage Temperature Range | T _J , T _{STG} | -55 to +150 | °C |

Notes: 5. Mounted on FR4 PC Board with minimum recommended pad layout
 6. 150mW per element must not be exceeded.

Electrical Characteristics @T_A = 25°C unless otherwise specified

| Characteristic | | Symbol | Min | Typ | Max | Unit | Test Condition | |
|----------------------------|---|---------------------------------|---|-----|--|---|--|--|
| Input Voltage | DDTC113ZCA DDTC123YCA DDTC123JCA DDTC143XCA DDTC143FCA DDTC143ZCA DDTC114YCA DDTC114WCA DDTC124XCA DDTC144VCA DDTC144WCA | V _{I(OFF)} | 0.3 0.3 0.5 0.3 0.3 0.5 0.3 0.8 0.4 1.0 0.8 | — | — | — | V | V _{CC} = 5V, I _O = 100μA |
| | DDTC113ZCA DDTC123YCA DDTC123JCA DDTC143XCA DDTC143FCA DDTC143ZCA DDTC114YCA DDTC114WCA DDTC124XCA DDTC144VCA DDTC144WCA | | V _{I(ON)} | — | — | 3.0 3.0 1.1 2.5 1.3 1.3 1.4 3.0 2.5 5.0 4.0 | | V _O = 0.3V, I _O = 20mA V _O = 0.3V, I _O = 20mA V _O = 0.3V, I _O = 5mA V _O = 0.3V, I _O = 20mA V _O = 0.3V, I _O = 3mA V _O = 0.3V, I _O = 5mA V _O = 0.3V, I _O = 1mA V _O = 0.3V, I _O = 2mA V _O = 0.3V, I _O = 2mA V _O = 0.3V, I _O = 2mA V _O = 0.3V, I _O = 2mA |
| Output Voltage | | V _{O(ON)} | — | 0.1 | 0.3 | V | I _O /I _I = 5mA/0.25mA DDTC123JCA I _O /I _I = 5mA/0.25mA DDTC143ZCA I _O /I _I = 5mA/0.25mA DDTC114YCA I _O /I _I = 10mA/0.5mA All Others | |
| Input Current | DDTC113ZCA DDTC123YCA DDTC123JCA DDTC143XCA DDTC143FCA DDTC143ZCA DDTC114YCA DDTC114WCA DDTC124XCA DDTC144VCA DDTC144WCA | I _I | — | — | 7.2 3.8 3.6 1.8 1.8 1.8 0.88 0.88 0.36 0.16 0.16 | mA | V _I = 5V | |
| Output Current | | I _{O(OFF)} | — | — | 0.5 | μA | V _{CC} = 50V, V _I = 0V | |
| DC Current Gain | DDTC113ZCA DDTC123YCA DDTC123JCA DDTC143XCA DDTC143FCA DDTC143ZCA DDTC114YCA DDTC114YCAQ DDTC114WCA DDTC124XCA DDTC144VCA DDTC144WCA | G _I | 33 33 80 30 68 80 68 80 24 68 33 56 | — | — | — | V _O = 5V, I _O = 5mA V _O = 5V, I _O = 10mA V _O = 5V, I _O = 10mA V _O = 5V, I _O = 10mA V _O = 5V, I _O = 10mA V _O = 5V, I _O = 10mA V _O = 5V, I _O = 5mA V _O = 5V, I _O = 5mA V _O = 5V, I _O = 10mA V _O = 5V, I _O = 5mA V _O = 5V, I _O = 5mA V _O = 5V, I _O = 5mA | |
| Input Resistor Tolerance | | ΔR ₁ | -30 | — | +30 | % | — | |
| Resistance Ratio Tolerance | | ΔR ₂ /R ₁ | -20 | — | +20 | % | — | |
| Gain-Bandwidth Product* | | f _T | — | 250 | — | MHz | V _{CE} = 10V, I _E = 5mA, f = 100MHz | |

* Transistor - For Reference Only

Typical Curves – DDTC123JCA

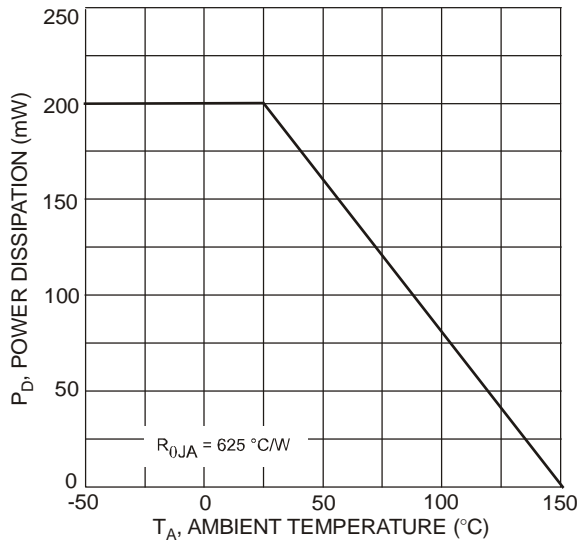

Fig. 1 Power Dissipation vs. Ambient Temperature

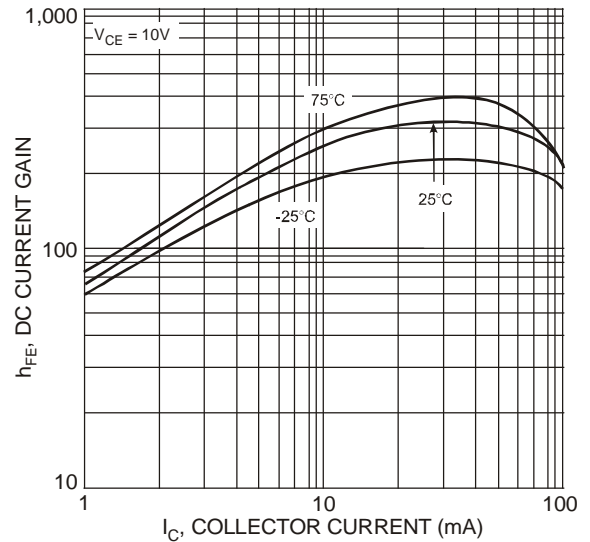

Fig. 2 Typical DC Current Gain vs. Collector Current

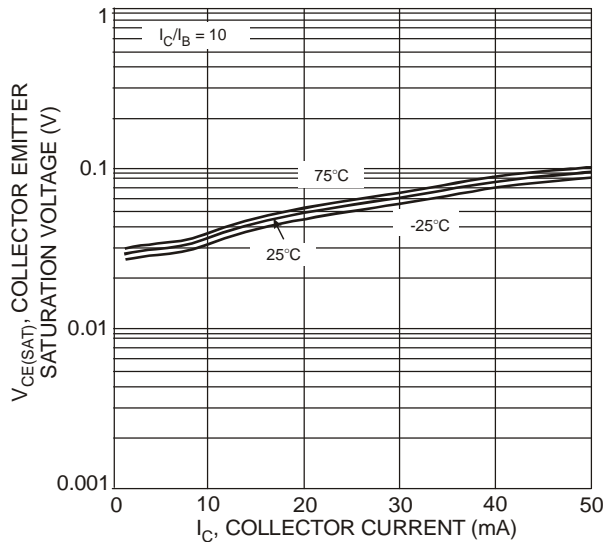

Fig. 3 Typical Collector Emitter Saturation Voltage vs. Collector Current

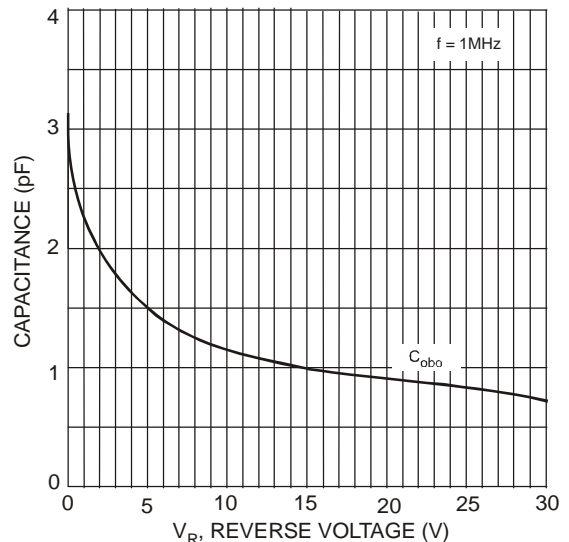

Fig. 4 Typical Capacitance Characteristics

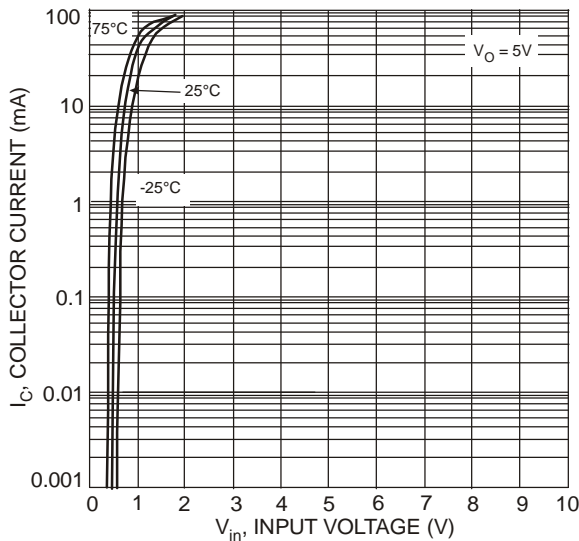

Fig. 5 Collector Current vs. Input Voltage

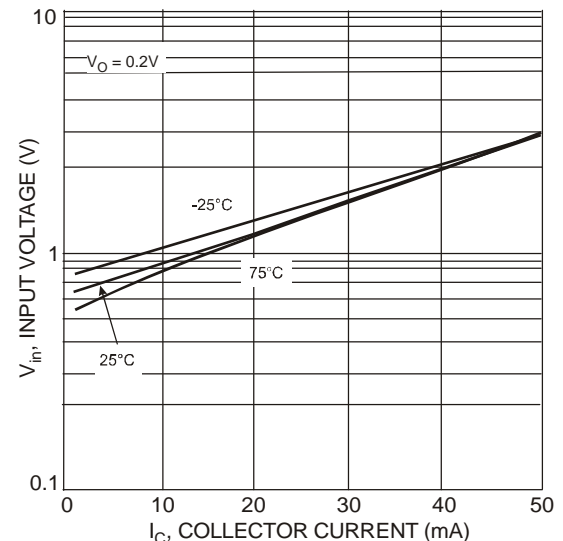
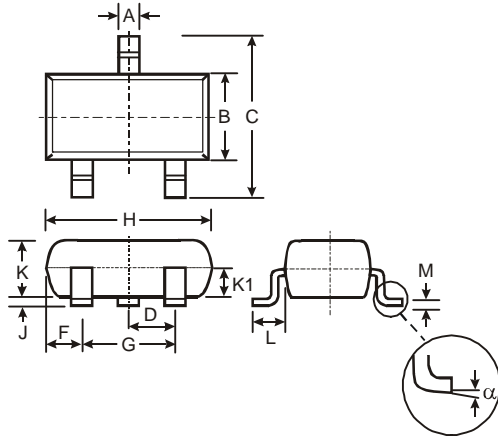

Fig. 6 Input Voltage vs. Collector Current

Package Outline Dimensions



| SOT23 | | | |
|----------------------|-------|------|-------|
| Dim | Min | Max | Typ |
| A | 0.37 | 0.51 | 0.40 |
| B | 1.20 | 1.40 | 1.30 |
| C | 2.30 | 2.50 | 2.40 |
| D | 0.89 | 1.03 | 0.915 |
| F | 0.45 | 0.60 | 0.535 |
| G | 1.78 | 2.05 | 1.83 |
| H | 2.80 | 3.00 | 2.90 |
| J | 0.013 | 0.10 | 0.05 |
| K | 0.903 | 1.10 | 1.00 |
| K1 | - | - | 0.400 |
| L | 0.45 | 0.61 | 0.55 |
| M | 0.085 | 0.18 | 0.11 |
| α | 0° | 8° | - |
| All Dimensions in mm | | | |

Suggested Pad Layout

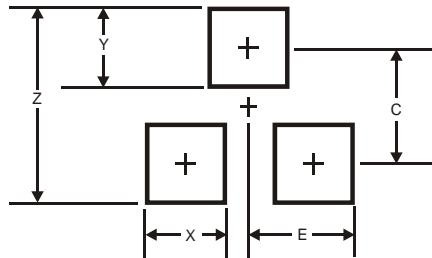

| Dimensions | Value (in mm) |
|------------|---------------|
| Z | 2.9 |
| X | 0.8 |
| Y | 0.9 |
| C | 2.0 |
| E | 1.35 |

IMPORTANT NOTICE

DIODES INCORPORATED MAKES NO WARRANTY OF ANY KIND, EXPRESS OR IMPLIED, WITH REGARDS TO THIS DOCUMENT, INCLUDING, BUT NOT LIMITED TO, THE IMPLIED WARRANTIES OF MERCHANTABILITY AND FITNESS FOR A PARTICULAR PURPOSE (AND THEIR EQUIVALENTS UNDER THE LAWS OF ANY JURISDICTION).

Diodes Incorporated and its subsidiaries reserve the right to make modifications, enhancements, improvements, corrections or other changes without further notice to this document and any product described herein. Diodes Incorporated does not assume any liability arising out of the application or use of this document or any product described herein; neither does Diodes Incorporated convey any license under its patent or trademark rights, nor the rights of others. Any Customer or user of this document or products described herein in such applications shall assume all risks of such use and will agree to hold Diodes Incorporated and all the companies whose products are represented on Diodes Incorporated website, harmless against all damages.

Diodes Incorporated does not warrant or accept any liability whatsoever in respect of any products purchased through unauthorized sales channel. Should Customers purchase or use Diodes Incorporated products for any unintended or unauthorized application, Customers shall indemnify and hold Diodes Incorporated and its representatives harmless against all claims, damages, expenses, and attorney fees arising out of, directly or indirectly, any claim of personal injury or death associated with such unintended or unauthorized application.

Products described herein may be covered by one or more United States, international or foreign patents pending. Product names and markings noted herein may also be covered by one or more United States, international or foreign trademarks.

LIFE SUPPORT

Diodes Incorporated products are specifically not authorized for use as critical components in life support devices or systems without the express written approval of the Chief Executive Officer of Diodes Incorporated. As used herein:

A. Life support devices or systems are devices or systems which:

1. are intended to implant into the body, or
2. support or sustain life and whose failure to perform when properly used in accordance with instructions for use provided in the labeling can be reasonably expected to result in significant injury to the user.

B. A critical component is any component in a life support device or system whose failure to perform can be reasonably expected to cause the failure of the life support device or to affect its safety or effectiveness.

Customers represent that they have all necessary expertise in the safety and regulatory ramifications of their life support devices or systems, and acknowledge and agree that they are solely responsible for all legal, regulatory and safety-related requirements concerning their products and any use of Diodes Incorporated products in such safety-critical, life support devices or systems, notwithstanding any devices- or systems-related information or support that may be provided by Diodes Incorporated. Further, Customers must fully indemnify Diodes Incorporated and its representatives against any damages arising out of the use of Diodes Incorporated products in such safety-critical, life support devices or systems.

Copyright © 2011, Diodes Incorporated

www.diodes.com



Компания «ЭлектроПласт» предлагает заключение долгосрочных отношений при поставках импортных электронных компонентов на взаимовыгодных условиях!

Наши преимущества:

- Оперативные поставки широкого спектра электронных компонентов отечественного и импортного производства напрямую от производителей и с крупнейших мировых складов;
- Поставка более 17-ти миллионов наименований электронных компонентов;
- Поставка сложных, дефицитных, либо снятых с производства позиций;
- Оперативные сроки поставки под заказ (от 5 рабочих дней);
- Экспресс доставка в любую точку России;
- Техническая поддержка проекта, помощь в подборе аналогов, поставка прототипов;
- Система менеджмента качества сертифицирована по Международному стандарту ISO 9001;
- Лицензия ФСБ на осуществление работ с использованием сведений, составляющих государственную тайну;
- Поставка специализированных компонентов (Xilinx, Altera, Analog Devices, Intersil, Interpoint, Microsemi, Aeroflex, Peregrine, Syfer, Eurofarad, Texas Instrument, Miteq, Cobham, E2V, MA-COM, Hittite, Mini-Circuits, General Dynamics и др.);

Помимо этого, одним из направлений компании «ЭлектроПласт» является направление «Источники питания». Мы предлагаем Вам помощь Конструкторского отдела:

- Подбор оптимального решения, техническое обоснование при выборе компонента;
- Подбор аналогов;
- Консультации по применению компонента;
- Поставка образцов и прототипов;
- Техническая поддержка проекта;
- Защита от снятия компонента с производства.



Как с нами связаться

Телефон: 8 (812) 309 58 32 (многоканальный)

Факс: 8 (812) 320-02-42

Электронная почта: org@eplast1.ru

Адрес: 198099, г. Санкт-Петербург, ул. Калинина, дом 2, корпус 4, литера А.