

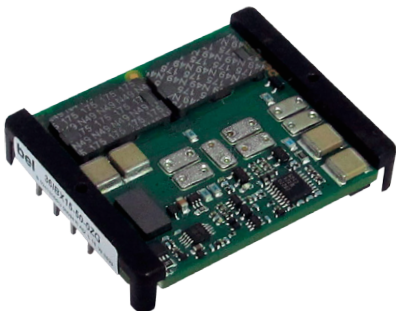

**MELCHER**  
The Power Partners.

a bel power solutions brand

## IBX15 Series Boost Converters

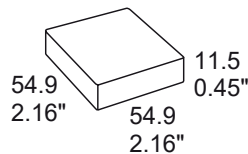

The boost converters were designed in accordance with the standards EN 50155 and EN 50121-3-2 to meet the requirements of various railway and industrial applications in rugged environment. They are particularly suitable to expand the input voltage range of power supplies (e.g. 110IMY15 or 110IMY70 Series DC-DC converters). An additional circuit allows for providing a predefined interruption time.

When the input voltage exceeds a predefined output voltage level, the input voltage is directly fed forward. The converters exhibit an input EMC-filter.

The boost converters are available in a fully enclosed case or open-frame (option Z).

### Features

- RoHS-compliant for all 6 substances
- 5 year warranty
- Wide input voltage range 16.8 to 154 VDC
- Output: 50 to 80 VDC
- Class III equipment (no isolation input/output)
- Extremely high efficiency
- Excellent surge and transient protection
- Externally adjustable output voltage
- Programmable undervoltage lockout and inhibit
- Interruption time with external capacitor
- EN 50155, 50121-3-2 observed

Safety-approved to the latest edition of IEC/EN 60950-1 and UL/CSA 60950-1



### Table of Contents

	Page	Page	
Description.....	1	Electromagnetic Compatibility (EMC).....	7
Model Selection.....	2	Immunity to Environmental Conditions.....	9
Functional Description.....	2	Mechanical Data.....	10
Electrical Input Data.....	3	Safety and Installation Instructions.....	10
Electrical Output Data.....	5	Options.....	11
Auxiliary Functions.....	6		

### Model Selection

Table 1: Model Selection

Input voltage $V_{i\ nom}$	Operating input range $V_i$	Output Voltage $V_{o\ nom}$	Output Current $I_{o\ nom}$	Efficiency <sup>1</sup>		Type designation	Options
				$\eta_{min}$	$\eta_{typ}$		
24 V	16.8 - 154 VDC	50 - 154 VDC	1.6 A	89 %	93 %	24IBX15-50-0G	Z
36 V	25.2 - 154 VDC	50 - 154 VDC	2.2 A	91 %	95 %	36IBX15-50-0G	

<sup>1</sup> Efficiency at  $V_i = V_{i\ min}$ ,  $V_o = V_{o\ nom}$ ,  $I_o = I_{o\ nom}$

### Functional Description

The IBX15 boost converter is designed as step-up converter in order to increase the input voltage  $V_i$  to the regulated boost voltage  $V_{oB\ tr}$ . When  $V_i$  exceeds  $V_{oB\ tr}$ , the output voltage follows  $V_i$ . The resulting voltage (see fig. 1) is within the range of  $V_{oB\ tr}$  to  $V_{i\ max}$ , which is suitable for adequate DC-DC converters, e.g. 110IMY15 or 110IMY70 for 24/36IBX15-50. The IBX15 converters have no input-to-output isolation; isolation is provided by the DC-DC converters connected to the output.

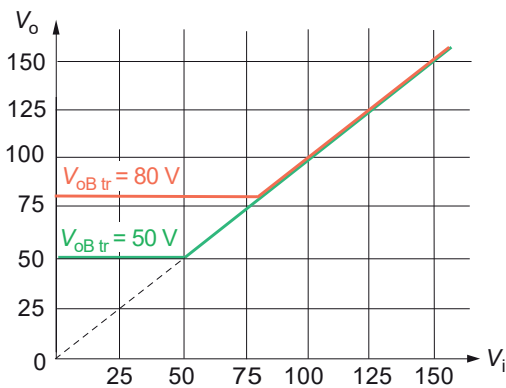

Fig. 1  
 $V_o$  versus  $V_i$  depending on  $V_{oB\ tr}$

The inrush current is not limited, but the output capacitor of the IBX15 and the input capacitors of the connected DC-DC converters are relatively small.

The switching frequency is approximately  $2 \times 200$  kHz (interleaved). A current limiting circuit protects the main FETs from overload. However, the output is not short-circuit proof.

The logic is biased by an auxiliary converter with a switching frequency of approx. 350 kHz. The boost voltage  $V_{oB}$  can be trimmed by resistor  $R_{BA}$  to a higher level  $V_{oB\ tr}$ . This allows together with an external storage capacitor  $C_{hu}$  the realization of an interruption time as requested by the railway standard EN 50155. No other components are needed.

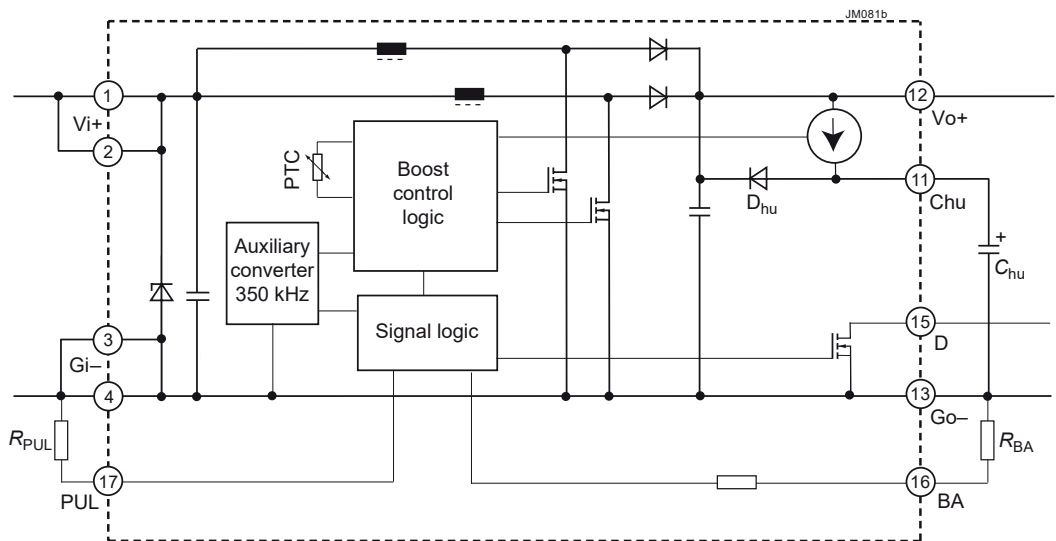

Fig. 2  
Functional diagram

### Electrical Input Data

General conditions:

-  $T_A = 25\text{ }^\circ\text{C}$ , unless  $T_C$  is specified.

Table 2: Input data

Model			24IBX15-50-0G			36IBX15-50-0G			Unit
Characteristics		Conditions	min	typ	max	min	typ	max	
$V_i$	Operating input voltage		16.8		154	25.2		154	V
$V_{i2s}$	Temporary input voltage	2 s	12		168	21.3		168	
$V_{iabs}$	Input voltage limits	2 s, without damage			176			176	
$\Delta V_{i/o}$	Voltage drop $V_i - V_o$	$V_i > V_{oB}$			1			1	
$I_i$	Typical input current	$V_{i\min}, I_{o\text{nom}}$			8			6	A
$C_i$	Input capacitance	for surge calculation					4		$\mu\text{F}$
$t_{\text{start}}$	Start-up time of $V_o$	$V_i \rightarrow V_{i\min}$ or after shutdown			500			500	ms
$P_{i0}$	No-load input power	$V_{i\min} - V_{i\max}, I_o = 0$		1.0	1.5		1.0	1.5	W
$P_{iSD}$	Input power with shutdown	$V_{i\min} - V_{i\max}, V_{PUL} = 0$							

### Input Protection and Fuse

No fuse is incorporated inside the converter. Consequently, an external fuse or a circuit breaker at system level should be installed to protect against severe defects; see table 3.

Reverse polarity protection is provided by an antiparallel diode across the input, causing the external input fuse or circuit breaker to trip.

**Note:** The fuses in table 4 apply to batteries with  $V_{i\text{nom}} = 24$  or  $36$  V. In applications using batteries with higher voltage, fuses with lower current may suit better.

Table 3: Recommended external fuses in the non-earthed input line

Converter model	Fuse type
24IBX15-50-0G	Littlefuse 218, 10 A / 250 VAC, fast
36IBX15-50-0G	Littlefuse 218, 8 A / 250 VAC, fast, or: Schurter SPT 8 A, 300 VDC

### Programmable Undervoltage Lockout PUL

The programmable input undervoltage lockout (PUL, pin 17) should be adjusted adequately in order to limit the input current. Table 4 shows the values of the resistor  $R_{PUL}$ , connected between PUL and  $V_{i-}$ , versus the resultant minimum input voltage and the resultant maximum input current.

**Note:** If PUL is connected to  $V_{i-}$ , the converter is disabled (shutdown).

Table 4: Typical values for  $R_{PUL}$  and the resultant turn-on input voltage  $V_{iLO}$ . Valid for version V105 (Rev. AE) or later.

24IBX15-50-0G		36IBX15-50-0G	
$R_{PUL}$ [k $\Omega$ ]	$V_{iLO}$ [V]	$R_{PUL}$ [k $\Omega$ ]	$V_{iLO}$ [V]
$\infty$	15	$\infty$	23
110	18	100	27
68	20	56	30
43	23	36	34
27	27	27	38

### Efficiency

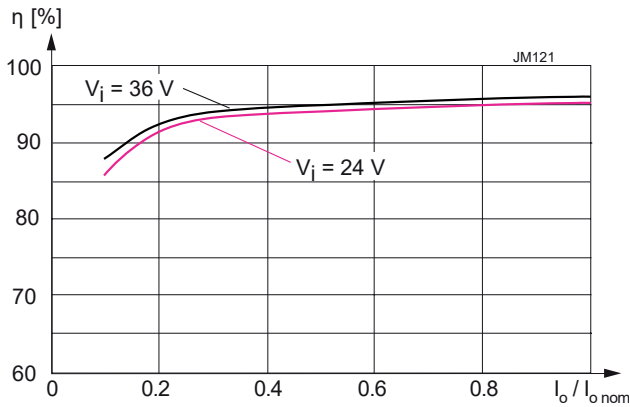

Fig. 3 Efficiency versus input voltage and output current (24IBX15-50-0G)

### Interruption Time

The interruption time of a system comprised of a step-up converter IBX15 (Rev. AB or later) and connected converters can easily be increased by an external capacitor  $C_{hu}$  and adjusting the boost voltage  $V_{oB tr}$  to a higher level.

As an example, fig. 4 shows a 36IBX15-50 supplying a DC-DC converter 110IMY70-12.

Formula for the external boost capacitor  $C_{hu}$ :

$$C_{hu} = \frac{2 \cdot P_o \cdot t_{hu}}{(V_{oB tr}^2 - V_{i min}^2)}$$

whereas:

- $C_{hu}$  = external boost capacitance [mF]
- $P_o$  = output power = input power of the supplied converter [W]
- $t_{hu}$  = interruption or hold-up time [ms]
- $V_{i min}$  = min. input voltage of supplied converters [V]
- $V_{oB tr}$  = boost voltage trimmed using  $R_{BA}$  [V]

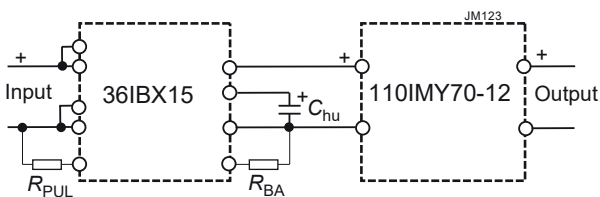

Fig. 4 System with increased interruption time

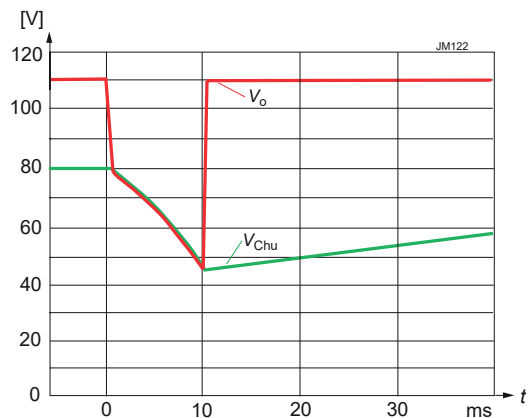

Fig. 5 Increased interruption time.  $V_i = 110 V$ ,  $C_{hu} = 560 \mu F / 100 V$ ,  $P_o = 90 W$ ,  $V_{oB tr} = 80 V$ ,  $R_{BA} = 0 \Omega$ . (24IBX15-50-0G)

The external boost capacitor is loaded by a current source to the preselected boost voltage  $V_{oB tr}$ . This current source is activated after  $V_o$  has reached or exceeded  $V_{oB tr}$ . If the input voltage is increasing further, the boost capacitor is not charged beyond  $V_{oB tr}$ . Consequently, its rated voltage needs not to be much higher than  $V_{oB tr}$ .

In the case of input voltage loss, the output voltage  $V_o$  drops rapidly to  $V_{oB tr}$  until the diode  $D_{hu}$  connects the output with the boost capacitor, sustaining the output voltage; see fig. 5. As long as  $V_{i min}$  of the supplied converter is not undercut (during  $t_{hu}$ ), the output voltage of the supplied converter is not affected.

### Electrical Output Data

General conditions:

$$- T_A = 25 \text{ }^\circ\text{C, unless } T_C \text{ is specified. } V_i < V_{oB \text{ min}}, I_o < I_{o \text{ nom}}$$

Table 5: Output data

Output		Conditions	24IBX15-50-0G			36IBX15-50-0G			Unit
Characteristics	min		typ	max	min	typ	max		
$V_{oB r}$	Boost voltage regulated	$V_{i \text{ min}}, I_{o \text{ nom}}, R_{BA} = \infty$	49	50	51	49	50	51	V
$V_{oB tr}$	Boost voltage trim range	depending on $R_{BA}$	49		80	49		80	
$I_{o \text{ nom}}$	Nominal output current	$V_{i \text{ min}} - V_{i \text{ max}}, V_{oB r}$		1.6			2.2		A
$V_{ow}$	Static line / load regulation	$V_{i \text{ min}} - V_{oB r}, 0 - I_{o \text{ nom}}$		$\pm 1$	$\pm 2$		$\pm 1$	$\pm 2$	V
$V_{od}$	Dynamic line / load regulation			$\pm 2$			$\pm 2$		
$t_d$	Dynamic recovery time				2			2	ms
$I_{BC}$	Current to boost capacitor	$V_o \geq V_{oB r}$	3.9	4.3	4.8	3.9	4.3	4.8	mA
$t_{hu}$	Interruption time <sup>1</sup>	$C_{hu} = 1000 \mu\text{F}$ $V_{oB tr} = 50 \text{ V}, V_i = V_{i \text{ min}}$		-			-		ms
$t_{loadC}$	Load time for $C_{hu}$ <sup>1</sup>			-			-		s
$t_{hu}$	Interruption time <sup>1</sup>	$C_{hu} = 560 \mu\text{F}$ $V_{oB tr} = 80 \text{ V}, V_i = V_{i \text{ min}}$	10	11		10	11		ms
$t_{loadC}$	Load time for $C_{hu}$ <sup>1</sup>		12	15	18	12	15	18	s

<sup>1</sup> For other values use the formula in section *Interruption Time* !

### Parallel or Series Operation

Not possible.

### Thermal Considerations

If a converter, mounted on a PCB, is located in free, quasi-stationary air (convection cooling) at the indicated maximum ambient temperature  $T_{A \text{ max}}$  (see table *Temperature specifications*) and is operated at its nominal operating conditions, the case temperature measured at the measuring point of case temperature  $T_C$  (see *Mechanical Data*) will approach the indicated value  $T_{C \text{ max}}$  after the warm-up phase. However, the relationship between  $T_A$  and  $T_C$  depends heavily on the conditions of operation and integration into a system. The thermal conditions are influenced by input voltage, output current, airflow, temperature of surrounding components and surfaces, and the properties of the printed circuit board.  $T_{A \text{ max}}$  is therefore only an indicative value.

**Caution:** The case temperature  $T_C$  measured at the measuring point of case temperature  $T_C$  (see *Mechanical Data*) shall under no circumstances exceed the specified maximum value. The installer must ensure that under all operating conditions  $T_C$  remains within the limits stated in the table *Temperature specifications*.

### Overtemperature Protection

The converters are protected from possible overheating by an internal temperature monitoring circuit. It shuts down the converter above the internal temperature limit, and automatically restarts, after the temperature dropped.

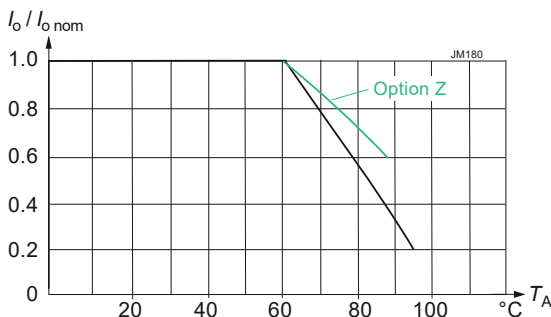

Fig. 6a  
24IBX15:  $I_o$  versus temperature  
 $I_{o \text{ nom}} = 1.6 \text{ A}, V_i = 16.8 \text{ V}, V_{oB tr} = 50 \text{ V}$

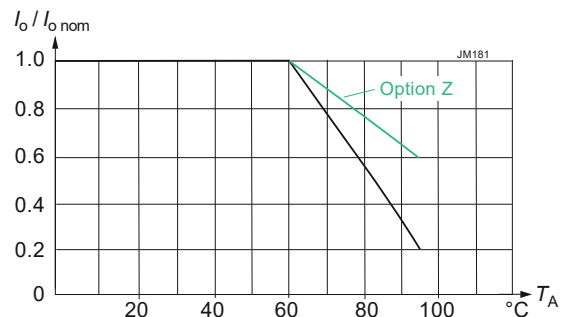

Fig. 6b  
36IBX15:  $I_o$  versus temperature  
 $I_{o \text{ nom}} = 2.2 \text{ A}, V_i = 25.2 \text{ V}, V_{oB tr} = 50 \text{ V}$

## Auxiliary Functions

### Boost Voltage Adjust

The regulated boost voltage  $V_{oB\ tr}$  can be adjusted by an external adjust resistor  $R_{BA}$ ; see fig. 1. The values of  $R_{BA}$  are specified in table 6.

Table 6: Typical values for  $R_{BA}$  and the resultant boost voltage  $V_{oB\ tr}$  and the possible output current  $I_o$ .

$R_{BA}$ [k $\Omega$ ]	24IBX15-50-0G		36IBX15-50-0G	
	$V_{oB\ tr}$ [V]	$I_o$ [A]	$V_{oB\ tr}$ [V]	$I_o$ [A]
$\infty$	50	1.60	50	2.20
121	55	1.42	55	1.95
46.5	60	1.27	60	1.75
23	65	1.05	65	1.45
11.2	70	0.92	70	1.26
4.3	75	0.84	75	1.16
0	80	0.79	80	1.08

Of course, the real output voltage  $V_o$  follows  $V_i$  when  $V_i$  is higher than  $V_{Br}$ . However, the voltage on pin 11 will never exceed the adjusted value of  $V_{oB\ tr}$ . The external capacitor  $C_{hu}$  must only be rated to  $V_{oB\ tr}$ .

The max. output current will decrease with higher  $V_{oB\ tr}$ , but the output power remains constant, because the supplied 110IMY converters need lower input current with higher input voltage.

### Out-OK Signal

An open-collector signal controls the function of the boost converter. When  $V_{oBr}$  is exceeded, the D-output is connected with a FET to Go– (pin 15); see table 7.

Table 7: Out-OK data

Characteristics		Conditions	min	typ	max	Unit
$V_{OK}$	Out-OK voltage	Output okay, $I_{OK} < 50$ mA		0.3	0.5	V
$I_{OK}$	Out-OK current	Output fail, $V_{OK} \leq 80$ V		15	60	$\mu$ A

### Electromagnetic Compatibility (EMC)

A suppressor diode together with the input choke form an effective protection against high input transient voltages which typically occur in many installations, but especially in battery-driven mobile applications. The auxiliary converter has a separate input filter.

### Electromagnetic Immunity

Table 6: Electromagnetic immunity (type tests)

Phenomenon	Standard	Level	Coupling mode <sup>1</sup>	Value applied	Waveform	Source imped.	Test procedure	In oper.	Perf. crit. <sup>2</sup>
Electrostatic discharge (to case)	IEC/EN 61000-4-2 <sup>3</sup>	-	contact discharge	$\pm 6000 V_p$	1/50 ns	330 $\Omega$ 150 pF	10 pos. & 10 neg. discharges	yes	B
		3	air discharge	$\pm 8000 V_p$					
Electromagnetic field	IEC/EN 61000-4-3	x <sup>4</sup>	antenna	20 V/m	AM 80% / 1 kHz	N/A	80 – 1000 MHz	yes	A
		5	antenna	20 V/m	AM 80% / 1 kHz	N/A	800 – 1000 MHz	yes	A
				10 V/m			1400 – 2100 MHz		
5 V/m	2100 – 2500 MHz								
Electrical fast transients / burst	IEC/EN 61000-4-4	3 <sup>6</sup>	direct coupling +i/c, -i/c, +i/-i	$\pm 2000 V_p$	bursts of 5/50 ns; 5 kHz over 15 ms; burst period: 300 ms	50 $\Omega$	60 s positive 60 s negative transients per coupling mode	yes	A
		4		$\pm 4000 V_p$				yes	B
		3	capacitive, o/c	$\pm 2000 V_p$				yes	B
Surges	IEC/EN 61000-4-5	3 <sup>7</sup>	+i/c, -i/c	$\pm 2000 V_p$	1.2 / 50 $\mu$ s	42 $\Omega$ 0.5 $\mu$ F	5 pos. & 5 neg. surges per coupling mode	yes	A
		2 <sup>7</sup>	+i/-i	$\pm 1000 V_p$				yes	B
Conducted disturbances	IEC/EN 61000-4-6	3 <sup>8</sup>	i, o, signal wires	10 VAC (140 dB $\mu$ V)	AM 80% / 1 kHz	150 $\Omega$	0.15 – 80 MHz	yes	A

<sup>1</sup> i = input, o = output, c = case (not for option Z)

<sup>2</sup> A = normal operation, no deviation from specification, B = temporary deviation from specs. possible.

<sup>3</sup> Corresponds to EN 50121-3-2:2016 table 5.1 and exceeds EN 50121-4:2016 table 2.1.

<sup>4</sup> Corresponds to EN 50121-3-2:2016 table 5.1 and exceeds EN 50121-4:2016 table 2.1.

<sup>5</sup> Corresponds to EN 50121-3-2:2016 table 5.2 and EN 50121-4:2016 table 2.2.

<sup>6</sup> Corresponds to EN 50121-3-2:2016 table 3.2 and EN 50121-4:2016 table 4.2.

<sup>7</sup> Measured with an external input capacitor 600  $\mu$ F (to compensate for the network impedance for surge tests).

Corresponds to EN 50121-3-2:2016, table 3.3, and EN 50121-4:2016 table 4.3.

<sup>8</sup> Corresponds to EN 50121-3-2:2016 table 3.1 and EN 50121-4:2016 table 4.1.

### Electromagnetic Emissions

The EMC requirements must be observed at the end product system level. However, the company tests the converters to EMC standards. The integrated input filter reduces the reflected input current and improves EMC features. Further improvements are possible by adding simple external filters; see fig. below.

The large input capacitor C1 (100  $\mu$ F /200 V) provides stability during surge tests. The other components are:

C2 = 4.7 nF, Y2; C51 = C52 = 10 nF, Y2

C3 = 3  $\mu$ F, X7R; C4 = 5  $\mu$ F, X7R

L1 = 4.4 mH

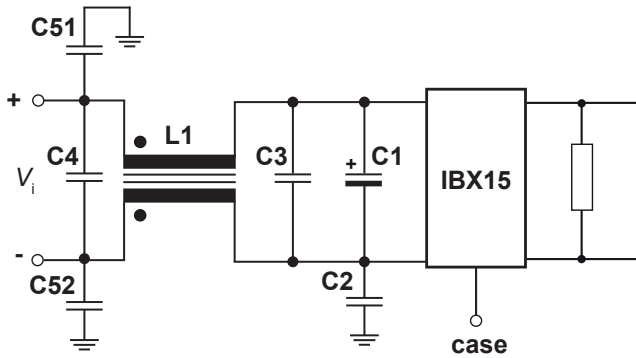

Fig. 7  
Input filter for disturbance tests

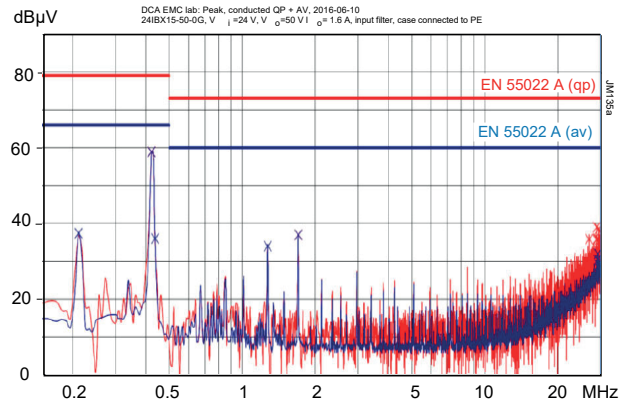

Fig. 8  
Conducted emissions of 24IBX15-50-0G.  $V_i = 24$  V,  $V_o = 50$  V, 2 A; case connected to PE; with input filter fig. 7



### Immunity to Environmental Conditions

Table 7: Mechanical and climatic stress

Test method		Standard	Test Conditions		Status
Cab	Damp heat steady state	IEC/EN 60068-2-78 MIL-STD-810D section 507.2	Temperature:	40 ±2 °C	Converter not operating
			Relative humidity:	93 ±2/-3 %	
			Duration:	56 days	
Ad	Cooling test steady state	EN 50155:2007, clause 12.2.3 IEC/EN 60068-2-1	Temperature, duration:	-40 °C, 2 h	Converter not operating
			Performance test:	+25 °C	
Bd	Dry heat test steady state	EN 50155:2007, clause 12.2.4 IEC/EN 60068-2-2	Temperature:	70 °C	Converter operating
			Duration:	6 h	
Ka	Salt mist test sodium chloride (NaCl) solution	EN 50155:2007, clause 12.2.10 IEC/EN 60068-2-11 class ST2	Temperature:	35 ±2 °C	Converter not operating
			Duration:	16 h	
Fc	Vibration (sinusoidal)	IEC/EN 60068-2-6 MIL-STD-810D section 514.3	Acceleration amplitude:	0.35 mm (10 – 60 Hz) 5 g <sub>n</sub> = 49 m/s <sup>2</sup> (60 - 2000 Hz)	Converter operating
			Frequency (1 Oct/min):	10 – 2000 Hz	
			Test duration:	7.5 h (2.5 h in each axis)	
Fh	Random vibration broad band (digital control) & guidance	IEC/EN 60068-2-64	Acceleration spectral density:	0.05 g <sub>n</sub> <sup>2</sup> /Hz	Converter operating
			Frequency band:	8 – 500 Hz	
			Acceleration magnitude:	4.9 g <sub>n,rms</sub>	
			Test duration:	1.5 h (5 h in each axis)	
Ea	Shock (half-sinusoidal)	IEC/EN 60068-2-27 MIL-STD-810D section 516.3	Acceleration amplitude:	50 g <sub>n</sub> = 490 m/s <sup>2</sup>	Converter operating
			Bump duration:	11 ms	
			Number of bumps:	18 (3 in each direction)	
	Shock	EN 50155:2007, clause 12.2.11 EN 61373 sect. 10 class B, body mounted <sup>1</sup>	Acceleration amplitude:	5.1 g <sub>n</sub>	Converter operating
			Bump duration:	30 ms	
			Number of bumps:	18 (3 in each direction)	
	Simulated long life testing at increased random vibration levels	EN 50155:2007, clause 12.2.11 EN 61373 sect. 8 and 9 class B, body mounted <sup>1</sup>	Acceleration spectral density:	0.02 g <sub>n</sub> <sup>2</sup> /Hz	Converter operating
			Frequency band:	5 – 150 Hz	
			Acceleration magnitude:	0.8 g <sub>n,rms</sub>	
			Test duration:	18 (3 in each direction)	

<sup>1</sup> Body mounted = chassis of a railway coach

### Temperatures

Table 8: Temperature specifications, valid for an air pressure of 800 – 1200 hPa (800 – 1200 mbar)

Model		-0G (with case)			-0ZG (open frame)			Unit		
Characteristics		Conditions		min	typ	max	min		typ	max
T <sub>A</sub>	Ambient temperature	Converter operating		- 40		70	- 40		70	° C
T <sub>C</sub> , T <sub>CZ</sub>	Case temperature <sup>1</sup>			- 40		100	- 40		120	
T <sub>S</sub>	Storage temperature	Not operational		- 55		85	- 55		85	

### Reliability

Table 11: MTBF and device hours

Ratings	Model	Ground benign	Ground fixed		Ground mobile	Unit
			40 °C	70 °C		
Case temperature		40 °C	40 °C	70 °C	50 °C	
MTBF accord. to Bellcore SR-332, issue 1	36IBX15-50	850 000	425 000	160 000	104 000	h

### Mechanical Data

Dimensions are in mm (inches).

Tolerances  $\pm 0.3$  mm (unless noted)

Recommended PCB hole diameter for the 1mm square pins: 1.4 mm

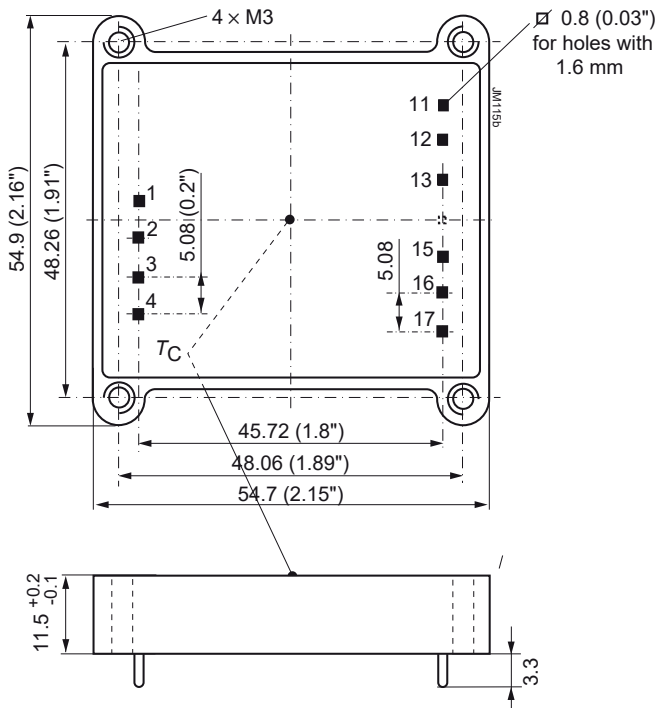

Fig. 9  
Case Zinc,  
weight approx. 80 g

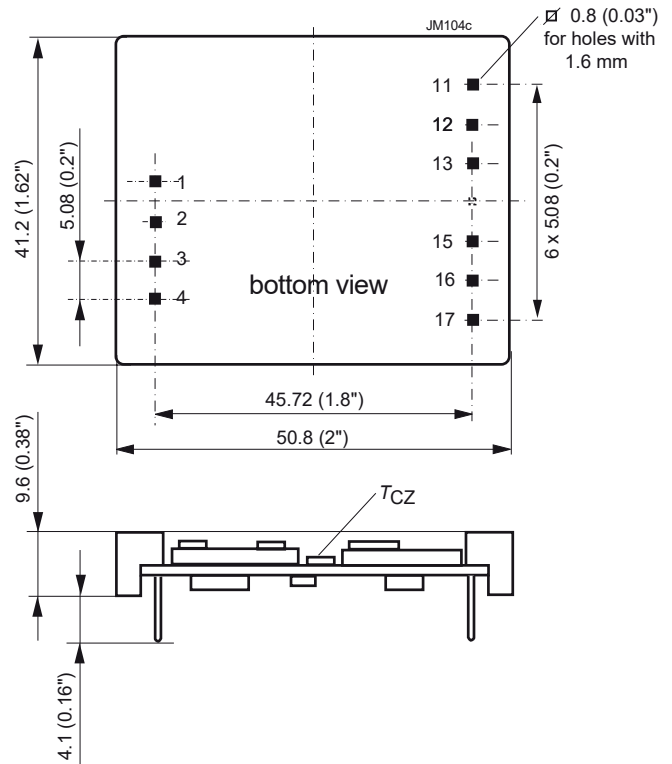

Fig. 10  
Open frame (option Z),  
weight approx. 30 g

### Safety and Installation Instruction

#### Pin Allocation

Table 12: Pin allocation (standard and option Z)

Pin	Name	Description
1	Vi+	Pos. input
2	Vi+	Pos. input
3	Gi-	Neg. input
4	Gi-	Neg. input
11	Chu	External hold-up capacitor
12	Vo+	Pos. output voltage
13	Go-	Neg. output (connected to pins 3 and 4)
14	-	No pin
15	D	Boost function okay
16	BA	Boost voltage adjust
17	PUL	Programmable undervoltage lockout / inhibit

### Installation Instructions

Connection to the system shall be made via a printed circuit board with hole diameters of 1.5 mm for the pins.

The converter must be connected to a secondary circuit.

Do not open the converter!

Ensure that a converter failure (e.g. by an internal short-circuit) does not result in hazardous conditions.

**Note:** To prevent excessive current flowing through the input supply lines in case of a malfunction an external fuse should be installed in a non-earthed input supply line; see table 3.

### Standards, Approvals, Isolation

The converters have been approved according to the latest edition of IEC/EN 60950-1 and UL/CSA 60950-1. The CE mark is fitted.

All pins are tested against the case with 1500 VAC (2120 VDC) for  $\geq 1$  s as routine test in the factory according to EN 50514 and IEC/EN 60950.

The converters are subject to manufacturing surveillance in accordance with the above mentioned standards and with ISO9001:2008.

CB scheme is available.

### Railway Applications

To comply with railway standards, all components are coated with a protective lacquer (except option Z).

### Protection Degree and Cleaning Liquids

The protection degree of the converters is IP 40, except open-frame models (option Z).

In order to avoid possible damage, any penetration of cleaning fluids should be prevented, since the converters are not hermetically sealed.

However, open-frame models (option Z) leave the factory unlacquered; they may be lacquered by the customer, for instance together with the mother board. Cleaning liquids are not permitted – except washing at room temperature with isopropyl alcohol and de-ionized/distilled water (1 : 1).

The mother board can also be cleaned, before fitting the open-frame converter.

**Note:** Other cleaning liquids may damage the adhesive joints of the ferrite cores.

### Options

Option Z: Open-frame model (no case).

**NUCLEAR AND MEDICAL APPLICATIONS** - These products are not designed or intended for use as critical components in life support systems, equipment used in hazardous environments, or nuclear control systems.

**TECHNICAL REVISIONS** - The appearance of products, including safety agency certifications pictured on labels, may change depending on the date manufactured. Specifications are subject to change without notice.



Компания «ЭлектроПласт» предлагает заключение долгосрочных отношений при поставках импортных электронных компонентов на взаимовыгодных условиях!

Наши преимущества:

- Оперативные поставки широкого спектра электронных компонентов отечественного и импортного производства напрямую от производителей и с крупнейших мировых складов;
- Поставка более 17-ти миллионов наименований электронных компонентов;
- Поставка сложных, дефицитных, либо снятых с производства позиций;
- Оперативные сроки поставки под заказ (от 5 рабочих дней);
- Экспресс доставка в любую точку России;
- Техническая поддержка проекта, помощь в подборе аналогов, поставка прототипов;
- Система менеджмента качества сертифицирована по Международному стандарту ISO 9001;
- Лицензия ФСБ на осуществление работ с использованием сведений, составляющих государственную тайну;
- Поставка специализированных компонентов (Xilinx, Altera, Analog Devices, Intersil, Interpoint, Microsemi, Aeroflex, Peregrine, Syfer, Eurofarad, Texas Instrument, Miteq, Cobham, E2V, MA-COM, Hittite, Mini-Circuits, General Dynamics и др.);

Помимо этого, одним из направлений компании «ЭлектроПласт» является направление «Источники питания». Мы предлагаем Вам помощь Конструкторского отдела:

- Подбор оптимального решения, техническое обоснование при выборе компонента;
- Подбор аналогов;
- Консультации по применению компонента;
- Поставка образцов и прототипов;
- Техническая поддержка проекта;
- Защита от снятия компонента с производства.



#### Как с нами связаться

**Телефон:** 8 (812) 309 58 32 (многоканальный)

**Факс:** 8 (812) 320-02-42

**Электронная почта:** [org@eplast1.ru](mailto:org@eplast1.ru)

**Адрес:** 198099, г. Санкт-Петербург, ул. Калинина, дом 2, корпус 4, литера А.