

5 V, SUPER MINIMOLD WIDEBAND SI RFIC AMPLIFIER

FEATURES

- **HIGH DENSITY SURFACE MOUNTING:**
6 pin super minimold or SOT-363 package
- **HIGH GAIN:** 15 dB TYP
- **SATURATED OUTPUT POWER:** +10 dBm
- **WIDEBAND RESPONSE:** $f_u = 2.9$ GHz TYP
- **SUPPLY VOLTAGE:** $V_{CC} = 4.5$ to 5.5 V

DESCRIPTION

The UPC2708TB is a Silicon RFIC manufactured using the NESAT III process. This device is suitable as buffer amplifier for DBS, PCS and other communication receivers. The UPC2708TB is pin compatible and has comparable performance as the larger UPC2708T, so it is suitable for use as a replacement to help reduce system size. The IC is housed in a 6 pin super minimold or SOT-363 package.

Stringent quality assurance and test procedures ensure the highest reliability and performance.

GAIN vs.
FREQUENCY and TEMPERATURE

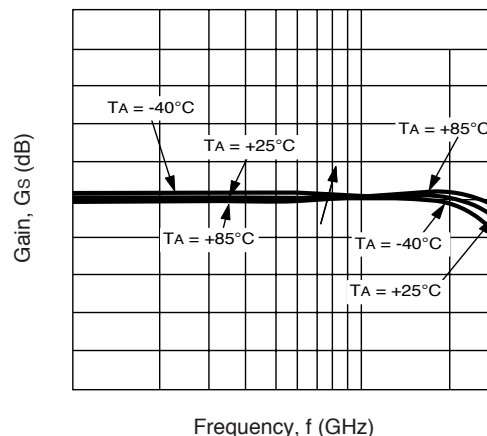

ELECTRICAL CHARACTERISTICS ($T_A = 25^\circ\text{C}$, $f = 1$ GHz, $V_{CC} = 5$ V)

| PART NUMBER PACKAGE OUTLINE | | | UPC2708TB S06 | | |
|--------------------------------|--|---------------------------|------------------|-----------|------|
| SYMBOLS | PARAMETERS AND CONDITIONS | UNITS | MIN | TYP | MAX |
| I_{CC} | Circuit Current (no signal) | mA | 20 | 26 | 33 |
| G_s | Small Signal Gain | dB | 13 | 15 | 18.5 |
| f_u | Upper Limit Operating Frequency (The gain at f_u is 3 dB down from the gain at 0.1 GHz) | GHz | 2.7 | 2.9 | |
| ΔG_s | Gain Flatness, $f = 0.1 - 2.6$ GHz | dB | | ± 0.8 | |
| P_{SAT} | Saturated Output Power | dBm | +7.5 | +10 | |
| P_{1dB} | Output Power at 1 dB Compression Point | dBm | | +7.5 | |
| NF | Noise Figure | dB | | 6.5 | 8 |
| R_{LIN} | Input Return Loss | dB | 8 | 11 | |
| R_{LOUT} | Output Return Loss | dB | 16 | 20 | |
| ISOL | Isolation | dB | 18 | 23 | |
| ΔG_T | Gain-Temperature Coefficient | dB/ $^\circ\text{C}$ | | +0.002 | |
| R_{TH} | Thermal Resistance (Junction to Ambient) | $^\circ\text{C}/\text{W}$ | | | 325 |

ABSOLUTE MAXIMUM RATINGS¹ (T_A = 25°C)

| SYMBOLS | PARAMETERS | UNITS | RATINGS |
|------------------|--------------------------------|-------|-------------|
| V _{CC} | Supply Voltage | V | 6 |
| P _{IN} | Input Power | dBm | +10 |
| P _T | Power Dissipation ² | mW | 200 |
| T _{OP} | Operating Temperature | °C | -40 to +85 |
| T _{STG} | Storage Temperature | °C | -55 to +150 |

Notes:

1. Operation in excess of any one of these parameters may result in permanent damage.
2. Mounted on 50 x 50 x 1.6 mm epoxy glass PWB (T_A = +85°C).

RECOMMENDED OPERATING CONDITIONS

| SYMBOL | PARAMETER | UNITS | MIN | TYP | MAX |
|-----------------|----------------|-------|-----|-----|-----|
| V _{CC} | Supply Voltage | V | 4.5 | 5.0 | 5.5 |

TYPICAL PERFORMANCE CURVES (T_A = 25°C)

CIRCUIT CURRENT vs. VOLTAGE

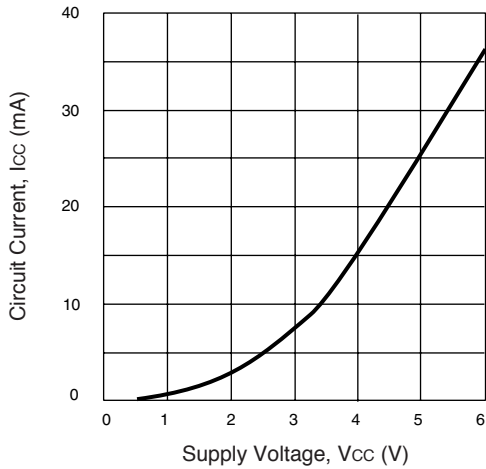

CIRCUIT CURRENT vs. TEMPERATURE

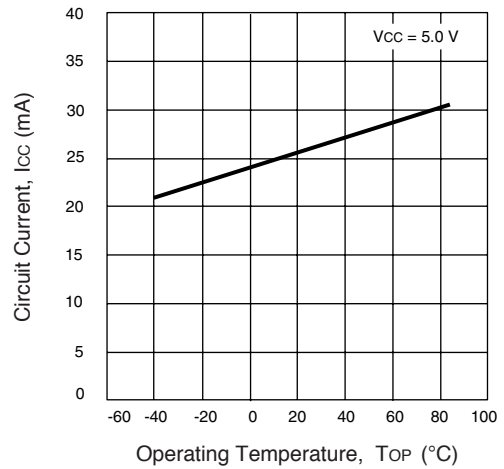

GAIN AND NOISE FIGURE vs. FREQUENCY AND VOLTAGE

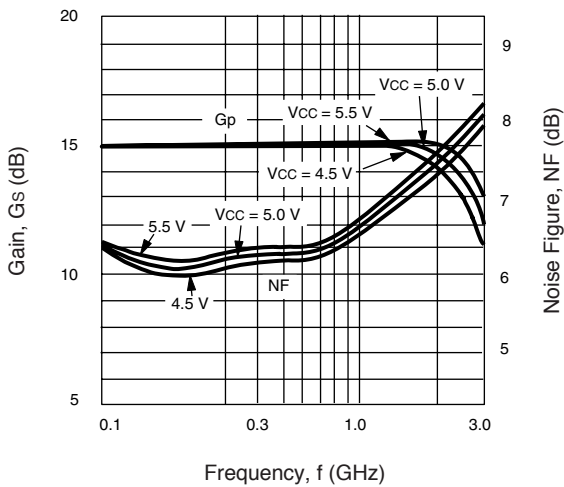

INPUT RETURN LOSS, OUTPUT RETURN LOSS vs. FREQUENCY

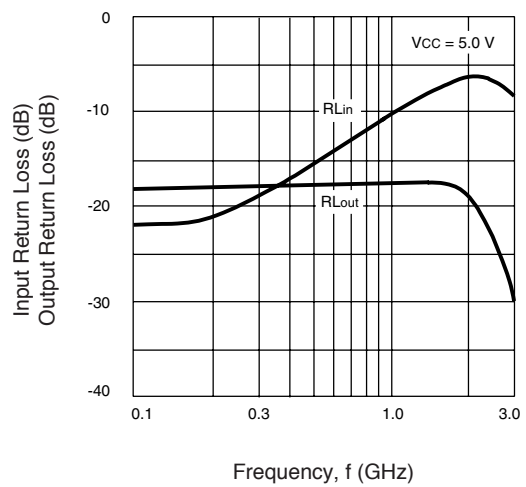

TYPICAL PERFORMANCE CURVES (TA = 25°C)

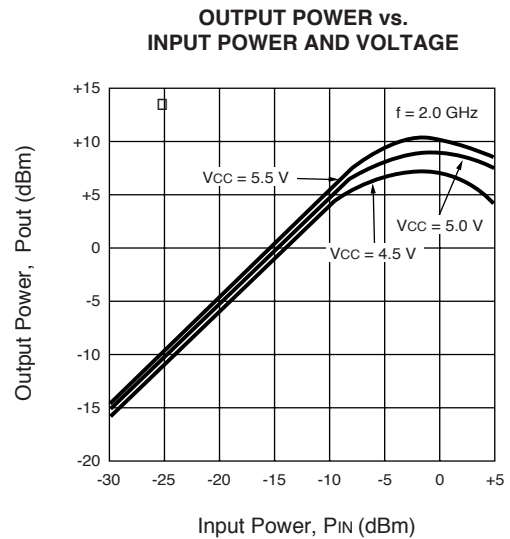
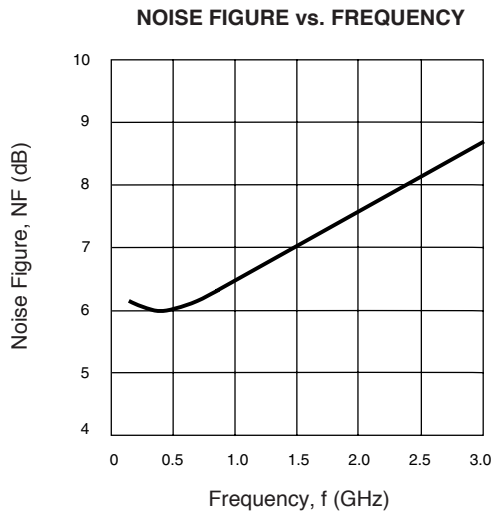
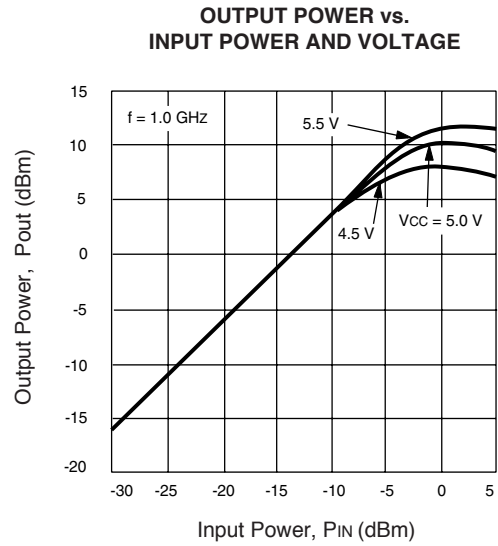
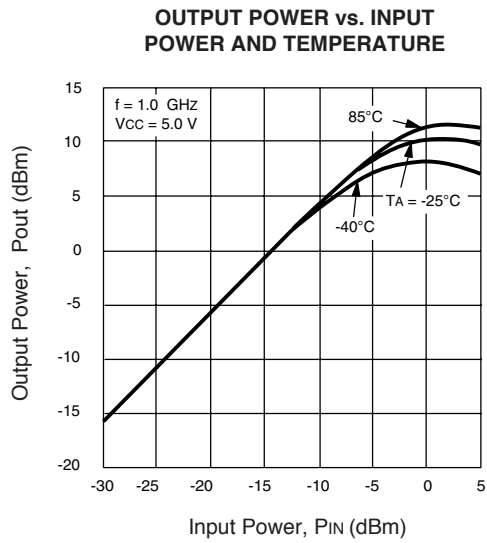
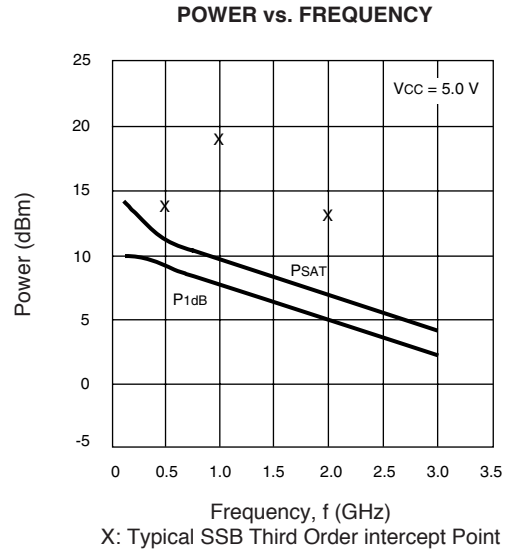
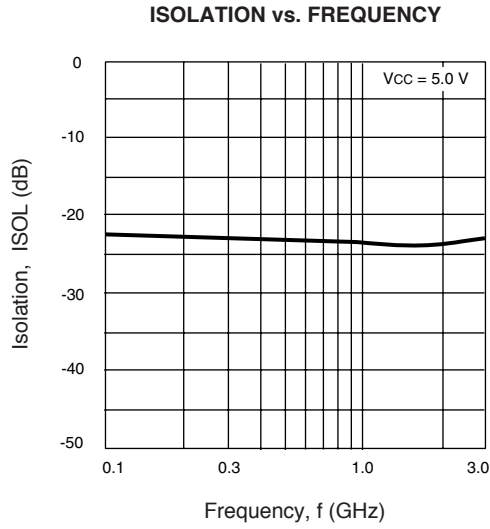

TYPICAL PERFORMANCE CURVES (T_A = 25°C)

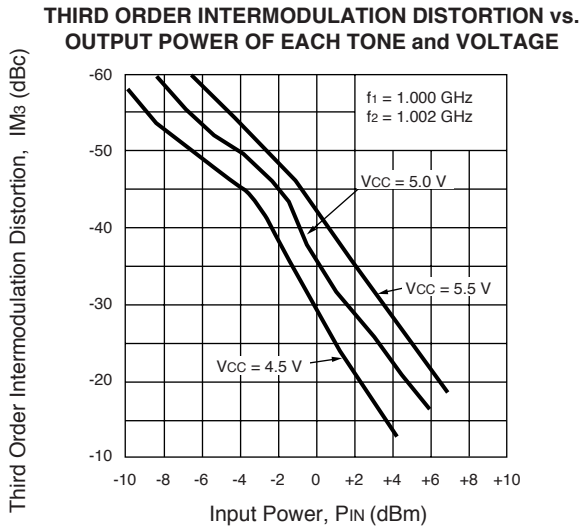
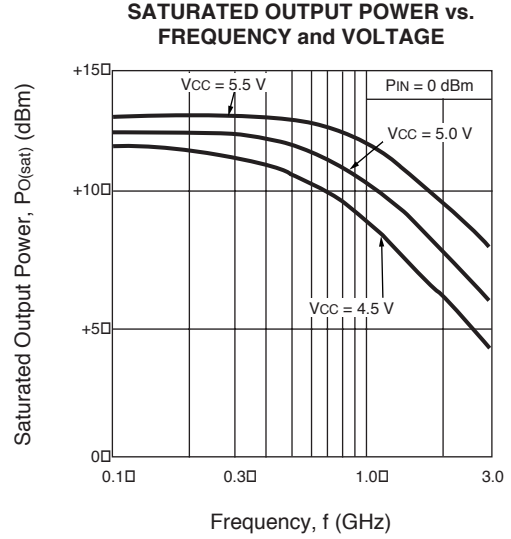
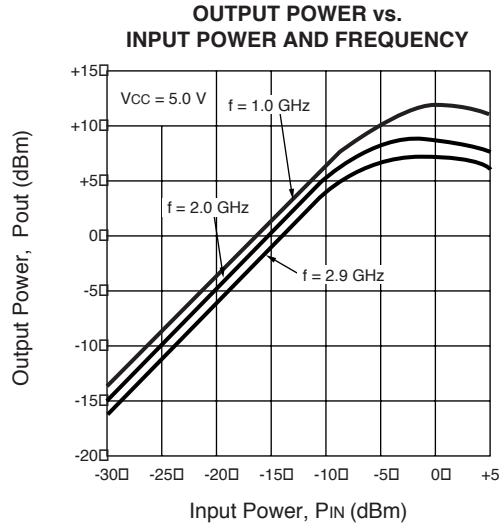

TYPICAL SCATTERING PARAMETERS ($T_A = 25^\circ\text{C}$, $V_{CC} = V_{OUT} = 5.0\text{ V}$)

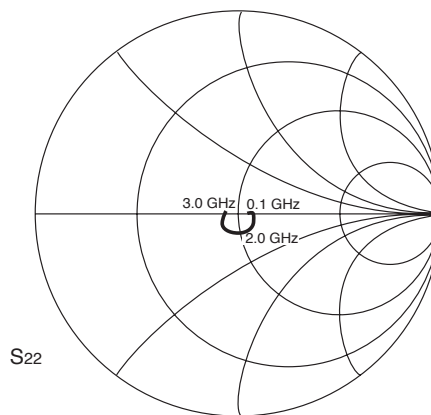
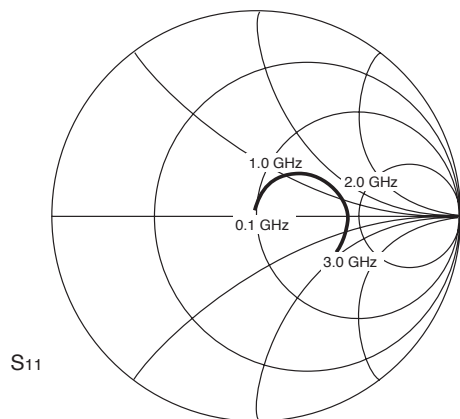

UPC2708TB

$V_{CC} = V_{OUT} = 5\text{ V}$, $I_{CC} = 27\text{ mA}$

| FREQUENCY GHz | S11 | | S21 | | S12 | | S22 | | K |
|------------------|-------|-------|-------|--------|-------|------|-------|--------|------|
| | MAG | ANG | MAG | ANG | MAG | ANG | MAG | ANG | |
| 0.1 | 0.039 | 138.9 | 5.815 | -4.8 | 0.077 | -0.8 | 0.051 | 0.9 | 1.34 |
| 0.2 | 0.053 | 119.7 | 5.822 | -9.8 | 0.075 | -1.5 | 0.048 | 1.4 | 1.36 |
| 0.3 | 0.069 | 106.7 | 5.815 | -14.3 | 0.074 | -0.6 | 0.049 | 5.9 | 1.38 |
| 0.4 | 0.088 | 97.2 | 5.813 | -18.8 | 0.074 | -0.5 | 0.054 | 8.9 | 1.36 |
| 0.5 | 0.105 | 91.6 | 5.794 | -23.8 | 0.072 | -1.1 | 0.054 | 8.8 | 1.39 |
| 0.6 | 0.123 | 84.9 | 5.823 | -28.4 | 0.071 | -0.6 | 0.056 | 10.4 | 1.40 |
| 0.7 | 0.144 | 79.7 | 5.871 | -33.0 | 0.070 | 0.1 | 0.060 | 11.5 | 1.40 |
| 0.8 | 0.164 | 74.7 | 5.890 | -38.2 | 0.071 | 0.5 | 0.065 | 11.6 | 1.37 |
| 0.9 | 0.186 | 70.7 | 5.938 | -42.8 | 0.073 | 2.3 | 0.072 | 11.1 | 1.34 |
| 1.0 | 0.205 | 66.1 | 5.960 | -47.6 | 0.070 | 4.4 | 0.082 | 5.6 | 1.31 |
| 1.1 | 0.226 | 61.7 | 6.072 | -52.7 | 0.069 | 5.0 | 0.091 | -4.6 | 1.28 |
| 1.2 | 0.245 | 57.7 | 6.097 | -57.5 | 0.070 | 4.4 | 0.082 | 5.6 | 1.31 |
| 1.3 | 0.263 | 53.7 | 6.174 | -63.0 | 0.067 | 2.5 | 0.085 | 0.6 | 1.33 |
| 1.4 | 0.286 | 48.6 | 6.275 | -68.4 | 0.069 | 5.0 | 0.091 | -4.6 | 1.28 |
| 1.5 | 0.308 | 44.3 | 6.371 | -74.3 | 0.070 | 5.4 | 0.092 | -8.2 | 1.24 |
| 1.6 | 0.328 | 40.7 | 6.419 | -79.8 | 0.066 | 7.1 | 0.097 | -12.6 | 1.26 |
| 1.7 | 0.344 | 36.2 | 6.470 | -85.9 | 0.067 | 5.6 | 0.096 | -19.6 | 1.23 |
| 1.8 | 0.364 | 31.0 | 6.555 | -92.1 | 0.069 | 8.2 | 0.100 | -23.9 | 1.18 |
| 1.9 | 0.382 | 26.0 | 6.542 | -98.3 | 0.070 | 8.4 | 0.092 | -8.2 | 1.24 |
| 2.0 | 0.395 | 21.2 | 6.570 | -104.7 | 0.070 | 8.7 | 0.101 | -38.9 | 1.13 |
| 2.1 | 0.405 | 16.8 | 6.528 | -111.3 | 0.070 | 10.1 | 0.100 | -47.2 | 1.12 |
| 2.2 | 0.417 | 11.8 | 6.527 | -118.5 | 0.071 | 9.4 | 0.096 | -57.2 | 1.09 |
| 2.3 | 0.427 | 6.6 | 6.438 | -124.7 | 0.072 | 9.5 | 0.098 | -66.1 | 1.09 |
| 2.4 | 0.431 | 2.2 | 6.336 | -131.3 | 0.071 | 10.7 | 0.095 | -76.5 | 1.09 |
| 2.5 | 0.431 | -3.0 | 6.247 | -138.1 | 0.072 | 12.8 | 0.098 | -86.1 | 1.09 |
| 2.6 | 0.434 | -8.2 | 6.127 | -145.0 | 0.071 | 15.4 | 0.094 | -99.9 | 1.10 |
| 2.7 | 0.423 | -12.3 | 5.952 | -151.7 | 0.071 | 14.5 | 0.088 | -116.7 | 1.14 |
| 2.8 | 0.419 | -17.1 | 5.816 | -158.2 | 0.070 | 16.1 | 0.081 | -134.4 | 1.18 |
| 2.9 | 0.408 | -21.5 | 5.619 | -165.0 | 0.073 | 15.3 | 0.074 | -149.7 | 1.19 |
| 3.0 | 0.400 | -26.2 | 5.354 | -171.5 | 0.074 | 17.1 | 0.065 | -170.3 | 1.24 |
| 3.1 | 0.386 | -29.3 | 5.134 | -177.4 | 0.075 | 17.1 | 0.053 | 172.8 | 1.28 |

PIN DESCRIPTIONS

| Pin No. | Symbol | Applied Voltage (V) | Pin Voltage (V) | Description | Internal Equivalent Circuit |
|-------------|--------|---------------------|-----------------|---|-----------------------------|
| 1 | Input | – | 1.16 | Signal input pin. An internal matching circuit, configured with resistors, enables 50 Ω connection over a wide bandwidth. A multi-feedback circuit is designed to cancel the deviations of hFE and resistance. This pin must be coupled to the signal source with a blocking capacitor. | |
| 4 | Output | – | – | Signal output pin. Connect an inductor between this pin and Vcc to supply current to the internal output transistors. | |
| 6 | Vcc | 4.5 to 5.5 | – | Power supply pin. This pin should be externally equipped with a bypass capacitor to minimize ground impedance. | |
| 2 3 5 | GND | 0 | – | Ground pins. These pins should be connected to system ground with minimum inductance. Ground pattern on the board should be formed as wide as possible. All the ground pins must be connected together with wide ground pattern to minimize impedance difference. | |

SYSTEM APPLICATION EXAMPLE

EXAMPLE OF DBS CONVERTERS

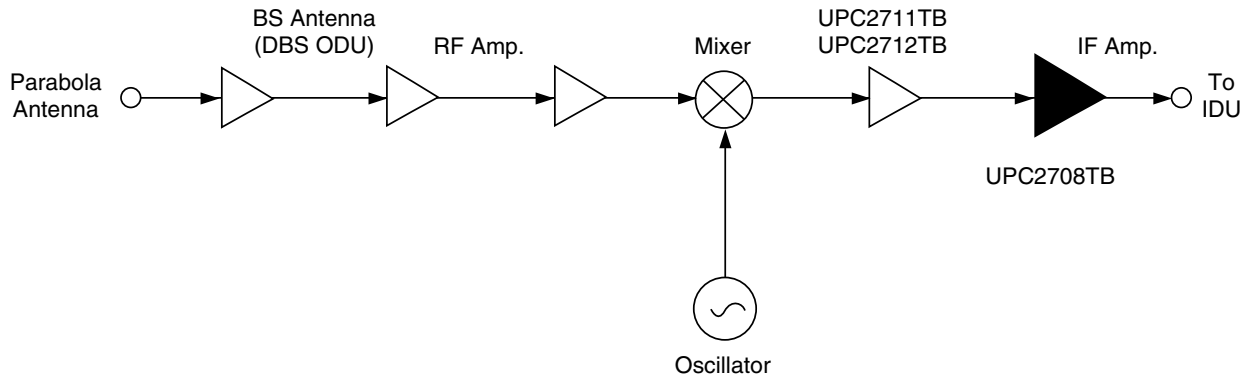

EXAMPLE OF 2.4 GHz BAND RECEIVER

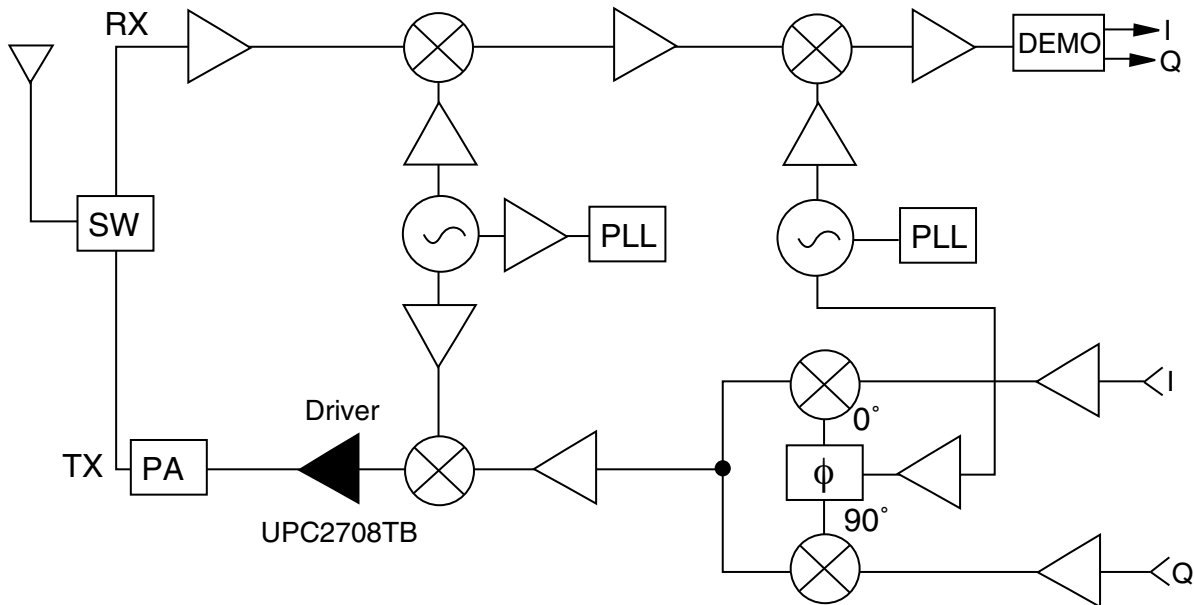

OUTLINE DIMENSIONS (Units in mm)

PACKAGE OUTLINE S06
(Top View)

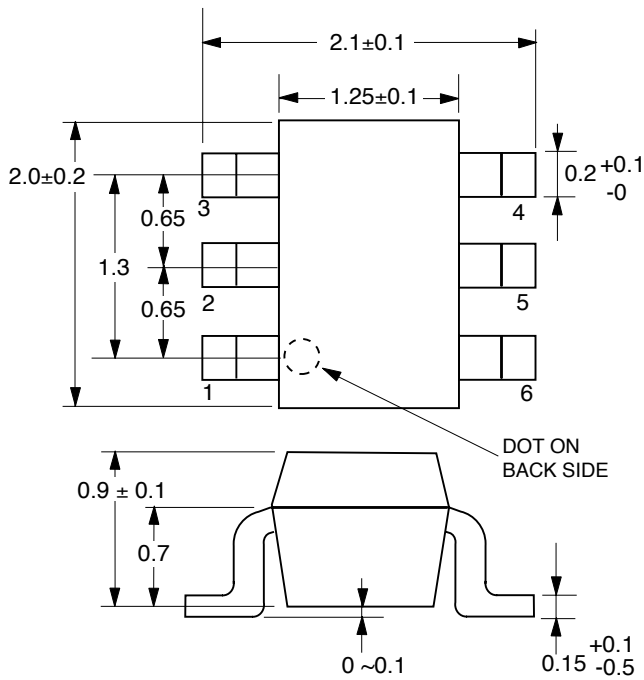

ORDERING INFORMATION

| PART NUMBER | MARKING | QTY |
|----------------|---------|---------|
| UPC2708TB-E3-A | C1D | 3K/Reel |

Note:
Embossed Tape, 8 mm wide. Pins 1, 2 and 3 face perforated side of tape.

TEST CIRCUIT

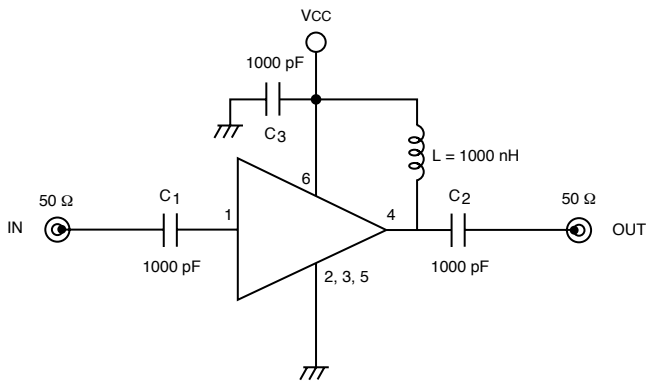

PIN CONNECTIONS

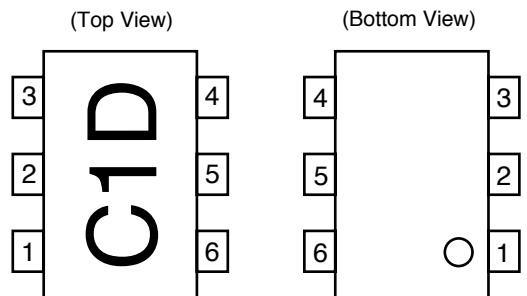

1. INPUT
2. GND
3. GND
4. OUTPUT
5. GND
6. VCC



Компания «ЭлектроПласт» предлагает заключение долгосрочных отношений при поставках импортных электронных компонентов на взаимовыгодных условиях!

Наши преимущества:

- Оперативные поставки широкого спектра электронных компонентов отечественного и импортного производства напрямую от производителей и с крупнейших мировых складов;
- Поставка более 17-ти миллионов наименований электронных компонентов;
- Поставка сложных, дефицитных, либо снятых с производства позиций;
- Оперативные сроки поставки под заказ (от 5 рабочих дней);
- Экспресс доставка в любую точку России;
- Техническая поддержка проекта, помощь в подборе аналогов, поставка прототипов;
- Система менеджмента качества сертифицирована по Международному стандарту ISO 9001;
- Лицензия ФСБ на осуществление работ с использованием сведений, составляющих государственную тайну;
- Поставка специализированных компонентов (Xilinx, Altera, Analog Devices, Intersil, Interpoint, Microsemi, Aeroflex, Peregrine, Syfer, Eurofarad, Texas Instrument, Miteq, Cobham, E2V, MA-COM, Hittite, Mini-Circuits, General Dynamics и др.);

Помимо этого, одним из направлений компании «ЭлектроПласт» является направление «Источники питания». Мы предлагаем Вам помощь Конструкторского отдела:

- Подбор оптимального решения, техническое обоснование при выборе компонента;
- Подбор аналогов;
- Консультации по применению компонента;
- Поставка образцов и прототипов;
- Техническая поддержка проекта;
- Защита от снятия компонента с производства.



Как с нами связаться

Телефон: 8 (812) 309 58 32 (многоканальный)

Факс: 8 (812) 320-02-42

Электронная почта: org@eplast1.ru

Адрес: 198099, г. Санкт-Петербург, ул. Калинина, дом 2, корпус 4, литера А.