

# SURFACE MOUNT LED WHITE, 2835 PACKAGE, 0.2W

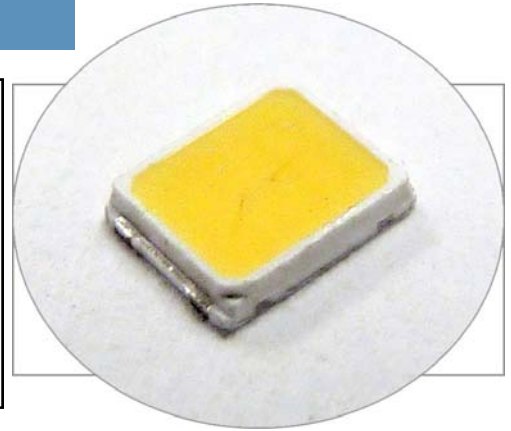

## SM2835UWDX02

- ◆ Industry Standard 2835 Package
- ◆ RoHS Compliant
- ◆ Small Package and Footprint
- ◆ X - (C) Cool White, (N) Neutral White, (W) Warm White
- ◆ Wide Viewing Angle
- ◆ Ideal for Lighting and Backlighting Application



Bivar Surface Mount 2835 package LED may be used in nearly any lighting or backlighting application. These 0.2 Watt SMD LED's have a minimum CRI Value of 80 and are available in 3 color temperatures to meet any illumination needs: Cool, Neutral and Warm White. The SM2835 Series is conveniently packaged in standard tape and reels for pick and place assemblies.

Part Number	Material	Emitted Color	Lens Color	Luminous Flux (lm) TYP.	Viewing Angle
SM2835UWDC02	InGaN	Cool White	Diffused	24	120°
SM2835UWDN02	InGaN	Neutral White	Diffused	23	120°
SM2835UWDW02	InGaN	Warm White	Diffused	22	120°

## Outline Dimensions

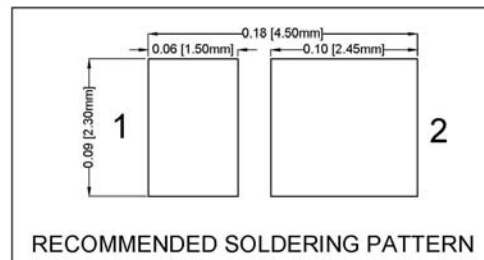
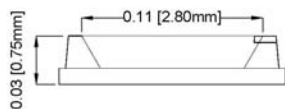
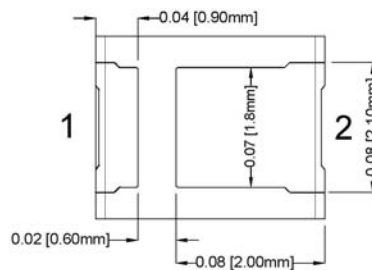
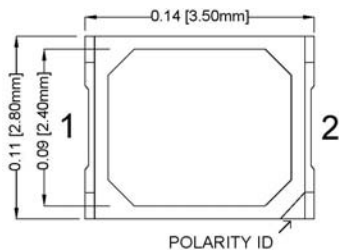

### Outline Drawings Notes:

1. All dimensions are in inches [millimeters].
2. Standard tolerance:  $\pm 0.010$ " unless otherwise noted.



Bivar reserves the right to make changes at any time without notice.

## Absolute Maximum Ratings

$T_A = 25^\circ\text{C}$  unless otherwise noted

Power Dissipation	0.26 W
Forward Current ( DC )	75 mA
Peak Forward Current <sup>1</sup>	120 mA
Reverse Voltage	5 V
Electrostatic Discharge (HBM)	2000 V
Operating Temperature Range	-40 ~ +100°C
Storage Temperature Range	-40 ~ +100°C
Junction Temperature	115°C
Lead Soldering Temperature <sup>2</sup>	260°C

Notes: 1.  $\leq 10\%$  Duty Cycle, Pulse Width  $\leq 0.1$  msec.  
2. Solder time less than 5 seconds at temperature extreme.

## Electrical / Optical Characteristics

$T_A = 25^\circ\text{C}$  &  $I_F = 60$  mA unless otherwise noted

Part Number	Forward Voltage (V)			Recommend Forward Current (mA)	Reverse Current ( $\mu\text{A}$ ) $V_R=5\text{V}$	CCT (Kelvin)			Luminous Flux (lm)			Viewing Angle $2\theta_{1/2}$ (deg)
	MIN	TYP	MAX	TYP	MAX	MIN	TYP	MAX	MIN	TYP	MAX	TYP
SM2835UWDC02	2.9	/	3.5	60	10	5800	6500	7300	20	24	28	120
SM2835UWDN02	2.9	/	3.5	60	10	3700	4000	4400	20	23	28	120
SM2835UWDW02	2.9	/	3.5	60	10	2750	3000	3150	20	22	26	120

Notes: 1. The above forward voltage measurement allowance tolerance is  $\pm 0.1\text{V}$ .  
2. The above luminous flux measurement allowance tolerance  $\pm 10\%$ .

# SURFACE MOUNT LED WHITE, 2835 PACKAGE, 0.2W



## Typical Electrical / Optical Characteristics

$T_A = 25^\circ\text{C}$  unless otherwise noted

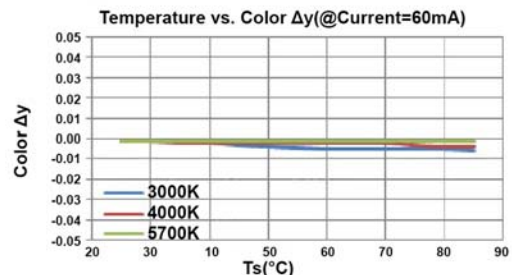
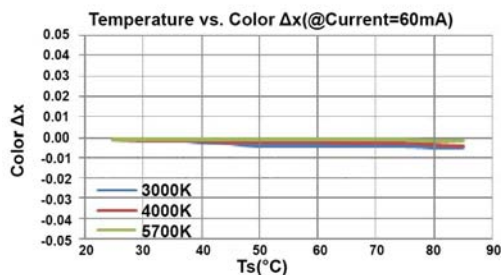
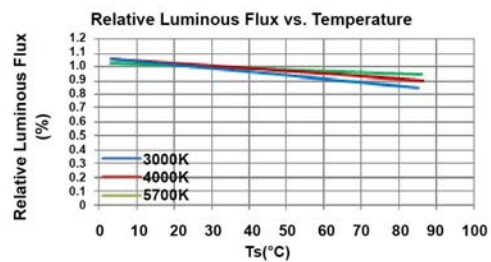
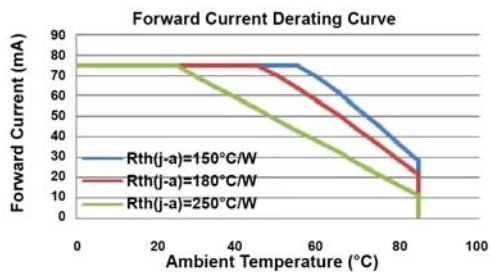
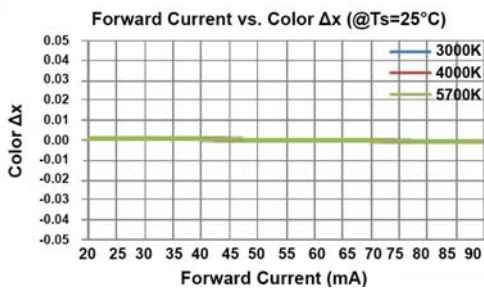
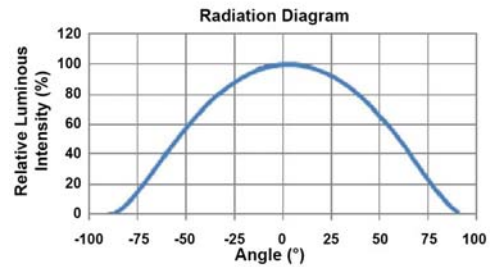
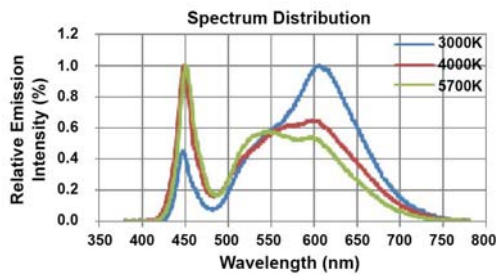
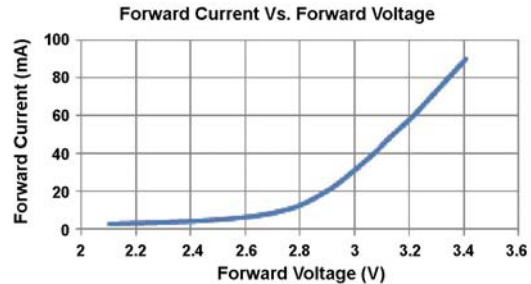
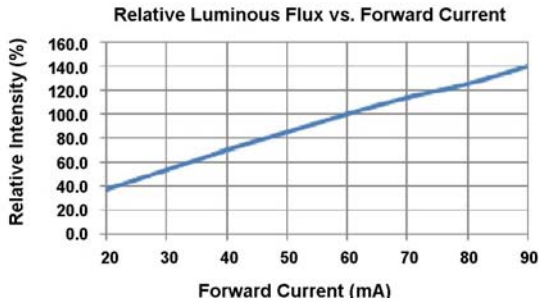

Bivar reserves the right to make changes at any time without notice.

# SURFACE MOUNT LED WHITE, 2835 PACKAGE, 0.2W



## Recommended Soldering Conditions

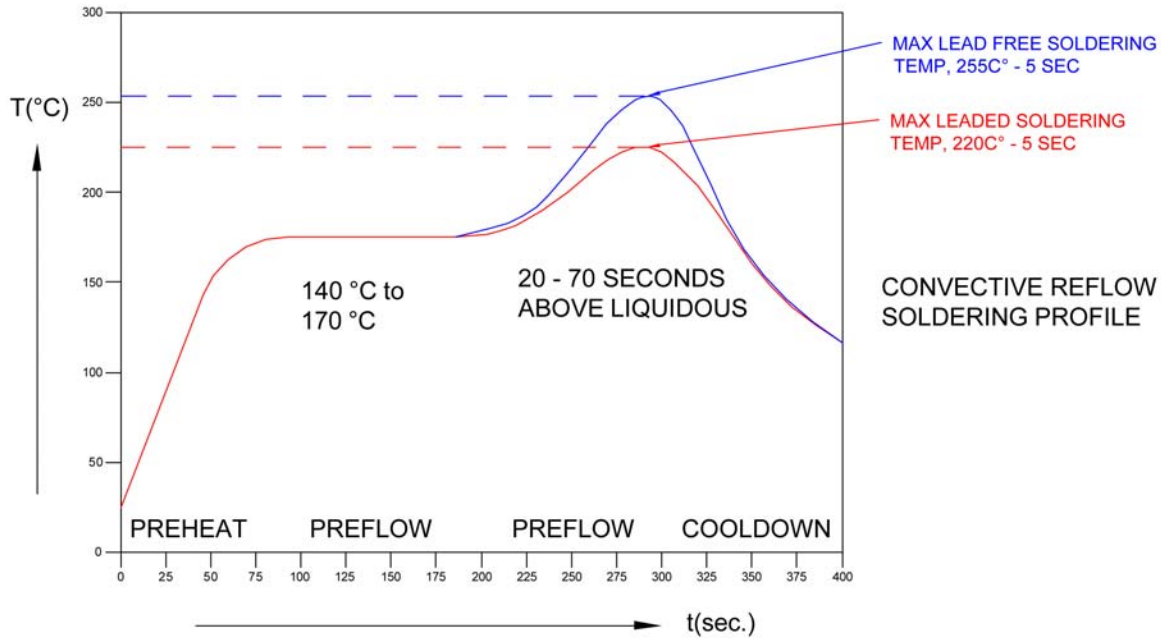

## Tape and Reel Dimensions

Note: 4000 pcs/Reel

### • Dimensions of Tape

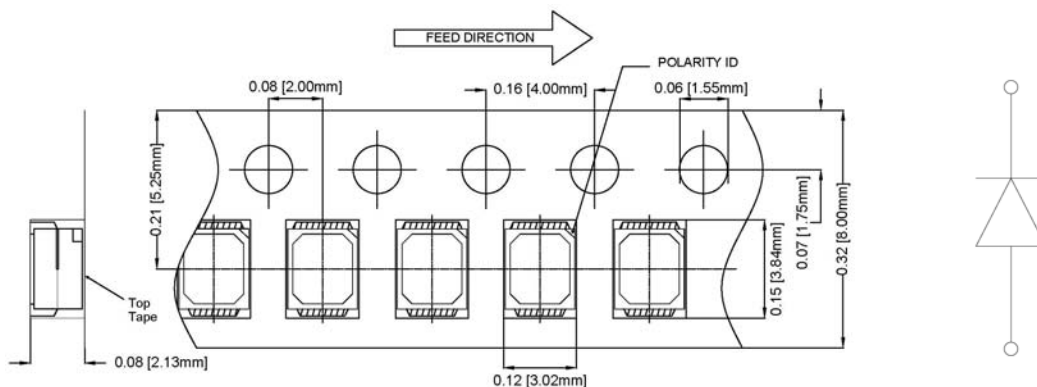

### • Arrangement of Tape

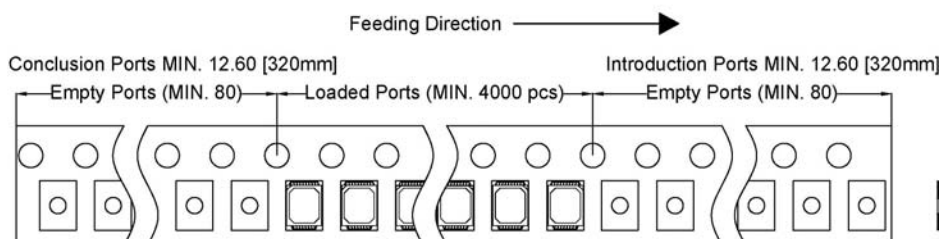

### Outline Drawings Notes:

1. All dimensions are in inches [millimeters].
2. Standard tolerance:  $\pm 0.010''$  unless otherwise noted.

Bivar reserves the right to make changes at any time without notice.

# SURFACE MOUNT LED WHITE, 2835 PACKAGE, 0.2W

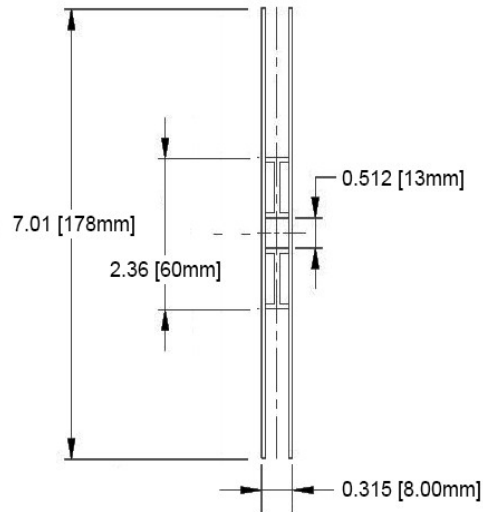
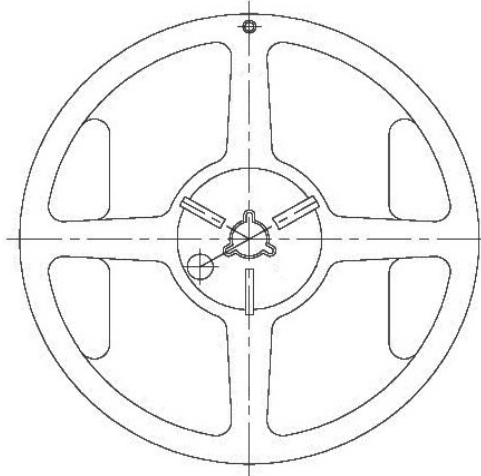

**Outline Drawings Notes:**

1. All dimensions are in inches [millimeters].
2. Standard tolerance unless otherwise noted: X.XXX ± 0.010"  
X.X ± 0.1"

## Packaging and Labeling Plan

Note: 1 Reel / Bag

Vacuum and Heat Sealed  
ESD/MBB Bag

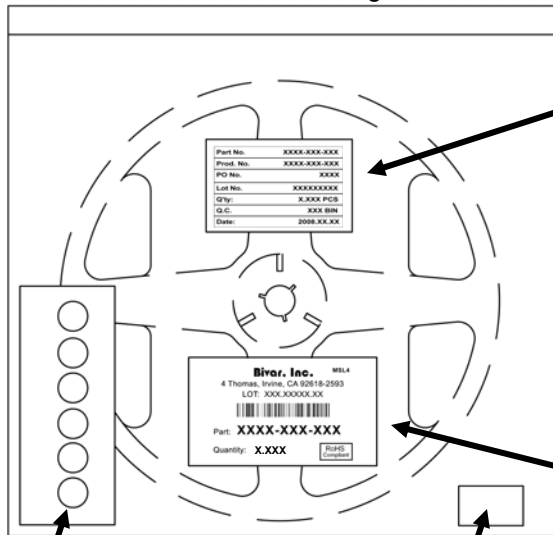

Humidity Indicator Card

Desiccants

Part No.	XXXX-XXX-XXX
Prod. No.	XXXX-XXX-XXX
PO No.	XXXX
Lot No.	XXXXXXXXXX
Q'ty:	X.XXX PCS
Q.C.	XXX BIN
Date:	2008.XX.XX

Internal Quality Control

**Bivar, Inc.** MSL4

4 Thomas, Irvine, CA 92618-2593  
LOT: XXX.XXXXX.XX



Part: **XXXX-XXX-XXX**

Quantity: **X.XXX**

RoHS  
Compliant

Bivar Standard Packaging Label

Bivar reserves the right to make changes at any time without notice.



Компания «ЭлектроПласт» предлагает заключение долгосрочных отношений при поставках импортных электронных компонентов на взаимовыгодных условиях!

Наши преимущества:

- Оперативные поставки широкого спектра электронных компонентов отечественного и импортного производства напрямую от производителей и с крупнейших мировых складов;
- Поставка более 17-ти миллионов наименований электронных компонентов;
- Поставка сложных, дефицитных, либо снятых с производства позиций;
- Оперативные сроки поставки под заказ (от 5 рабочих дней);
- Экспресс доставка в любую точку России;
- Техническая поддержка проекта, помощь в подборе аналогов, поставка прототипов;
- Система менеджмента качества сертифицирована по Международному стандарту ISO 9001;
- Лицензия ФСБ на осуществление работ с использованием сведений, составляющих государственную тайну;
- Поставка специализированных компонентов (Xilinx, Altera, Analog Devices, Intersil, Interpoint, Microsemi, Aeroflex, Peregrine, Syfer, Eurofarad, Texas Instrument, Miteq, Cobham, E2V, MA-COM, Hittite, Mini-Circuits, General Dynamics и др.);

Помимо этого, одним из направлений компании «ЭлектроПласт» является направление «Источники питания». Мы предлагаем Вам помощь Конструкторского отдела:

- Подбор оптимального решения, техническое обоснование при выборе компонента;
- Подбор аналогов;
- Консультации по применению компонента;
- Поставка образцов и прототипов;
- Техническая поддержка проекта;
- Защита от снятия компонента с производства.



#### Как с нами связаться

**Телефон:** 8 (812) 309 58 32 (многоканальный)

**Факс:** 8 (812) 320-02-42

**Электронная почта:** [org@eplast1.ru](mailto:org@eplast1.ru)

**Адрес:** 198099, г. Санкт-Петербург, ул. Калинина, дом 2, корпус 4, литера А.