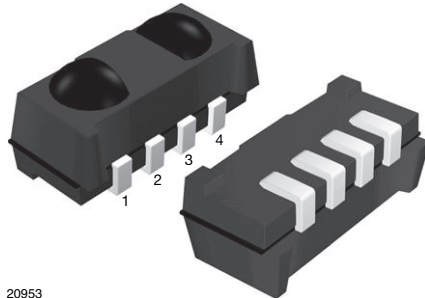


IR Receiver Modules for Remote Control Systems



20953

MECHANICAL DATA

Pinning:

 1, 4 = GND, 2 = V_S , 3 = OUT

ORDERING CODE

Taping:

TSOP75...TT - top view taped

TSOP75...TR - side view taped

FEATURES

- Very low supply current
- Photo detector and preamplifier in one package
- Compatible also with short burst dataformats
- Supply voltage: 2.5 V to 5.5 V
- Improved immunity against ambient light
- Capable of side or top view
- Two lenses for high sensitivity and wide receiving angle
- Insensitive to supply voltage ripple and noise
- Narrow optical filter to reduce interference from plasma TV emissions
- Material categorization: For definitions of compliance please see www.vishay.com/doc?99912



DESCRIPTION

The TSOP753.., TSOP755.. series are a two lens miniaturized receiver module for infrared remote control systems. One PIN diode per lens and a preamplifier are assembled on a leadframe, the epoxy lens cap is designed as an IR filter.

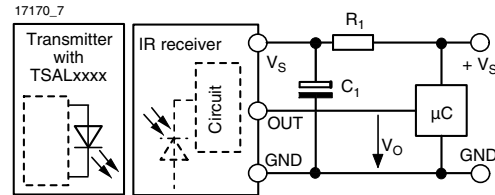
The demodulated output signal can be directly connected to a microprocessor for decoding. The TSOP753.. is optimized to better suppress spurious pulses from energy saving lamps. The TSOP755.. has an excellent noise suppression. It is immune to dimmed LCD backlighting and any fluorescent lamps. AGC3 and AGC5 may also suppress some data signals in case of continuous transmission.

This component has not been qualified according to automotive specifications.

| PARTS TABLE | | | |
|--------------------------|--------|--|---|
| AGC | | NOISY ENVIRONMENTS AND SHORT BURSTS (AGC3) | VERY NOISY ENVIRONMENTS AND SHORT BURSTS (AGC5) |
| Carrier frequency | 30 kHz | TSOP75330 | TSOP75530 |
| | 33 kHz | TSOP75333 | TSOP75533 |
| | 36 kHz | TSOP75336 ⁽¹⁾⁽²⁾ | TSOP75536 ⁽¹⁾⁽²⁾ |
| | 38 kHz | TSOP75338 ⁽³⁾⁽⁴⁾⁽⁵⁾⁽⁶⁾ | TSOP75538 ⁽³⁾⁽⁴⁾⁽⁵⁾ |
| | 40 kHz | TSOP75340 | TSOP75540 |
| | 56 kHz | TSOP75356 | TSOP75556 |
| Package | | Heimdall | |
| Pinning | | 1, 4 = GND, 2 = V_S , 3 = OUT | |
| Dimensions (mm) | | 6.8 W x 3.0 H x 3.2 D | |
| Mounting | | SMD | |
| Application | | Remote control | |
| Best remote control code | | ⁽¹⁾ MCIR ⁽²⁾ RCMM ⁽³⁾ Mitsubishi ⁽⁴⁾ RECS-80 Code ⁽⁵⁾ r-map ⁽⁶⁾ XMP-1, XMP-2 | |

BLOCK DIAGRAM


20445-1

APPLICATION CIRCUIT


The external components R_1 and C_1 are optional to improve the robustness against electrical overstress (typical values are $R_1 = 100 \Omega$, $C_1 = 0.1 \mu\text{F}$). The output voltage V_O should not be pulled down to a level below 1 V by the external circuit. The capacitive load at the output should be less than 2 nF.

ABSOLUTE MAXIMUM RATINGS

| PARAMETER | TEST CONDITION | SYMBOL | VALUE | UNIT |
|-----------------------------|------------------------------|-----------|-------------------------|------|
| Supply voltage | | V_S | -0.3 to +6 | V |
| Supply current | | I_S | 3 | mA |
| Output voltage | | V_O | -0.3 to ($V_S + 0.3$) | V |
| Output current | | I_O | 5 | mA |
| Junction temperature | | T_j | 100 | °C |
| Storage temperature range | | T_{stg} | -25 to +85 | °C |
| Operating temperature range | | T_{amb} | -25 to +85 | °C |
| Power consumption | $T_{amb} \leq 85 \text{ °C}$ | P_{tot} | 10 | mW |

Note

- Stresses beyond those listed under "Absolute Maximum Ratings" may cause permanent damage to the device. This is a stress rating only and functional operation of the device at these or any other conditions beyond those indicated in the operational sections of this specification is not implied. Exposure to absolute maximum rating conditions for extended periods may affect the device reliability.

ELECTRICAL AND OPTICAL CHARACTERISTICS ($T_{amb} = 25 \text{ °C}$, unless otherwise specified)

| PARAMETER | TEST CONDITION | SYMBOL | MIN. | TYP. | MAX. | UNIT |
|-----------------------|--|--------------------|------|----------|------|-----------------|
| Supply voltage | | V_S | 2.5 | | 5.5 | V |
| Supply current | $E_v = 0, V_S = 3.3 \text{ V}$ | I_{SD} | 0.27 | 0.35 | 0.45 | mA |
| | $E_v = 40 \text{ klx, sunlight}$ | I_{SH} | | 0.45 | | mA |
| Transmission distance | $E_v = 0$, test signal see fig. 1, IR diode TSAL6200, $I_F = 200 \text{ mA}$ | d | | 45 | | m |
| Output voltage low | $I_{OSL} = 0.5 \text{ mA}$, $E_e = 0.7 \text{ mW/m}^2$, test signal see fig. 1 | V_{OSL} | | | 100 | mV |
| Minimum irradiance | Pulse width tolerance: $t_{pi} - 5/f_o < t_{po} < t_{pi} + 6/f_o$, test signal see fig. 1 | $E_e \text{ min.}$ | | 0.12 | 0.25 | mW/m^2 |
| Maximum irradiance | $t_{pi} - 5/f_o < t_{po} < t_{pi} + 6/f_o$, test signal see fig. 1 | $E_e \text{ max.}$ | 30 | | | W/m^2 |
| Directivity | Angle of half transmission distance | $\phi_{1/2}$ | | ± 50 | | deg |

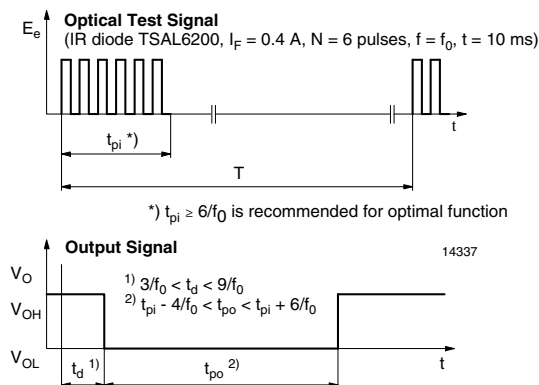
TYPICAL CHARACTERISTICS ($T_{amb} = 25 \text{ °C}$, unless otherwise specified)


Fig. 1 - Output Active Low

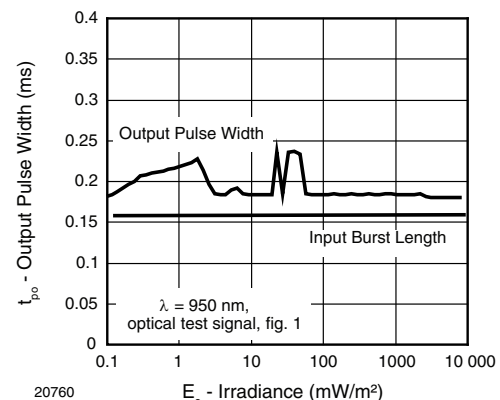


Fig. 2 - Pulse Length and Sensitivity in Dark Ambient



Fig. 3 - Output Function

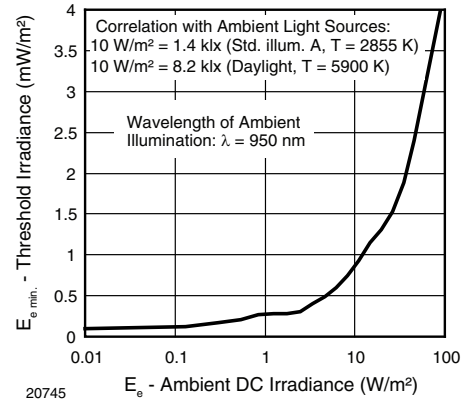


Fig. 6 - Sensitivity in Bright Ambient



Fig. 4 - Output Pulse Diagram



Fig. 7 - Sensitivity vs. Supply Voltage Disturbances



Fig. 5 - Frequency Dependence of Responsivity



Fig. 8 - Max. Envelope Duty Cycle vs. Burst Length



Fig. 9 - Sensitivity vs. Ambient Temperature



Fig. 12 - Vertical Directivity



Fig. 10 - Relative Spectral Sensitivity vs. Wavelength



Fig. 13 - Sensitivity vs. Supply Voltage



Fig. 11 - Horizontal Directivity

SUITABLE DATA FORMAT

The TSOP753.., TSOP755.. series are designed to suppress spurious output pulses due to noise or disturbance signals. Data and disturbance signals can be distinguished by the devices according to carrier frequency, burst length and envelope duty cycle. The data signal should be close to the band-pass center frequency (e.g. 38 kHz) and fulfill the conditions in the table below.

When a data signal is applied to the TSOP753.. and TSOP755.. in the presence of a disturbance signal, the sensitivity of the receiver is reduced to insure that no spurious pulses are present at the output. Some examples of disturbance signals which are suppressed are:

- DC light (e.g. from tungsten bulb or sunlight)
- Continuous signals at any frequency
- Strongly or weakly modulated pattern from fluorescent lamps with electronic ballasts (see fig. 14 or fig. 15)



Fig. 14 - IR Disturbance from Fluorescent Lamp with Low Modulation



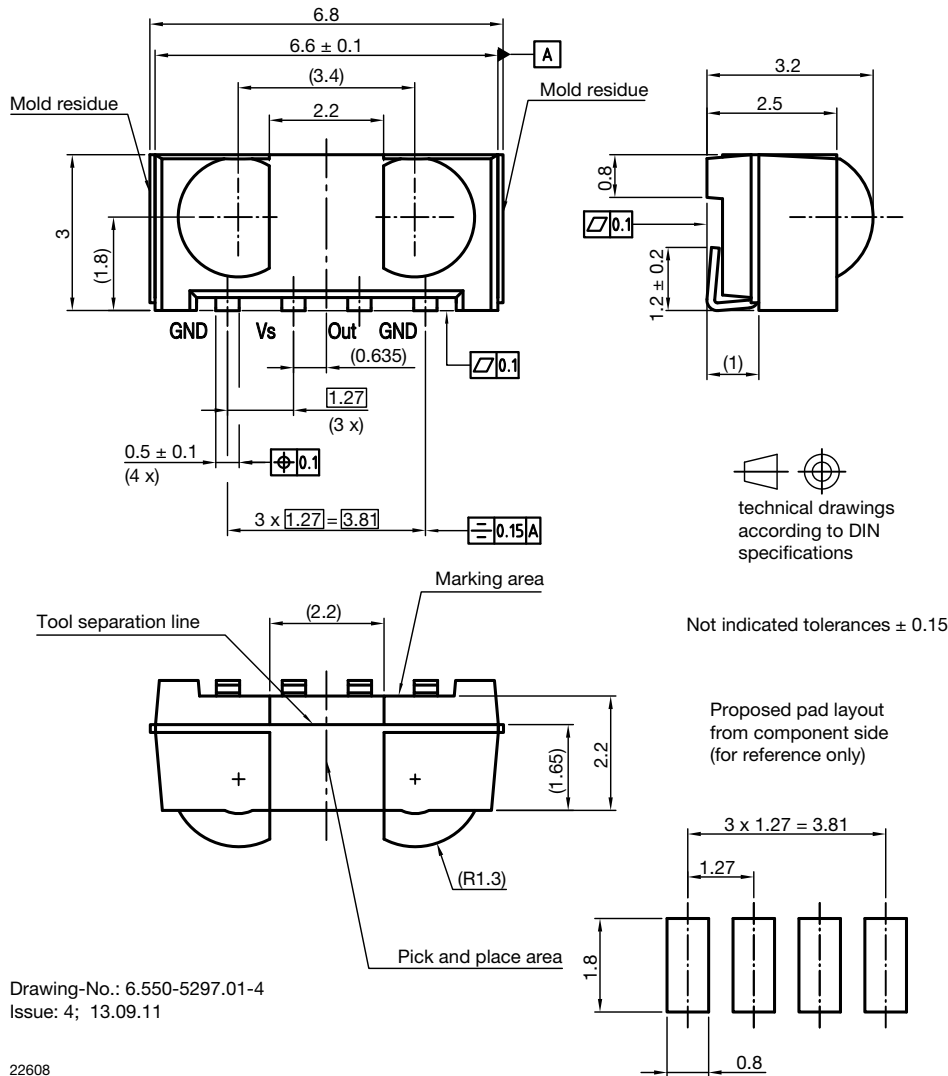
Fig. 15 - IR Disturbance from Fluorescent Lamp with High Modulation

| | TSOP753.. | TSOP755.. |
|--|---|---|
| Minimum burst length | 6 cycles/burst | 6 cycles/burst |
| After each burst of length a minimum gap time is required of | 6 to 35 cycles ≥ 10 cycles | 6 to 24 cycles ≥ 10 cycles |
| For bursts greater than a minimum gap time in the data stream is needed of | 35 cycles > 4 x burst length | 24 cycles > 25 ms |
| Maximum number of continuous short bursts/second | 2000 | 2000 |
| MCIR code | preferred | yes |
| RCMM code | preferred | yes |
| XMP-1, XMP-2 code | preferred | yes |
| Suppression of interference from fluorescent lamps | Most common disturbance patterns are suppressed | Most common disturbance patterns are suppressed |

Notes

- For data formats with long bursts please see the datasheet for TSOP752.., TSOP754..
- Best choice of AGC for some popular IR-codes:
 - TSOP75336: MCIR, RCMM
 - TSOP75538: Mitsubishi, RECS-80 Code
 - TSOP75338: XMP-1, XMP-2, r-map
- For SIRCS 15 and 20 bit, Sony 12 bit IR-codes, please see the datasheet for TSOP75S40F

PACKAGE DIMENSIONS in millimeters



Drawing-No.: 6.550-5297.01-4
Issue: 4; 13.09.11

22608

ASSEMBLY INSTRUCTIONS

Reflow Soldering

- Reflow soldering must be done within 72 h while stored under a max. temperature of 30 °C, 60 % RH after opening the dry pack envelope
- Set the furnace temperatures for pre-heating and heating in accordance with the reflow temperature profile as shown in the diagram. Exercise extreme care to keep the maximum temperature below 260 °C. The temperature shown in the profile means the temperature at the device surface. Since there is a temperature difference between the component and the circuit board, it should be verified that the temperature of the device is accurately being measured
- Handling after reflow should be done only after the work surface has been cooled off

Manual Soldering

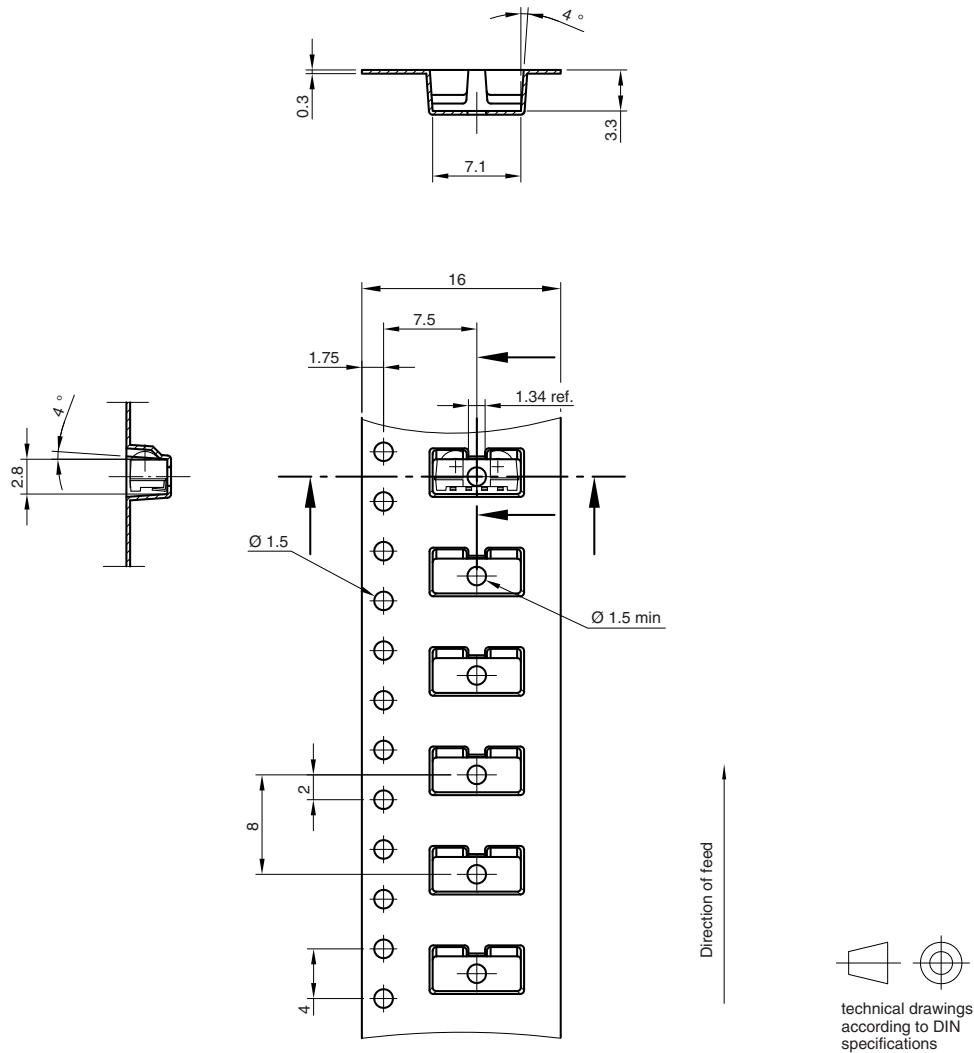
- Use a soldering iron of 25 W or less. Adjust the temperature of the soldering iron below 300 °C
- Finish soldering within 3 s
- Handle products only after the temperature has cooled off



VISHAY LEAD (Pb)-FREE REFLOW SOLDER PROFILE



TAPING VERSION TSOP..TR DIMENSIONS in millimeters



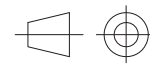
Drawing-No.: 9.700-5337.01-4
Issue: 1; 16.10.08
21577



TAPING VERSION TSOP..TT DIMENSIONS in millimeters



Drawing-No.: 9.700-5338.01-4
Issue: 3; 09.06.09
21578



technical drawings
according to DIN
specifications



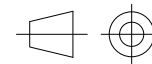
REEL DIMENSIONS in millimeters



Form of the leave open of the wheel is supplier specific.

Dimension acc. to IEC EN 60 286-3

Tape width 16



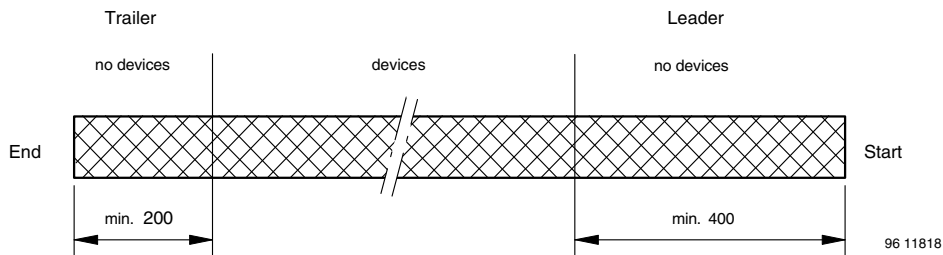
technical drawings according to DIN specifications

Drawing-No.: 9.800-5052.V2-4

Issue: 1; 07.05.02

16734

LEADER AND TRAILER DIMENSIONS in millimeters



COVER TAPE PEEL STRENGTH

According to DIN EN 60286-3

0.1 N to 1.3 N

300 ± 10 mm/min.

165° to 180° peel angle

LABEL

Standard bar code labels for finished goods

The standard bar code labels are product labels and used for identification of goods. The finished goods are packed in final packing area. The standard packing units are labeled with standard bar code labels before transported as finished goods to warehouses. The labels are on each packing unit and contain Vishay Semiconductor GmbH specific data.

| VISHAY SEMICONDUCTOR GmbH STANDARD BAR CODE PRODUCT LABEL (Finished goods) | | |
|---|---------------------|---------------|
| PLAIN WRITING | ABBREVIATION | LENGTH |
| Item-description | - | 18 |
| Item-number | INO | 8 |
| Selection-code | SEL | 3 |
| LOT-/serial-number | BATCH | 10 |
| Data-code | COD | 3 (YWW) |
| Plant-code | PTC | 2 |
| Quantity | QTY | 8 |
| Accepted by | ACC | - |
| Packed by | PCK | - |
| Mixed code indicator | MIXED CODE | - |
| Origin | xxxxxxx+ | Company logo |
| LONG BAR CODE TOP | TYPE | LENGTH |
| Item-number | N | 8 |
| Plant-code | N | 2 |
| Sequence-number | X | 3 |
| Quantity | N | 8 |
| Total length | - | 21 |
| SHORT BAR CODE BOTTOM | TYPE | LENGTH |
| Selection-code | X | 3 |
| Data-code | N | 3 |
| Batch-number | X | 10 |
| Filter | - | 1 |
| Total length | - | 17 |

DRY PACKING

The reel is packed in an anti-humidity bag to protect the devices from absorbing moisture during transportation and storage.



FINAL PACKING

The sealed reel is packed into a cardboard box. A secondary cardboard box is used for shipping purposes.

RECOMMENDED METHOD OF STORAGE

Dry box storage is recommended as soon as the aluminum bag has been opened to prevent moisture absorption. The following conditions should be observed, if dry boxes are not available:

- Storage temperature 10 °C to 30 °C
- Storage humidity ≤ 60 % RH max.

After more than 72 h under these conditions moisture content will be too high for reflow soldering.

In case of moisture absorption, the devices will recover to the former condition by drying under the following condition:
 192 h at 40 °C + 5 °C / - 0 °C and < 5 % RH (dry air/nitrogen) or
 96 h at 60 °C + 5 °C and < 5 % RH for all device containers or
 24 h at 125 °C + 5 °C not suitable for reel or tubes.

An EIA JEDEC® standard J-STD-020 level 4 label is included on all dry bags.



EIA JEDEC standard J-STD-020 level 4 label is included on all dry bags



ESD PRECAUTION

Proper storage and handling procedures should be followed to prevent ESD damage to the devices especially when they are removed from the antistatic shielding bag. Electro-static sensitive devices warning labels are on the packaging.

VISHAY SEMICONDUCTORS STANDARD BAR CODE LABELS

The Vishay Semiconductors standard bar code labels are printed at final packing areas. The labels are on each packing unit and contain Vishay Semiconductors specific data.

BAR CODE PRODUCT LABEL (Example)



22178



Disclaimer

ALL PRODUCT, PRODUCT SPECIFICATIONS AND DATA ARE SUBJECT TO CHANGE WITHOUT NOTICE TO IMPROVE RELIABILITY, FUNCTION OR DESIGN OR OTHERWISE.

Vishay Intertechnology, Inc., its affiliates, agents, and employees, and all persons acting on its or their behalf (collectively, "Vishay"), disclaim any and all liability for any errors, inaccuracies or incompleteness contained in any datasheet or in any other disclosure relating to any product.

Vishay makes no warranty, representation or guarantee regarding the suitability of the products for any particular purpose or the continuing production of any product. To the maximum extent permitted by applicable law, Vishay disclaims (i) any and all liability arising out of the application or use of any product, (ii) any and all liability, including without limitation special, consequential or incidental damages, and (iii) any and all implied warranties, including warranties of fitness for particular purpose, non-infringement and merchantability.

Statements regarding the suitability of products for certain types of applications are based on Vishay's knowledge of typical requirements that are often placed on Vishay products in generic applications. Such statements are not binding statements about the suitability of products for a particular application. It is the customer's responsibility to validate that a particular product with the properties described in the product specification is suitable for use in a particular application. Parameters provided in datasheets and/or specifications may vary in different applications and performance may vary over time. All operating parameters, including typical parameters, must be validated for each customer application by the customer's technical experts. Product specifications do not expand or otherwise modify Vishay's terms and conditions of purchase, including but not limited to the warranty expressed therein.

Except as expressly indicated in writing, Vishay products are not designed for use in medical, life-saving, or life-sustaining applications or for any other application in which the failure of the Vishay product could result in personal injury or death. Customers using or selling Vishay products not expressly indicated for use in such applications do so at their own risk. Please contact authorized Vishay personnel to obtain written terms and conditions regarding products designed for such applications.

No license, express or implied, by estoppel or otherwise, to any intellectual property rights is granted by this document or by any conduct of Vishay. Product names and markings noted herein may be trademarks of their respective owners.

Material Category Policy

Vishay Intertechnology, Inc. hereby certifies that all its products that are identified as RoHS-Compliant fulfill the definitions and restrictions defined under Directive 2011/65/EU of The European Parliament and of the Council of June 8, 2011 on the restriction of the use of certain hazardous substances in electrical and electronic equipment (EEE) - recast, unless otherwise specified as non-compliant.

Please note that some Vishay documentation may still make reference to RoHS Directive 2002/95/EC. We confirm that all the products identified as being compliant to Directive 2002/95/EC conform to Directive 2011/65/EU.

Vishay Intertechnology, Inc. hereby certifies that all its products that are identified as Halogen-Free follow Halogen-Free requirements as per JEDEC JS709A standards. Please note that some Vishay documentation may still make reference to the IEC 61249-2-21 definition. We confirm that all the products identified as being compliant to IEC 61249-2-21 conform to JEDEC JS709A standards.



Компания «ЭлектроПласт» предлагает заключение долгосрочных отношений при поставках импортных электронных компонентов на взаимовыгодных условиях!

Наши преимущества:

- Оперативные поставки широкого спектра электронных компонентов отечественного и импортного производства напрямую от производителей и с крупнейших мировых складов;
- Поставка более 17-ти миллионов наименований электронных компонентов;
- Поставка сложных, дефицитных, либо снятых с производства позиций;
- Оперативные сроки поставки под заказ (от 5 рабочих дней);
- Экспресс доставка в любую точку России;
- Техническая поддержка проекта, помощь в подборе аналогов, поставка прототипов;
- Система менеджмента качества сертифицирована по Международному стандарту ISO 9001;
- Лицензия ФСБ на осуществление работ с использованием сведений, составляющих государственную тайну;
- Поставка специализированных компонентов (Xilinx, Altera, Analog Devices, Intersil, Interpoint, Microsemi, Aeroflex, Peregrine, Syfer, Eurofarad, Texas Instrument, Miteq, Cobham, E2V, MA-COM, Hittite, Mini-Circuits, General Dynamics и др.);

Помимо этого, одним из направлений компании «ЭлектроПласт» является направление «Источники питания». Мы предлагаем Вам помощь Конструкторского отдела:

- Подбор оптимального решения, техническое обоснование при выборе компонента;
- Подбор аналогов;
- Консультации по применению компонента;
- Поставка образцов и прототипов;
- Техническая поддержка проекта;
- Защита от снятия компонента с производства.



Как с нами связаться

Телефон: 8 (812) 309 58 32 (многоканальный)

Факс: 8 (812) 320-02-42

Электронная почта: org@eplast1.ru

Адрес: 198099, г. Санкт-Петербург, ул. Калинина, дом 2, корпус 4, литера А.